

ARTICLES CONTAINED IN THIS ISSUE

CODE	ARTICLE.....	PAGE
(00)	New STIS Releases from 12/01/2012 to 12/31/2012 ...	6
(01)	Additional Tie-Down Plug for 2012-13 Impreza Models	1
(09)	Air Fuel Ratio Sensor and Oxygen Sensor Removal	2
(12)	Windshield Cracks on the Inside, a Reminder	5
(14)	SDI Interface Box and Self Shut Timer	2
(14)	2014 Forester Select Monitor Operation	2
(15)	2013 Legacy/Outback Navigation System Volume Adjustment	3
(15)	WVX-34 Reminder	4
(15)	Wheel Locks	5
(18)	WQA-37 Information	3

01

ADDITIONAL TIE-DOWN PLUG FOR 2012-13 IMPREZA AND XV CROSSTREK™ MODELS

Beginning with the VIN numbers listed in the chart below, additional plugs to be installed during PDI into the tie-down holes will be included with the plug set found in the glove box. These additional plugs will help prevent dust intrusion into the vehicle. The illustration provides the location ahead of the rear wheel arch on both sides of the vehicle. If needed, the plugs are available separately by ordering part number 90371CA010.

MODEL	TYPE	STARTING VIN NUMBER
Impreza and XV Crosstrek	4-Door	010889
	5-Door	802448

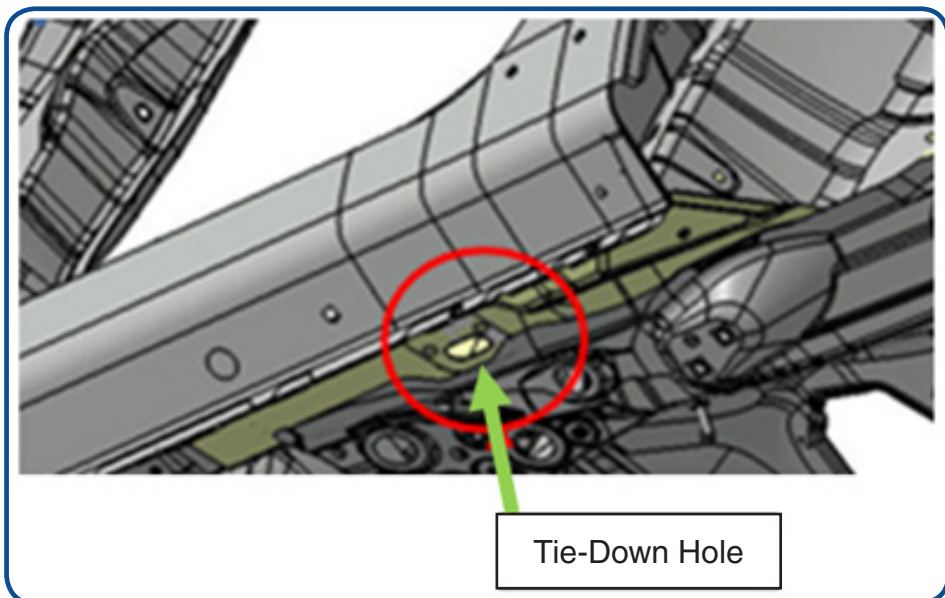

CAUTION: VEHICLE SERVICING PERFORMED BY UNTRAINED PERSONS COULD RESULT IN SERIOUS INJURY TO THOSE PERSONS OR TO OTHERS.

The Subaru TechTIPS newsletter is intended for use by professional technicians ONLY. Articles are written to inform those technicians of conditions that may occur in some vehicles, or to provide information that could assist in the proper servicing of the vehicle. Properly trained technicians have the equipment, tools, safety instructions, and know-how to do the job correctly and safely. If a condition is described, DO NOT assume that your vehicle has or will have that condition. Impreza, Legacy, Justy, Loyale, Outback, Forester, Subaru SVX, WRX, WRX STI, L.L. Bean, Baja, Tribeca, BRZ, XV Crosstrek and "Quality Driven" are Registered Trademarks.

**SUBARU OF AMERICA, INC. IS
"ISO 14001 COMPLIANT"**

The international standard for excellence in Environmental Management Systems. Please recycle or dispose of automotive products in a manner that is friendly to our environment and in accordance with all local, state and federal laws and regulations.



QUALITY DRIVEN® SERVICE



09 AIR FUEL RATIO SENSOR AND OXYGEN SENSOR REMOVAL

When replacing a catalytic converter on any model, the A/F sensor and/or Oxygen sensor can be reused in most cases. After the converter has cooled down, spray the threaded portion of the sensor with penetrating oil and allow it to soak for at least one minute or more. Remove the sensor using appropriate special tool or box wrench. When installing the new sensor always apply a small amount of anti seize compound to the threaded portion only prior to installation. Torque the sensor to the proper specification (15.5 ft-lbs).

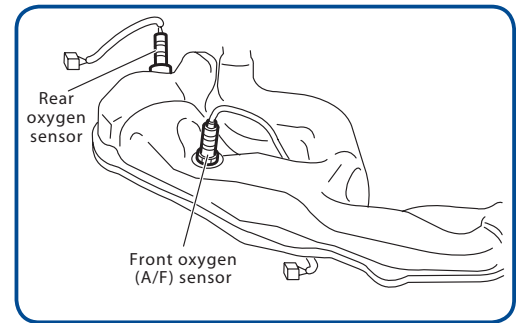

14 SDI INTERFACE BOX AND SELF SHUT TIMER

Should you have an SDI Interface Box that keeps powering down after 30 minutes or less, particularly a loaner unit from Nuispire, you must change the self shut timer to “OFF”. There is a very good chance that an ECM will be damaged if this happens during a system reflash. To access the menu to change your timer settings follow the procedure below.

- There are 4 choices to choose from in the self shut timer menu, 2 minutes, 10 minutes, 30 minutes or off
- Hold down the Menu and C keys to put the SDI box in standalone mode
- From the main menu screen choose function set up
- Scroll all the way down to the bottom using the up/down arrow keys
- Select self shut timer
- To change the time use the up/down arrow keys and make your selection. It is best to set it to off so there is no chance of timing out during a test or a reflash

14 2014 FORESTER SELECT MONITOR OPERATION

If you plug either the SDI box or Subaru Select Monitor in to a 2014 Forester and your current version is December 2012 or prior, it is possible to render the Rear Power Tailgate inoperative if you do not properly cycle the ignition switch off and on. You may also set a code B2514 (Power Tailgate Ignition Failure). To check your version of software, click on the Help button and “About Application” from the main menu screen of the Select Monitor. The Power Tailgate does not have a warning light in the combination meter. This code would appear in the Power Rear Gate Control Module. If this code is stored in memory perform “Clear Memory Mode”. Select Monitors that are updated to the current January 2013 version should not encounter this condition.

18 WQA-37 INFORMATION

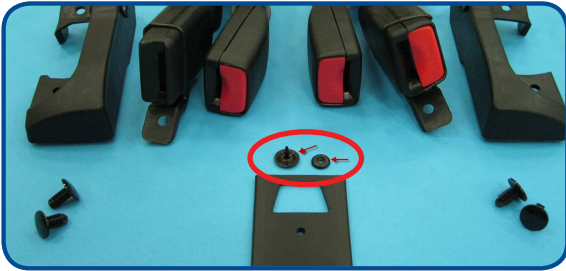

Please be advised of the following kit part numbers 64665SC040AP and 64665SC040AR both contain a Tack for the rear seatbelt. If this tack is broken during installation it is available separately under part number 64715SC060AP or 64715SC060AR. Please direct any parts related questions to the Parts Information Coordinators.

15 2013 LEGACY / OUTBACK, NAVIGATION SYSTEM VOLUME ADJUSTMENT

In the event you receive a customer inquiry or concern about adjusting the volume of the voice guidance on their navigation system, the following steps and screen shots will make it easy to adjust. This will help to clarify the procedure in the 2013 Legacy / Outback Navigation System Owner Manual. Feel free to copy and provide this information to your customers as needed. The initial volume setting has been changed (lowered) during production starting in January, 2013.

Step 1 - Push the MAP button to display the map screen.



Step 2 - Push the MENU button.

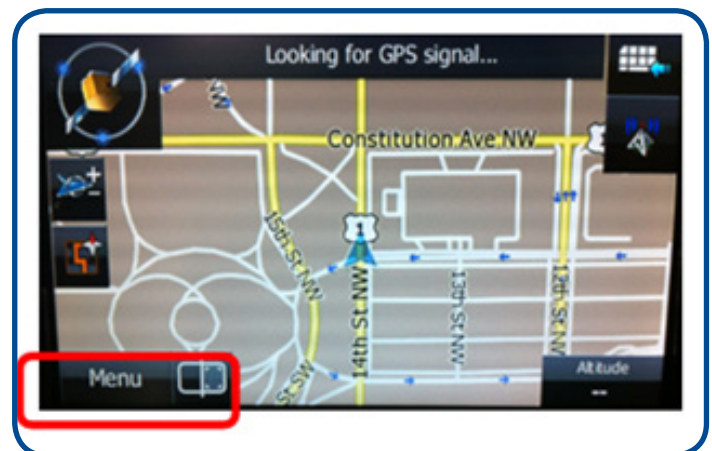

Step 3 - Press the MORE button (the vehicle must be stopped for this button to be active).

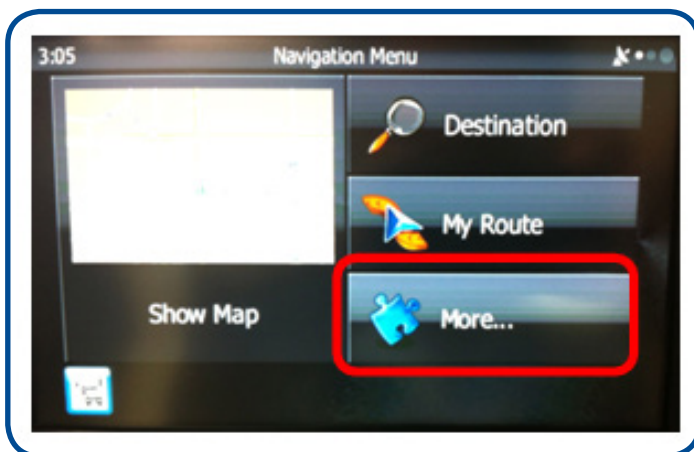

Step 4 - Press the SETTINGS button.

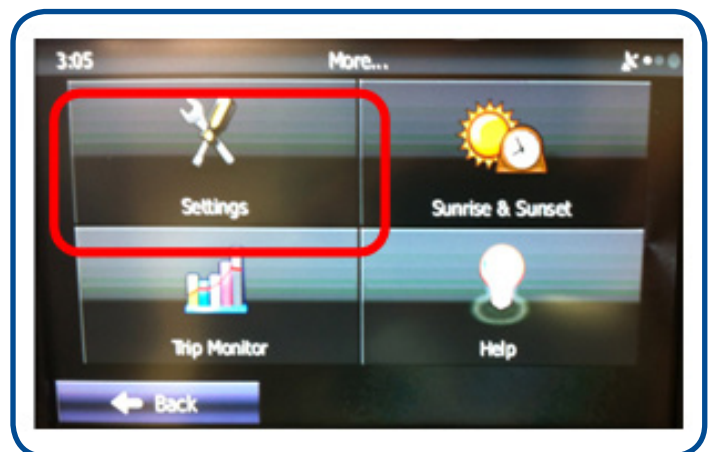

15 2013 LEGACY / OUTBACK, NAVIGATION SYSTEM VOLUME ADJUSTMENT (CONTINUED)

Step 5 - Press the SOUND and WARNINGS button.

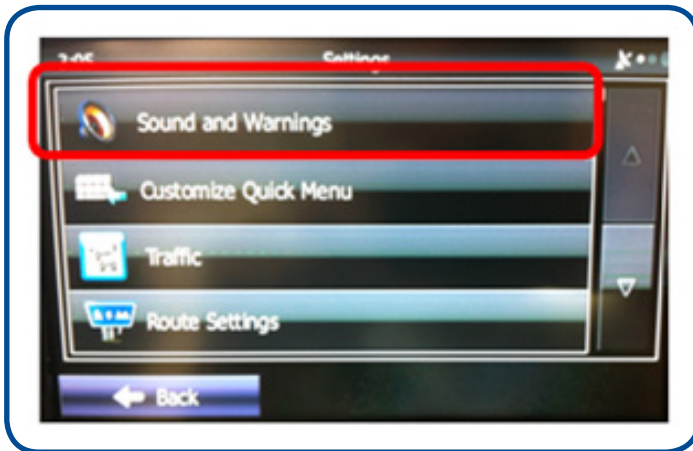

Step 6 - Press the VOLUME button.

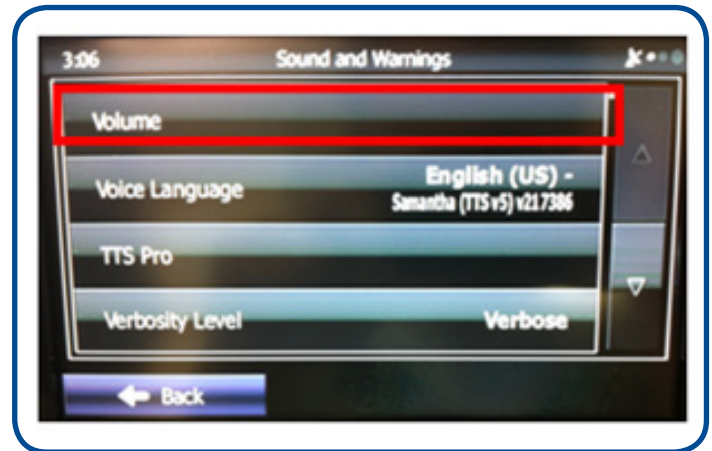

Step 7 - Press then move the cursor left then right to the desired volume setting.



Step 8 - After selecting the desired setting, push the MAP button again to complete the procedure.



18 WVX-34 REMINDER

As with any campaign, it is critical that all outlined procedures be followed exactly as written. In the case of WVX-34 Front Lower Control Arm (Transverse Link) Corrosion, a step that should never be skipped is the punch testing of the upper side of the control arms. Never assume that just because the bottom of the control arm (s) passed the punch test that the upper portion does not require testing (IT DOES.). Failure to test this area may result in not finding a weakness in this spot and lead to a failure of the control arm. If testing of this area has been neglected in the past, those vehicles need to return for additional inspection. Don't put yourself, your dealership, your customer, or other drivers on the roadways at risk. Always follow all procedures in every campaign (or service bulletin) completely.

15 WHEEL LOCKS

Investigations performed by the vendor in to Subaru Wheel Locks B321SFG000 have found that improper application resulted in the failure. Wheel locks are not to be used on steel wheels or spare wheels. The following information should be followed whenever wheel locks are installed.

- Remove one lug nut from each wheel. If the studs are dirty, clean them with a wire brush prior to wheel lock installation
- By hand, install one lock on each wheel
- Using the special key supplied in the wheel lock set and a torque wrench, tighten the wheel lock to the proper specification listed in the Service Manual for the vehicle you are working on
- Retain the lug nuts that were removed in the lock package for use on the spare wheel if necessary



Notes and Cautions

For ease of installation and removal, the wheel lock should always be the last lug nut tightened on each wheel and should always be the first one removed.

Use of an impact wrench may result in permanent damage to the wheel lock and key.

Use of wheel locks are for alloy wheels only. Use of wheel locks on steel wheels or temporary spare wheels may result in the condition as shown.

12 WINDSHIELD CRACKS ON THE INSIDE, A REMINDER

The Techline is beginning to see Authorization Requests submitted for windshield replacement where the glass is cracked on the inside of the vehicle. When cracked on the inside, it is often indicative of the wiper blade being dropped or allowed to slap back down onto the glass after clearing snow and ice or replacing a wiper blade / insert. This can easily be duplicated using a windshield that is already in need of replacement with damage in another area of the glass. The energy from the tip of the blade is transmitted into the glass through the outer layer of glass then the vinyl in the center and cracks the inside glass layer. These cracks will usually be found in the vicinity of where the wiper blade rests on the windshield. These types of failures are not stress cracks as often reported and not a matter for Warranty. The photo shows an example of this type of damage.



11-125-12; Technical Service Bulletin, DTCs P0365, P0366, P0390 and P0391. Misfire DTCs P0301, P0302, P0303 and P0304.

E551SSG200; Accessory Installation Guide, 2014 Forester Front Bumper Under Guards

SAJ; Troubleshooting Guide, Remote Engine Start Systems (2010-2013MY Legacy and Outback)

16-86-12; Technical Service Bulletin, Reprogramming for Illumination of AT Oil Temperature Warning Lamp

16-80-11R; Technical Service Bulletin, Oil Temperature Warning Lamp Flashing (Legacy, Outback & Tribeca) (revised)

H7110SG100; Accessory Installation Guide, 2014 Forester AC Power Outlet

2013 Calendar of Subaru Holidays

President's Day

Monday, February 18, 2013

Memorial Day

Monday, May 27, 2013

Independence Day

Thursday, July 4, 2013

Labor Day

Monday, September 3, 2013

Thanksgiving Day

Thursday, November 28, 2013

*** NOW YOU CAN E-MAIL YOUR TECHTIPS INPUT AND SUGGESTIONS TO: SERVICEINFO@SUBARU.COM ***

This is your chance to offer suggestions for use in future issues of TechTIPS! Make sure that if you e-mail us, you place in the **subject line** of your e-mail "**For TechTIPS Newsletter**". Thank you!

MODEL: _____

YEAR: _____

VIN: _____

Description of situation encountered: _____

Your suggestion for repair procedure, product improvements, etc.:

Please attach separate sheets, if necessary. You may also want to include Service Manual diagrams or references, or your own drawings to assist in describing your suggestion. All information submitted becomes the property of Subaru of America, Inc. Permission is granted to Subaru of America, Inc. to print your name and suggestions in TechTIPS and other Subaru of America, Inc. publications. Mail items to: PO Box 6000, Cherry Hill, NJ 08034-6000.

Your Name: _____ **Signature:** _____

Dealer's Name: _____ **City:** _____

Date: _____ **Dealer Code:** _____

SUBARU TECHLINE
Hours of Operation

Monday – Thursday 8:30am to 6:30pm
Friday 10:30am to 5pm