



# Technical Service Bulletin

SUBJECT:		No: <b>TSB-16-00-012</b>	
<b>NEW MODEL FEATURES &amp; SERVICE INFORMATION – 2017 OUTLANDER</b>		DATE: <b>September, 2016</b>	
		MODEL: <b>2017 Outlander</b>	
CIRCULATE TO:	<input type="checkbox"/> GENERAL MANAGER	<input checked="" type="checkbox"/> PARTS MANAGER	<input checked="" type="checkbox"/> TECHNICIAN
<input checked="" type="checkbox"/> SERVICE ADVISOR	<input checked="" type="checkbox"/> SERVICE MANAGER	<input checked="" type="checkbox"/> WARRANTY PROCESSOR	<input checked="" type="checkbox"/> SALES MANAGER

## PURPOSE



This bulletin contains important new model service information and features for the **2017 Outlander** (U.S. models only). Review the details that follow to familiarize yourself regarding new features and options. Refer to the 2017 Outlander Service Manual on MEDIC, MDL, or CD (p/n MSCD-007B-2017), and the Owner's Manual for details on these and other features.

## AFFECTED VEHICLES

2017 Outlander

### U.S. MODEL LINEUP

MODEL	ENGINE	TRANSMISSION
ES (2WD / AWC)	4J12 – 2.4L SOHC MIVEC 16V 4 cyl.	CVT
SE (2WD / S-AWC)		
SEL (2WD / S-AWC)		
GT (S-AWC)	6B31 – 3.0L SOHC MIVEC 24V 6 cyl.	6 spd. A/T w/shift paddles

## SERVICE INFORMATION

See TSB-16-00-011 for 2017 Outlander Technical Specifications.

## NEW FEATURE HIGHLIGHTS

### EXTERIOR

- Shark-fin antenna
- LED fog lamps
- Electric folding side mirrors
- Chrome beltline molding and silver roof rails
- Sunroof

### COMMENTS

- Standard on all 2017 Outlander
- Standard on GT
- Standard on SEL
- Standard on SEL
- New option for SE (with fabric seats)

**DRIVETRAIN**

New All-Wheel Control (AWC) system

**COMMENTS**

Now available on ES

**INTERIOR**

Redesigned center floor console with console box lamp, cargo 12-volt power outlet, front courtesy floor lamps, knit-fabric sun visors, low washer fluid warning lamp

**COMMENTS**

Standard on all 2017 Outlander

High contrast meter, Display Audio with rear camera, dual zone A/C

Standard on all ES

**ELECTRICAL**

LED position lamps automatically turn on with release of emergency parking brake while vehicle is on

**COMMENTS**

Standard on all 2017 Outlander

Windshield wiper de-icer

Standard on 4WD models

Electric Parking Brake switch

Standard on S-AWC models

Heated steering wheel

Available on SEL/GT Touring package

**TECHNOLOGY**

Blind Spot Warning (BSW) with Lane Change Assist (LCA) and Rear Cross Traffic Alert (RCTA)

**COMMENTS**

Option for SEL, standard on GT

Smartphone link Display Audio with enhanced SiriusXM® radio, Apple CarPlay™, Android Auto™, and dual USB ports

Standard on SE, SEL, GT

Display audio with rear camera, dual air conditioning

Standard on ES

Auto-dimming mirror with Homelink®, Auto On/Off Headlights, rain sensing wipers

Standard on SEL, GT

Automatic High Beam (AHB) headlights

Available on SEL/GT Touring package

Multi-view camera

Available on SEL/GT Touring package

Forward Collision Mitigation (FCM) with Pedestrian Detection

Available on SEL/GT Touring package

## EXTERIOR



- New shark fin antenna is now standard on all 2017 Outlander models.



- LED fog lamps are standard on GT models.

## DRIVETRAIN

- A new All-Wheel Control (AWC) system is now available on ES models.

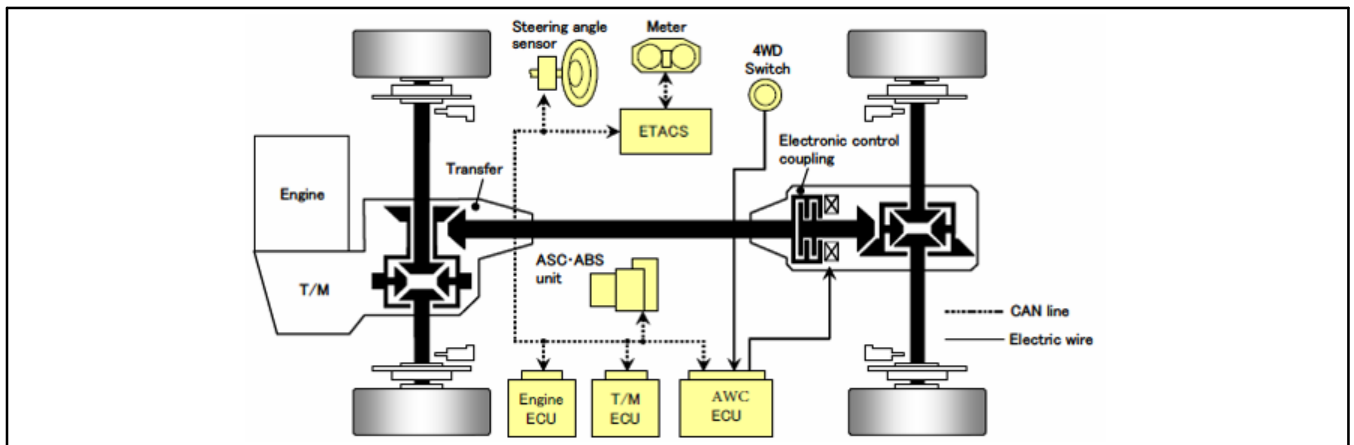

## INTERIOR



Now standard on all 2017 Outlander models:

- Redesigned center floor console with console box lamp
- Cargo area 12-volt power outlet
- Front courtesy floor lamps
- Knit-fabric sun visors
- Low washer fluid warning lamp



## ELECTRICAL



- Heated steering wheel is available on SEL and GT Touring package. The steering wheel heater automatically stops after 30 minutes to prevent 12V battery power outage.

## TECHNOLOGY



- Smartphone Link Display Audio is now standard on SE, SEL, and GT models.



- a. Now with enhanced features for SiriusXM Satellite Radio including Artist/Song Alert, Game Alert, Sports Flash, Smart Favorites, Tune Mix, Tune Scan, Tune Start, and Parental Lock.
- b. Also supports Apple CarPlay® and Android Auto™.



- Display Audio, rear camera, and dual climate control are now standard on ES models.

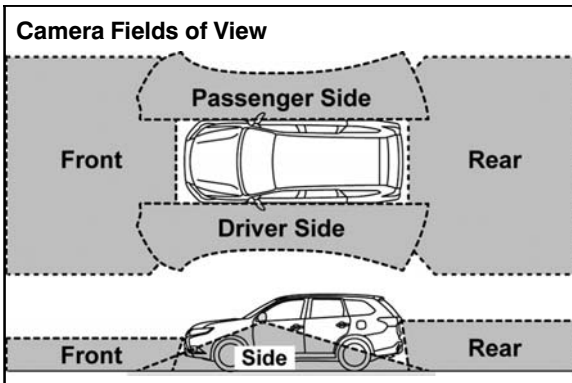
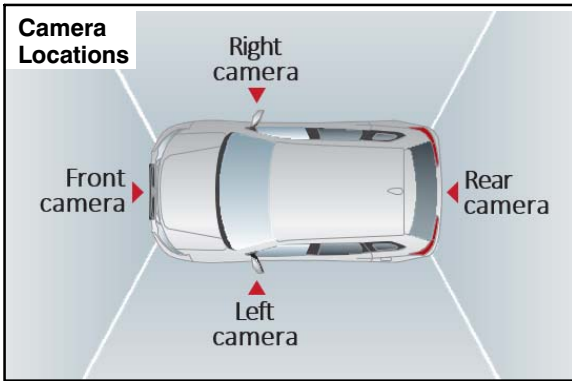

- Multi-View Camera is available on SEL and GT models.
  - This monitor displays front, rear, and side views so the driver can see objects in blind spots.
- Includes a “Bird’s-eye view” function that provides support during parking.

Front view and Rear view display

Bird's Eye View and Side View Display

Check surroundings for safety.

Check surroundings for safety.

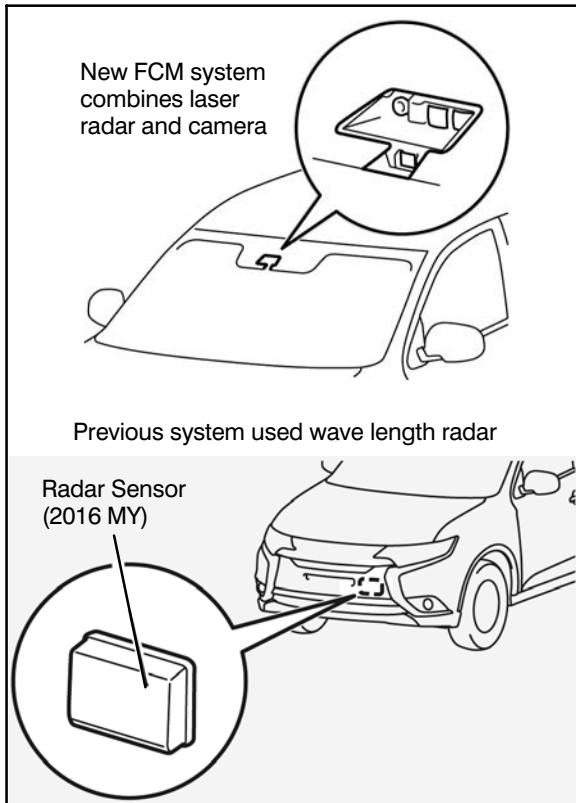

- Forward Collision Mitigation (FCM) performance has been improved by using both laser radar and camera systems. Available on SEL and GT Touring package.
  - New location: Now mounted in upper windshield area.
  - MMCS Navigation system has been discontinued.

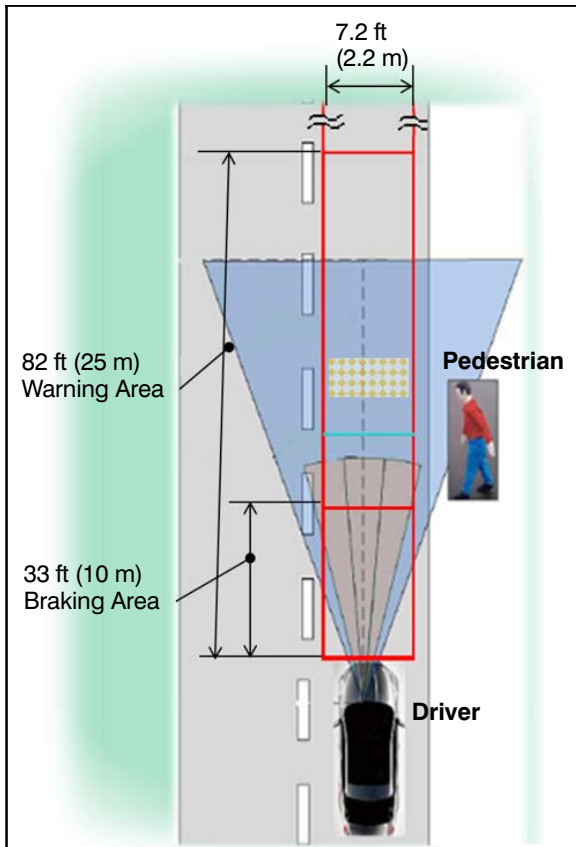

- New pedestrian detection capability has been added to the Forward Collision Mitigation (FCM) system.



- New Automatic High Beam headlights are now available on SEL and GT Touring package. The high beam automatically adjusts to low beam when other vehicles are nearby (oncoming and preceding).

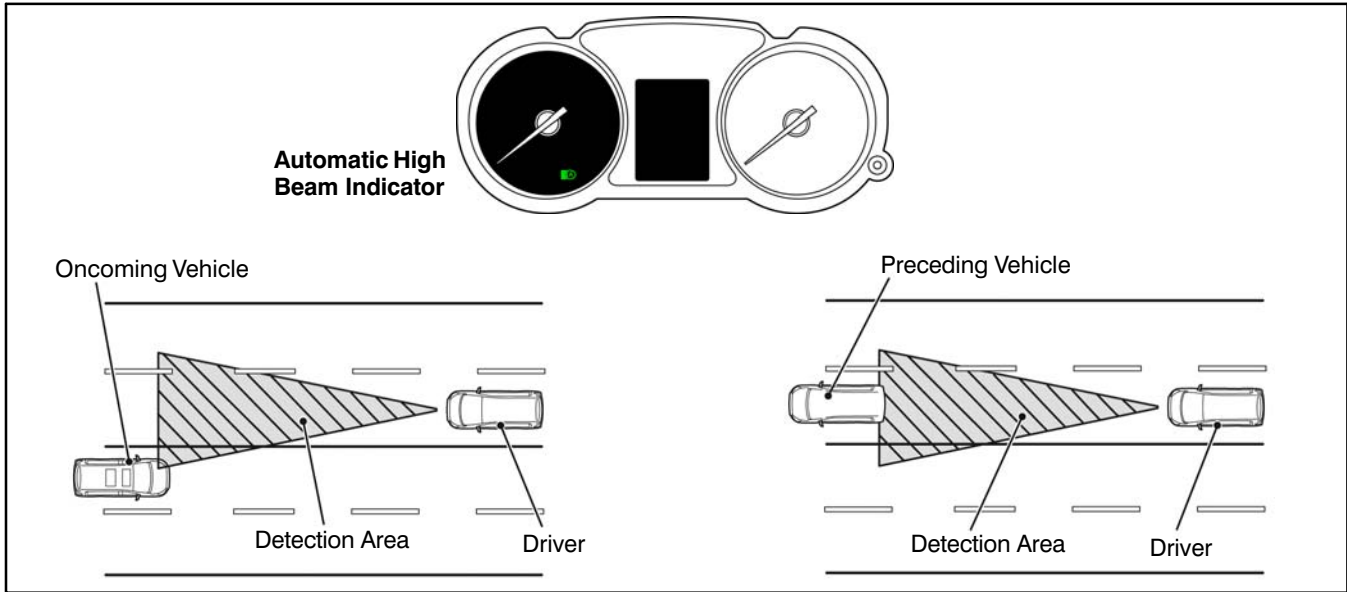

- Blind Spot Warning (BSW) with Lane Change Assist (LCA) and Rear Cross Traffic Alert (RCTA) are now standard on GT, Option on SEL.



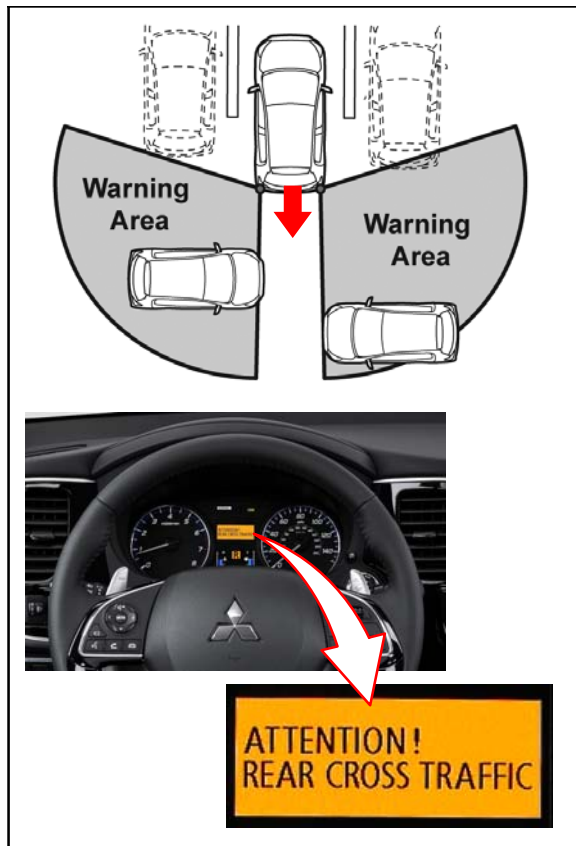

- Rear Cross Traffic Alert (RCTA) system warns the driver of cross traffic in the multi-information display.

## FACTORY AND PORT OPTION PACKAGES

### SE SUNROOF PACKAGE – 2017 Outlander SE

- Power glass sunroof with tilt & slide and one touch open/close switch

### SEL PREMIUM PACKAGE – 2017 Outlander SEL

- 710-Watt, 9 speaker Rockford-Fosgate® Premium Audio System including 10-inch dual-voice coil subwoofer w/Punch control®, DTS® Neural Surround, PremiDIA-WIDE® surround and Dolby® Volume
- Blind Spot Warning (BSW) with Lane Change Assist (LCA) and Rear Cross Traffic Alert (RCTA)
- Power glass sunroof with tilt & slide and one touch open/close switch
- Power remote operated liftgate

**SEL TOURING PACKAGE – 2017 Outlander SEL**

- Multi-view camera system
- Adaptive Cruise Control (ACC) system
- Forward Collision Mitigation (FCM) System
- Lane Departure Warning (LDW) system
- Automatic High Beams
- LED headlights
- Heated steering wheel
- Blind Spot Warning (BSW) with Lane Change Assist (LCA) and Rear Cross Traffic Alert (RCTA)
- 710-Watt, 9 speaker Rockford-Fosgate® Premium Audio System including 10-inch dual-voice coil subwoofer w/Punch control®, DTS® Neural Surround, PremiDIA-WIDE® surround and Dolby® Volume
- Power glass sunroof with tilt & slide and one touch open/close switch
- Power remote operated liftgate

**GT TOURING PACKAGE – 2017 Outlander GT**

- Multi-view camera system
- Adaptive Cruise Control (ACC) system
- Forward Collision Mitigation (FCM) System
- Lane Departure Warning (LDW) system
- Automatic High Beams
- Heated steering wheel

**ALL WEATHER PACKAGE – 2017 Outlander – All Trim Levels**

- Remote engine start
- All-weather floor mats (4)

**CARGO MAT PACKAGE – 2017 Outlander – All Trim Levels**

- Cargo mat
- Cargo net
- 3<sup>rd</sup> row floormats

**INTERIOR PACKAGE – 2017 Outlander – All Trim Levels**

- Aluminum/leather shift knob
- Piano black accent panels and door switch panels

**EXTERIOR PACKAGE – 2017 Outlander – All Trim Levels**

- Large rear spoiler
- Alloy fuel door
- Front, side, and rear airdams

**PROTECTION PACKAGE – 2017 Outlander – All Trim Levels**

- Scuff plates
- Rear bumper step protector
- Body side moldings
- Tailgate protector

**LED ILLUMINATION PACKAGE** – 2017 Outlander – All Trim Levels

- Floor illumination (Blue LED)
- Interior lights
- Tailgate illumination (Blue LED)

**BLUE LED ILLUMINATION PACKAGE** – 2017 Outlander – All Trim Levels

- Floor illumination
- Tailgate illumination

**CARGO TRAY PACKAGE** – 2017 Outlander – All Trim Levels

- Cargo tray
- 3<sup>rd</sup> row floormats
- Cargo net

**ENTERTAINMENT PACKAGE** – 2017 Outlander – All Trim Levels

- Rear seat DVD player
- Remote control
- Infrared wireless headphones (2)

**TOWING PACKAGE** – 2017 Outlander – All Trim Levels

- Tow hitch
- Trailer tow wire harness

**WIND DEFLECTOR PACKAGE** – 2017 Outlander – All Trim Levels

- Side wind deflectors
- Hood protector

**PARK ASSIST SENSOR PACKAGE** – 2017 Outlander SE, SEL, GT

- Front and rear park assist sensors

**CHROME PACKAGE** – 2017 Outlander SE, SEL, GT

- Door handle covers
- Side view mirror covers

### ACCESSORY OPTIONS (U.S. Models)

The following port and/or dealer installed accessories are available for 2017 Outlander.

- Halogen fog lights (ES only)
- LED fog lights (SE, SEL, GT only)
- Piano black accent panels (ES & SE only)
- Hood protector
- Sunroof wind deflector (SEL & GT only)
- Roof rack crossbars
- Tonneau cover
- Front and rear mudguards
- All weather floor mats (4)
- Third row floormat
- Color keyed body side moldings
- Rear park assist sensors
- Wheel locks
- Alloy fuel door

<b>WARRANTY</b>	
<b>NOTE: SEE WB 2017-002 FOR 2017 MY WARRANTY HIGHLIGHTS</b>	
<b>U.S. and Puerto Rico</b>	<b>Canada</b>
● Basic – 5 years or 60,000 miles	● Basic – 5 years or 100,000 km
● Powertrain – 10 years or 100,000 miles (original retail purchaser only). 5 years or 60,000 miles to subsequent owners.	● Powertrain – 10 years or 160,000 km
● Outer Panel Rust Perforation – 7 years or 100,000 miles	● Rust Perforation – 5 years with unlimited km
● Adjustments – 1 year or 12,000 miles	● Adjustments – 1 year or 20,000 km
● Roadside Assistance – 5 years / unlimited miles	● Roadside Assistance – 5 years/unlimited km
● Emissions – Refer to the Warranty and Maintenance Manual for coverage details.	