



SERVICE BULLETIN

Classification: AT15-005h	Reference: NTB15-015h	Date: April 27, 2017
------------------------------	--------------------------	-------------------------

PATHFINDER, QUEST, MURANO, MAXIMA, ALTIMA V6; CVT JUDDER AND DTC P17F0 OR P17F1 STORED

This bulletin has been amended to remove 2013-2014 Pathfinder from applied vehicles. No other changes have been made. Please discard all previous versions of this bulletin.

APPLIED VEHICLES: 2015-2017 Pathfinder (R52) **with V6 engine only**
2013-2017 Altima Sedan (L33) **with V6 engine only**
2015-2017 Quest (E52)
2015-2017 Murano (Z52)
2016-2017 Maxima (A36)

APPLIED TRANSMISSION: CVT

IF YOU CONFIRM:

The customer reports a transmission judder (shake, shudder, single or multiple bumps or vibration)

AND

One of these DTCs is stored.

- **P17F0** (CVT_JUDDER (T/M INSPECTION))
- **P17F1** (CVT_JUDDER (C/U INSPECTION))

NOTE:

- If a transmission judder (as described above) is not reported, this bulletin does not apply.
- If either **P17F0** or **P17F1** are not stored, this bulletin does not apply.

Nissan Bulletins are intended for use by qualified technicians, not 'do-it-yourselfers'. Qualified technicians are properly trained individuals who have the equipment, tools, safety instruction, and know-how to do a job properly and safely. **NOTE:** If you believe that a described condition may apply to a particular vehicle, DO NOT assume that it does. See your Nissan dealer to determine if this applies to your vehicle.

ACTIONS:

Perform the **SERVICE PROCEDURE**, starting on page 3.

- Review the **Repair Flow Chart** on this page.

NOTE: Essential Tool Tech Cam (borescope) J-51951 has been sent to dealers. This tool's attachments make CVT inspection possible.

=====

Repair Flow Chart

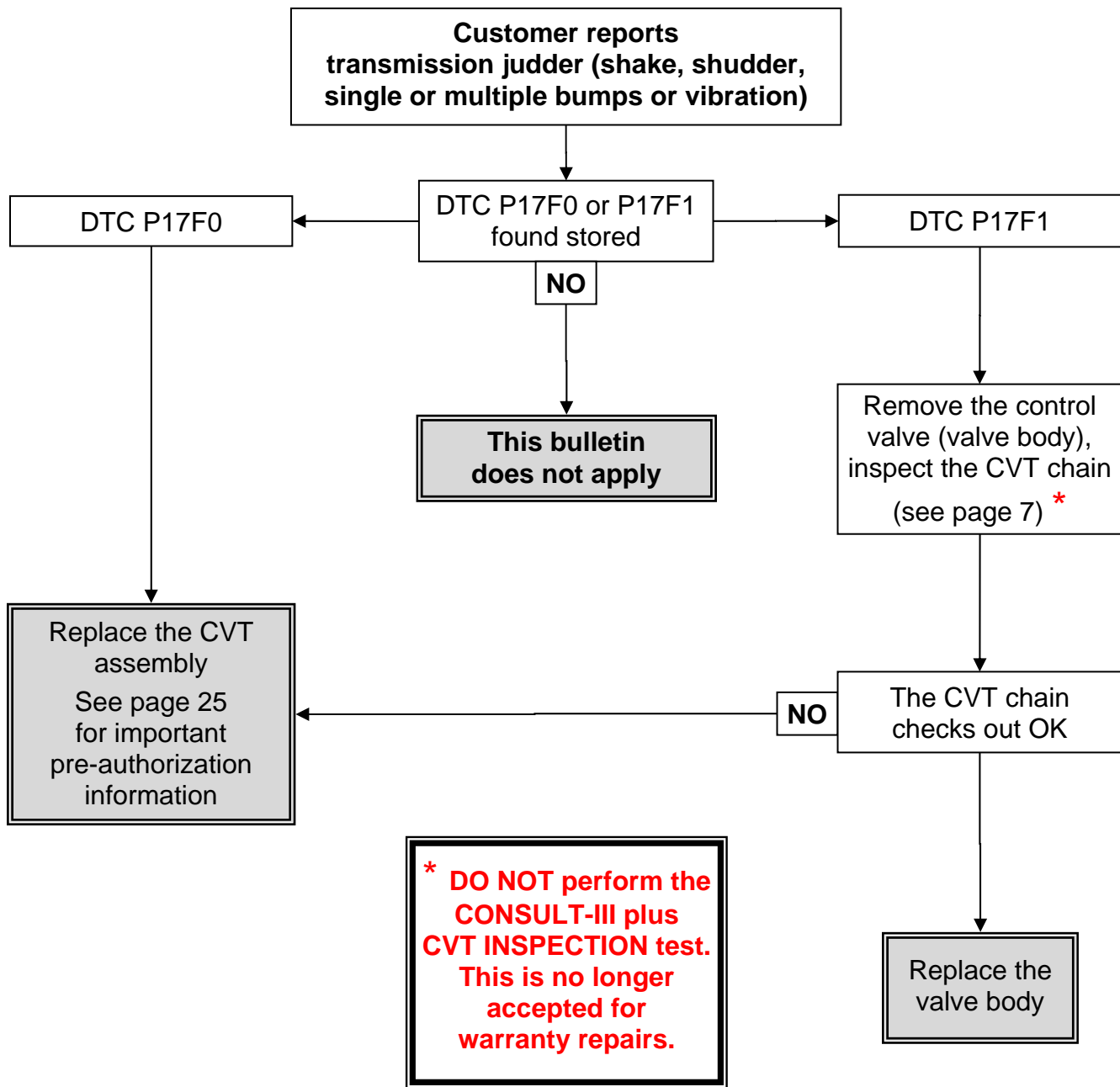

SERVICE PROCEDURE

Check for Stored DTCs

1. Before starting, it is **IMPORTANT** to make sure:
 - ASIST on the CONSULT PC has been freshly synchronized (updated).
 - All CONSULT related software updates (if any) have been installed.
2. Once all ASIST and CONSULT related updates have been performed, attach the CONSULT PC to the vehicle.
 - Connect the plus VI to the vehicle.
 - Connect the AC adapter to the CONSULT PC.
3. Turn ON the CONSULT PC, and then open CONSULT III plus (C-III plus).
NOTE: Make sure all applications other than C-III plus are closed.
4. Press the ignition switch twice without depressing the brake pedal.
 - The meter and gauges will illuminate.
 - Do Not start the engine.
 - Make sure ALL accessories are turned OFF.
5. Wait for the plus VI to be recognized.
 - The serial number will display when the plus VI is recognized.
6. Go to **Diagnosis (All Systems)**.

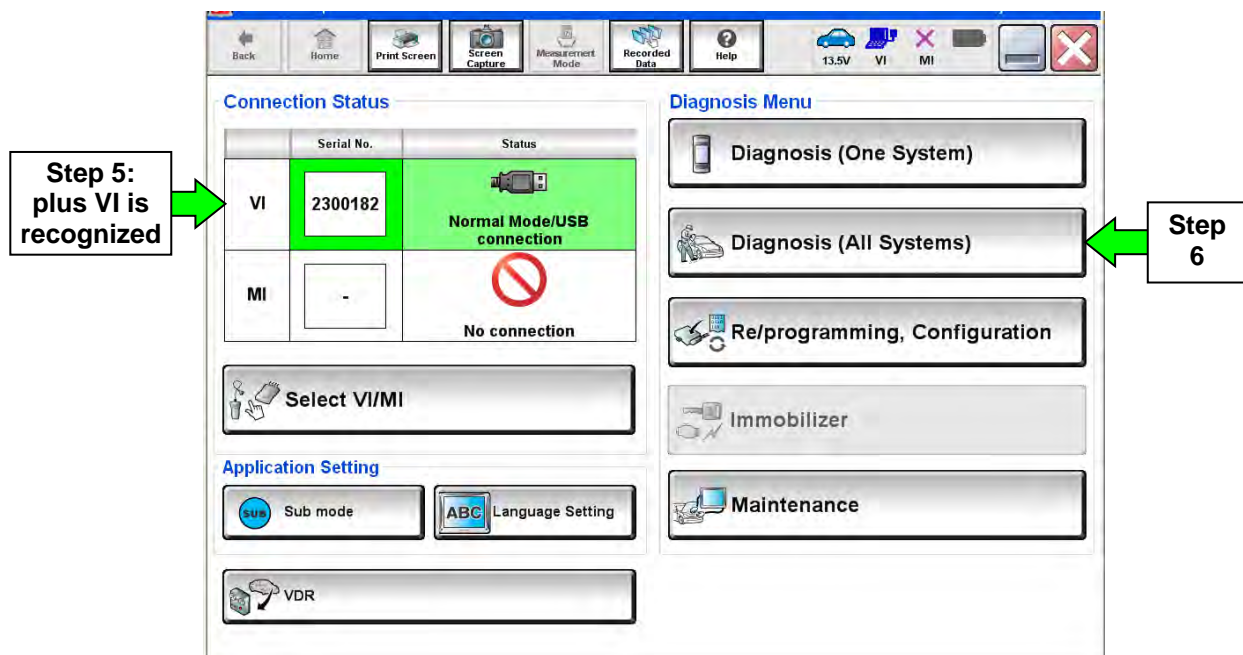

Figure 1

7. Select **TRANSMISSION**.

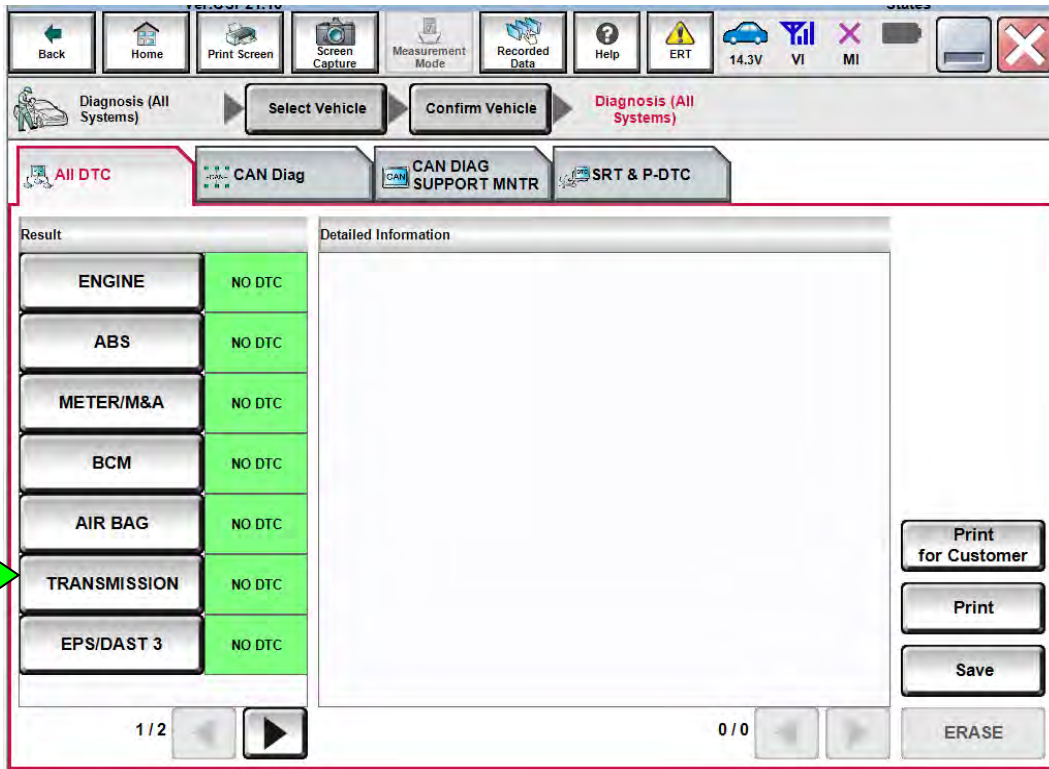

Figure 2

8. Select the **Self Diagnostic Result** tab, print the screen showing the VIN and DTC, and then attach the printout to the repair order.

IMPORTANT: The screen printout MUST clearly show the VIN and DTC.

- a. If P17F0 is stored, replace the CVT assembly.
 - For CVT assembly pre-approval, refer to page 25, **CVT Assembly Replacement Approval Procedures**.
 - Refer to the appropriate Electronic Service Manual (ESM), section **TM-Transaxle & Transmission**, for CVT assembly replacement procedure.
 - Skip to step 9.
- b. If P17F1 is stored, go to page 7, **Control Valve (Valve Body) Removal and CVT Chain Inspection – for DTC P17F1 ONLY** after completing steps 9-12.
- c. If neither P17F0 nor P17F1 are found stored, this bulletin does not apply. Close C-III plus, and then refer to ASIST and the ESM for further diagnosis.

9. Select **ERASE**.

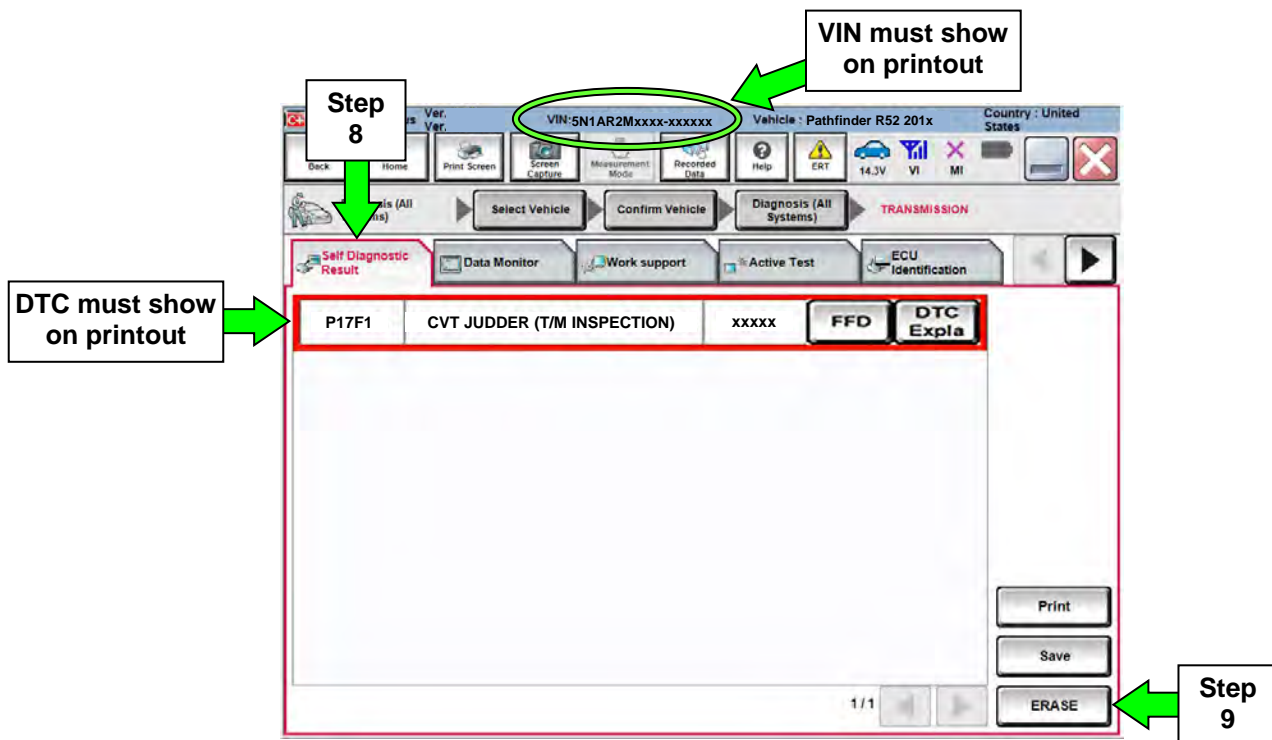

Figure 3

10. Close C-III plus.
11. Turn the ignition OFF.
12. Disconnect the plus VI from the vehicle.

For vehicles with P17F1, go to page 7, **Control Valve (Valve Body) Removal and CVT Chain Inspection – for DTC P17F1 ONLY** after completing steps 9-12.

Example: Exploded View of Control Valve (valve body)

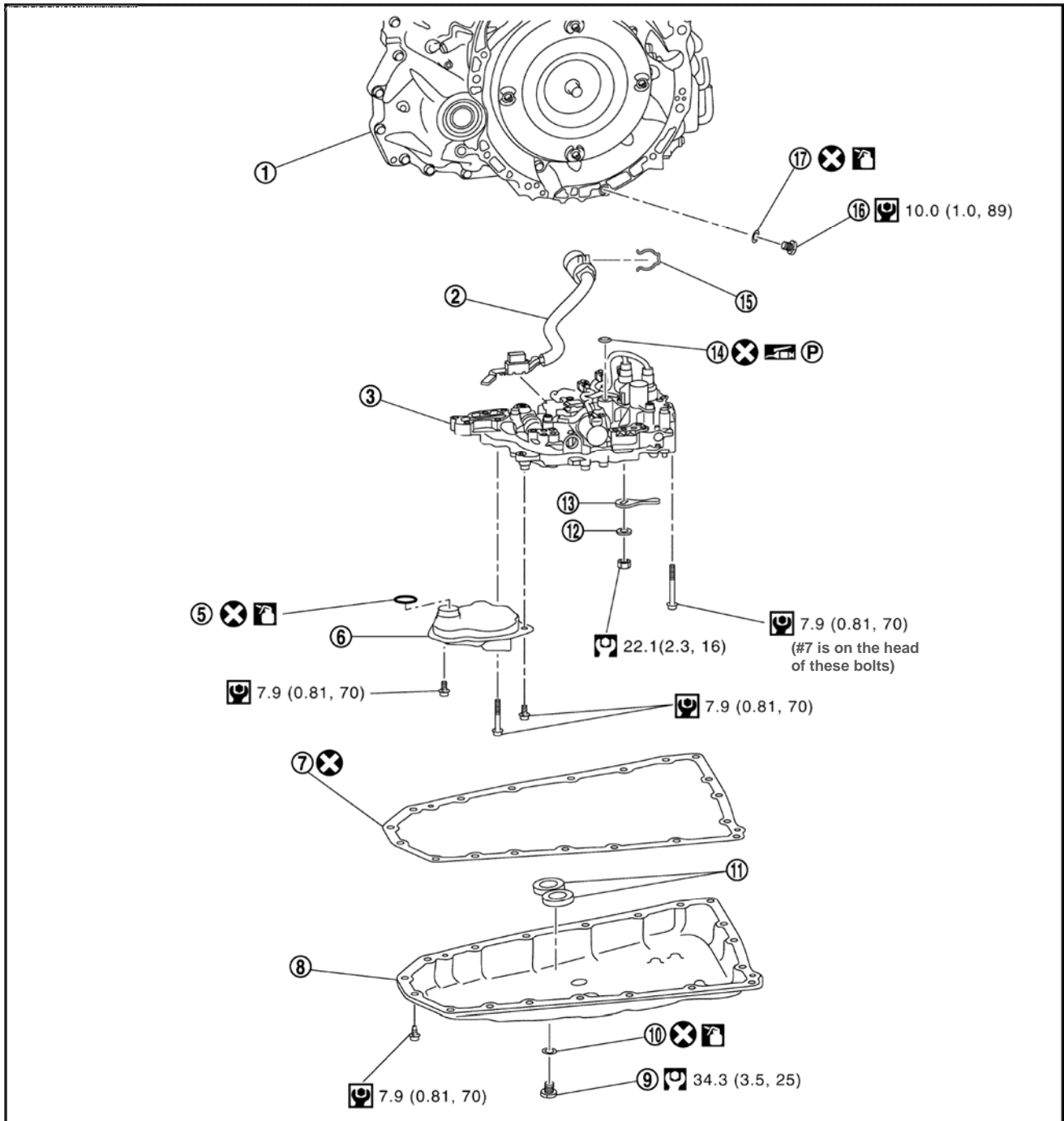

Figure 4

- | | | | | | |
|---|--------------------------|---|------------------------|---|----------------------------|
| ① | Transaxle (CVT) assembly | ② | Terminal cord assembly | ③ | Control valve (valve body) |
| ⑤ | O-ring | ⑥ | Oil strainer assembly | ⑦ | Oil pan gasket |
| ⑧ | Oil pan | ⑨ | Drain plug | ⑩ | Drain plug gasket |
| ⑪ | Two magnets | ⑫ | Spring washer | ⑬ | Manual plate |
| ⑭ | Lip seal | ⑮ | Snap ring | ⑯ | Overflow plug |
| ⑰ | O-ring | | | | |

⊗ : Always replace after every disassembly.

⊞ : N·m (kg-m, ft-lb)

⊞ : N·m (kg-m, in-lb)

Control Valve (Valve Body) Removal and CVT Chain Inspection –for DTC P17F1 ONLY

1. Remove the valve body.

- Before lifting the vehicle:
 - Place the transmission gear selector in Neutral.
 - Leave the driver door unlatched. A step further in the procedure may require it.

NOTE:

- The number '7' is on the head of all bolts that need to be removed for valve body removal. Do not remove any bolt that does not have the number '7'.
- Due to multiple model vehicles, pictures throughout the service procedure are examples and may not exactly match your vehicle.

CAUTION: Never allow any chemicals or fluids other than NS-3 CVT fluid or equivalent to enter the CVT assembly. Never allow any foreign debris, dust, dirt, etc. to enter the CVT assembly.

NOTE: For additional information, see video # 546: "CVT Chain Inspection". This video is located under the TECH TRAINING GARAGE VIDEOS tab in Virtual Academy.

2. Secure the right front tire with a suitable strap.
 - This will assist in making the chain turn.
3. Mark the left front tire with a suitable marking.
 - This will assure all 360° of the chain is inspected.



Figure 5

4. Using borescope J-51951 with mirror attachment, visually inspect the side of the chain that comes in contact with the pulley:
 - a. First inspect the entirety (360°) of the driver side of the chain that comes in contact with the pulley (see page 10, Figure 9 and 10, and page 12, Figure 13).
 - b. If the inspection result is OK on all 360°, inspect all 360° of the passenger side of the chain.

NOTE: Reference the pictures on page 13-15 for comparison.

- Insert the camera lens behind the pulley between the guide rail and the pulley where shown in Figure 6 (also see page 9-10, Figure 7-10).
- Insert the lens approximately 8-9 inches, and then view the side of the chain that contacts the pulley.

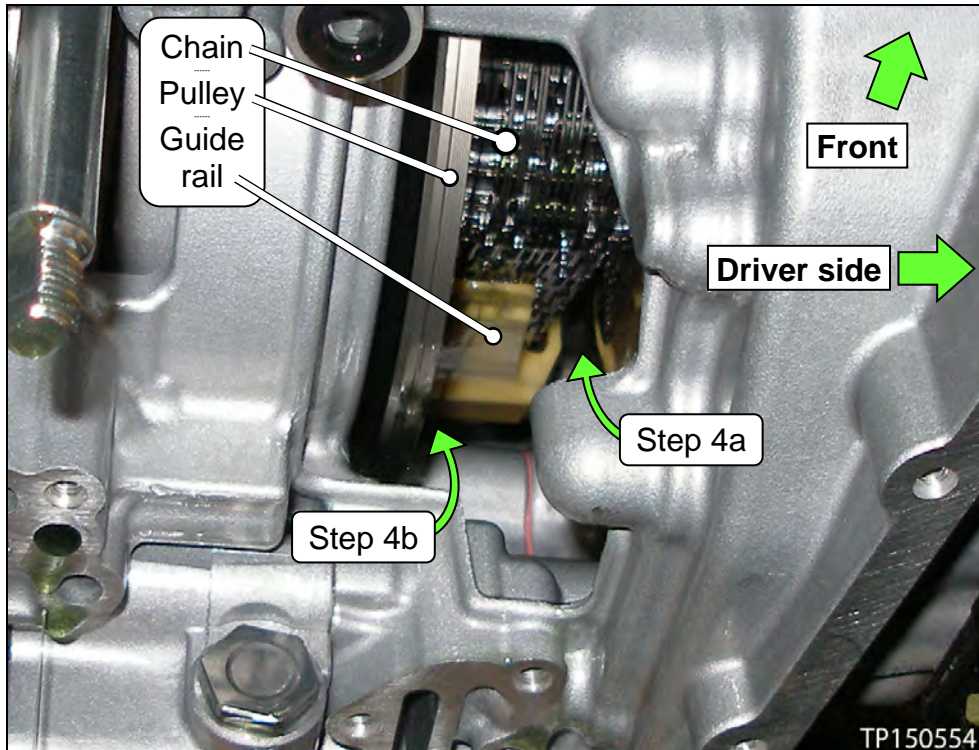

Figure 6

- Figure 8 shows where to insert the camera lens on the driver side of the chain.

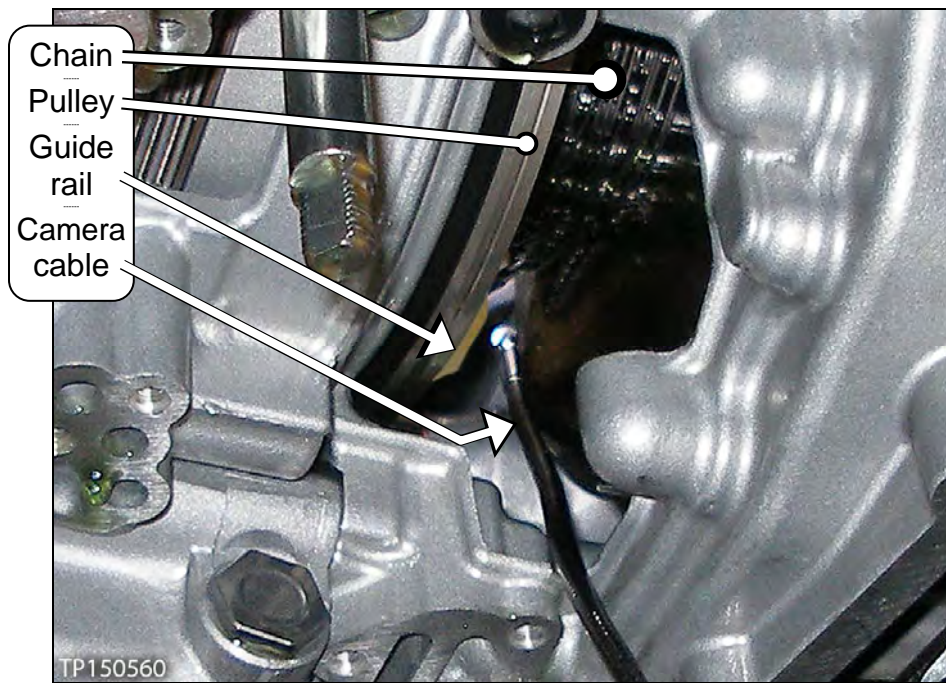

Figure 7

- Figure 9 shows where to insert the camera lens on the passenger side of the chain.

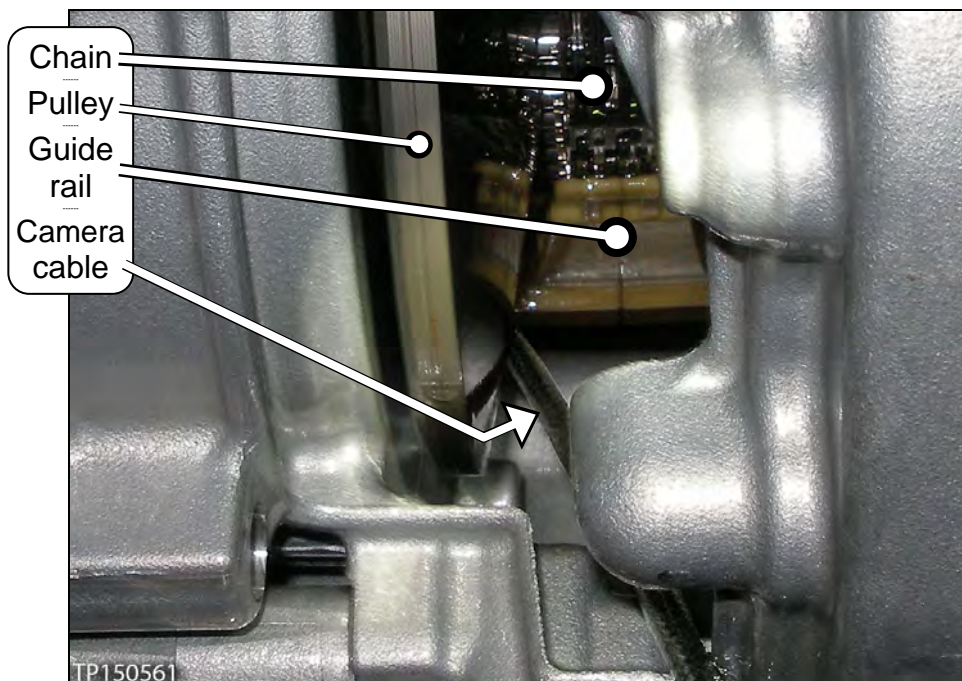

Figure 8

- Figures 9 and 10 shows the routing and location of the camera.

NOTE: The CVT's side cover was removed for easier viewing of camera location. The side cover is not to be removed at any time during this procedure.

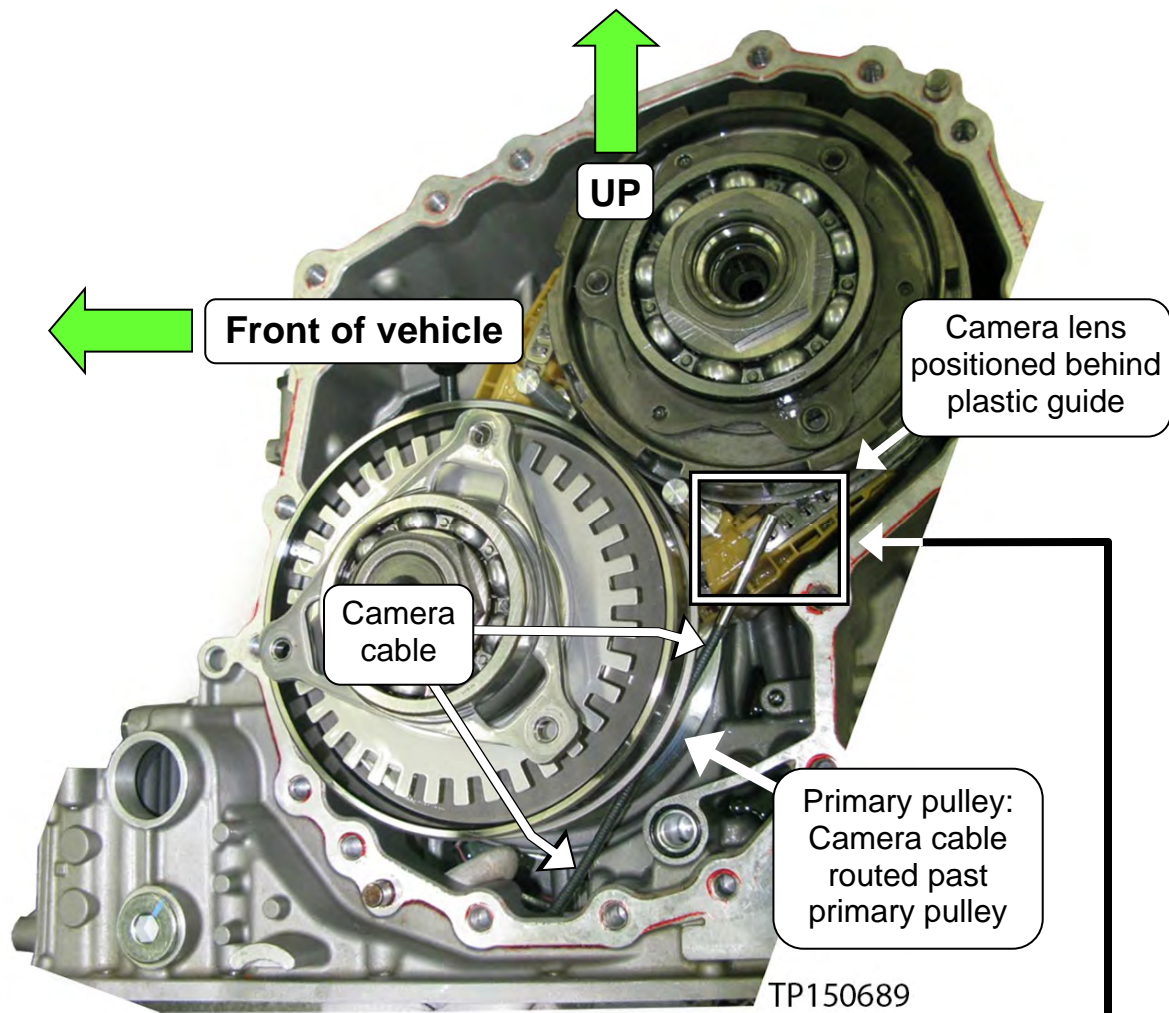

Figure 9

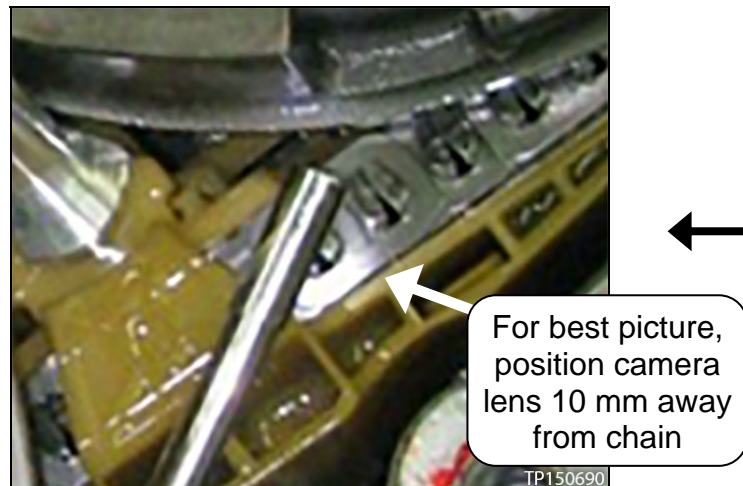

Figure 10

4c. Slowly and carefully turn the left front tire one full turn in the forward rotation to view all of the chain.

- Holding the borescope with one hand allows for turning the tire with the other hand (see Figure 11).

CAUTION: If the tire is rotated in the rearward rotation, the camera lens may get caught between the chain and pulley.

d. If the inspection result is OK on all 360° on both sides of the chain, skip to step 5 on the next page.

- If any evidence of chain slippage is found, go to step 4e, and then skip to step 6.
- Refer to Garage Video #564 if needed (see bottom of page 7).

e. Once CVT replacement is determined as required, use borescope J-51951 to record a 15 second or less continuous video of the most severe evidence of chain slip and the VIN on the F.M.V.S.S. certification label (VIN label). See example in Figure 12.

- For best picture, the camera lens should be about 10 mm away from the object being recorded.



Figure 11

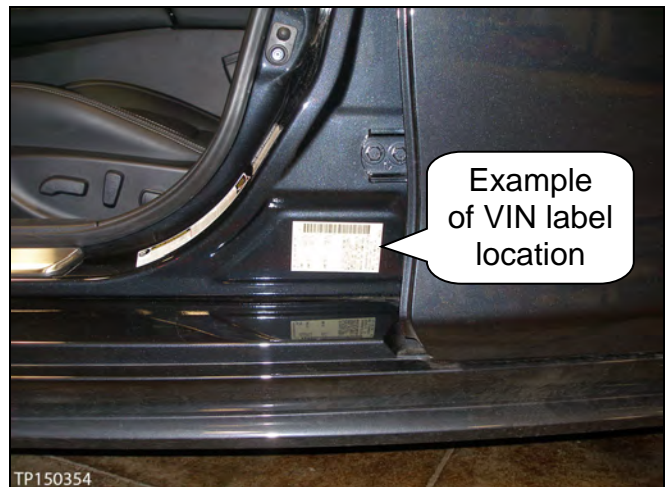

Figure 12

NOTE: This required video must be attached to the Powertrain Call Center CVT Preauthorization Form (in ASIST) prior to calling for authorization. Failure to submit a continuous video will cause immediate denial of request for replacement.

- Before starting to record, make sure the camera handle's AA batteries are fresh and the LCD monitor's battery is charged.
- The whole video will show as backward, or reversed mirror image. This is okay.
- The required video must show clear evidence of chain slippage and be 15 seconds or less.

5. Flush the CVT cooler(s).

IMPORTANT: A CVT Cooler flush is required after a valve body or CVT assembly replacement. Refer to bulletin NTB15-013 to perform CVT Cooler flush.

6. If the chain inspection result is OK, replace the valve body.

- There is no need for pictures or video showing “OK” chain surfaces.
- For valve body replacement, go to page 16, **Control Valve (Valve Body) Installation**.

7. If the chain inspection result is NG, replace the CVT assembly.

- Get authorization to replace the CVT assembly (see page 25).
- Make sure to perform step 4d on page 11.
- For CVT assembly replacement, refer to the appropriate ESM, section **TM – Transaxle & Transmission**.

IMPORTANT: Perform "ADDITIONAL SERVICE WHEN REPLACING TRANSAXLE ASSEMBLY".

➤ Refer to **TM – Transaxle & Transmission / BASIC INSPECTION:**

- Check for fluid leakage.
 - Install Write IP Characteristics to the TCM.
 - Perform Select Learning (Drive/Reverse Learning)
 - Erase CVT Fluid Degradation Level Data
- The CVT unit requiring replacement will need to be reassembled for Nissan parts return/collection.

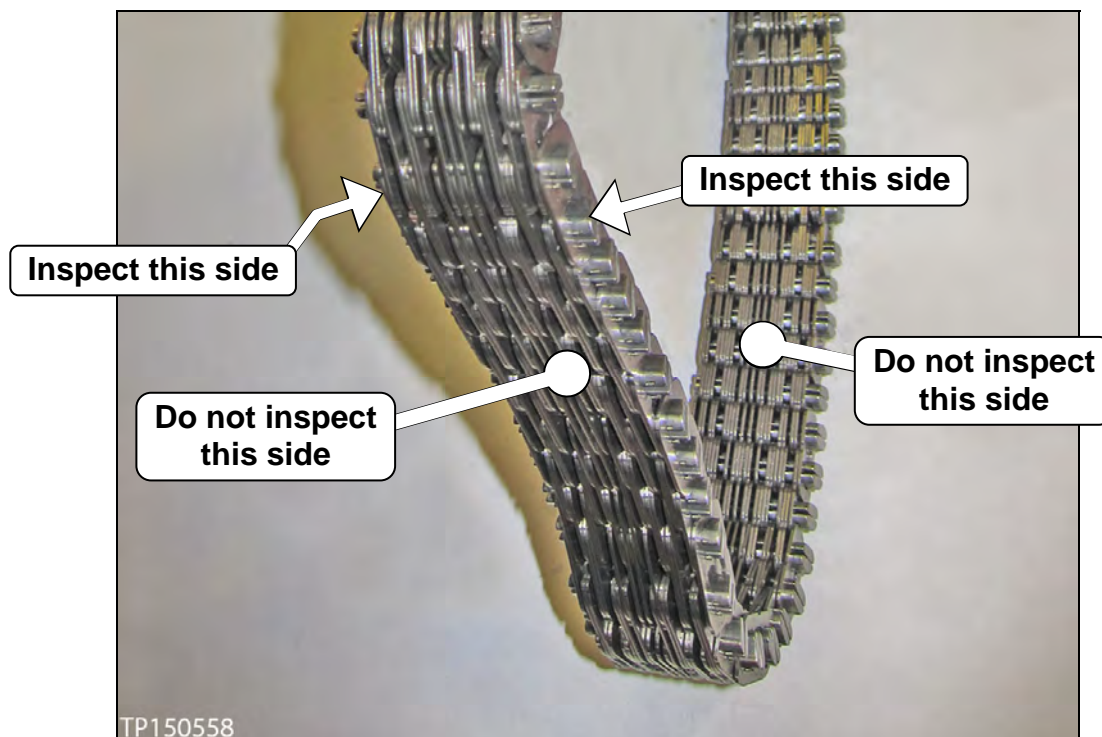
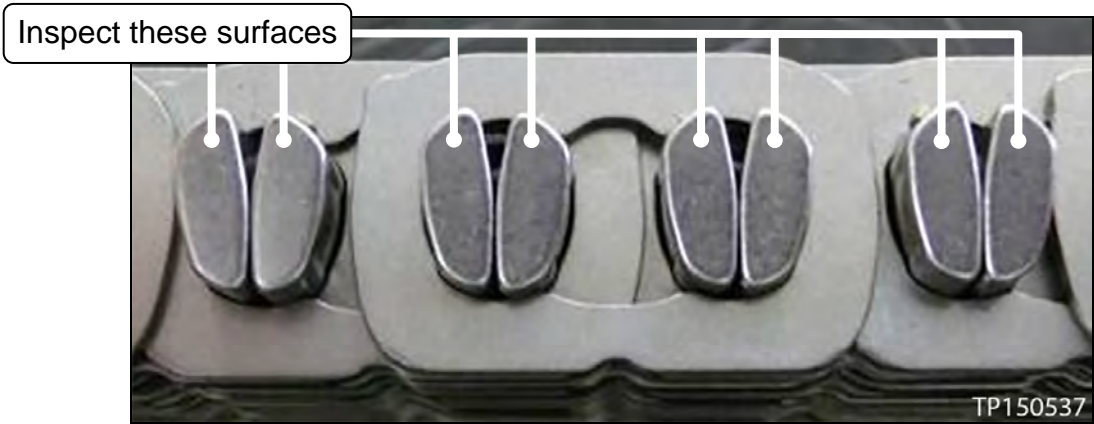

Figure 13



TP150559

Figure 14: CVT chain



TP150537

Figure 15: Close-up of area to be inspected

Pictures in Figure 16 and 17 were taken with borescope J-51951.



Figure 16

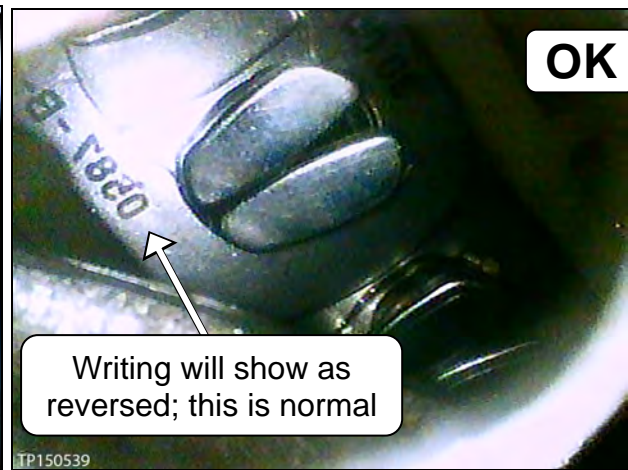

Figure 17



Figure 18



Figure 19

Pictures in Figure 20-21 were taken with borescope J-51951.

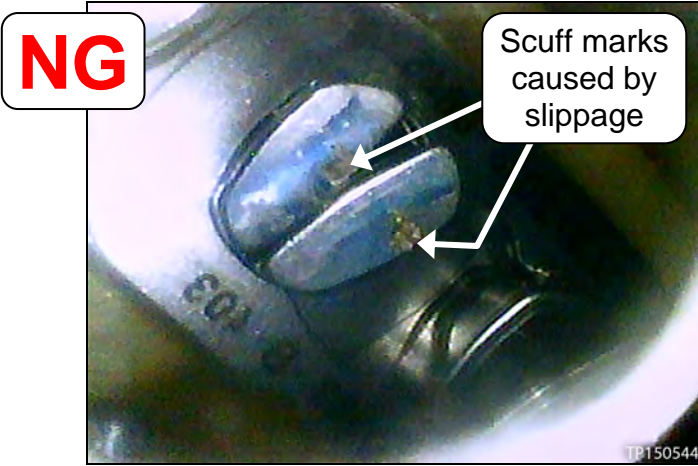

Figure 20



Figure 21



Figure 22



Figure 23



Figure 24

Control Valve (Valve Body) Strainer and Pan Installation

IMPORTANT: This section may contain different style parts than what were originally installed in the CVT. Pay careful attention, REASSEMBLY MAY NOT BE IDENTICAL TO DISASSEMBLY.

Confirm that the QR label, control valve and CD part numbers all match before installing the control valve.

CAUTION: Handle the valve body carefully.

1. Discard the oil strainer bracket (Figure 25).

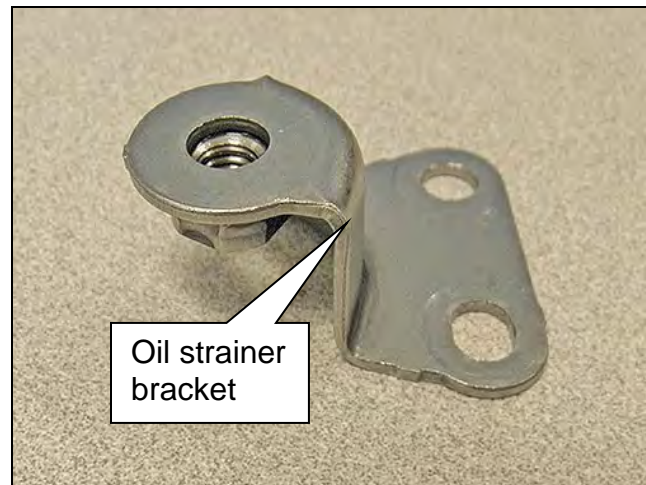

Figure 25

2. Install a new lip seal. Do **NOT** reuse the old lip seal (Figure 26).

NOTE: Apply a small amount of petroleum jelly to the lip seal to keep it in place on the CVT.

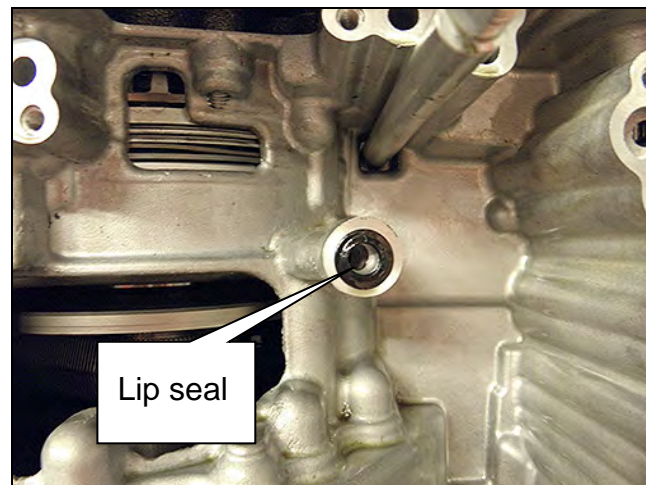

Figure 26

3. Install the Control Valve with eleven (11) mounting bolts (Figure 27).

IMPORTANT: Leave Four (4) ✘ bolt holes blank at this step.

CAUTION: Make sure the wiring harness does not get pinched (see Figures 28 and 29 for correct routing).

- 54 mm long bolt ● – 7 pieces
- 44 mm long bolt ● – 2 piece
- 25 mm long bolt ● – 2 piece

CAUTION: The two 25 mm bolts are installed WITHOUT the strainer bracket.

- Bolt torque: 7.9 N•m (0.81 kg-m, 70 in-lb.)

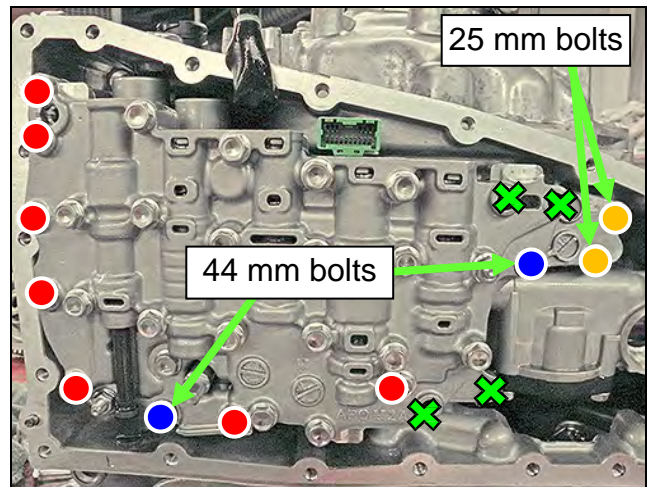

Figure 27

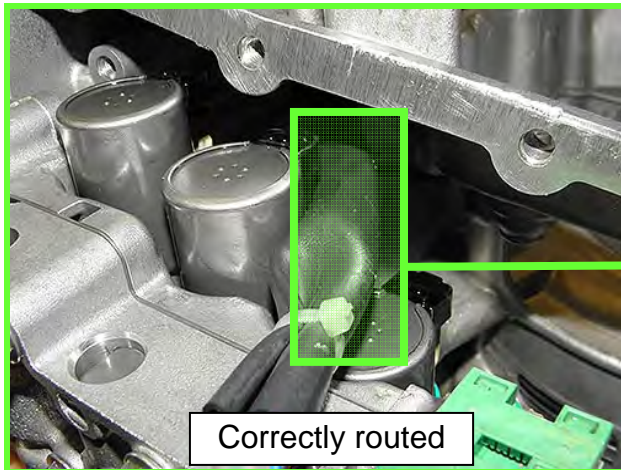

Figure 28

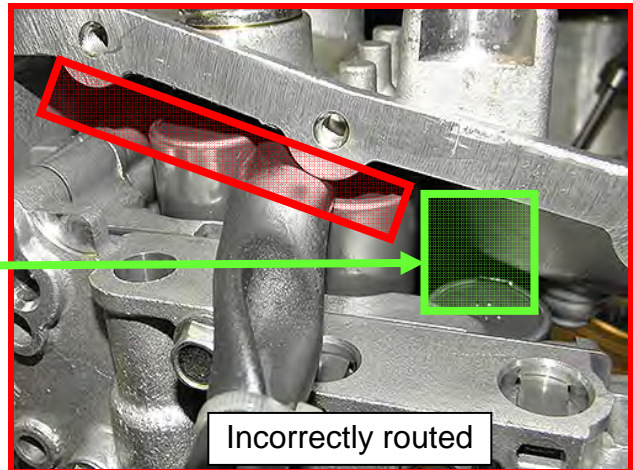

Figure 29

4. Replace the metal bracket of the temperature sensor as follows:

NOTE: The new bracket will be oriented the same way the old bracket was.

- a. Cut the plastic zip tie with an appropriate tool to remove the temperature sensor bracket from the terminal harness assembly. (Figure 30).

CAUTION: Cut the plastic zip tie over the metal bracket to avoid damage to the temperature sensor.

- b. Discard the removed bracket and plastic zip tie.
- c. Use the plastic zip tie from Parts Information to attach the new temperature sensor bracket to the temperature sensor of the terminal connector harness.

IMPORTANT: Locate the plastic zip tie at the **center notch** of three notches on the temperature sensor.

- d. Cut off plastic zip tie excess.

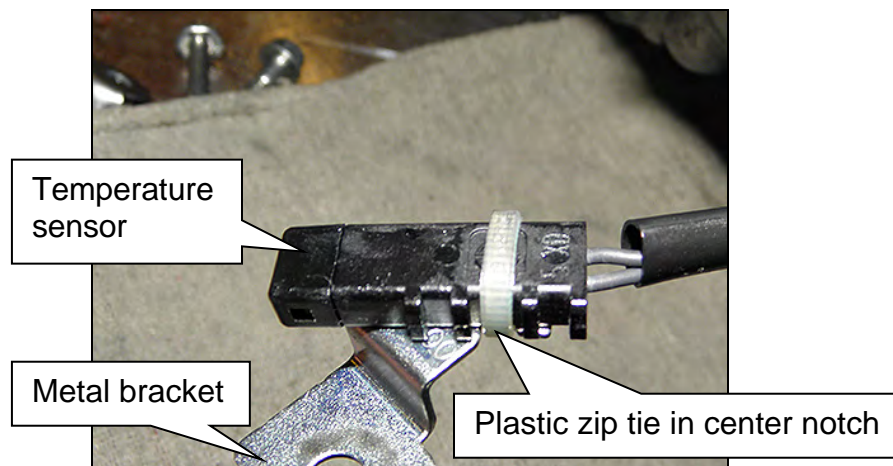

Figure 30

5. Connect the electrical harness connector (Figure 31).

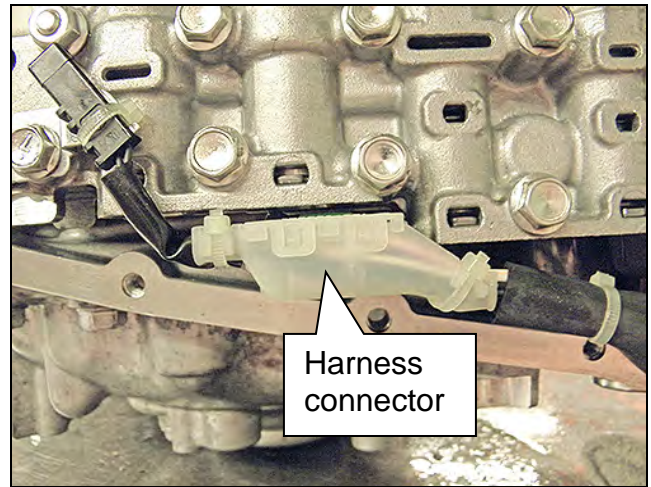

Figure 31

6. Install the CVT fluid temperature sensor bracket to the valve body with one (1) bolt (Figure 32).

NOTE: Leave one (1) bolt hole blank as it will be used to secure the oil strainer at a later step.

- Bolt torque: 7.9 N•m (0.81 kg-m, **70 in-lb.**)
- Bolt length: 54 mm

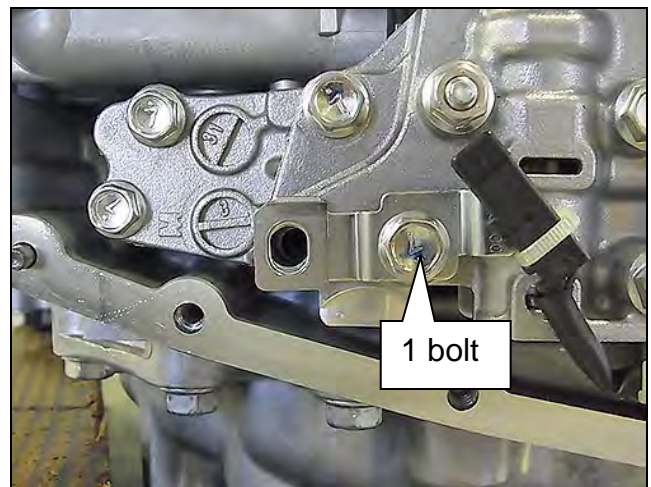



Figure 32

7. Install the new oil strainer with its new O-ring seal with two (2) bolts (Figure 33).

NOTE: replacement strainer maybe a different shape.

- Bolt torque: 7.9 N•m (0.81 kg-m, **70 in-lb.**)
- 54 mm long bolt  - 2 pieces.

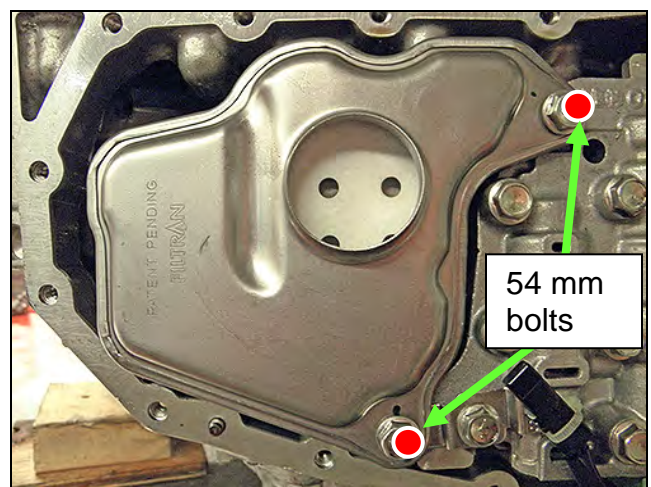

Figure 33

8. Install the manual plate, lock washer, and nut (Figure 34).

NOTE: Make sure the manual plate fits into the slot of the manual valve before applying torque to the nut.

- Reuse the existing manual plate, lock washer, and nut.
- Nut torque: 22.1 N•m (2.3 Kg-m, **16 ft-lb.**)

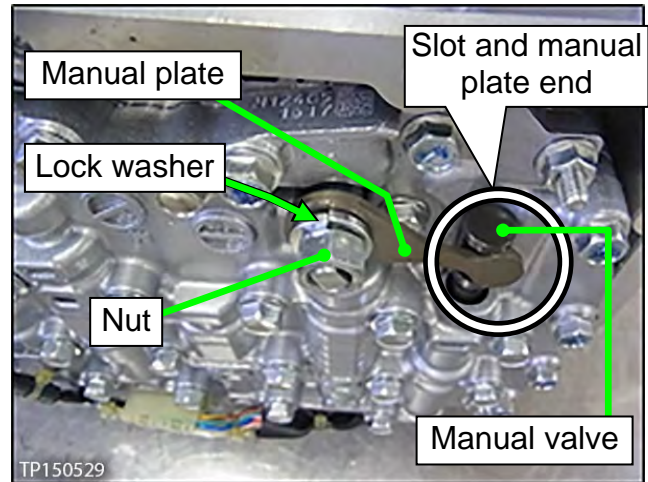

Figure 34

9. Clean the original oil pan and magnets with a suitable cleaner. Visible debris should not be present at re-assembly.

10. Reassemble the original magnets to the pan.

NOTE: Return the magnets to their original locations.

11. Install a new oil pan gasket to the pan.

12. Install the oil pan bolts (see Figure 35).

- Reuse the existing pan bolts.
 - Oil pan bolts torque: 7.9 N•m (0.81 kg-m, **70 in-lb.**)

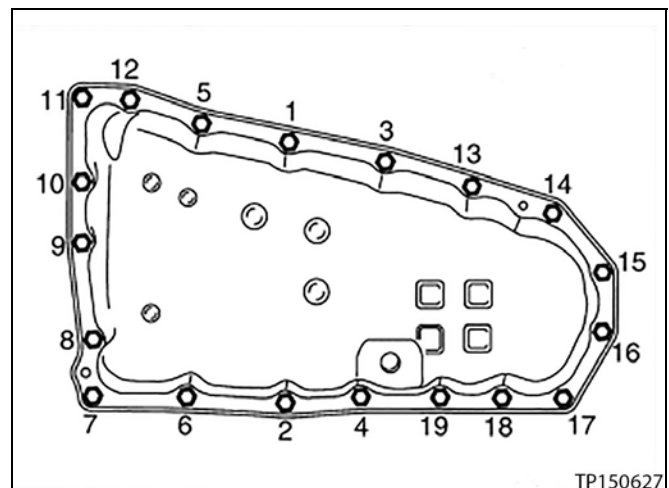

Figure 35

13. Install a new drain washer to the drain plug on the oil pan.

14. Fill the CVT assembly with NS-3 CVT fluid or equivalent.

- Refer to the ESM, section **TM – Transaxle & Transmission** for CVT fluid filling.

15. **IMPORTANT:** Perform "**ADDITIONAL SERVICE WHEN REPLACING CONTROL VALVE**".

- Refer to **TM – Transaxle & Transmission / BASIC INSPECTION**.
 - Check for fluid leakage.
 - Install Write IP Characteristics to the TCM.
 - Perform Clutch Point Learning
 - Perform Select Learning (Drive/Reverse Learning)
 - Erase CVT Fluid Degradation Level Data
 - Attach the QR label with the new calibration data onto the transmission range switch (inhibitor switch)
 - See Figure 36 and 37 below.
 - A QR Label and CD-R are included with the replacement valve body.

16. Erase the DTC.

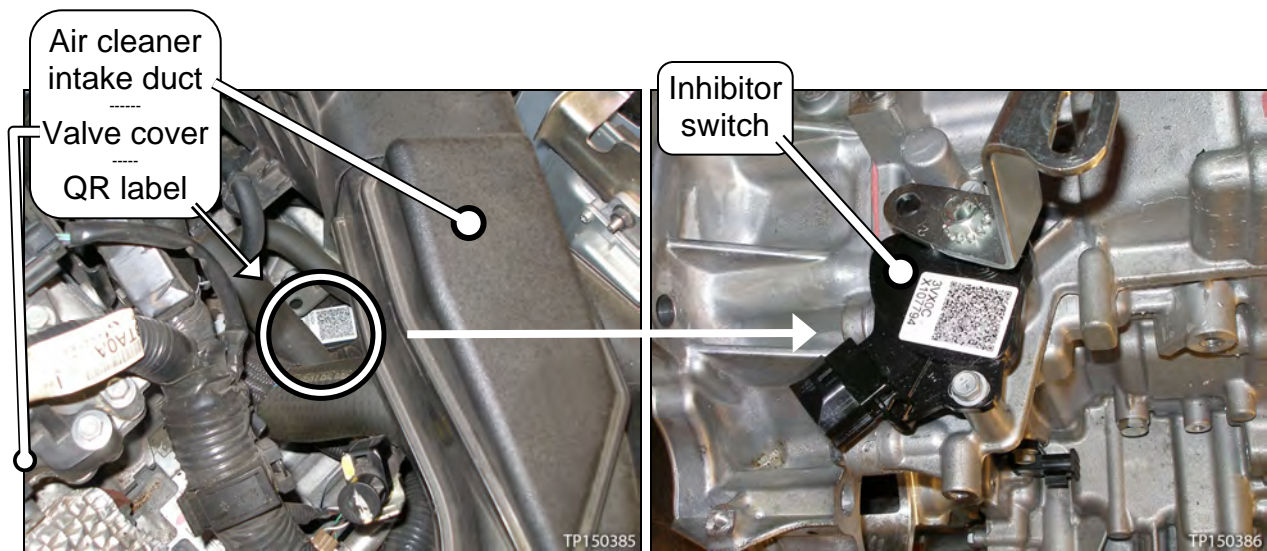

Figure 36

Figure 37

PARTS INFORMATION

DESCRIPTION	PART NUMBER	QUANTITY
CVT ASSEMBLY (1)	(2)	1
VALVE ASSY KIT-CONTROL (3)	3170E-29X9C	1
WASHER-DRAIN	11026-JA00A	1
O-RING EXTERNAL OIL COOLER O-RING (PATHFINDER ONLY)	22180-9NB0A	2
NS-3 CVT Fluid (4) (5)	999MP-NS300P	As needed
Lens Swab (6)	J-51963 (Shop Supply)	As needed

- (1) If the CVT assembly is being replaced, no other parts in the table above, except NS-3 CVT fluid or equivalent, is needed.
- (2) Refer to the electronic parts catalog (FAST or equivalent) for the correct part number.
- (3) Includes QR Label, CD-R, and Control Valve Assembly.
- (4) For warranty repairs, Nissan NS-3 CVT Fluid **must** be used. For customer pay repairs, Nissan NS-3 CVT Fluid or an equivalent is recommended.
- (5) NS-3 CVT Fluid can be ordered through the Nissan Maintenance Advantage program: Phone: 877-NIS-NMA1 (877-647-6621) or Website: Order via link on dealer portal www.NNAnet.com and click on the "Maintenance Advantage" link.
- (6) Lens swabs are available from Tech•Mate online: www.nissantechmate.com. Or by phone: 1-800-662-2001.

Tech Cam J-51951

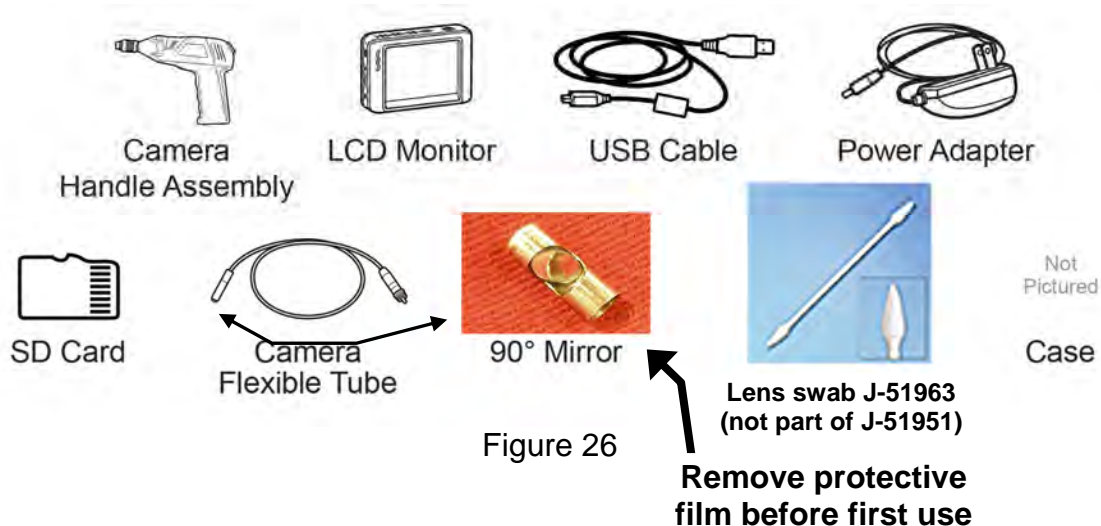

Additional kits and individual components of Tech Cam J-51951 are available from Tech•Mate online: www.nissantechmate.com. Or by phone: 1-800-662-2001.

CLAIMS INFORMATION

NOTE: Refer to CVT Assembly Replacement Approval Procedures before submitting a claim.

Submit a Primary Part (PP) type line claim using the following claims coding:

If DTC P17F0 is stored

MODEL	DESCRIPTION	PFP	OP CODE	SYM	DIA	FRT
All Models	CVT R&R	(1)	JD01AA JD023A	(2)	32	(3)
	CVT TROUBLE DIAGNOSIS		JX22AA			0.5

(1) Reference the electronic Parts Catalog (FAST or equivalent) and use the CVT assembly part number for the vehicle being repaired as the Primary Failed Part.

(2) Use the Symptom and Diagnostic codes that apply to the repair actually performed.

(3) Reference the current Nissan Warranty Flat Rate Manual and use the indicated Flat Rate Time.

NOTE: FRT allows adequate time to access DTC codes. No other diagnostic procedures subsequently required. Do NOT claim any diagnostic OP Codes with this claim.

OR

If DTC P17F1 is stored and Control Valve is replaced (chain inspection shows no signs of chain slip, OK)

MODEL	DESCRIPTION	PFP	OP CODE	SYM	DIA	FRT
All Models	RPL CVT CONTROL VALVE ASSY	3170E-29X9C	JD48AA	ZE	32	(1)

(1) Reference the current Nissan Warranty Flat Rate Manual and use the indicated Flat Rate Time.

NOTE: FRT allows adequate time to access DTC codes. No other diagnostic procedures subsequently required. Do NOT claim any diagnostic OP Codes with this claim.

and

MODEL	DESCRIPTION	OP CODE	FRT
All Models	Inspect CVT Chain, Chain = OK	JX37AA	0.3

OR (see next page)

If DTC P17F1 is stored and chain inspection shows signs of Chain slip (NG) CVT is replaced

MODEL	DESCRIPTION	PPF	OP CODE	SYM	DIA	FRT
All Models	CVT R&R	(1)	JD01AA JD023A	ZE	32	(2)
	CVT TROUBLE DIAGNOSIS		JX22AA			0.5

(1) Reference the electronic Parts Catalog (FAST or equivalent) and use the CVT assembly part number for the vehicle being repaired as the Primary Failed Part.

(2) Reference the current Nissan Warranty Flat Rate Manual and use the indicated Flat Rate Time.

NOTE: FRT allows adequate time to access DTC codes. No other diagnostic procedures subsequently required. Do NOT claim any diagnostic OP Codes with this claim.

and

MODEL	DESCRIPTION	OP CODE	FRT
Quest, Maxima	Inspect CVT Chain, Chain = NG (includes control valve R&I)	JX36AA	2.2
Altima V6			2.3
Pathfinder, Murano			2.4

CVT Assembly Replacement Approval Procedures

- If P17F0 is stored for CVT replacement:
 - a. Complete the Powertrain Call Center (PCC) CVT Preauthorization Form in ASIST.
 - b. Attach the C-III plus screen printouts showing the VIN and DTC to the Preauthorization Form.
 - c. Call the PCC for authorization at **800-973-9992 (opt 2)**.

- If P17F1 is stored and CVT chain inspection indicates **CVT assembly** replacement is required:
 - a. Complete the PCC CVT Preauthorization Form in ASIST.
 - b. Attach the C-III plus screen printouts showing the VIN and DTC to the Preauthorization Form.
 - c. Attach the required video (15 seconds or less) to the CVT Preauthorization Form.
 - Failure to submit a continuous video showing evidence of chain slip and the VIN will cause immediate denial of request for CVT unit replacement.
 - d. Call the PCC for authorization at **800-973-9992 (opt 2)**.

IMPORTANT: Make sure the video has a clear image of the VIN on the F.M.V.S.S. certification label (VIN label).