

SUPPLEMENTAL TECHNICAL INSTRUCTIONS

FOR

SPECIAL SERVICE CAMPAIGN F0U

ANCILLARY PART REPLACEMENT

- OUTER DASH PANEL INSULATOR**
- ENGINE ROOM MAIN WIRE HARNESS**
- ENGINE WIRE HARNESS**

CERTAIN 2010- 2014 MODEL YEAR TACOMA 2TR-FE VEHICLES

The repair quality of covered vehicles is extremely important to Toyota. All dealership technicians performing this procedure are required to successfully complete the most current version of the E-Learning course "Safety Recall and Service Campaign Essentials" To ensure that all vehicles have the repair performed correctly; technicians are required to currently hold at least one of the following certification levels to perform this operation:

- *Toyota Certified
- *Toyota Expert
- Master
- Master Diagnostic Technicians
- *Note: Certified technicians can perform the inspection and catalytic converter replacement, however if the inspection determines that the vehicle requires additional electrical repairs it must be performed by a technician that is Toyota Expert or above.

It is the dealership's responsibility to select technicians with the above certification level or greater to perform this repair. Carefully review your resources, the technician skill level, and ability before assigning technicians to this repair. It is important to consider technician days off and vacation schedules to ensure there are properly trained technicians available to perform this repair at all times.

I. OPERATION FLOW CHART

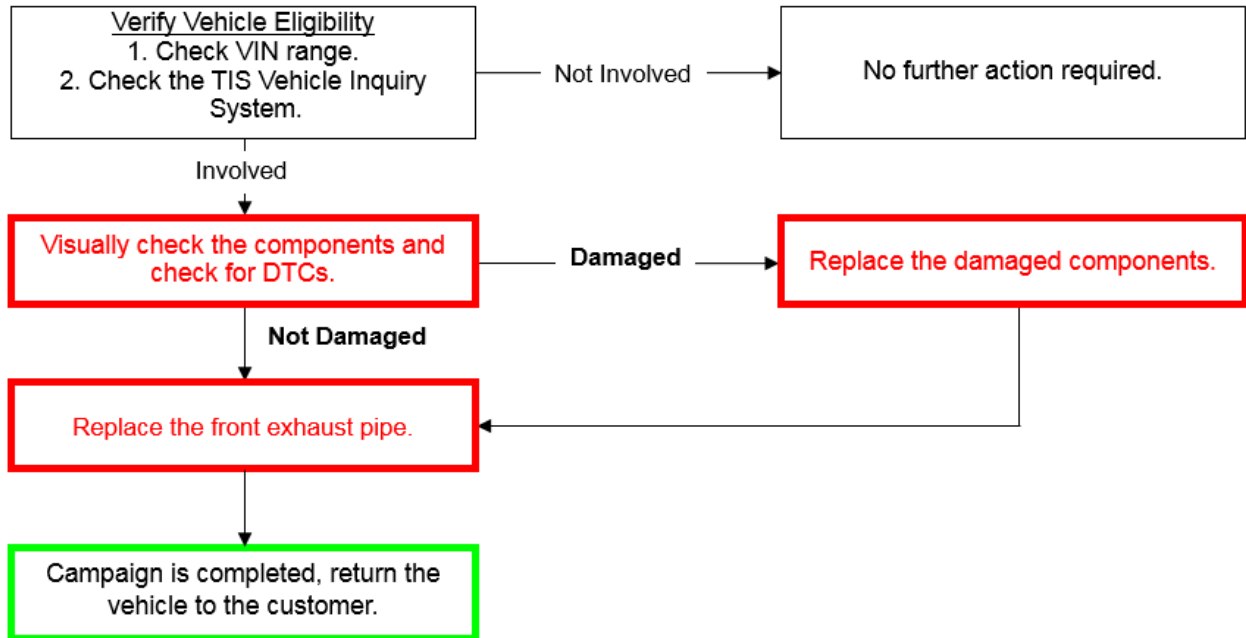

II. IDENTIFICATION OF AFFECTED VEHICLES

A. COVERED VIN RANGE

- Check the TIS Vehicle Inquiry System to confirm the VIN is involved in this Safety Recall, and that the campaign has not already been completed prior to dealer shipment or by another dealer.
- TMS warranty will not reimburse dealers for repairs conducted on vehicles that are not affected or were completed by another dealer.

III. PREPARATION

A. PARTS

ANCILLARY PARTS ARE ONLY REPLACED AS NEED BASED ON THE VEHICLE INSPECTION. PRIOR TO REPLACING ANY ANCILLARY COMPONENTS, IT IS REQUIRED THAT A TAS CASE IS CREATED AND THAT FTS APPROVAL IS PROVIDED BEFORE PROCEEDING.

B. TOOLS & EQUIPMENT

- Techstream
- Standard Hand Tools
- Vernier Calipers
- Protective Glasses
- Wooden Pieces
- Inspection Mirror
- Protective Gloves
- Torque Wrench

SST- These are essential special service tools that the dealership should have.

Part Number	Description	Quantity
09224-00010	O2 Sensor Wrench	1

IV. BACKGROUND

In the subject vehicles the front catalytic converter internal components may become deteriorated and begin to rattle. If continually operated in this condition, the deteriorated components could become dislodged and restrict the exhaust flow. If this occurs, the vehicle may illuminate a check engine light, and, depending on the level of exhaust restriction, the vehicle may experience a reduction in power.

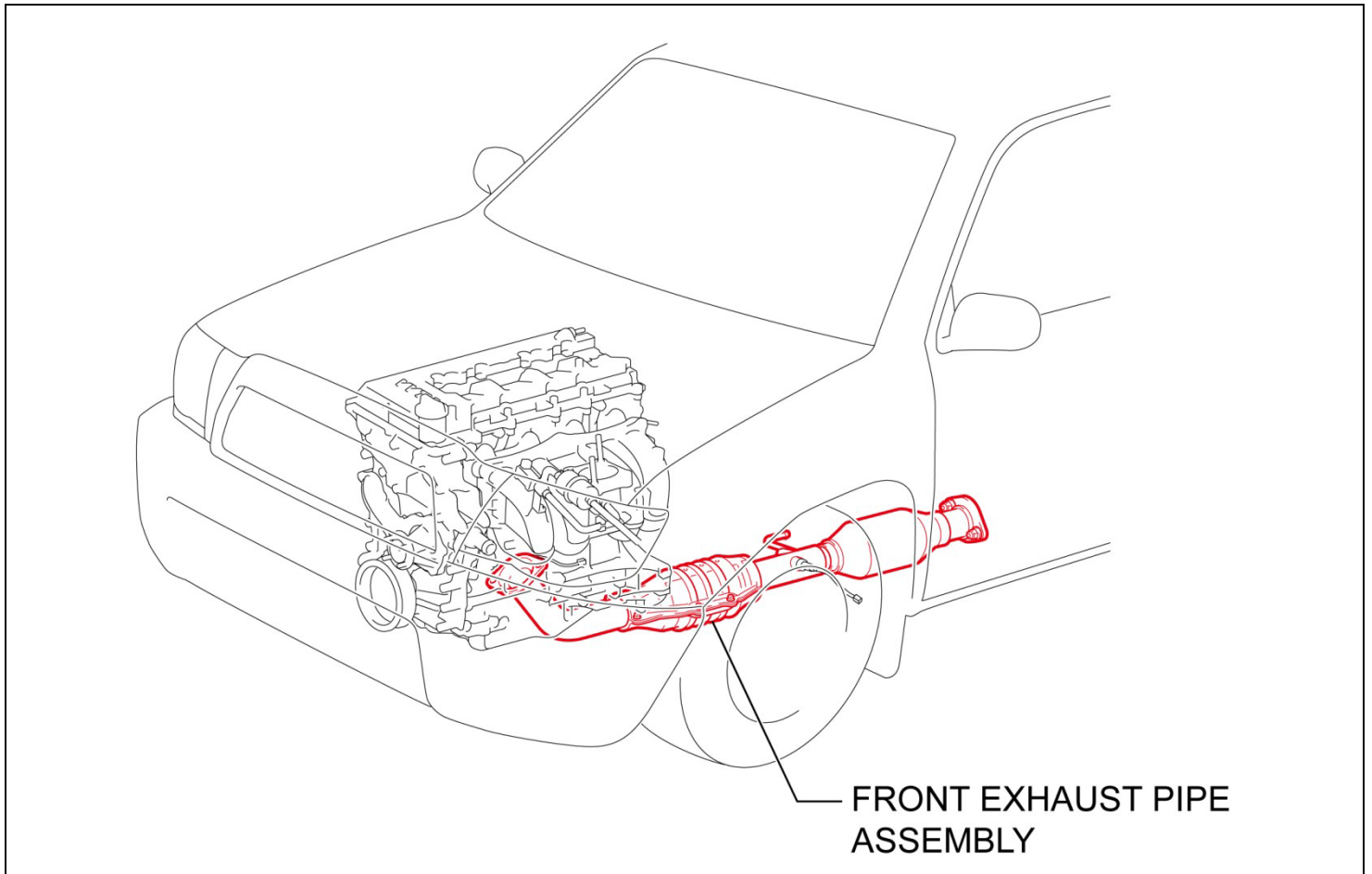

V. TABLE OF CONTENT

- **Section VI-Brake Tube Clamp Replacement**
- **Section VII- Outer Dash Panel Insulator Replacement**
- **Section VII- Engine Room Main Wire Harness Replacement**
- **Section IX- Engine Wire Harness Replacement**
- **Section X- Final Vehicle Check (required for all repairs)**

Note: The supplemental TI is only intended to cover components that do not have direct repair manual instructions, if other components are in need of replacement that are not covered by this TI please refer to the repair manual.

VI. BRAKE TUBE CLAMP REPLACEMENT

COMPONENTS TO BE REPLACED/REMOVED OVERVIEW

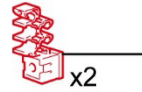
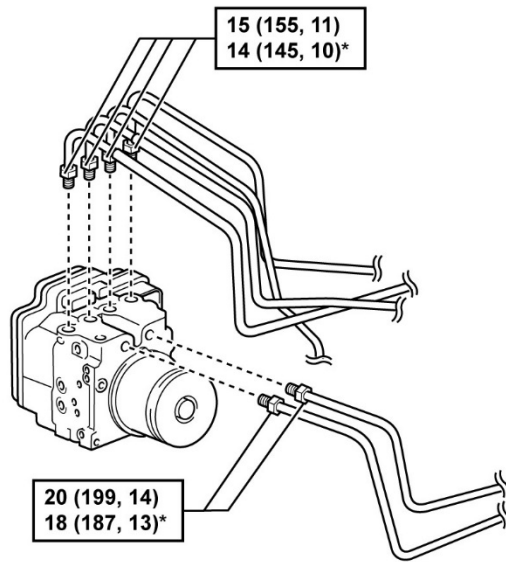

● BRAKE TUBE CLAMP NO.6

● :Component to be replaced

N*m (kgf*cm, ft.*lbf) : Specified torque

* For use with union nut wrench

S58043aS

A. VEHICLE DISASSEMBLY

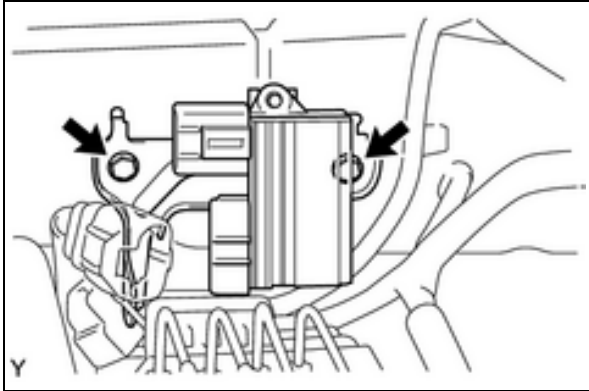

1. TEMPORARILY RELOCATE THE AIR INJECTION DRIVER

- Remove the 2 bolts securing the air injection driver to the inner passenger fender.
- Temporarily relocate the driver to give you additional room to move the actuator assembly.

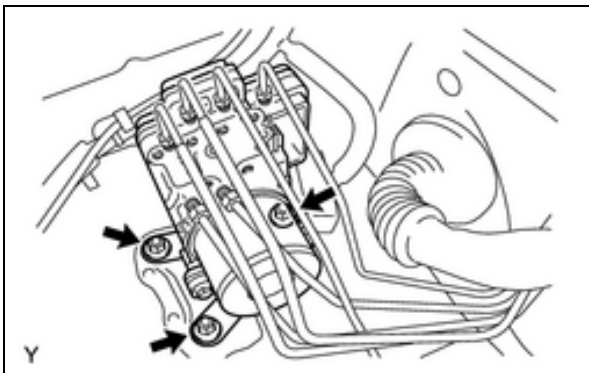

2. REMOVE BRAKE ACTUATOR NUTS

- Remove the 3 brake actuator bracket nuts that secure it to the wheel well.

Note: By loosening the brake actuator it gives you more flex in the brake lines so that the brake tube clamps can be replaced.



Always gently move the brake tubes when replacing the brake tube clamps.

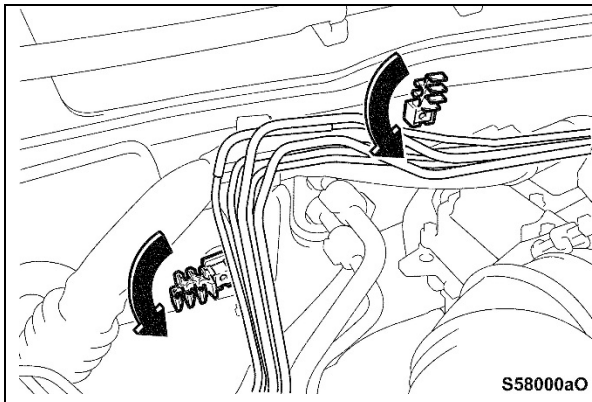

3. REMOVE THE HEAT DAMAGED BRAKE TUBE CLAMPS

- a) Carefully disengage the brake tube bracket from the brake tube.
- b) Turn the brake tube clamps in the direction shown to remove them from the studs.

STOP *Always gently move the brake tubes when replacing the brake tube clamps.*

B. VEHICLE REASSEMBLY

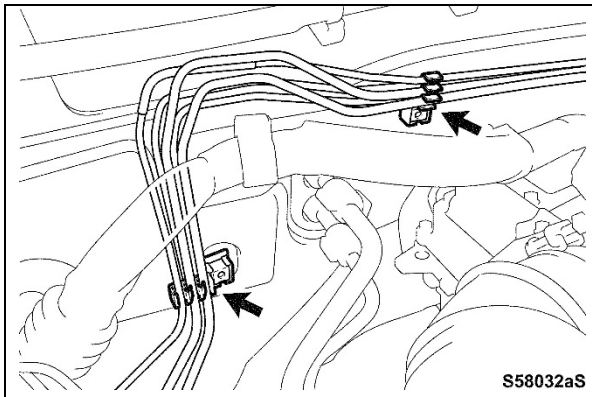

1. INSTALL THE **NEW** BRAKE TUBE CLAMPS

- a) Set the 5 brake tubes into the 2 **NEW** clamps.
- b) Install the 2 new clamps onto the studs.

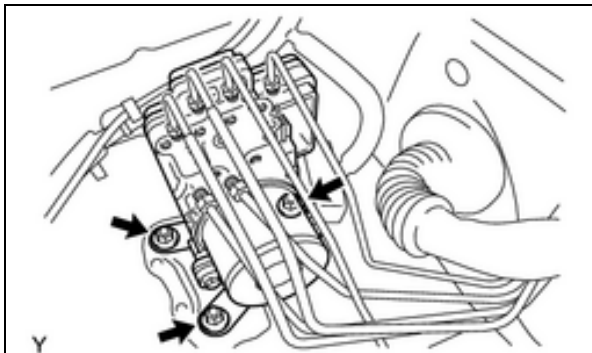

2. REINSTALL THE BRAKE ACTUATOR

- a) Reinstall the 3 nuts and torque to specification.

Torque Spec: 19 Nm (194 kgf-cm, 14ft-lbf)

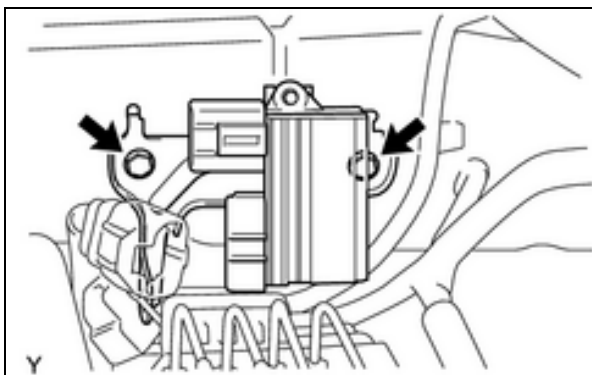

3. REINSTALL THE AIR INJECTION DRIVER

- a) Insert the bracket tabs into the fender guide holes and reinstall the 2 nuts.

Torque Spec: 10 Nm (102 kgf-cm, 7 ft-lbf)

4. PROCEED TO SECTION X: FINAL VEHICLE CHECK

5.

VII. OUTER DASH PANEL INSULATOR REPLACEMENT

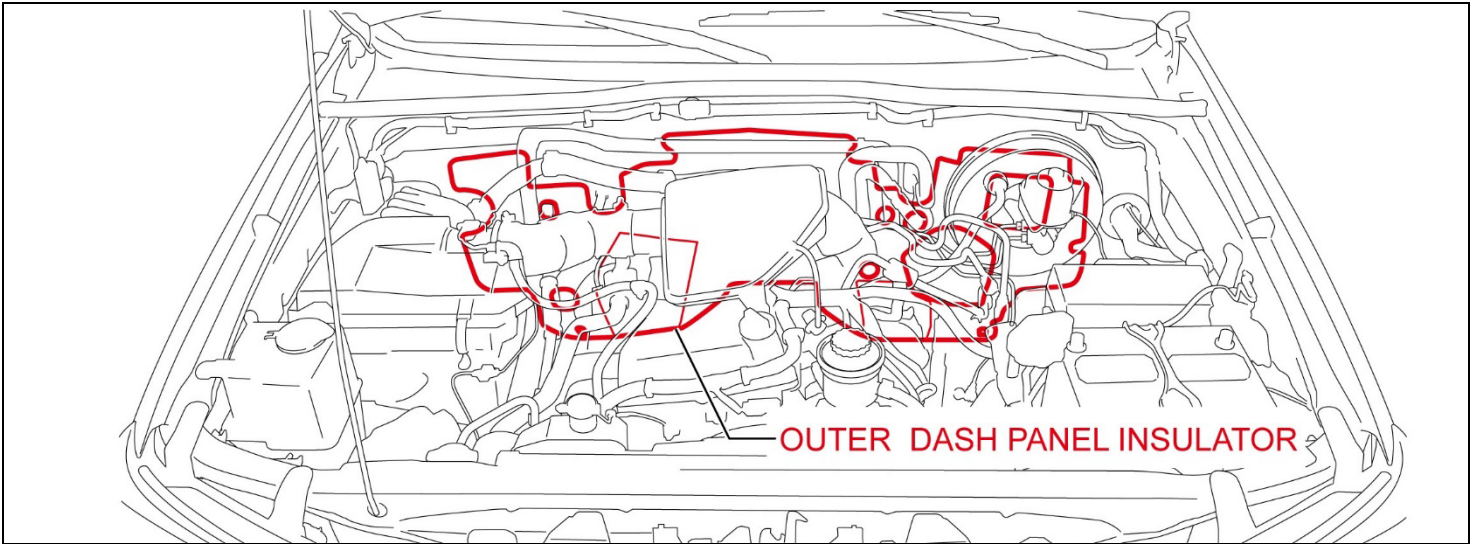

COMPONENTS TO BE REPLACED/REMOVED OVERVIEW

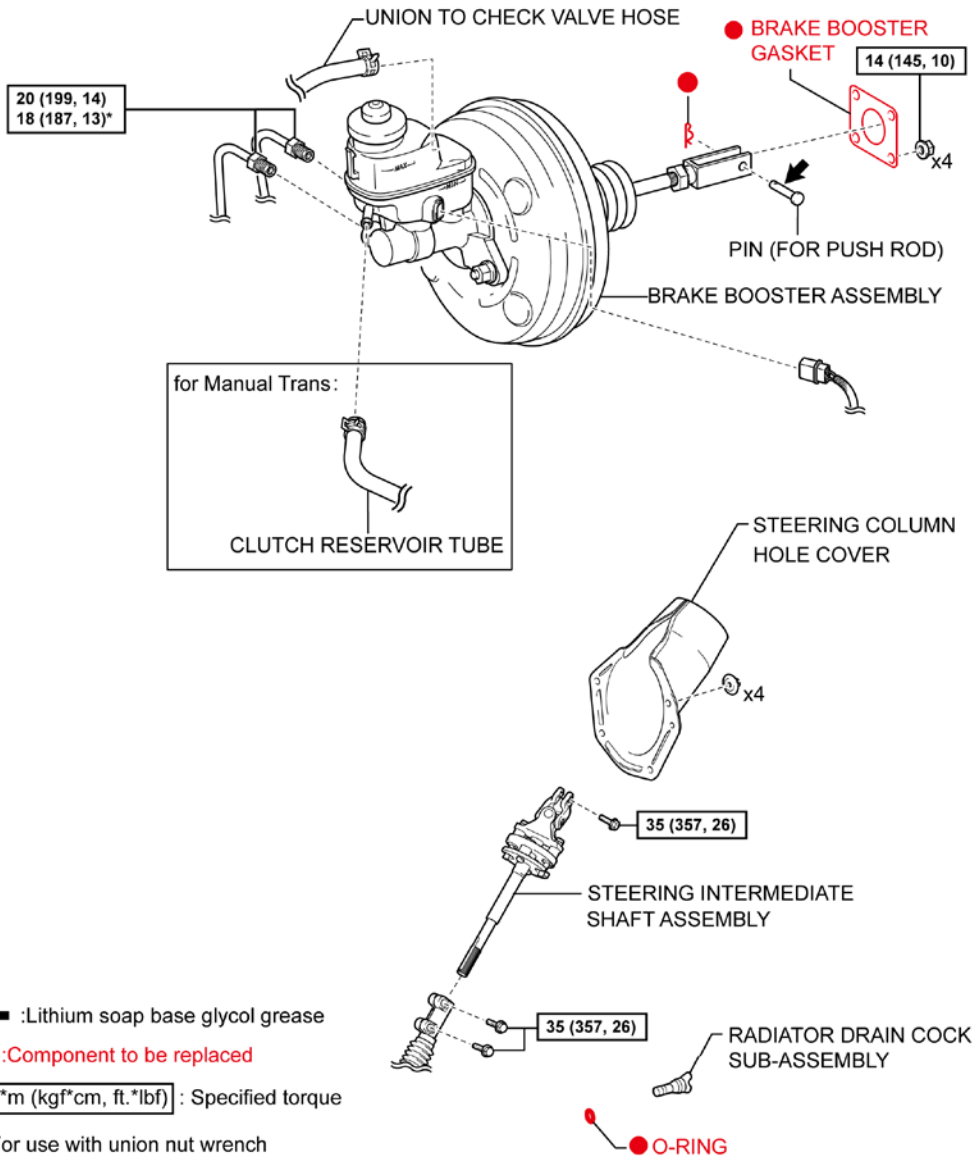

COMPONENTS TO BE REPLACED/REMOVED OVERVIEW CONTINUED...

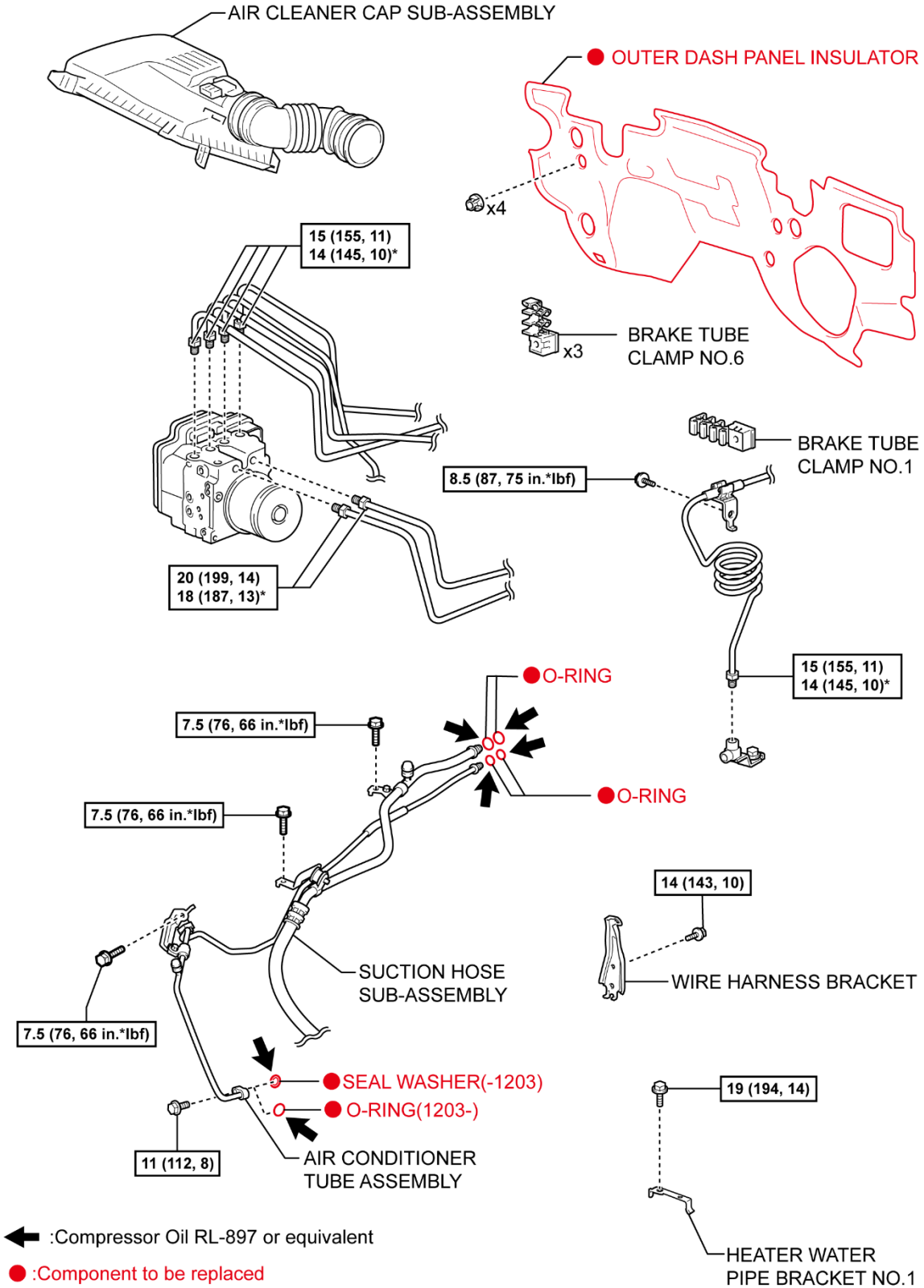

← : Compressor Oil RL-897 or equivalent

● : Component to be replaced

N*m (kgf*cm, ft.*lbf) : Specified torque

* For use with union nut wrench

S58030aS



- Always use caution when working in the engine bay because many sharp edges are exposed.
- The following procedure is intended to help guide you, always use the repair manual links to help with the detailed procedure for certain component removal.

A. OUTER DASH PANEL INSULATOR REPLACEMENT

1. EVACUATE A/C REFRIGERANT
2. DRAIN ENGINE COOLANT

ENGINE COOLANT DRAIN RM LINK

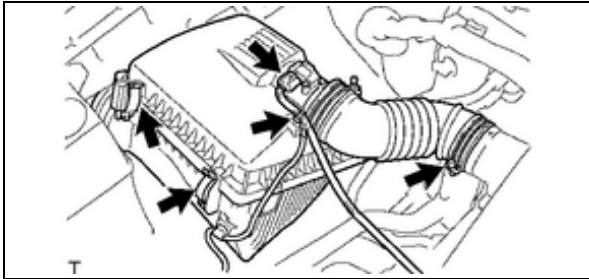

3. REMOVE AIR CLEANER CAP SUB-ASSEMBLY

- a) Disconnect the mass air flow meter connector.
- b) Disconnect the wire harness clamp.
- c) Loosen the hose clamp bolt, then disconnect the air cleaner hose No. 1.
- d) Disconnect the 2 air cleaner clamps.
- e) Remove the air cleaner cap together with the air cleaner hose No. 1.

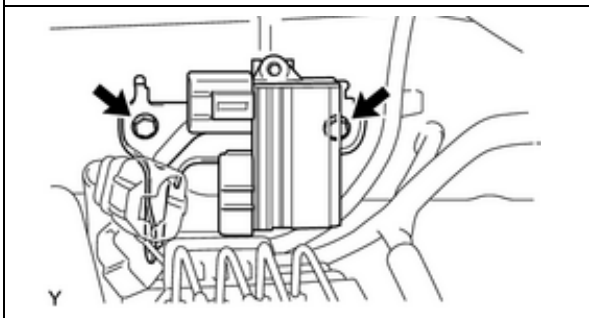

4. REMOVE BRAKE TUBES FROM ACTUATOR

- a) Remove the 2 bolts securing the air injection driver to the inner passenger fender.
- b) Temporarily relocate the driver to give you additional room to access the actuator.

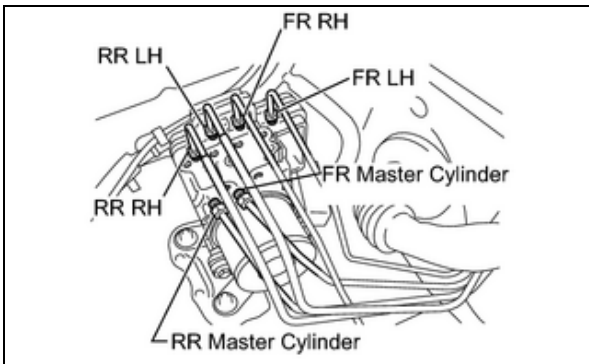

- c) Label the brake tubes so they return to the correct location.

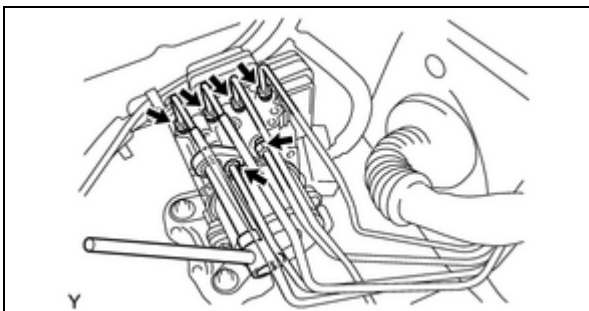

- d) Using a union nut wrench, separate the brake tubes from the actuator.

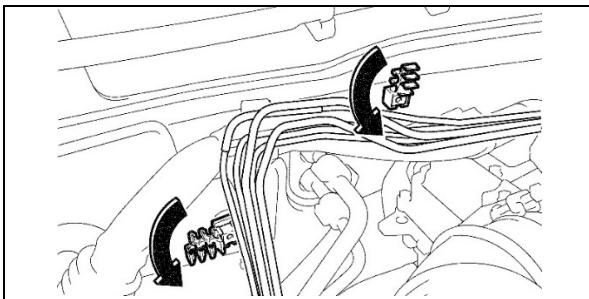

- e) Separate the brake tubes from the brake tube brackets from the 4 locations.
- f) Remove the brake tube brackets as shown.

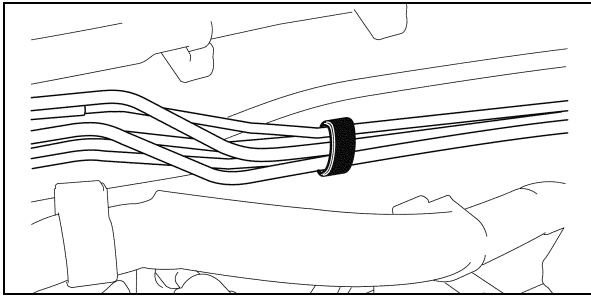

g) Bind the brake tubes together with vinyl tape.

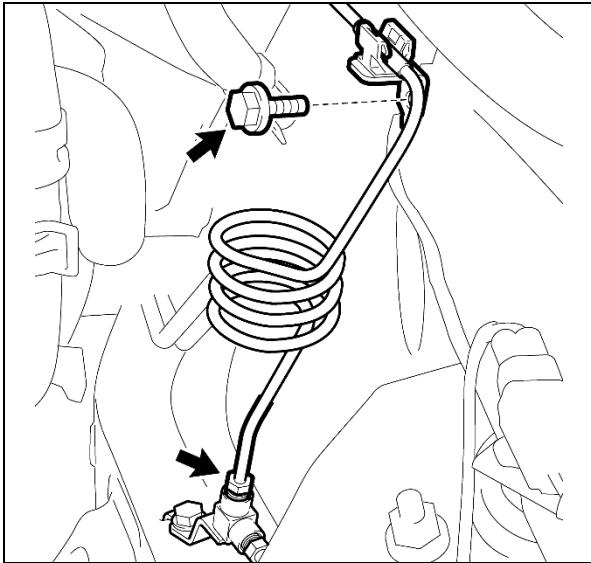

h) Disconnect the No. 5 front brake tube.

i) Remove the brake tube clamp bolt.

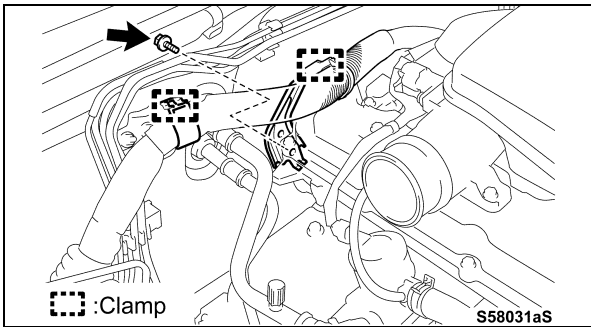

5. REMOVE WIRE HARNESS BRACKET

a) Disengage the 2 clamps.

b) Remove the bolt and wire harness bracket.

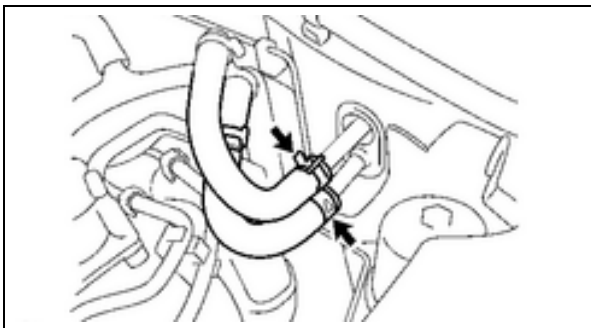

6. SEPARATE WATER HOSE

a) Remove the hose clamps and remove the coolant hoses.

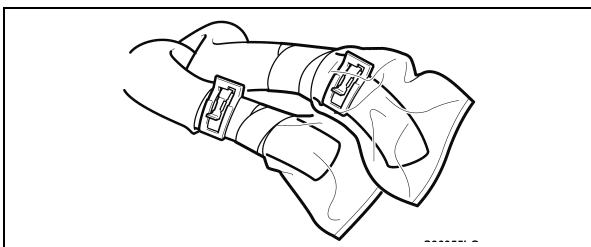

b) Cover water hoses with plastic bags to ensure foreign objects do not enter the system.

7. REMOVE BRAKE BOOSTER ASSEMBLY

[BRAKE BOOSTER REMOVAL RM LINK](#)

8. REMOVE STEERING INTERMEDIATE SHAFT

[STEERING INTERMEDIATE SHAFT \(2wd\) RM LINK](#)
[STEERING INTERMEDIATE SHAFT \(4wd\) RM LINK](#)

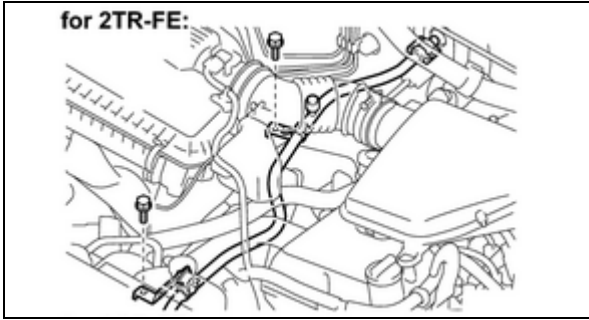

9. DISCONNECT THE A/C SUCTION HOSE

- Remove the 2 bolts.
- Insert 2 screwdrivers into the 2 piping clamp slots, and while holding them down, disengage the piping clamp claws and the piping clamp.
- Disconnect the suction hose.



Never use a screwdriver to pry apart the suction hose from the A/C Unit.

- Remove the O-rings from the suction hoses as they will be replaced.
- Cover the hose and A/C unit line to prevent debris from entering the system.

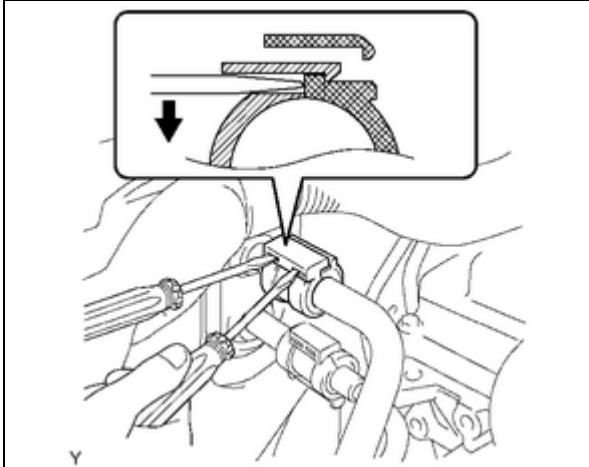

10. DISCONNECT A/C DISCHARGE HOSE

- Remove the bolt.
- Disengage the 2 clamps and separate the A/C discharge hose.
- Insert 2 screwdrivers into the 2 piping clamp slots, and while holding them down, disengage the piping clamp claws and the piping clamp.
- Disconnect the A/C discharge hose.



Never use a screwdriver to pry apart the air conditioning tube from the A/C Unit.

- Remove the O-ring from the air conditioning tube.
- Cover the hose and A/C unit line to prevent debris from entering the system.

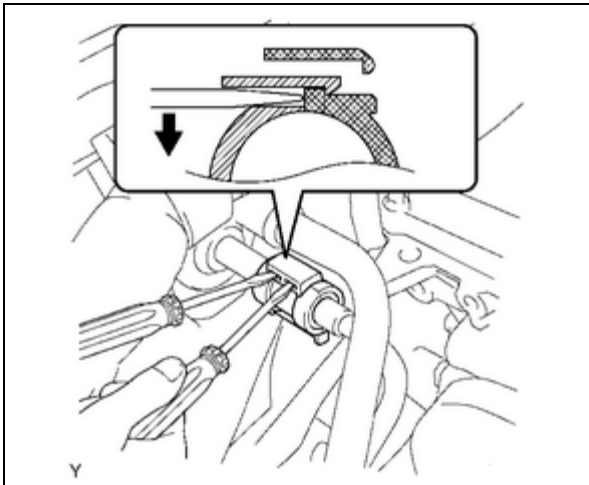

11. TEMPORARILY RELOCATE THE A/C HOSES

- Move the A/C hoses so that they do not interfere with removing the insulator.

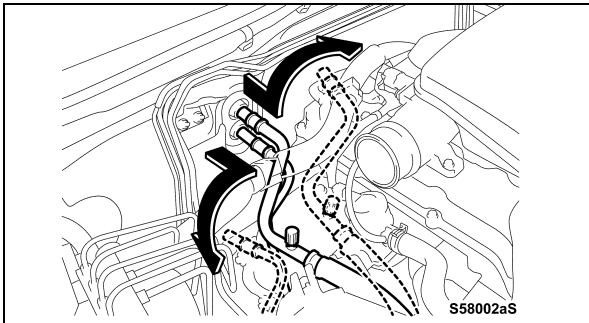

12. REMOVE THE OUTER DASH PANEL INSULATOR

- a) Remove the 4 clips securing the insulator.
- b) Move the brake tubes toward the front of the vehicle to obtain sufficient workspace.
- c) Remove the insulator.

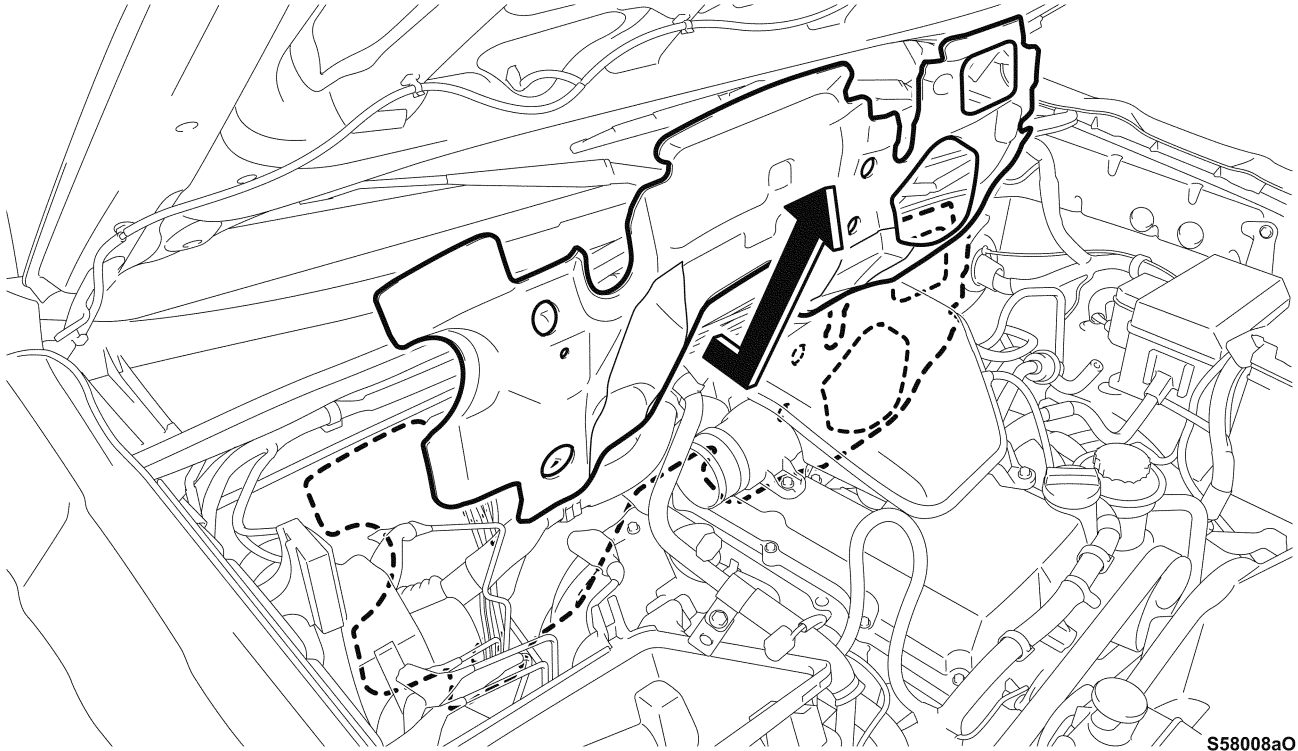

S58008aO

B. **NEW** OUTER DASH PANEL INSULATOR INSTALLATION

1. TAPE THE 5 STUDS WITH PROTECTIVE TAPE

RH Side of the Engine Compartment

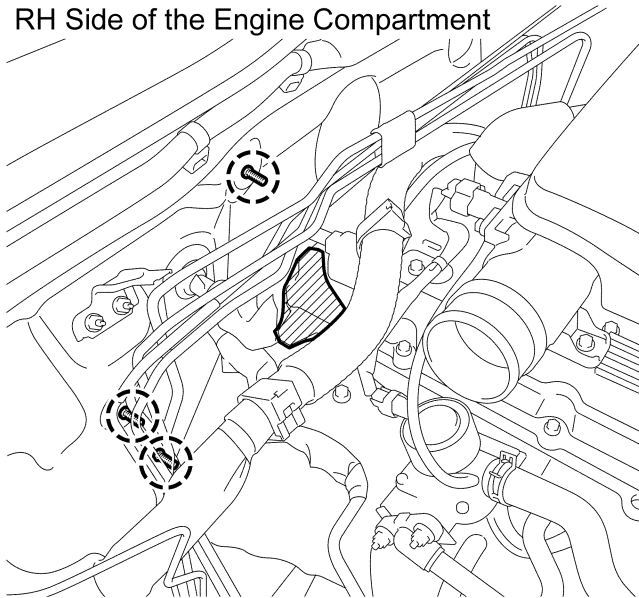

LH Side of the Engine Compartment

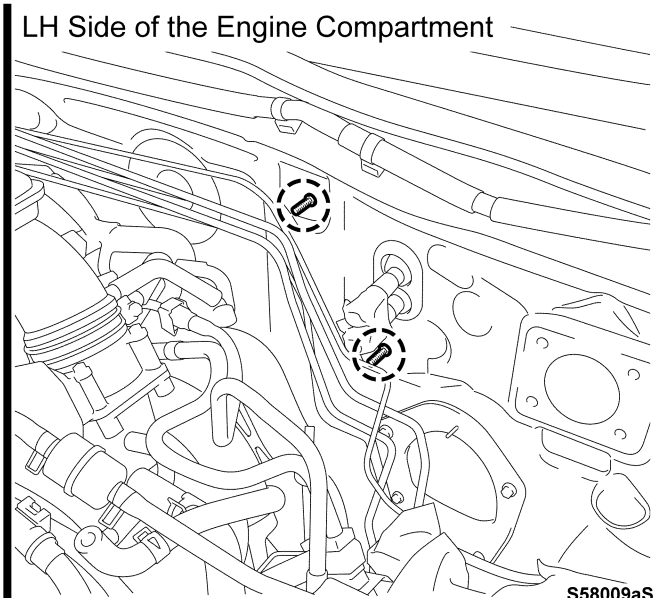

S58009aS

2. INSTALL THE NEW OUTER DASH PANEL INSULATOR

- Move the tubes toward the front of the vehicle to obtain sufficient workspace.
- Carefully install the **NEW** insulator as shown.
- Remove the protective tape from the studs and engine.
- Fasten the insulator with the 4 clips.

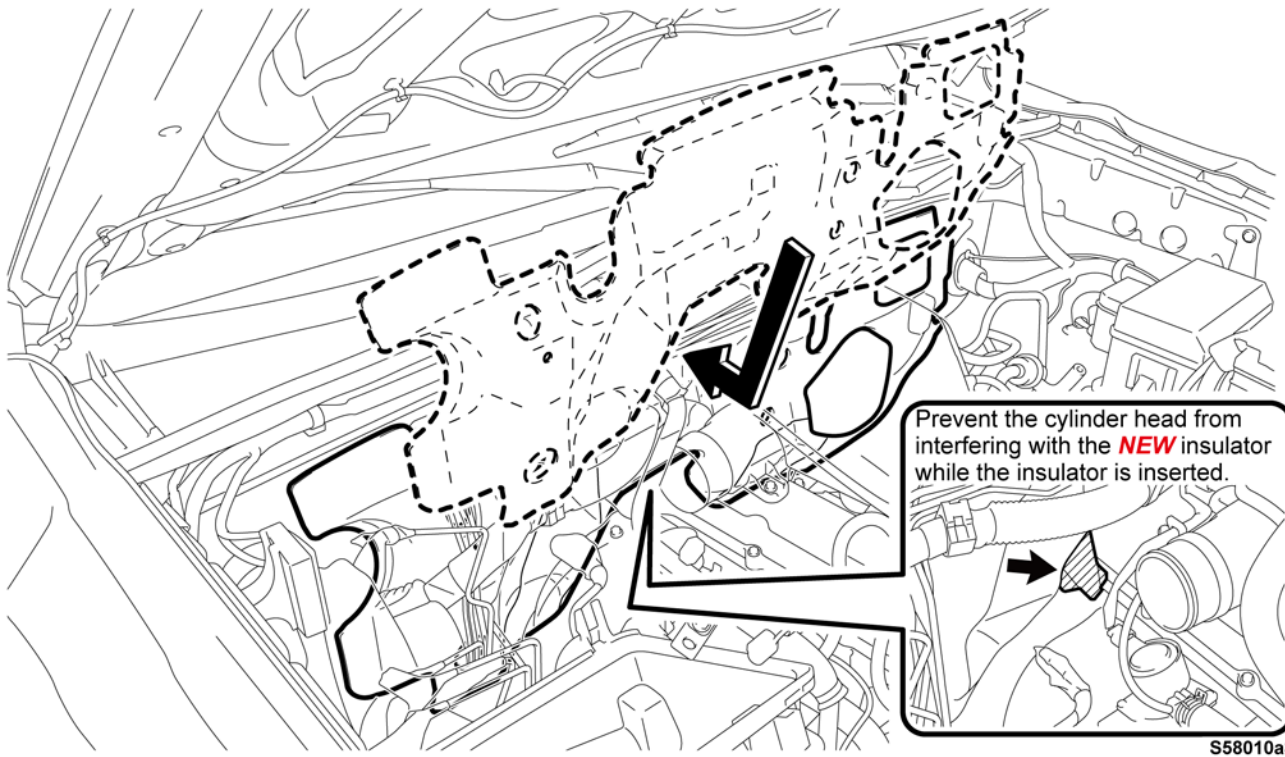

S58010aS

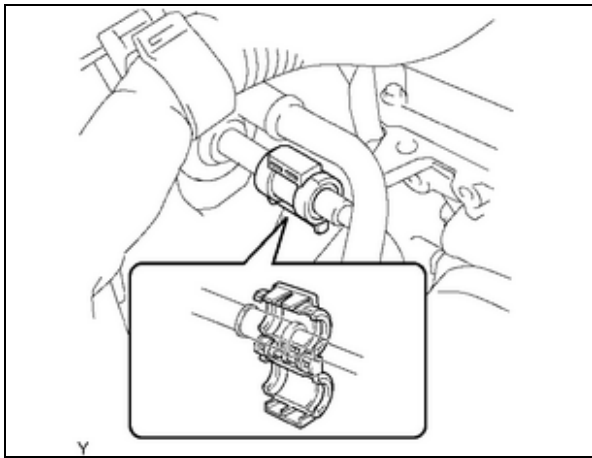

3. REINSTALL THE A/C DISCHARGE HOSE

- a) Apply compressor oil to the 2 **NEW** O-rings and install them.
- b) Install the hose and clamp as shown.

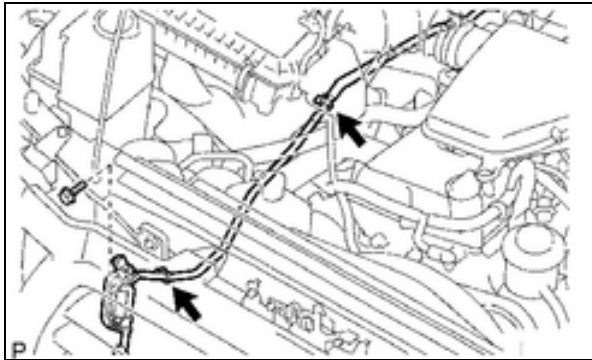

- c) Install the bracket with the bolt and 2 clamps.

Torque Spec: 7.5 Nm (76 kgf-cm, 66in-lbf)

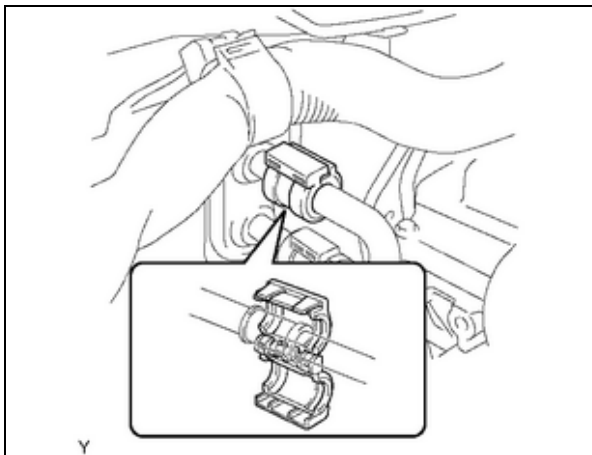

4. REINSTALL THE A/C SUCTION HOSE

- a) Apply compressor oil to the 2 **NEW** O-rings and install them.
- b) Install the hose and clamp as shown.

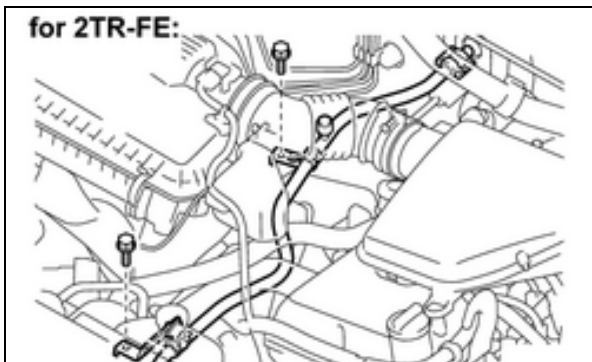

- c) Install the bracket with the 2 bolts.

Torque Spec: 7.5 N-m (76 kgf-cm, 66in-lbf)

13. REINSTALL STEERING INTERMEDIATE SHAFT

[STEERING INTERMEDIATE SHAFT \(2wd\) RM LINK](#)
[STEERING INTERMEDIATE SHAFT \(4wd\) RM LINK](#)

14. REINSTALL BRAKE BOOSTER ASSEMBLY

[BRAKE BOOSTER REINSTALLATION RM LINK](#)

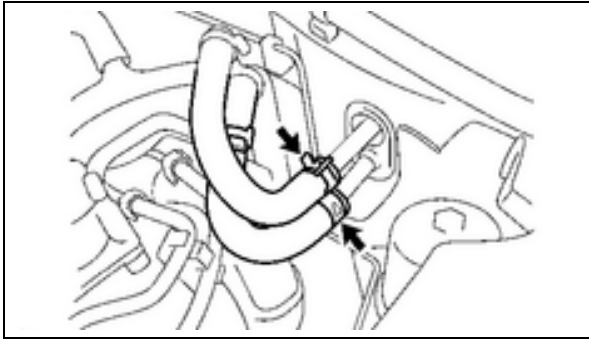

15. REINSTALL WATER HOSE

- a) Remove the plastic bags from the water hoses.
- b) Reinstall the hoses and secure with the hoses clamps.

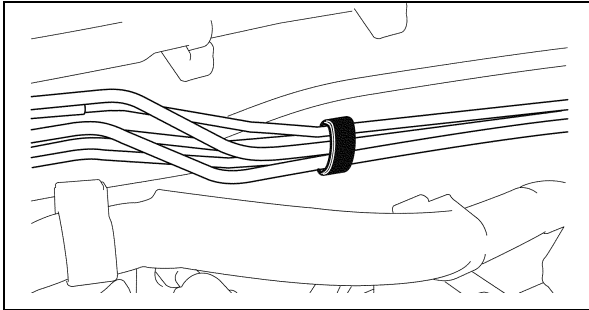

16. REINSTALL BRAKE TUBES TO ACTUATOR

- a) Remove the vinyl tape from the brake tubes.

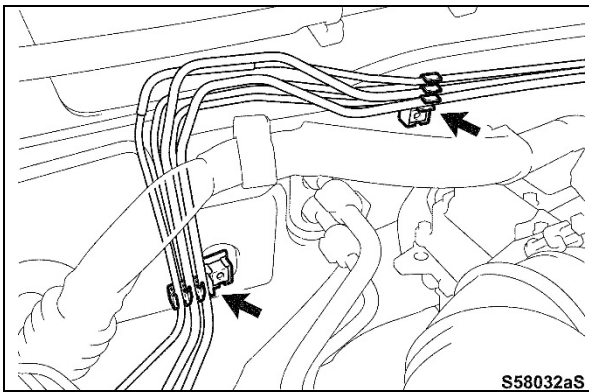

- b) Install the 4 brake tube clamps

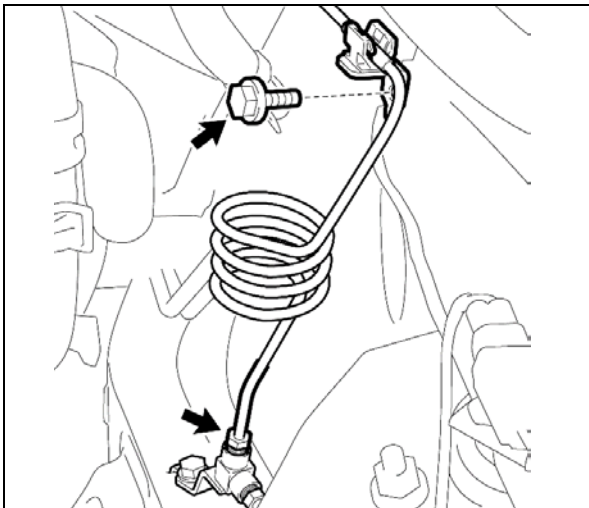

- c) Reinstall the front No. 5 brake line.

Torque Spec: 15 Nm (87 kgf-cm, 11ft-lbs)

- d) Reinstall the brake bracket bolt.

Torque Spec: 8.5 Nm (56 kgf-cm, 75in-lbs)

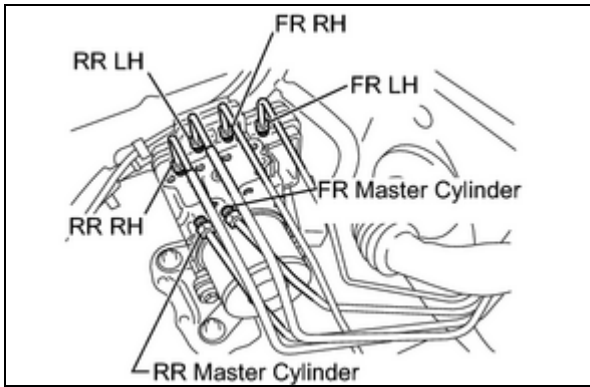

- e) Temporarily install the brake tubes in the correct locations.
- f) Remove the labels from the brake tubes

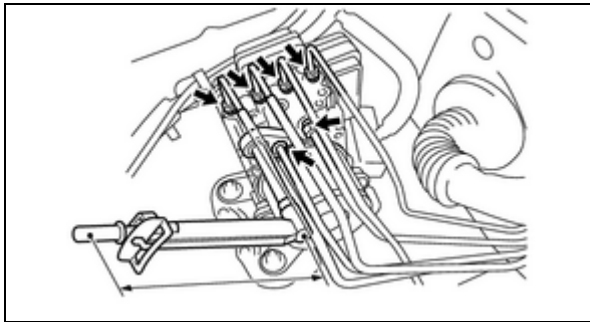

- g) Using a union nut wrench torque the brake tubes.

Torque for 10mm line nut:	
without union nut wrench	with union nut wrench
15 Nm (155 kgf·cm, 11ft·lbf)	14 Nm (145 kgf·cm, 10ft·lbf)

Torque for 12mm line nut:	
without union nut wrench	with union nut wrench
20 Nm (199 kgf·cm, 14ft·lbf)	18 Nm (187 kgf·cm, 13ft·lbf)

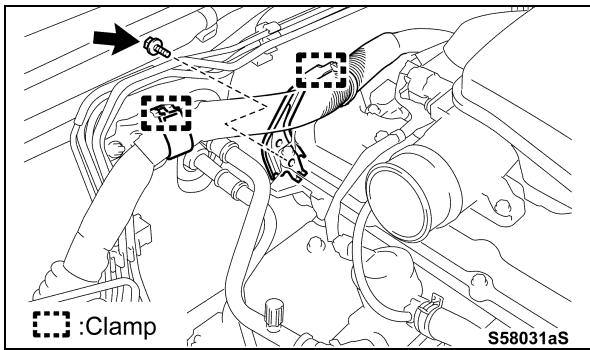

17. REINSTALL WIRE HARNESS BRACKET

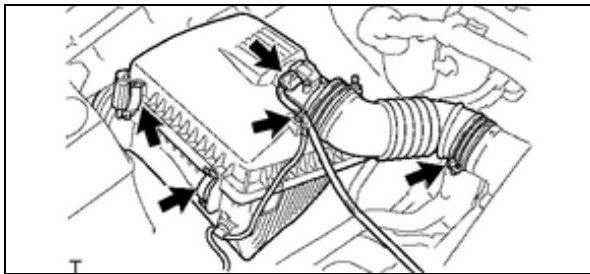

18. REINSTALL AIR CLEANER CAP SUB-ASSEMBLY

- f) Reinstall the air cleaner cap together with the air cleaner hose No. 1.
- g) Connect the 2 air cleaner clamps.
- h) Tighten the hose clamp bolt.
- i) Connect the mass air flow meter connector.
- j) Connect the 2 air cleaner clamps.

19. BLEED BRAKE LINES

[BRAKE BLEEDING RM LINK](#)

20. ADD ENGINE COOLANT

[ENGINE COOLANT RM LINK](#)

21. CHARGE A/C SYSTEM

[A/C CHARGE RM LINK](#)

22. PROCEED TO SECTION X: FINAL VEHICLE CHECK

VIII. ENGINE ROOM MAIN WIRE HARNESS REPLACEMENT

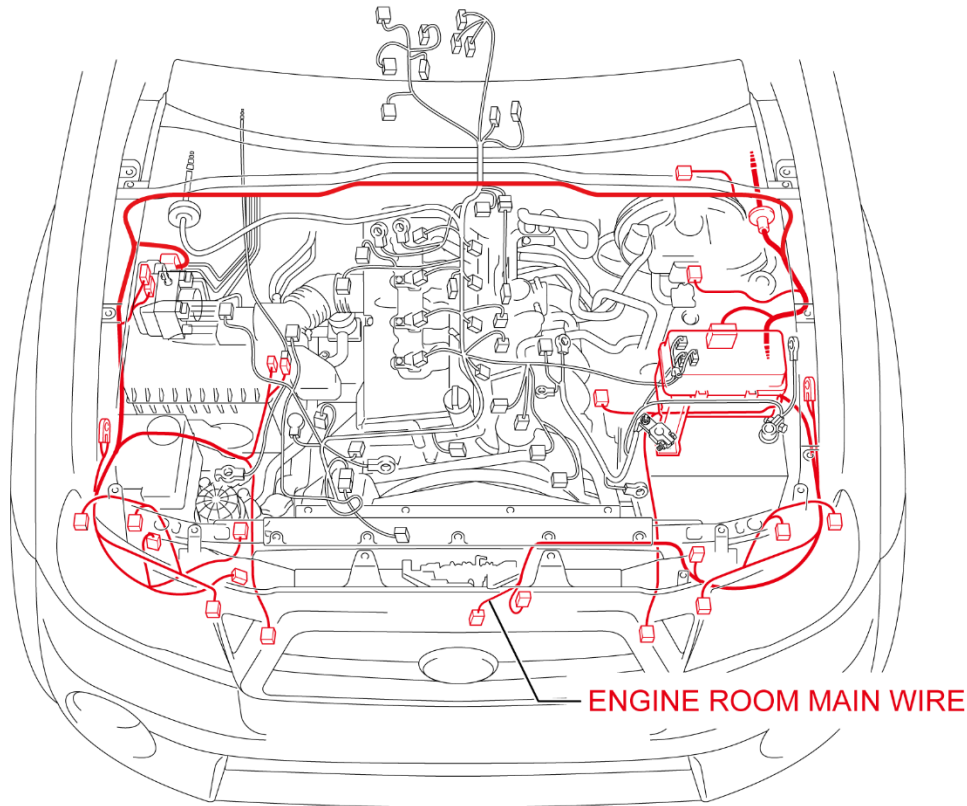

S58006aS

COMPONENTS TO BE REPLACED/REMOVED OVERVIEW

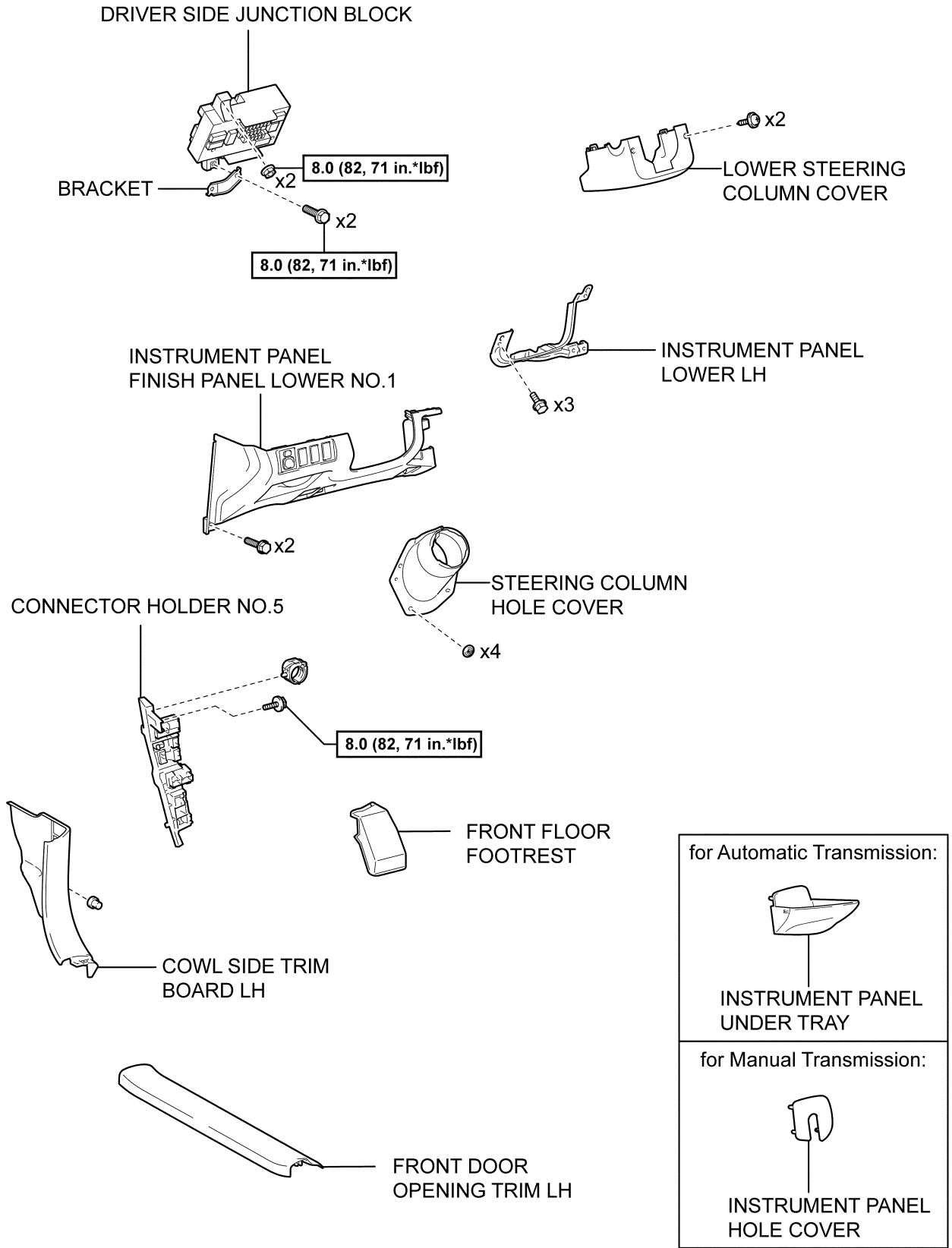

N*m (kgf*cm, ft.*lbf) : Specified torque

S58027aS

COMPONENTS TO BE REPLACED/REMOVED OVERVIEW CONTINUED...

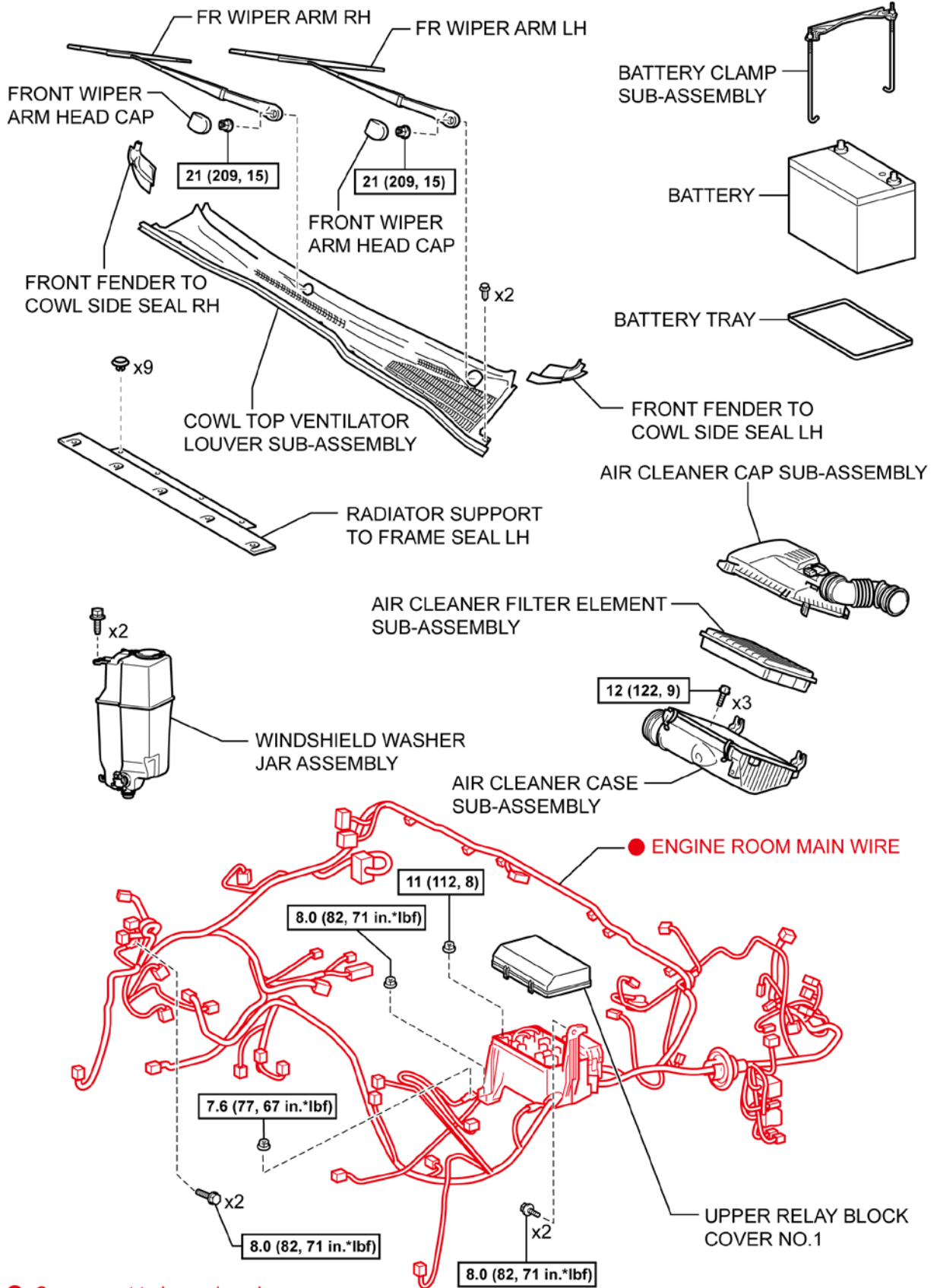

● :Component to be replaced

N*m (kgf*cm, ft.*lbf) : Specified torque

S58026bs



- Always use caution when working in the engine bay because many sharp edges are exposed.
- The following procedure is intended to help guide you, main harness configurations may vary based on vehicle options.
- Use the repair manual links to help with the detailed procedure for certain component removal.

A. ENGINE ROOM MAIN WIRE HARNESS REPLACEMENT

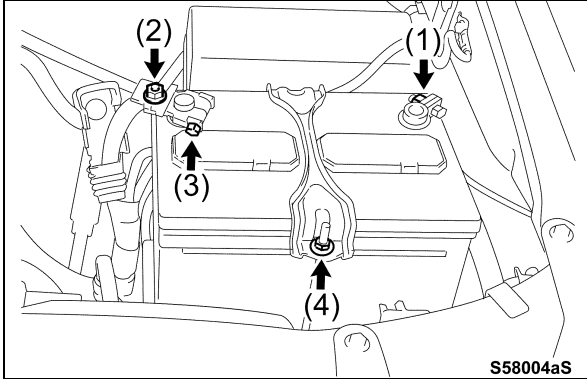

1. REMOVE BATTERY

- Disconnect both the negative and positive battery cables.
- Remove the nut and battery securing bracket.
- Remove battery assembly.

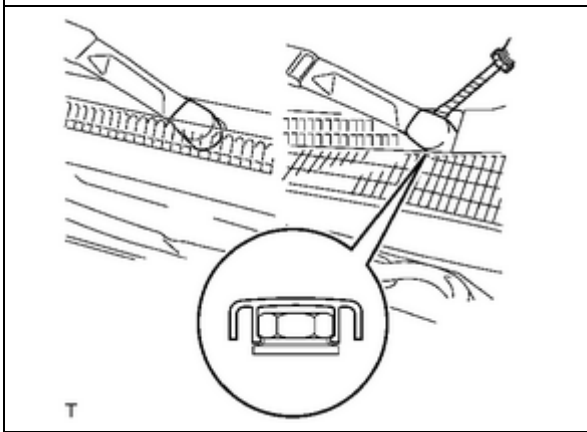

2. REMOVE THE WINDSHIELD WIPER ARMS

- Confirm that the wiper arms are at the auto stop location.
- Remove the 2 windshield wiper arm caps with a screwdriver wrapped in protective tape.

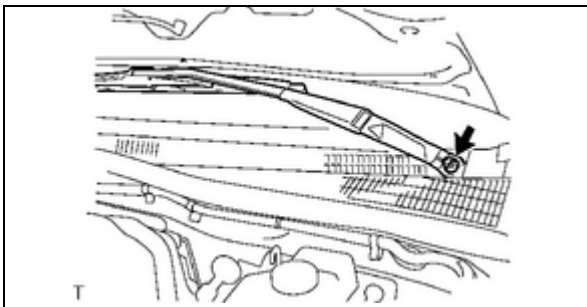

- Remove the nuts and wiper arms.

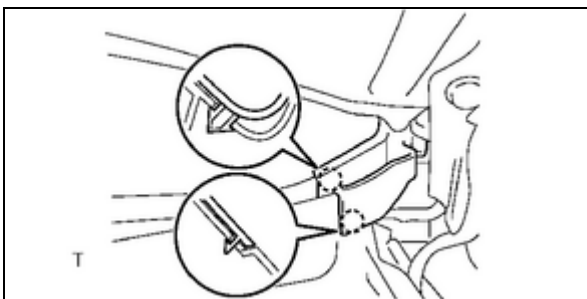

3. REMOVE COWL TOP VENTILATOR LOUVER

- Remove the RH and LH side front fender to cowl seal by disengaging the 2 claws as shown.

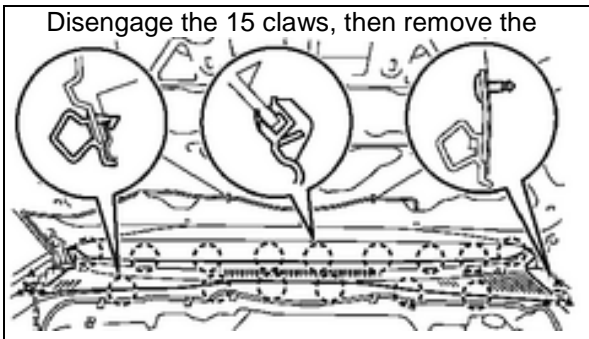

- b) Disengage the 2 clips on the cowl top ventilation louver.
- c) Remove the cowl top ventilator louver.

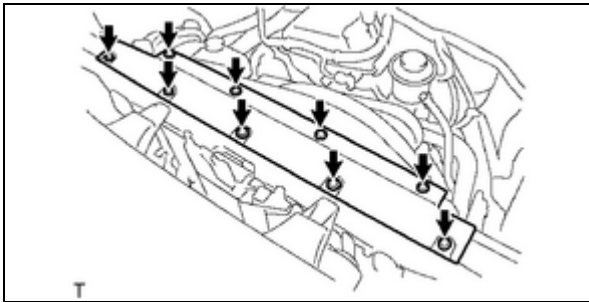

4. REMOVE RADIATOR SUPPORT TO FRAME SEAL LH

- a) Disengage the 9 clips and remove.

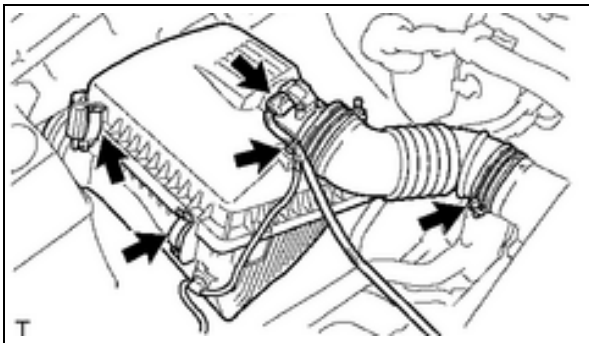

5. REMOVE AIR CLEANER

- a) Disconnect the mass air flow meter connector.
- b) Disconnect the wire harness clamp.
- c) Loosen the hose clamp bolt, then disconnect the air cleaner hose No. 1.
- d) Disconnect the 2 air cleaner clamps.
- e) Remove the air cleaner cap together with the air cleaner hose No. 1.
- f) Remove filter element.
- g) Remove the 3 bolts and air cleaner base.

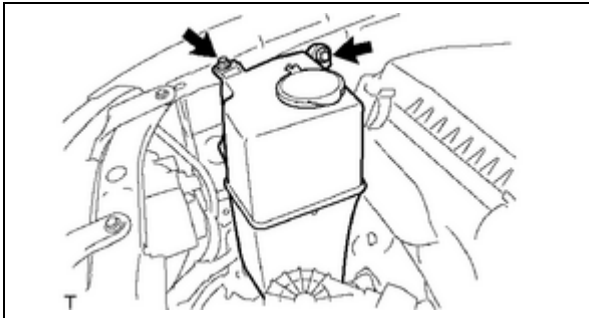

6. SEPARATE WINDSHIELD WASHER JAR

- c) Remove the 2 bolts and remove the windshield washer jar.

7. DISCONNECT ENGINE ROOM MAIN WIRE HARNESS

a) Disconnect the connectors and disengage the clamps as shown in the following illustrations.



- Exact wire harness configuration can vary based upon vehicle options, use the following pages as a guide when disconnecting the harness.
- The vehicle engine bay is broken up into 4 quadrants for your reference.
- Use the following pages as a check sheet to ensure you remove all connectors and clamps.

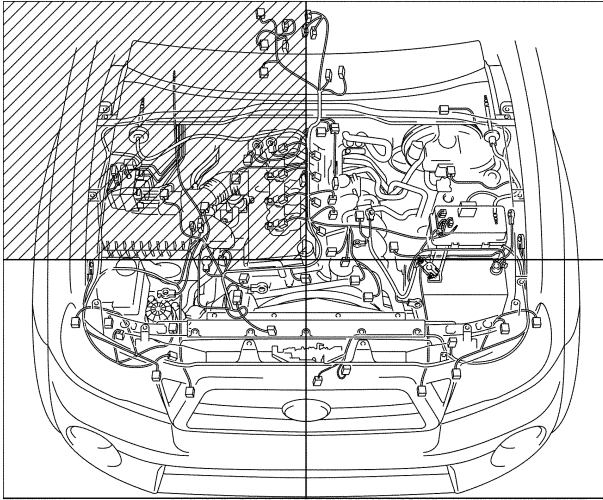

A1: Brake Actuator Assembly
A2: Air Injection Control Driver
A3: Skid Control Sensor Wire
A4: Frame Wire No.1

*1: 10,11MY

*2: From 12MY

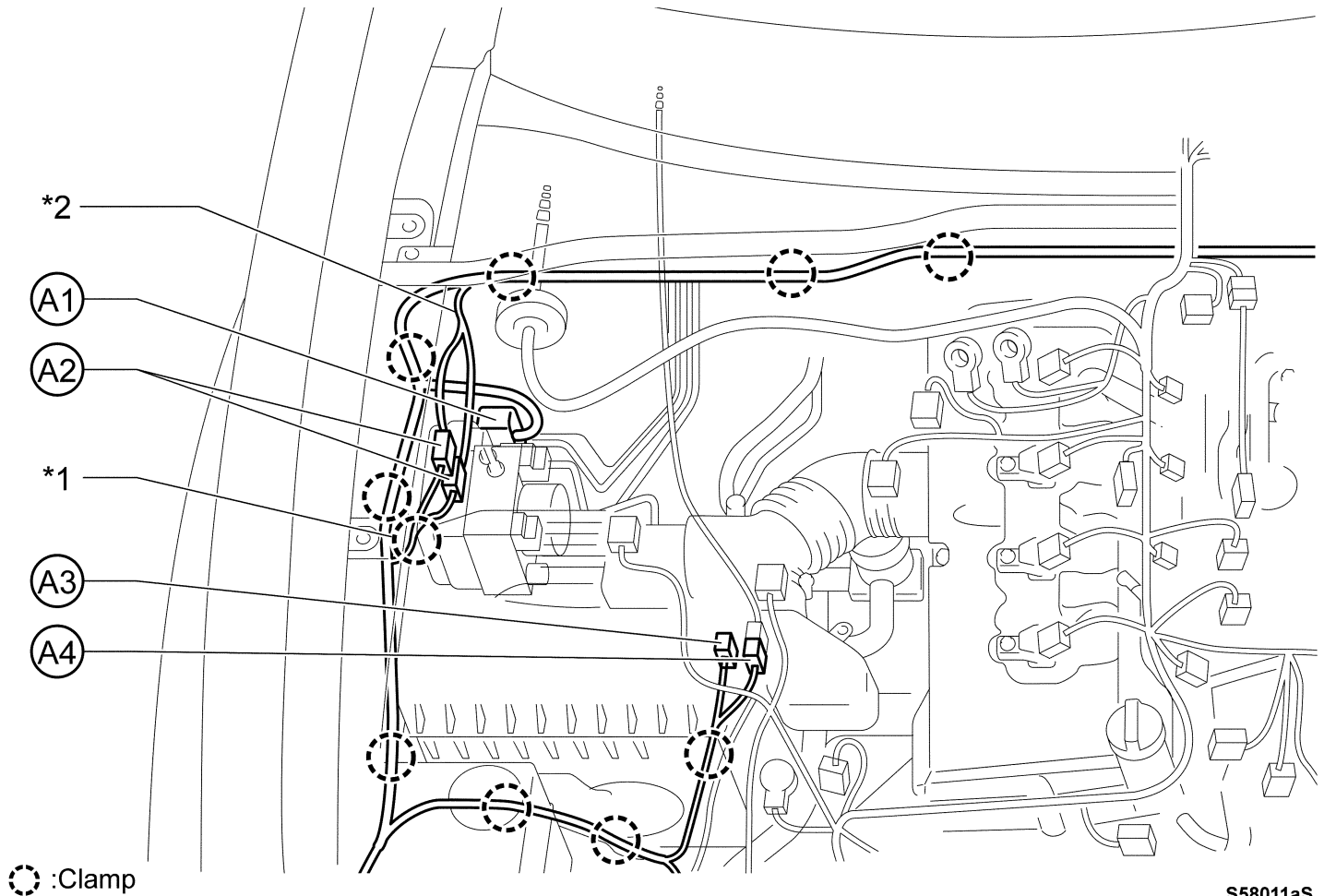

S58011aS

b) Disconnect the connectors and disengage the clamps as shown in the following illustrations.



- Exact wire harness configuration can vary based on vehicle options, use the following pages as a guide when disconnecting the harness.
- The vehicle engine bay is broken up into 4 quadrants for your reference.
- Use the following pages as a check sheet to ensure you remove all connectors and clamps.

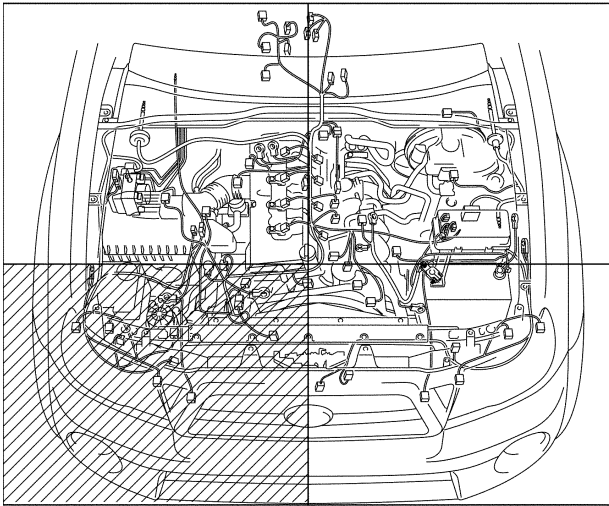

- B1: Body Ground
- B2: Clearance Lamp
- B3: Headlamp
- B4: Windshield Washer Motor and Pump Assembly
- B5: Air Pump Assembly
- B6: Pressure Switch No.1
- B7: Front Turn Signal Lamp
- B8: Front Airbag Sensor RH

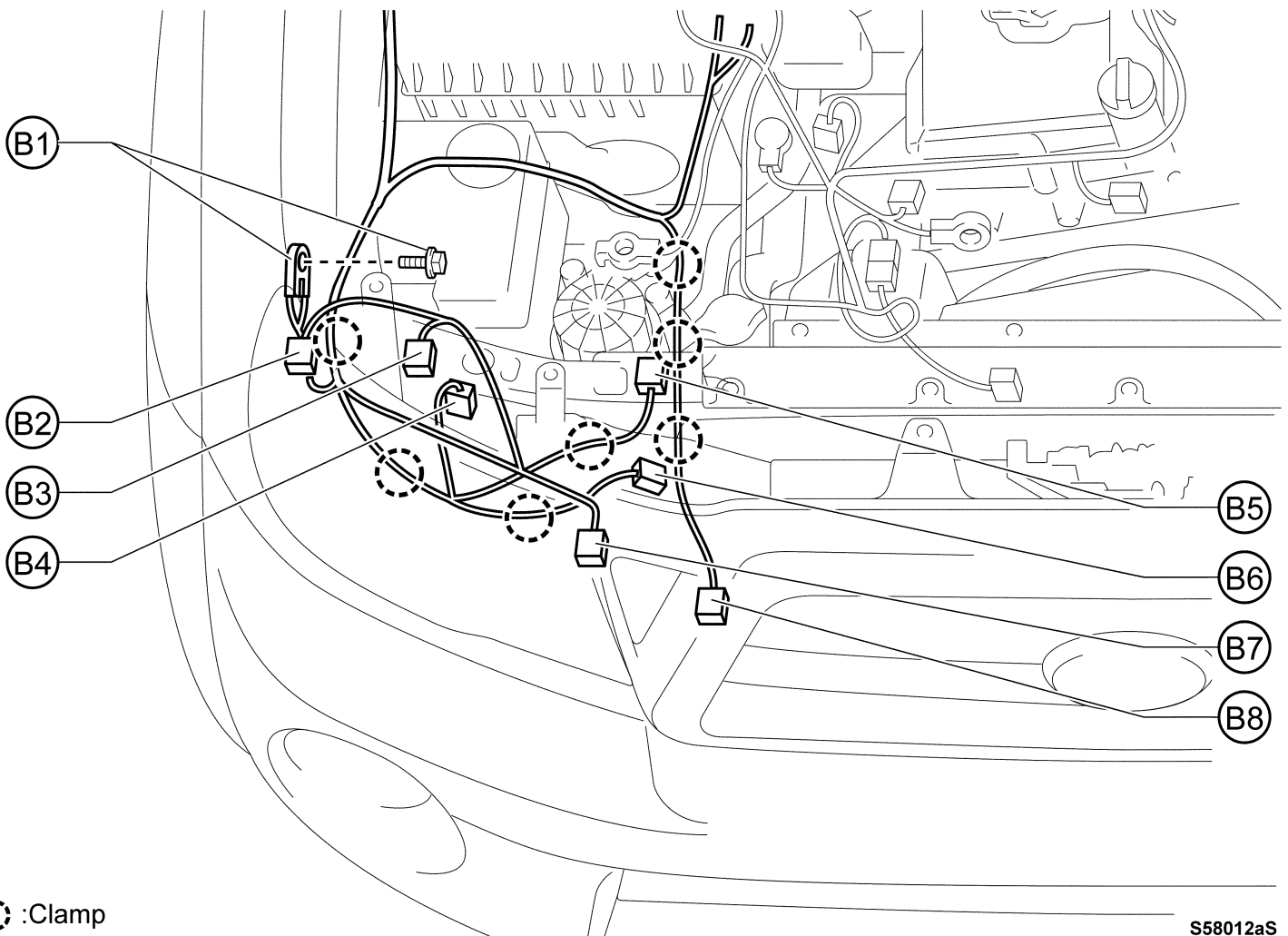

:Clamp

S58012aS

- c) Disconnect the connectors and disengage the clamps as shown in the following illustrations.
- d) Remove the body ground bolt.



- Exact wire harness configuration can vary based on vehicle options, use the following pages as a guide when disconnecting the harness.
- The vehicle engine bay is broken up into 4 quadrants for your reference.
- Use the following pages as a check sheet to ensure you remove all connectors and clamps.

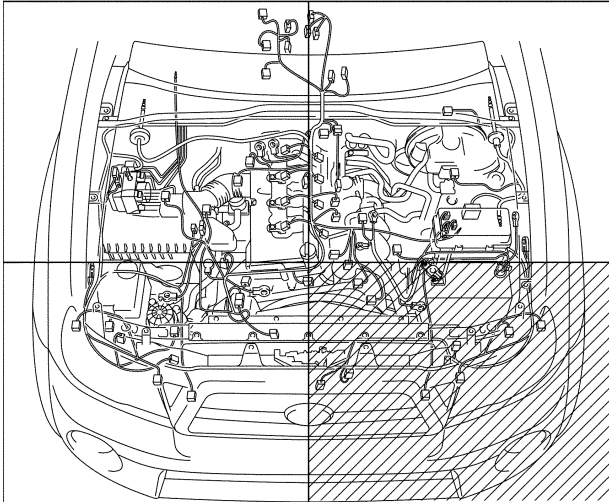

- C1: Skid Control Sensor Wire
- C2: Low Pitched Horn Assembly
- C3: Cooler Thermistor (Ambient Temperature Sensor)
- C4: Body Ground
- C5: Clearance Lamp
- C6: Headlamp
- C7: Wireless Door Lock Buzzer
- C8: Front Turn Signal Lamp
- C9: Front Airbag Sensor LH

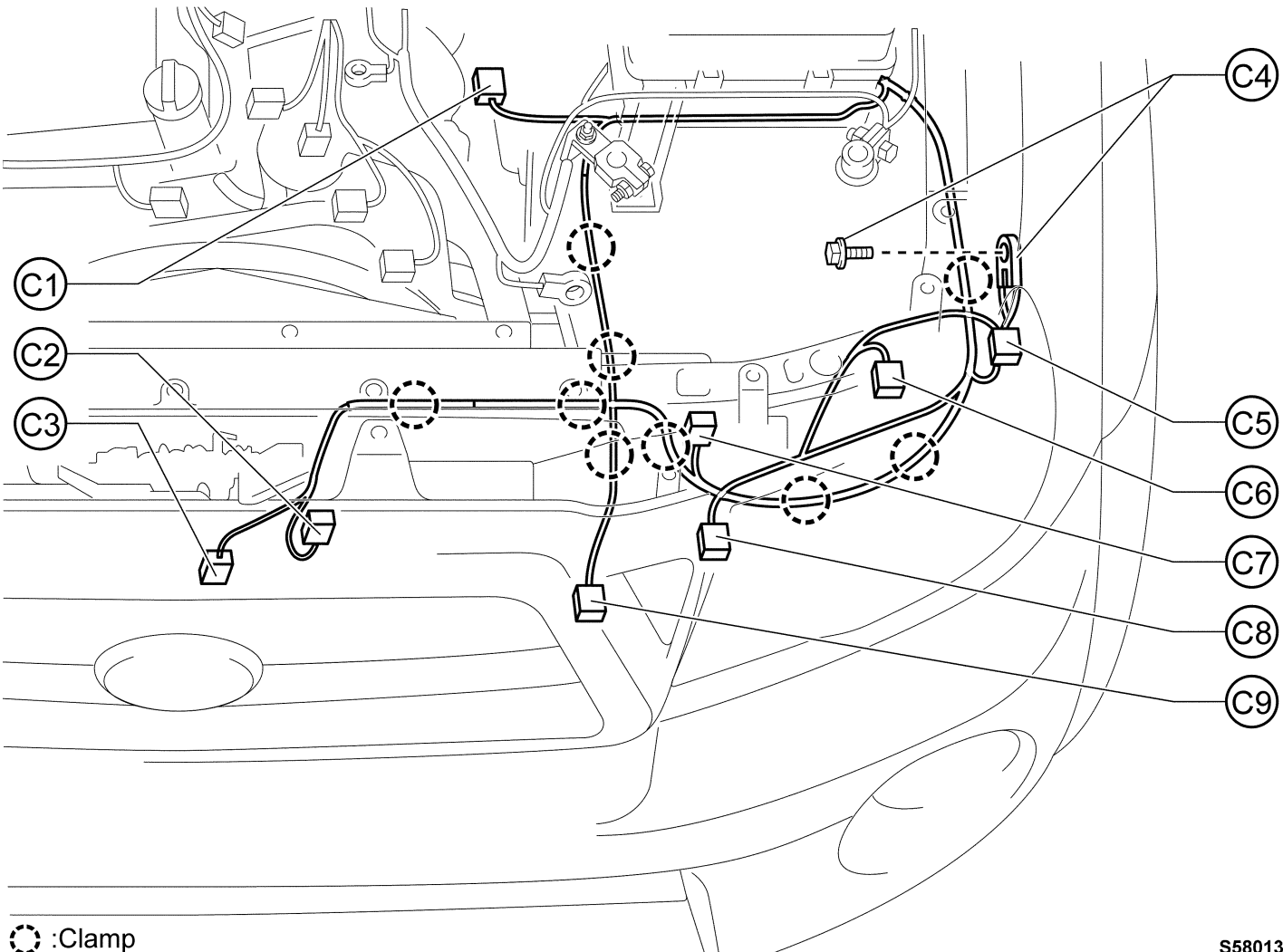

S58013aS

- e) Remove the upper relay block cover No.1.
- f) Disconnect the connectors and disengage the clamps as shown in the following illustrations.
- g) Remove the 2 bolts and the 2 nuts.



- Exact wire harness configuration can vary based on vehicle options, use the following pages as a guide when disconnecting the harness.
- The vehicle engine bay is broken up into 4 quadrants for your reference.
- Use the following pages as a check sheet to ensure you remove all connectors and clamps.

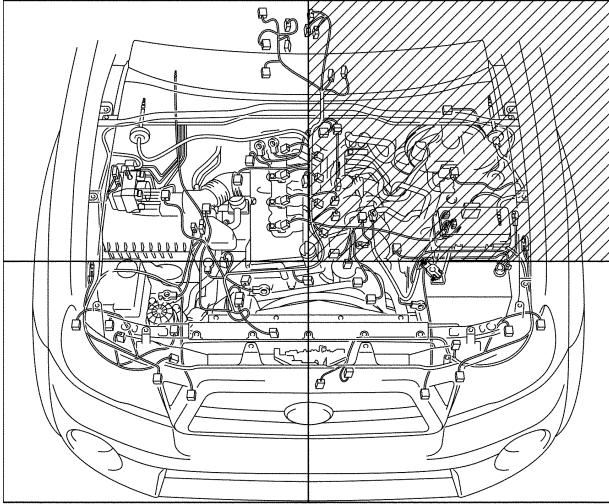

- D1: Windshield Wiper Motor Assembly
- D2: Brake Master Cylinder Reservoir Sub-Assembly
- D3: Bolt
- D4: Nut
- D5: Nut

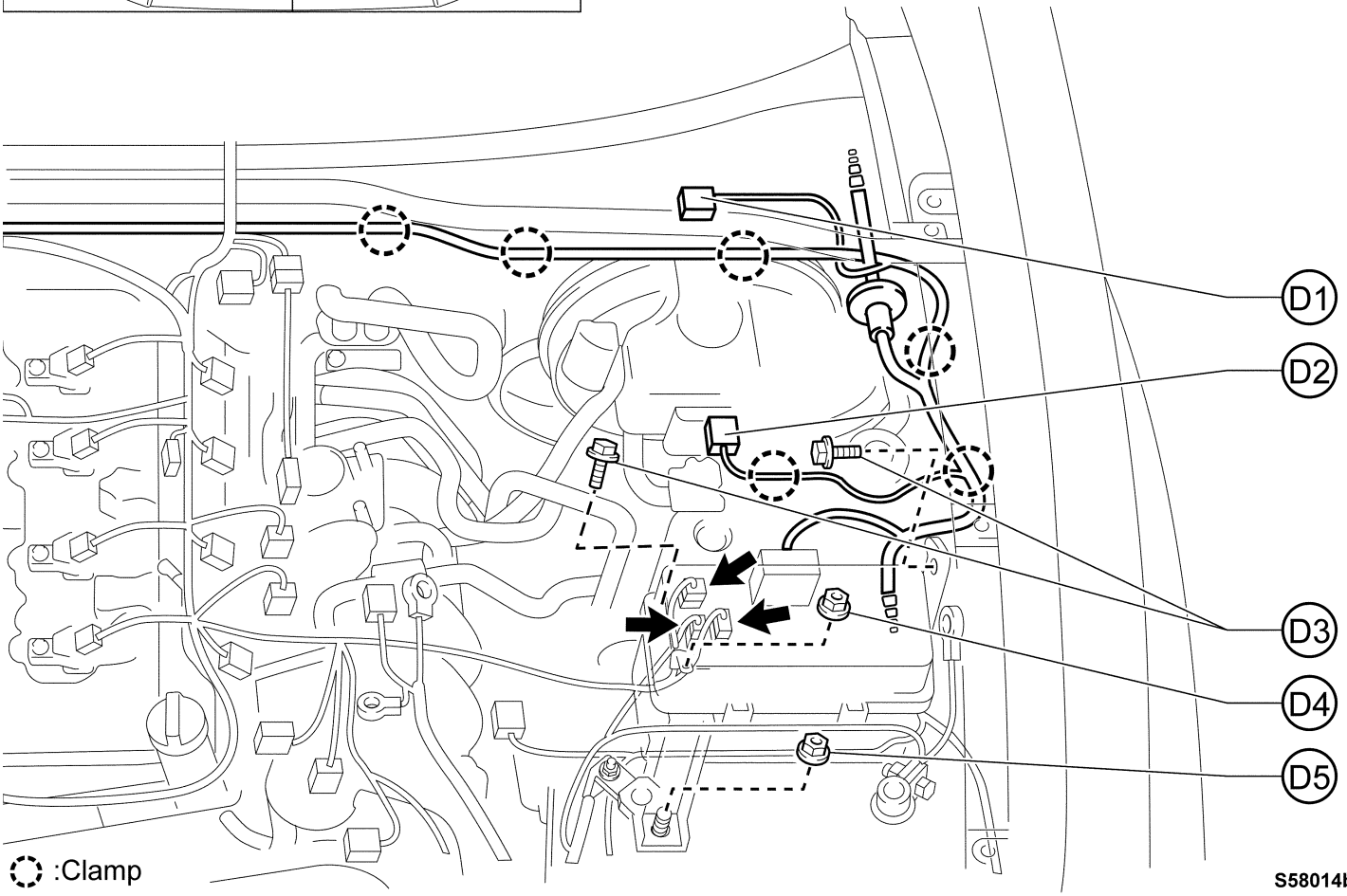

S58014bS

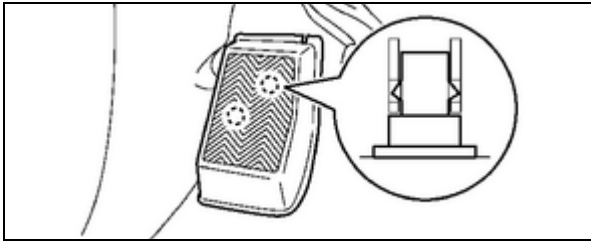

8. REMOVE THE FRONT FLOOR FOOT REST

- a) Disengage the 2 clips.

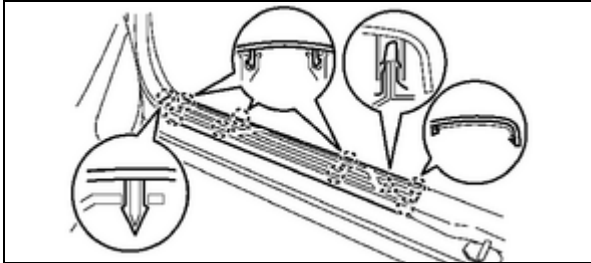

9. REMOVE FRONT DOOR SCUFF PLATE

- a) Disengage the 9 claws and remove.

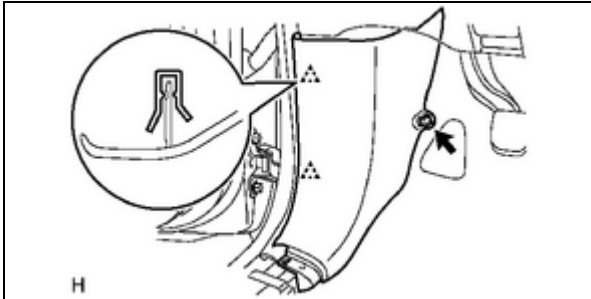

10. REMOVE COWL SIDE TRIM BOARD LH

- a) Remove the clip.
- b) Disengage the 2 clips and remove.

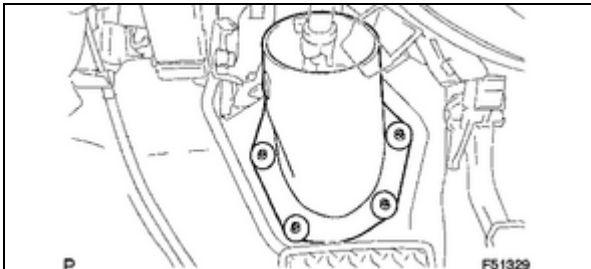

11. REMOVE STEERING COLUMN HOLE COVER

- a) Disengage the 2 clips and remove.

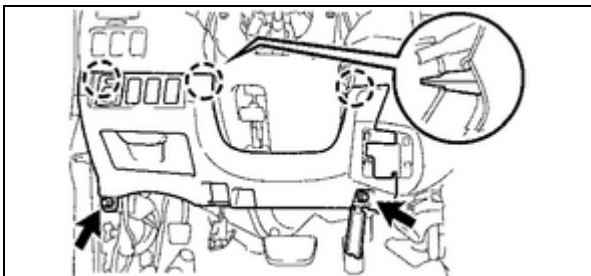

12. REMOVE INSTRUMENT PANEL LOWER FINISH PANEL NO.1

- a) Remove the 2 bolts.
- b) Disengage the 3 clips and carefully remove.
- c) Disconnect the electrical connectors.

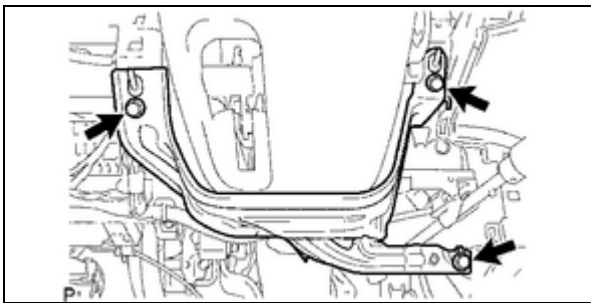

13. REMOVE INSTRUMENT PANEL LOWER LH

- a) Remove the 3 bolts and remove the panel.

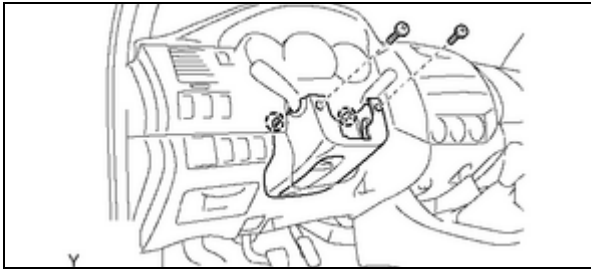

14. REMOVE LOWER STEERING COLUMN COVER.

- a) Remove the 2 screws.

Note: To access the screws you may need to turn the steering wheel.

- b) Disengage the 2 clips and remove.

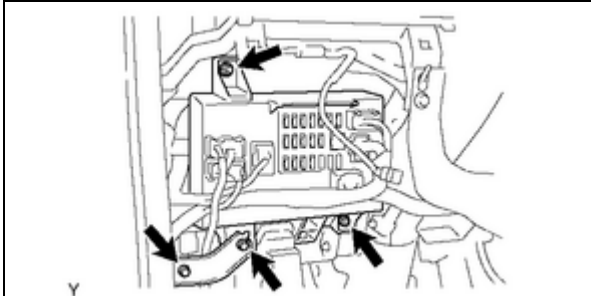

15. REMOVE DRIVER SIDE JUNCTION BLOCK

- a) Remove the 2 bolts and bracket.
- b) Remove the 2 nuts and separate the driver side junction block.

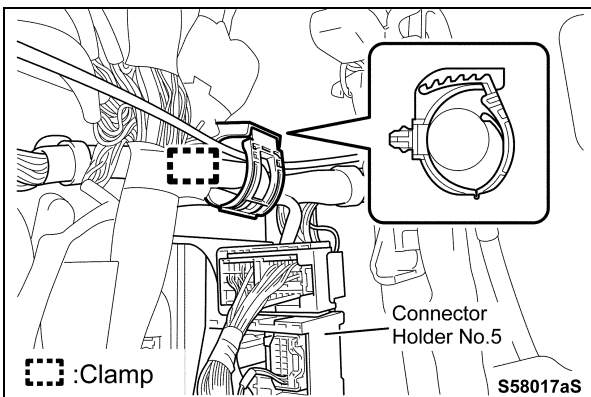

16. REMOVE THE ENGINE ROOM MAIN HARNESS

- a) Disengage the clamp from the connector holder No. 5.

- b) Disconnect the 5 front connectors from the connector holder No. 5.

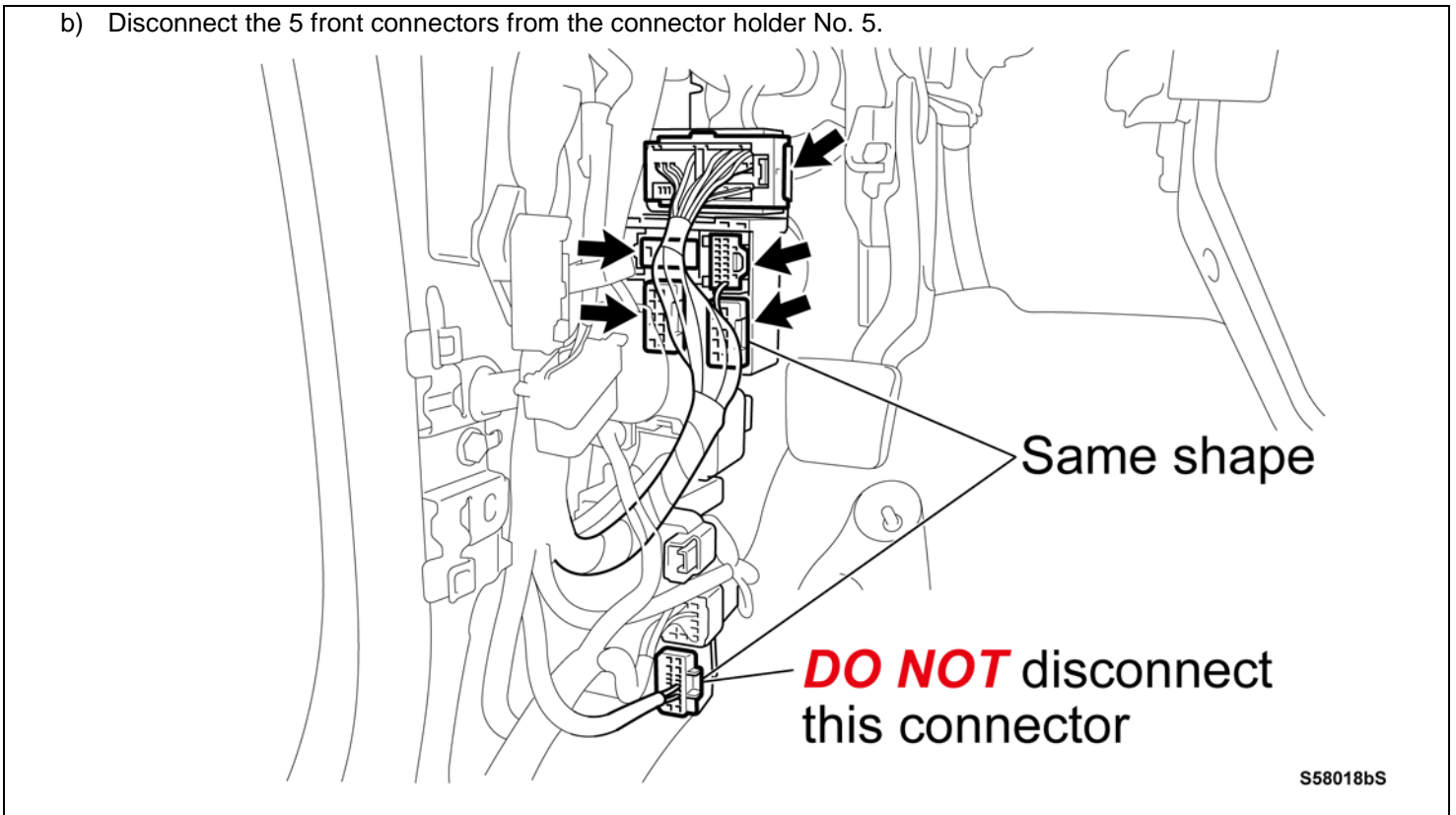

c) Remove the bolt and clamp to unfasten the connector holder No. 5

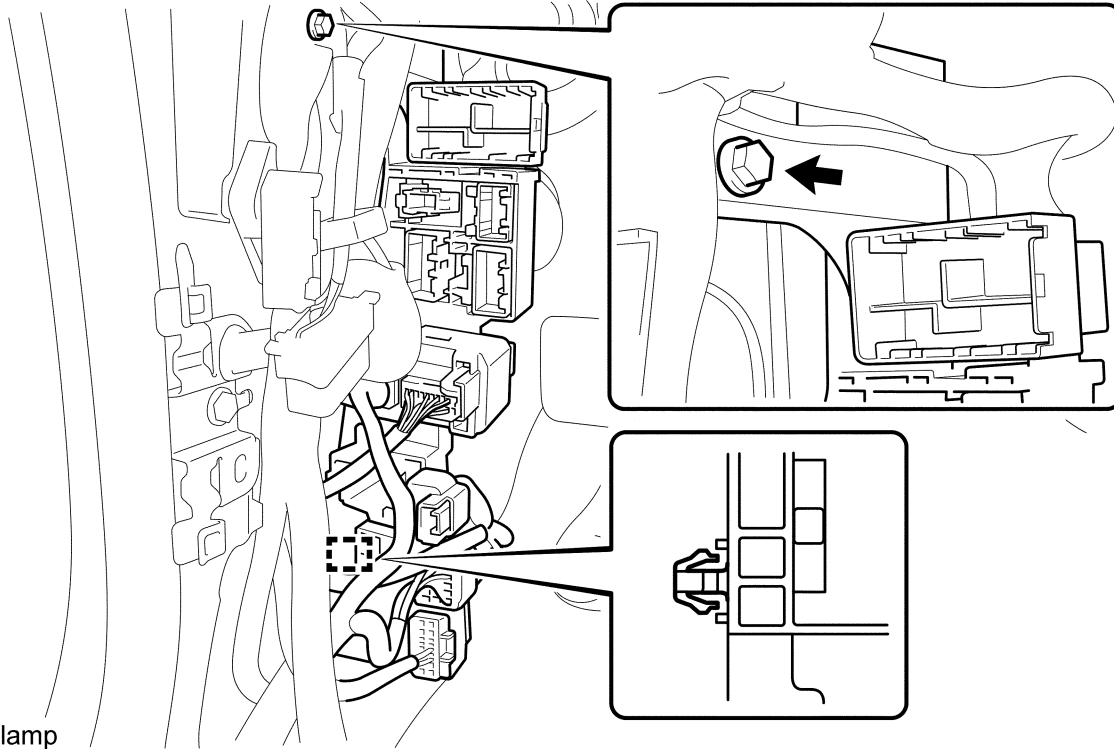

 :Clamp

S58019aS

d) Disconnect the 5 female connectors and 2 male connectors that are located at the back of the connector holder No. 5.

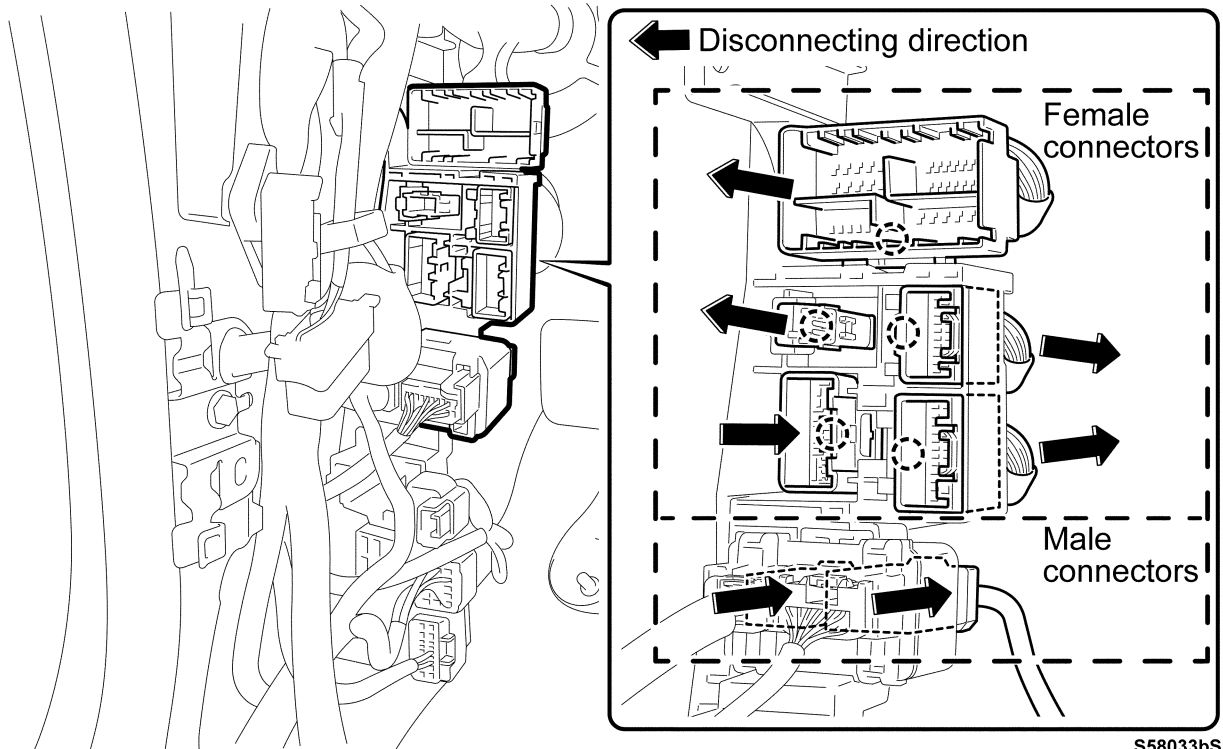

S58033bS

e) Disconnect the 5 female connectors and disengage the clamps located in the foot pedal area as shown.

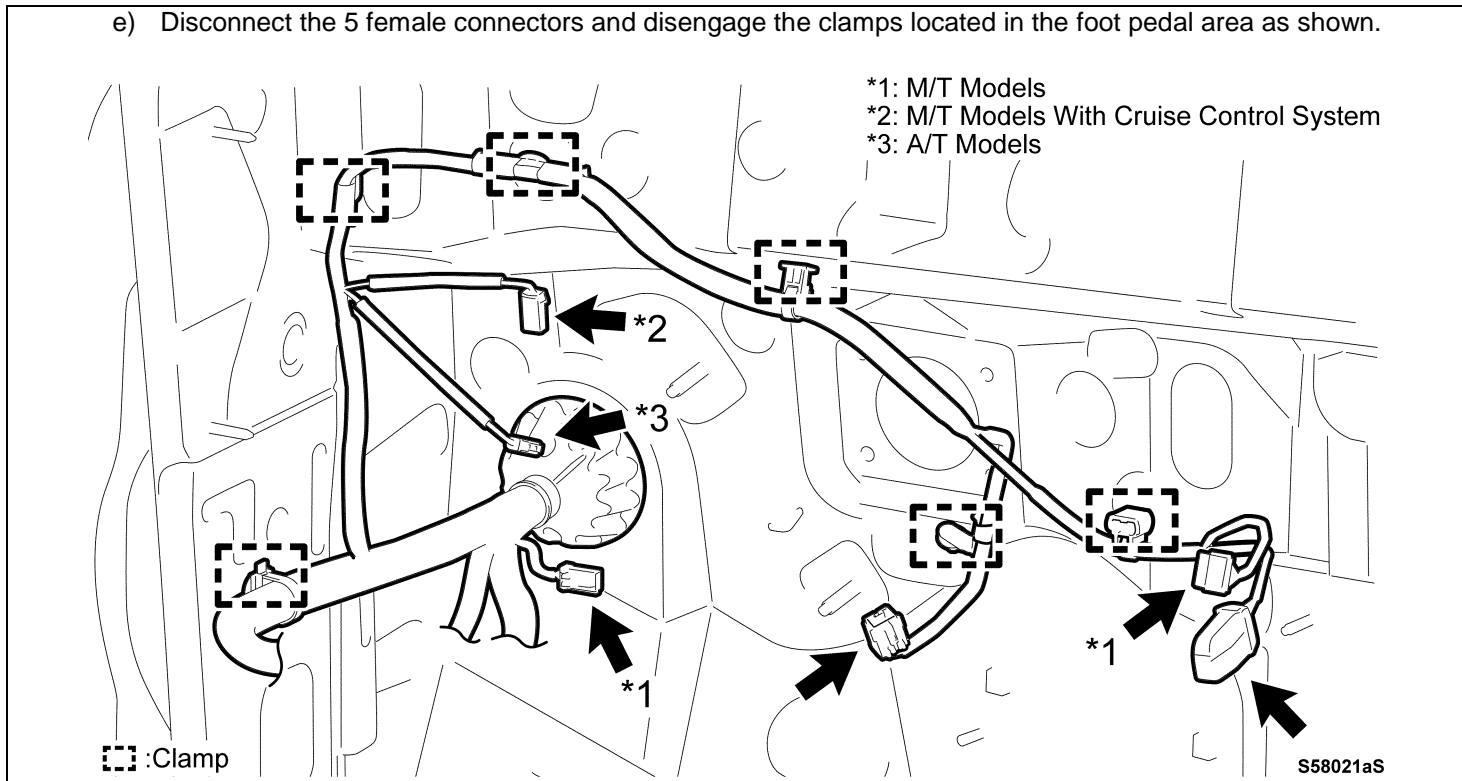

- f) Confirm all connectors and clamps have been disconnected.
- g) Pull out the engine room main harness from the vehicle cabin towards the engine compartment as shown.
- h) Pull out the hood lock cable from the wire harness grommet.
- i) Mark the removed harness so that it is not reused.

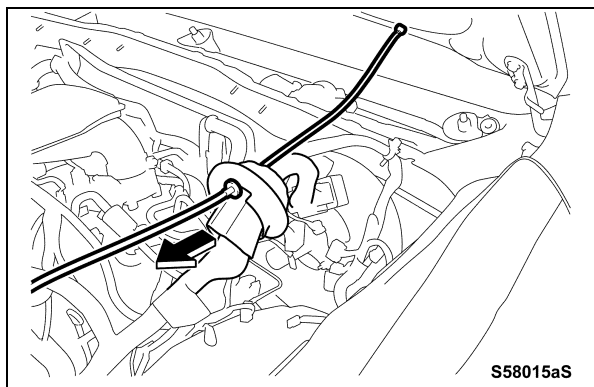

B. INSTALL **NEW** ENGINE ROOM MAIN HARNESS

1. INSTALL ENGINE ROOM MAIN HARNESS INTO THE VEHICLE CABIN

- a) Insert the hood lock cable into the harness grommet.
- b) Insert the engine room main harness from the engine room into the vehicle cabin as shown.

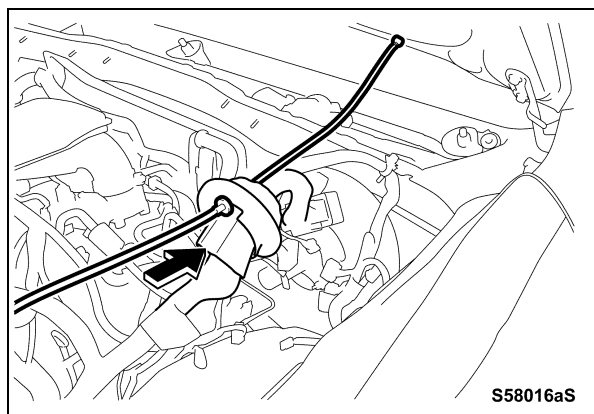

c) Connect the 5 female connectors and engage the clamps located in the foot pedal area as shown.

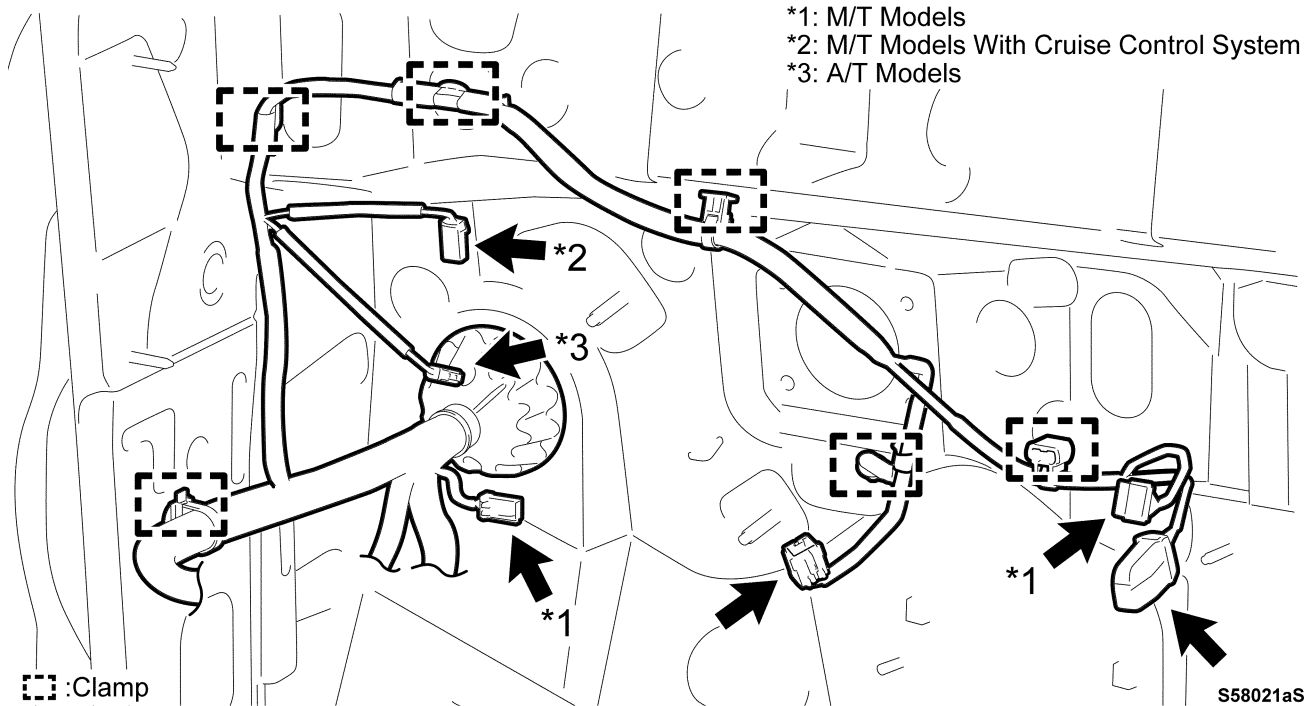

d) Connect the 5 female connectors and 2 male connectors that are located at the back of the connector holder No. 5.

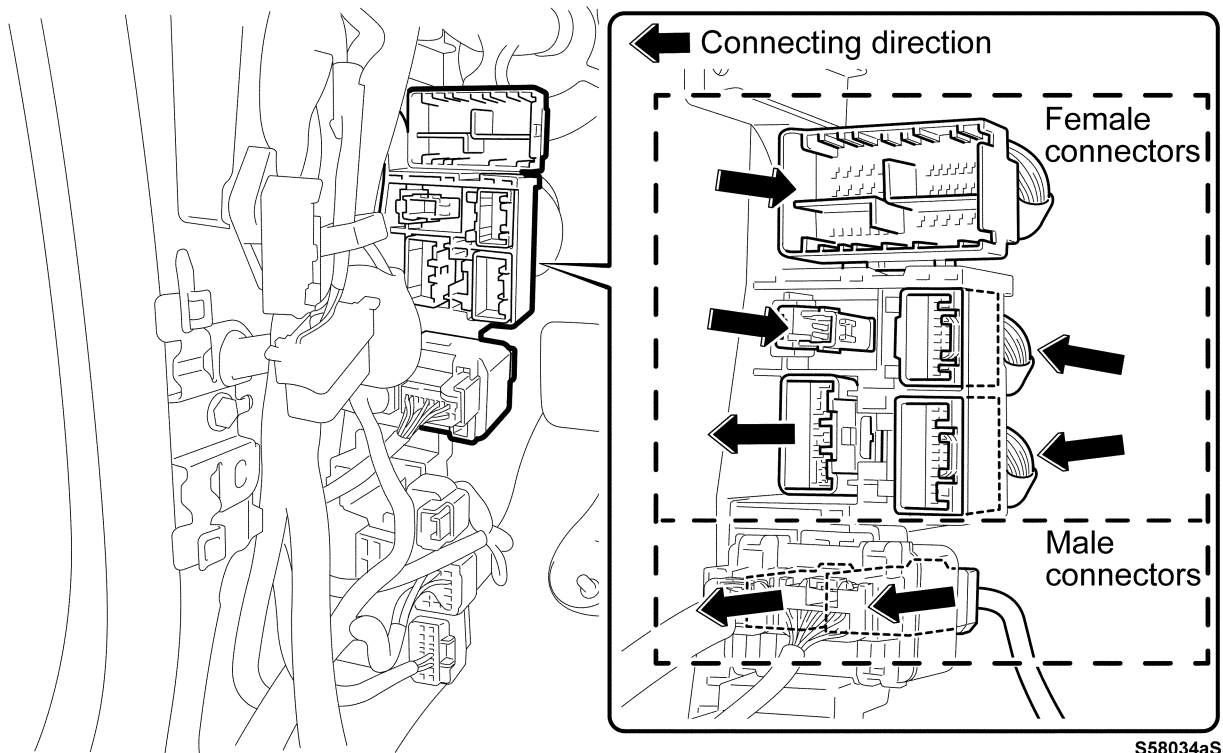

e) Fasten the connector holder No. 5 with the bolt.

Torque Spec: 8.0Nm (82 kgf-cm, 71 in-lbf)

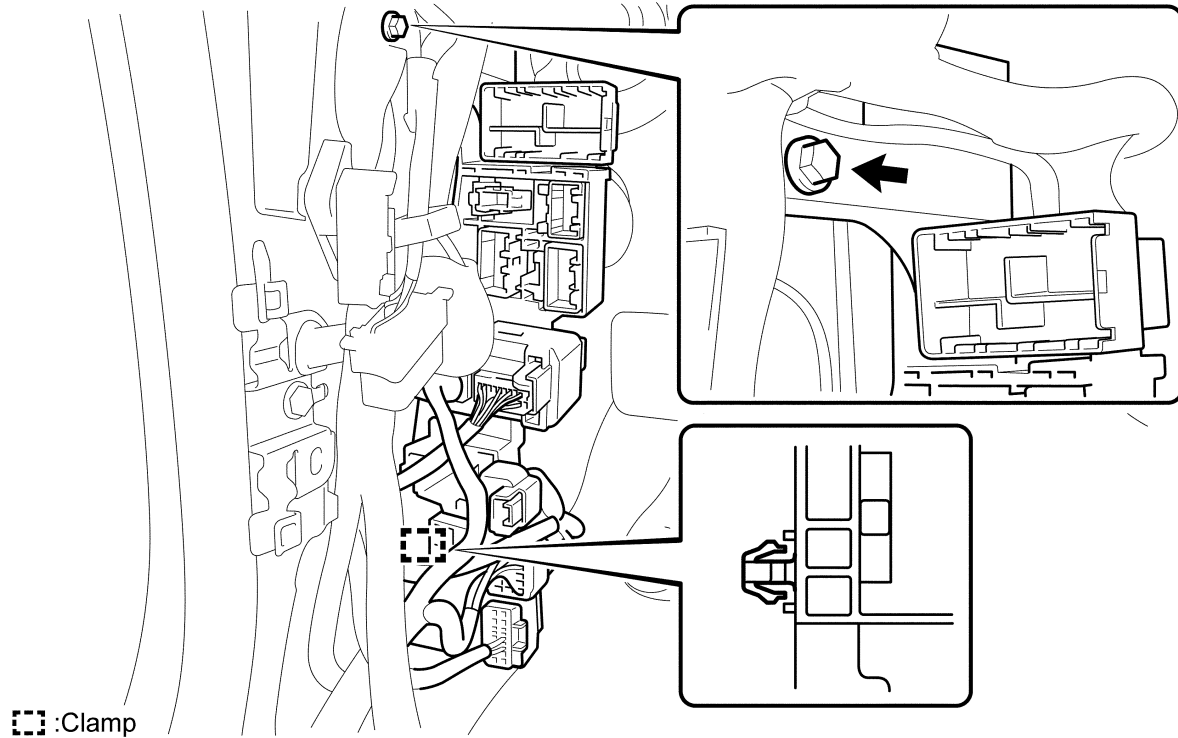

S58019aS

f) Connect the 5 connectors to the connector holder No. 5.

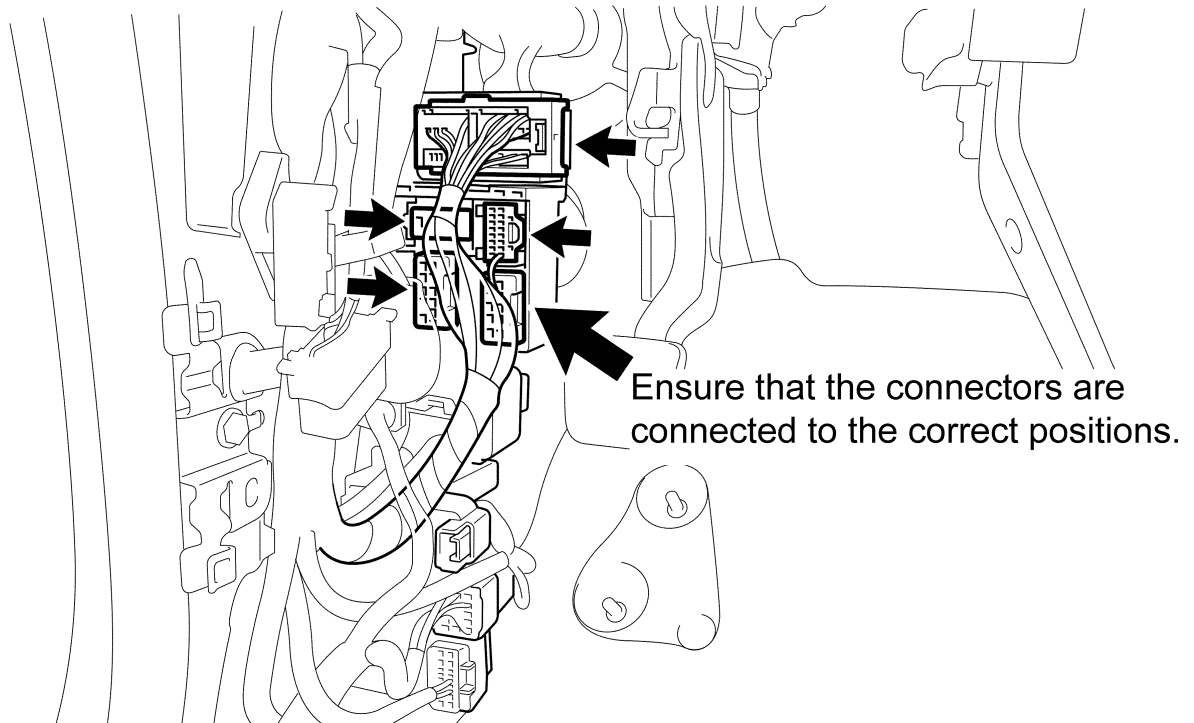

g) Engage the clamp to the connector holder No. 5.

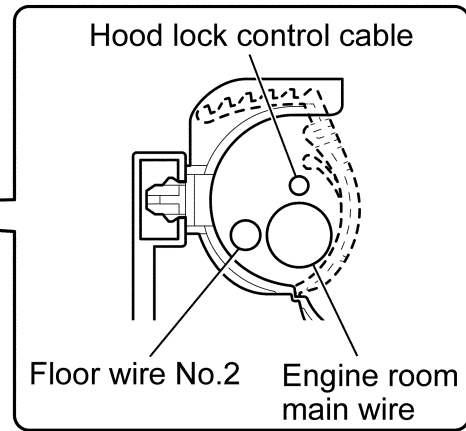
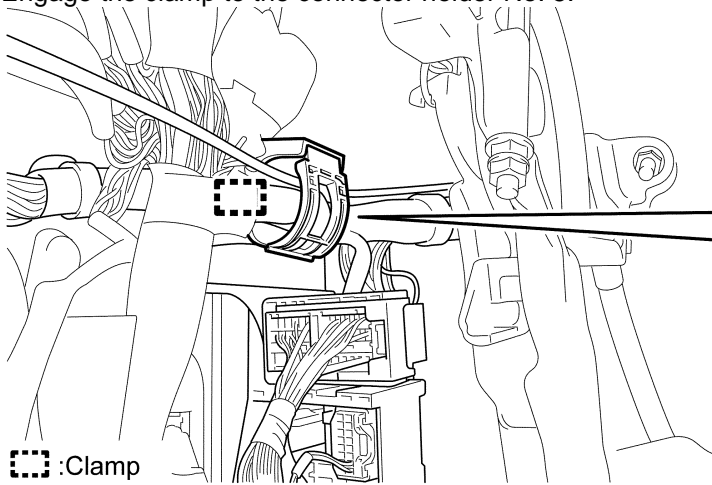

S58022aS

2. REINSTALL DRIVER'S SIDE JUNCTION BLOCK

a) Install the junction block with the 2 nuts.

Torque Spec: 8.0Nm (82 kgf-cm, 71 in-lbf)

b) Install the bracket with the 2 bolts.

Torque Spec: 8.0Nm (82 kgf-cm, 71 in-lbf)

3. REINSTALL THE LOWER STEERING COLUMN COVER.

a) Engage the 2 claws.

b) Install the 2 screws.

Note: To access the screws you may need to turn the steering wheel.

4. REINSTALL INSTRUMENT PANEL LOWER LH

a) Install the panel with the 3 bolts.

5. REMOVE INSTRUMENT PANEL LOWER FINISH PANEL NO.1

a) Connect the electrical connectors

b) Engage the 3 clips.

c) Install the 3 bolts.

6. REINSTALL THE STEERING COLUMN HOLE COVER

a) Install the hole cover and engaged the 2 clips.

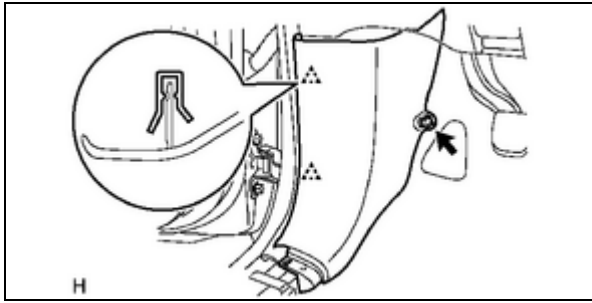

7. REINSTALL COWL SIDE TRIM BOARD LH

- a) Engage the 2 clips.
- b) Install the clip onto the stud.

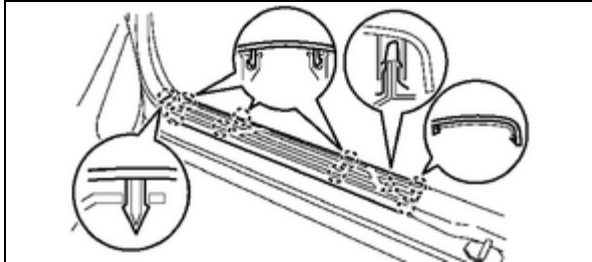

8. REINSTALL FRONT DOOR SCUFF PLATE

- a) Install the scuff plate and engage the 9 claws.

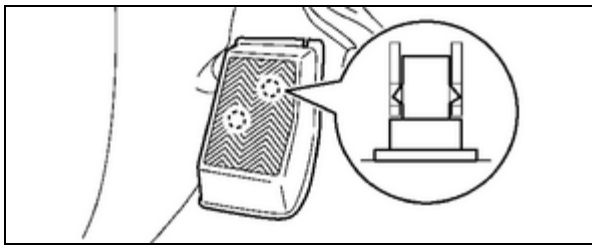

9. REINSTALL THE FRONT FLOOR FOOT REST

- b) Install the foot rest and engage the 2 clips.

10. INSTALL THE *NEW* ENGINE ROOM MAIN HARNESS IN THE ENGINE ROOM

- a) Connect the connectors and engage the clamps as shown.
- b) Reinstall the 2 bolts and nuts

Torque Spec:

D3, D5: 8.0 Nm (82 kgf-cm, 71 in-lbf)

D4: 11.0 Nm (112 kgf-cm, 8 ft-lbf)

- c) Reinstall the relay block cover No. 1



- Exact wire harness configuration can vary based on vehicle options, use the following pages as a guide when connecting the harness.
- The vehicle engine bay is broken up into 4 quadrants for your reference.
- Use the following pages as a check sheet to ensure you connect all connectors and clamps.

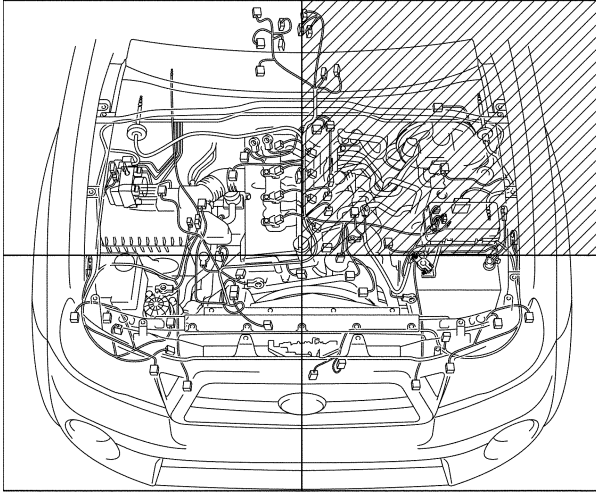

- D1: Windshield Wiper Motor Assembly
- D2: Brake Master Cylinder Reservoir Sub-Assembly
- D3: Bolt
- D4: Nut
- D5: Nut

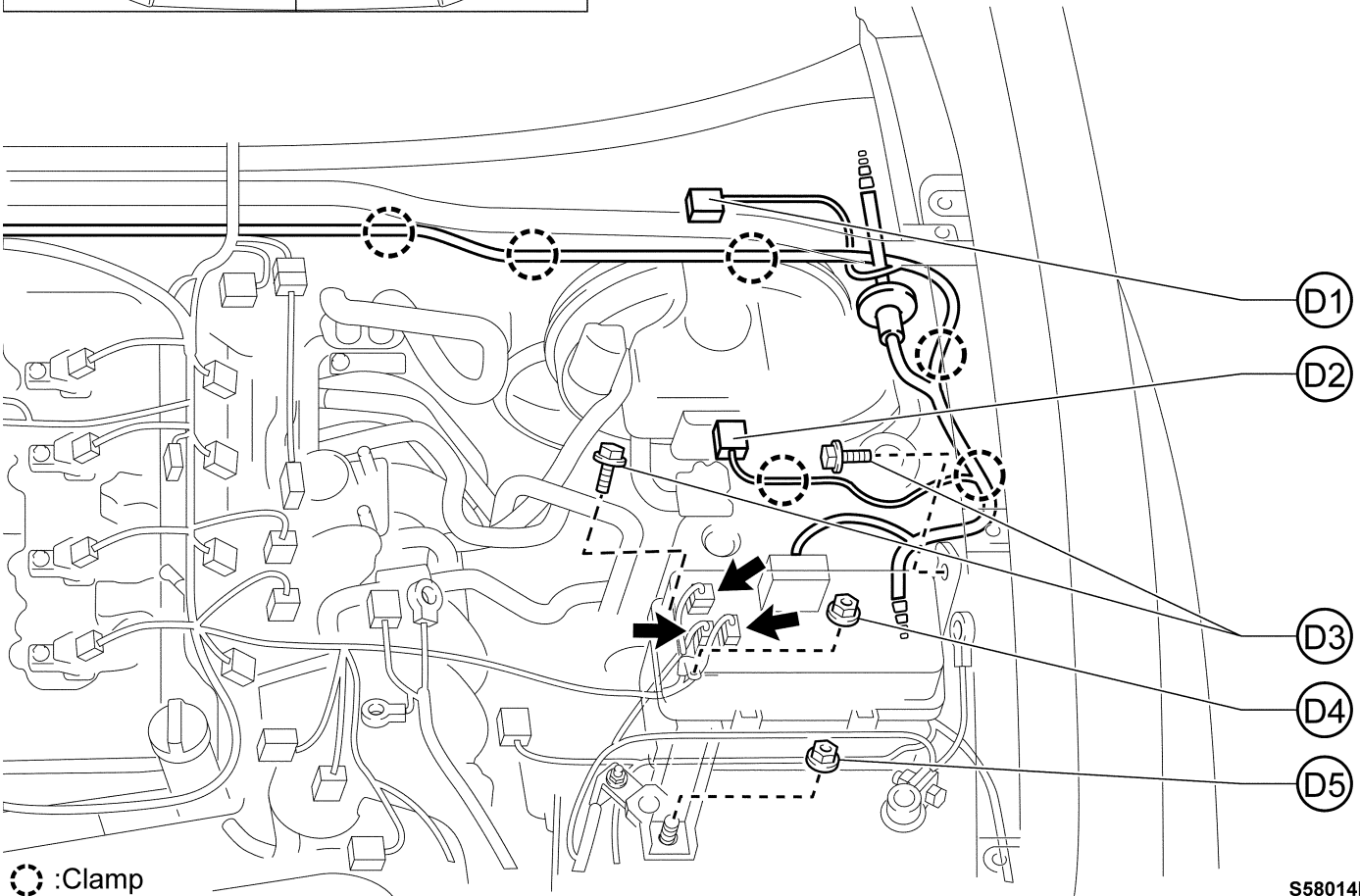

S58014bS

- d) Connect the connectors and engage the clamps as shown.
- e) Reinstall the bolt.

Torque Spec:

C4: 8.0 Nm (82 kgf-cm, 71 in-lbf)



- Exact wire harness configuration can vary based on vehicle options, use the following pages as a guide when connecting the harness.
- The vehicle engine bay is broken up into 4 quadrants for your reference.
- Use the following pages as a check sheet to ensure you connect all connectors and clamps.

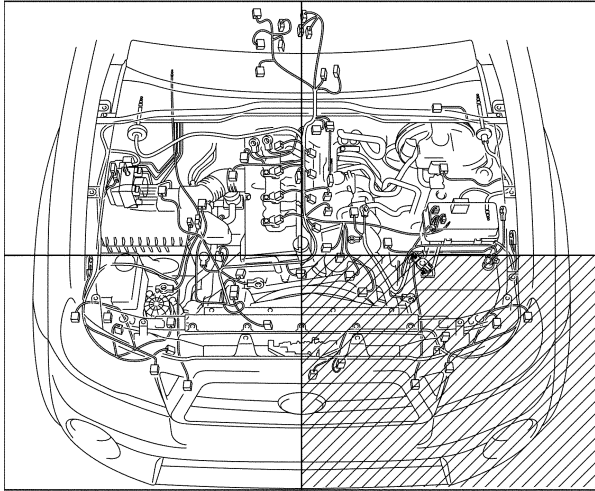

- C1: Skid Control Sensor Wire
- C2: Low Pitched Horn Assembly
- C3: Cooler Thermistor (Ambient Temperature Sensor)
- C4: Body Ground
- C5: Clearance Lamp
- C6: Headlamp
- C7: Wireless Door Lock Buzzer
- C8: Front Turn Signal Lamp
- C9: Front Airbag Sensor LH

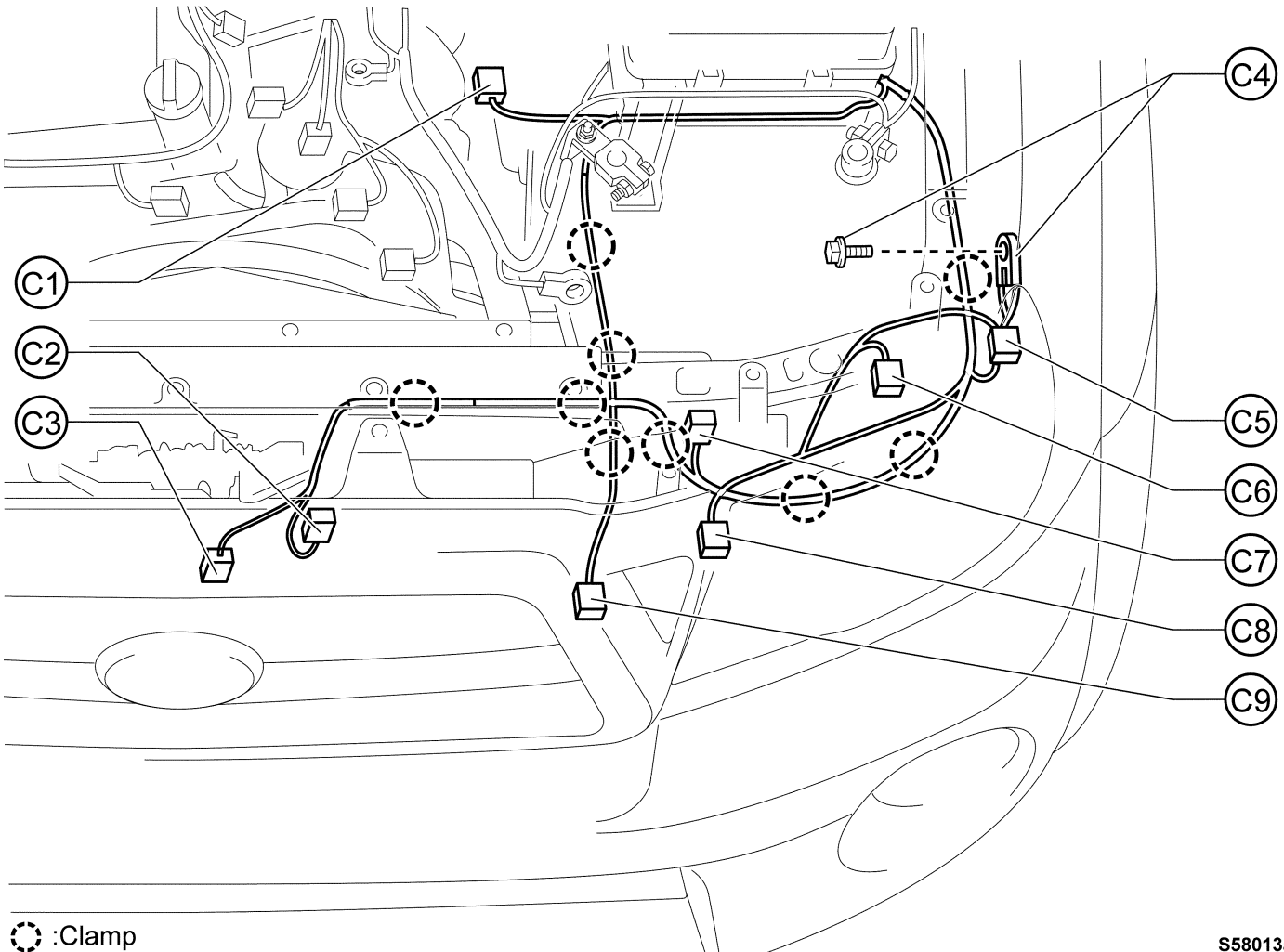

S58013aS

- f) Connect the connectors and engage the clamps as shown.
- g) Reinstall the bolt.

Torque Spec:

B1: 8.0Nm (82 kgf-cm, 71 in-lbf)



- Exact wire harness configuration can vary based on vehicle options, use the following pages as a guide when connecting the harness.
- The vehicle engine bay is broken up into 4 quadrants for your reference.
- Use the following pages as a check sheet to ensure you connect all connectors and clamps.

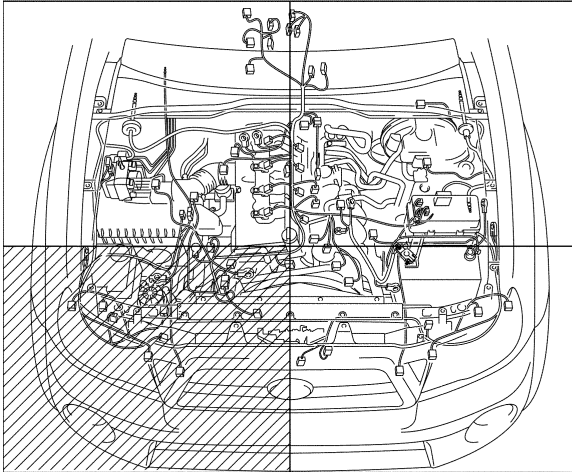

- B1: Body Ground
- B2: Clearance Lamp
- B3: Headlamp
- B4: Windshield Washer Motor and Pump Assembly
- B5: Air Pump Assembly
- B6: Pressure Switch No.1
- B7: Front Turn Signal Lamp
- B8: Front Airbag Sensor RH

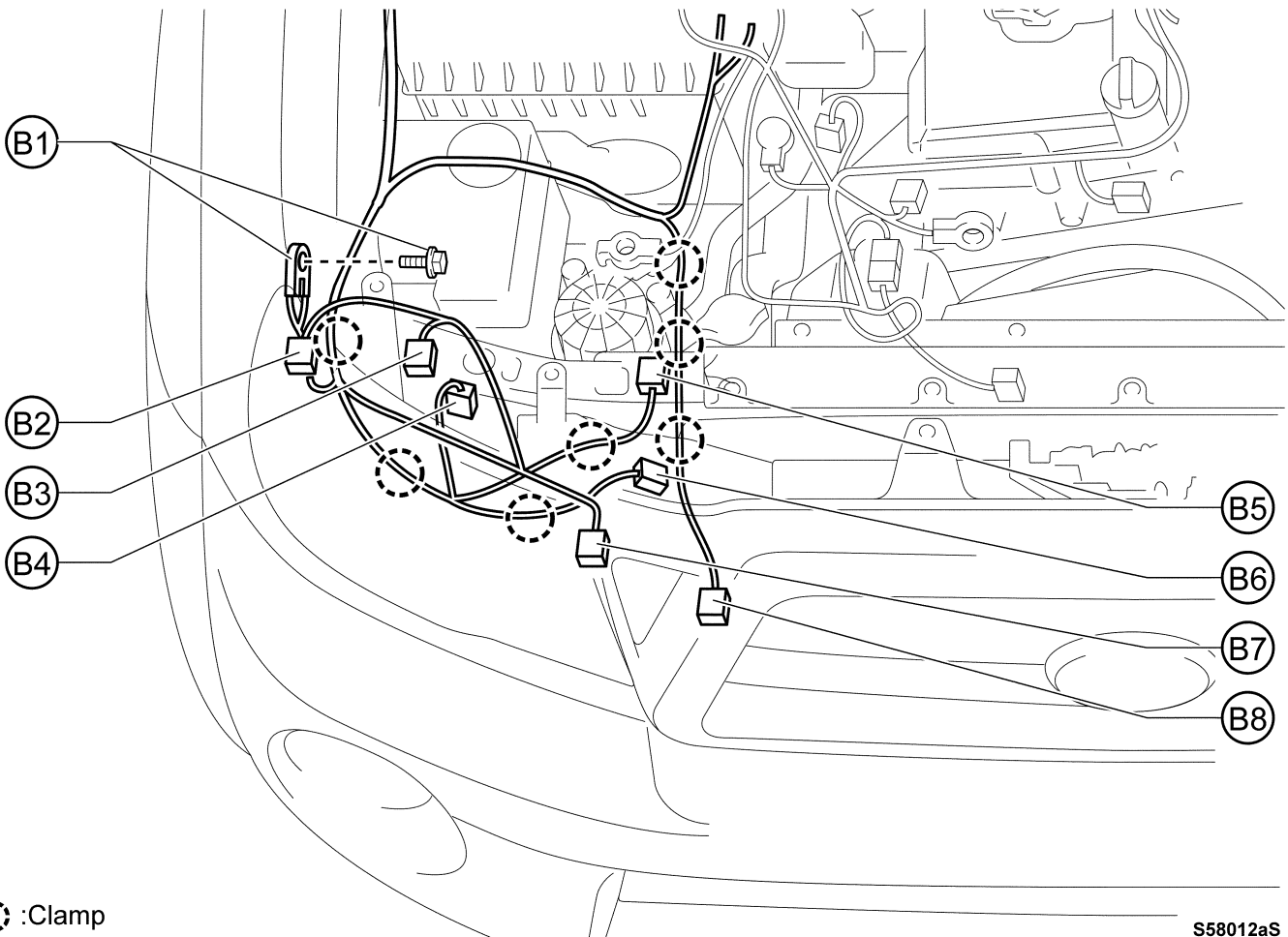

 :Clamp

S58012aS

h) Connect the connectors and engage the clamps as shown.



- Exact wire harness configuration can vary based on vehicle options, use the following pages as a guide when connecting the harness.
- The vehicle engine bay is broken up into 4 quadrants for your reference.
- Use the following pages as a check sheet to ensure you connect all connectors and clamps.

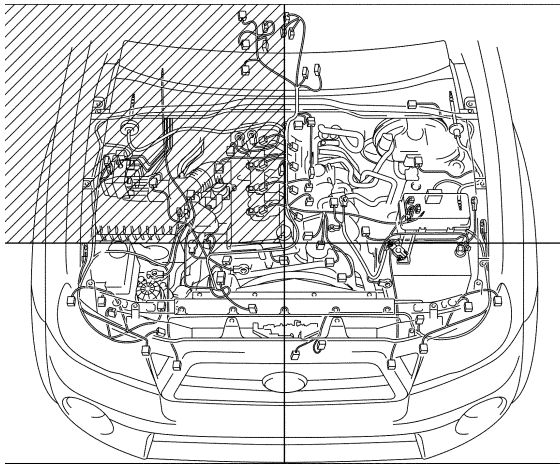

A1: Brake Actuator Assembly
A2: Air Injection Control Driver
A3: Skid Control Sensor Wire
A4: Frame Wire No.1

*1: 10,11MY
*2: From 12MY

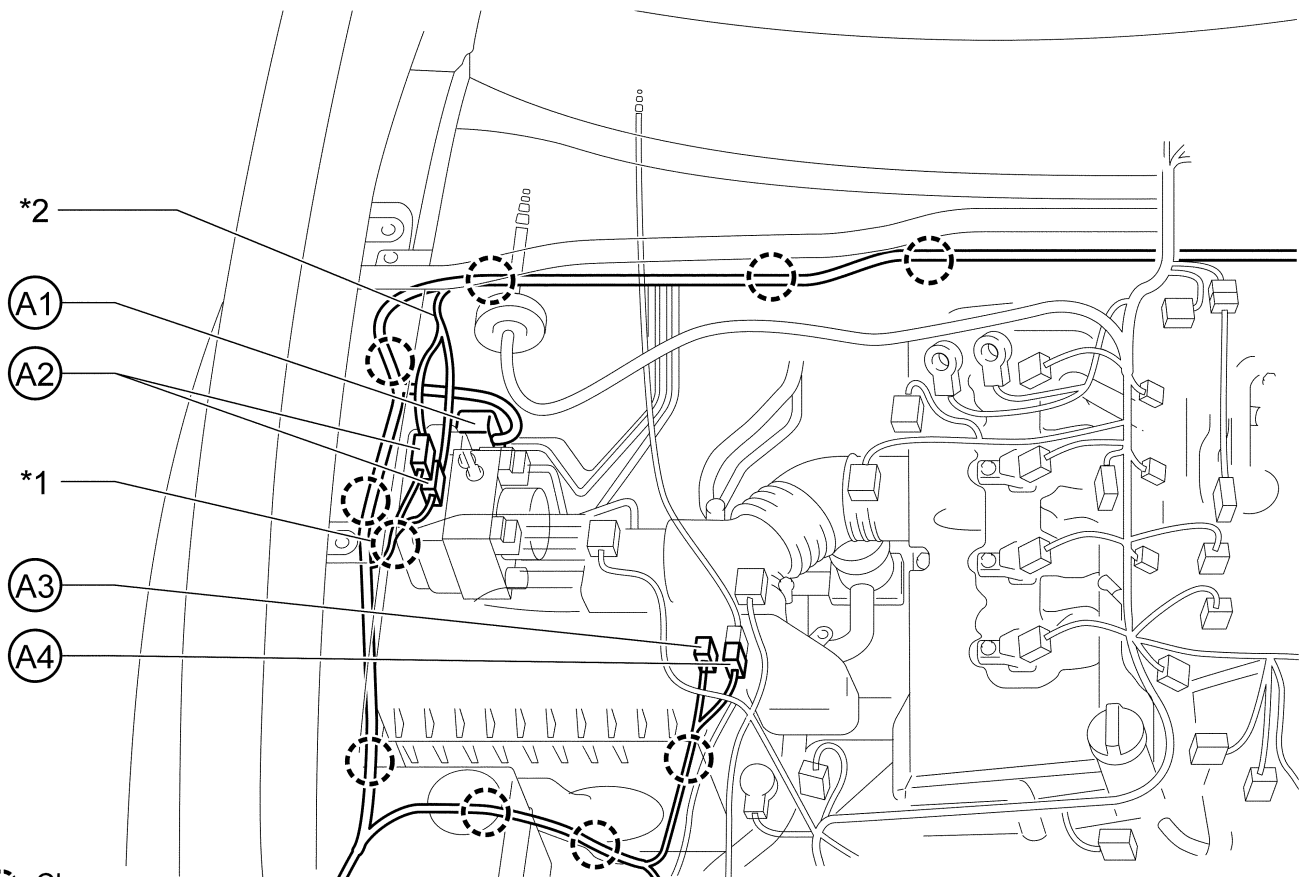

S58011aS

11. REINSTALL WINDSHIELD WASHER JAR

- a) Install the washer jar and 2 bolts.

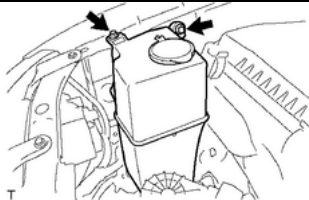

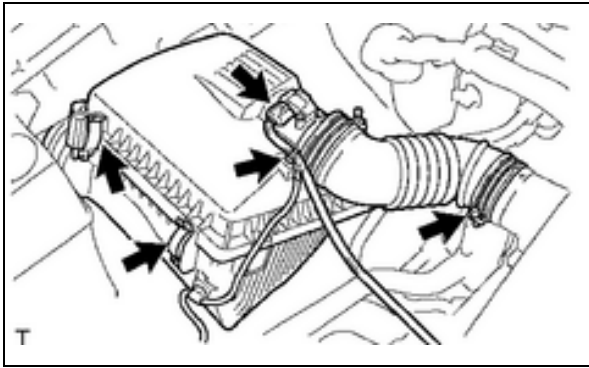

12. REINSTALL AIR CLEANER

- Install the air cleaner base and 3 bolts.
Torque Spec: 12.Nm (122 kgf-cm, 9 ft-lbf)
- Install filter element.
- Install air cleaner cap and hose.
- Connect the mass air flow meter connector.
- Connect the wire harness clamp.
- Tighten the hose clamp bolt, and connect the air cleaner hose No. 1.
- Connect the 2 air cleaner lid clamps.

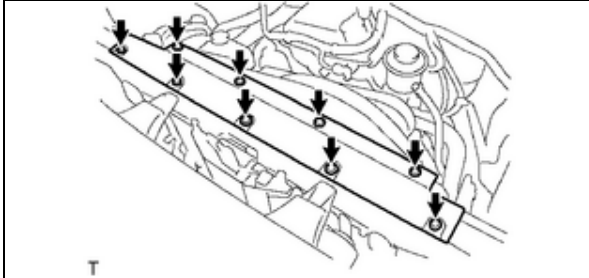

13. REINSTALL RADIATOR SUPPORT TO FRAME SEAL LH

- Install seal and engage the 9 clips.

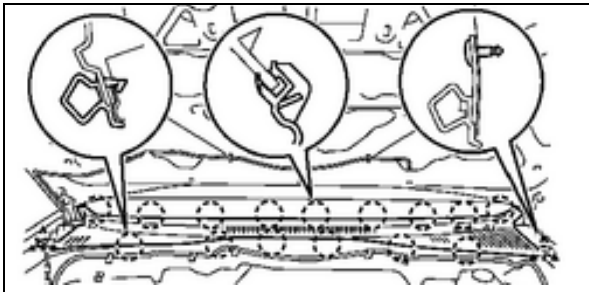

14. REINSTALL COWL TOP VENTILATOR LOUVER

- Install the louver and engage the 15 claws.
- Reinstall the RH and LH side front fender to cowl seal by engaging the 2 claws as shown.

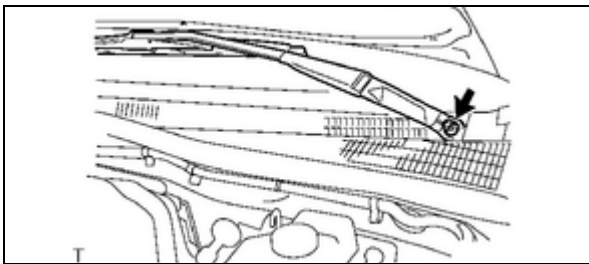
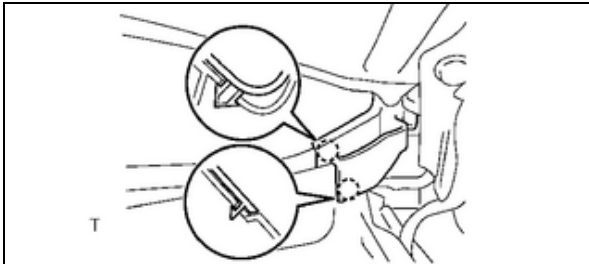

15. REINSTALL THE WINDSHIELD WIPERS

- Install the wiper arms.
- Install the wiper arm nuts.
Torque Spec: 21 Nm (209 kgf-cm, 15 ft-lbf)
- Install the wiper arm caps.

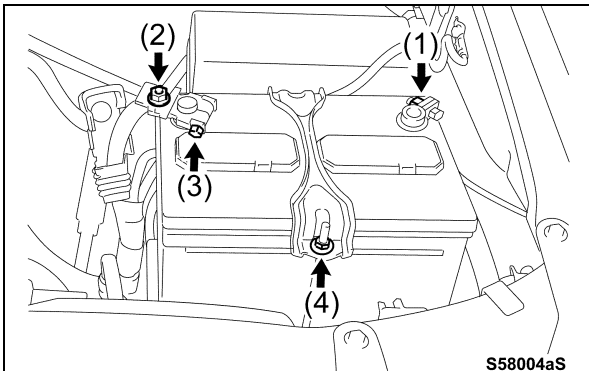

17. REINSTALL BATTERY

- Reinstall battery tray.
- Install the battery.
- Install the battery bracket and tighten the nut.
Torque Spec: 5.4 Nm (55 kgf-cm, 48 in-lbf)
- Connect both the negative and positive battery cables.
- Remove the nut and battery securing bracket.
- Remove battery assembly.

S58004aS

IX. ENGINE WIRE HARNESS REPLACEMENT

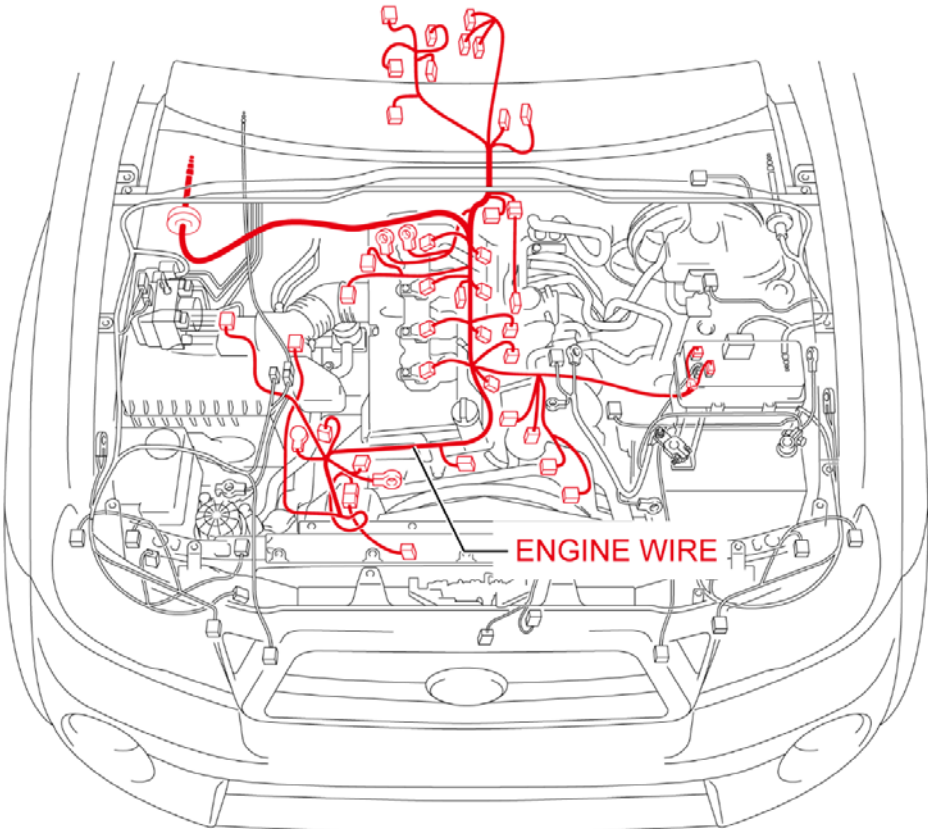

S58007aS

COMPONENTS TO BE REPLACED/REMOVED OVERVIEW

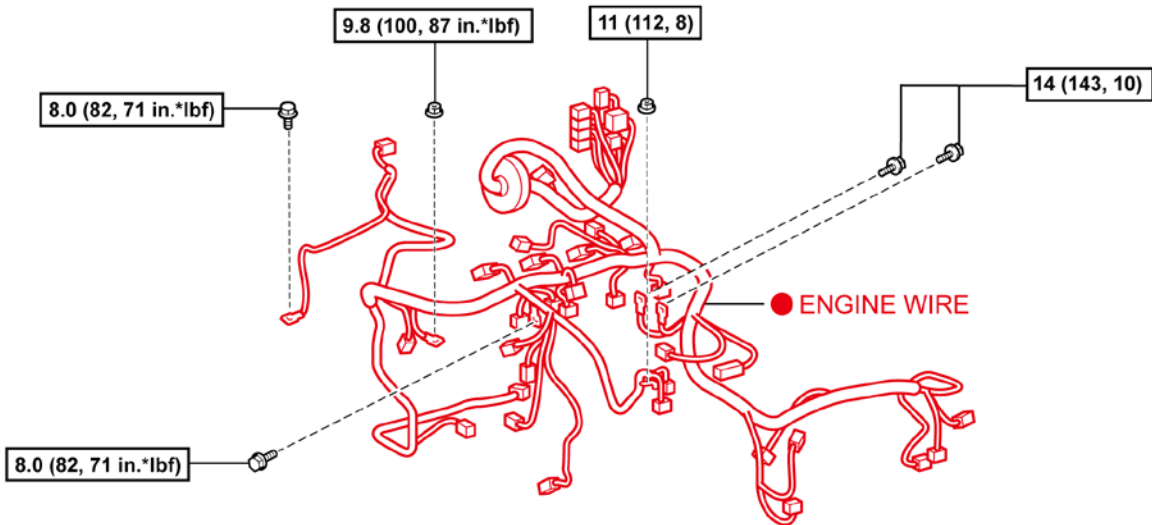
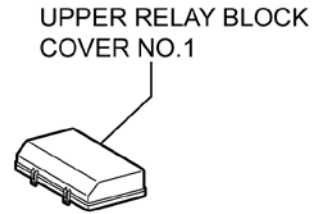
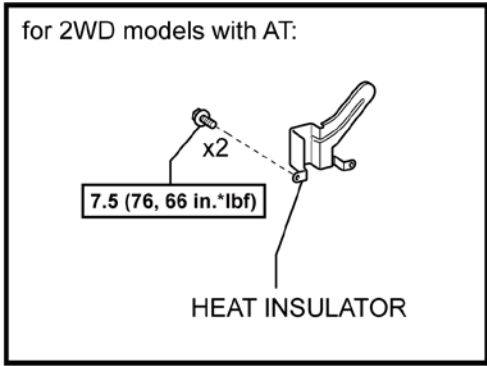
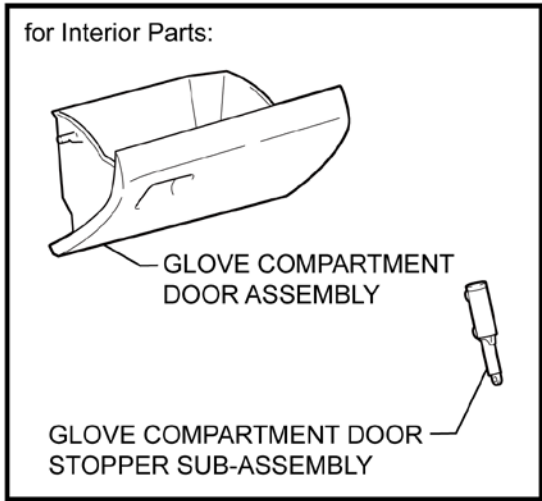
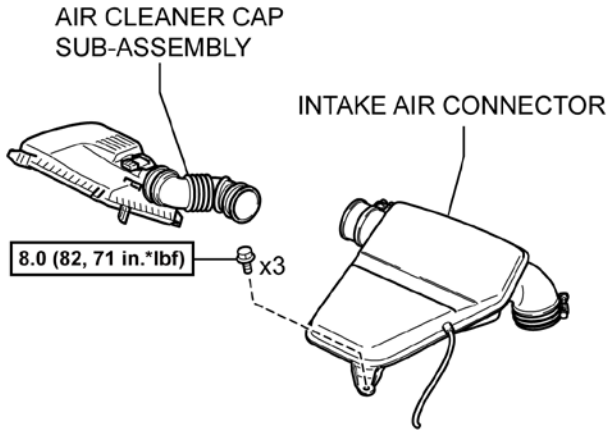

● :Component to be replaced

N*m (kgf*cm, ft.*lbf) : Specified torque

S58028aS

A. ENGINE WIRE HARNESS REMOVAL

1. DISCONNECT THE BATTERY

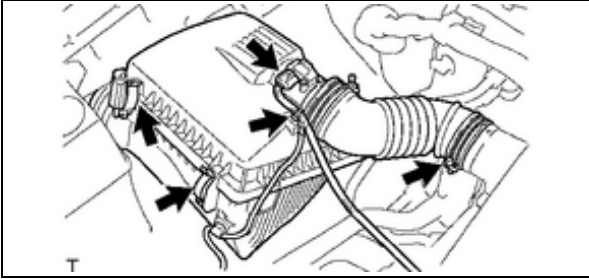

2. REMOVE AIR CLEANER CAP

- a) Disconnect the mass air flow meter connector.
- b) Disconnect the wire harness clamp.
- c) Loosen the hose clamp bolt, then disconnect the air cleaner hose No. 1.
- d) Disconnect the 2 air cleaner lid clamps.
- e) Remove the air cleaner cap together with the air cleaner hose No. 1.

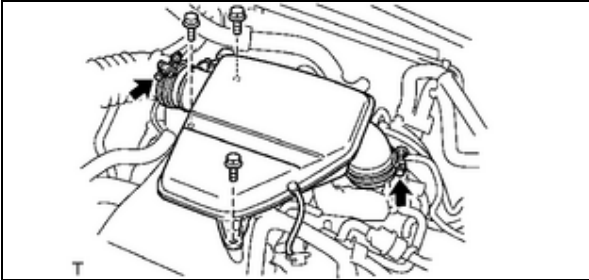

3. REMOVE INTAKE AIR CONNECTOR

- a) Disconnect the pressure sensor connector.
- b) Disengage the wire harness clamp.
- c) Disconnect the vacuum hoses.
- d) Disconnect the No. 2 ventilation hose.
- e) Loosen the hose clamp bolt.
- f) Remove the 3 bolts and the air connector.

4. REMOVE ENGINE WIRE FROM ENGINE ROOM

- a) Remove the upper relay block cover No. 1.
- b) Disconnect the connectors and disengage the clamps as shown in the following illustrations.
- c) Remove the 4 bolts and 2 nuts.



- Exact wire harness configuration can vary based on vehicle model year, use the following pages as a guide when disconnecting the harness.
- The vehicle engine bay is broken up into 4 quadrants for your reference.
- Use the following pages as a check sheet to ensure you remove all connectors and clamps.

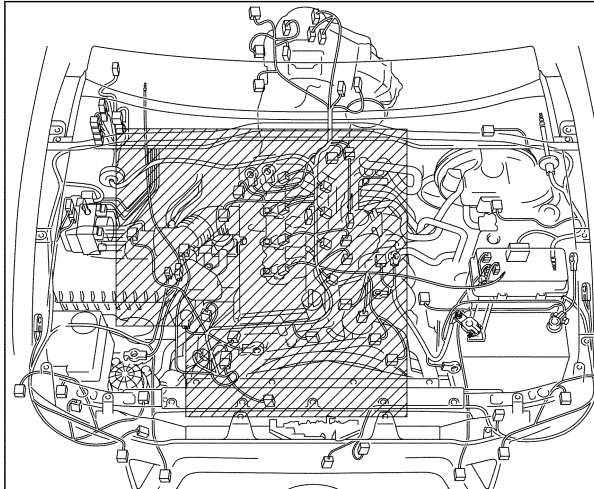

- | | |
|--|---|
| E1: Body Ground | G1: Wire to Wire |
| E2: Vacuum Sensor Assembly (For E.F.I.) | G2: Water Temperature Sensor (For E.F.I.) |
| E3: Air Switching Valve Assembly | G3: Throttle w/ Motor Body Assembly |
| E4: Mass Air Flow Sensor | G4: Wire to Wire |
| E5: Alternator Assembly | G5: Wire to Wire |
| E6: Alternator Assembly (Nut) | G6: Nut |
| E7: Body Ground | G7: Vacuum Switching Valve Assembly No.1 |
| F1: Oil Pressure Switch Assembly (For Engine) | G8: Power Steering Oil Pressure Switch |
| F2: Wire to Wire | G9: Cooler Compressor Assembly |
| F3: Body Ground | |
| F4: Ignition Coil Assembly | |
| F5: Cam Position Sensor | |
| F6: Fuel Injector Assembly | |
| F7: Camshaft Timing Oil Control Valve Assembly | |
| F8: Crank Position Sensor | |

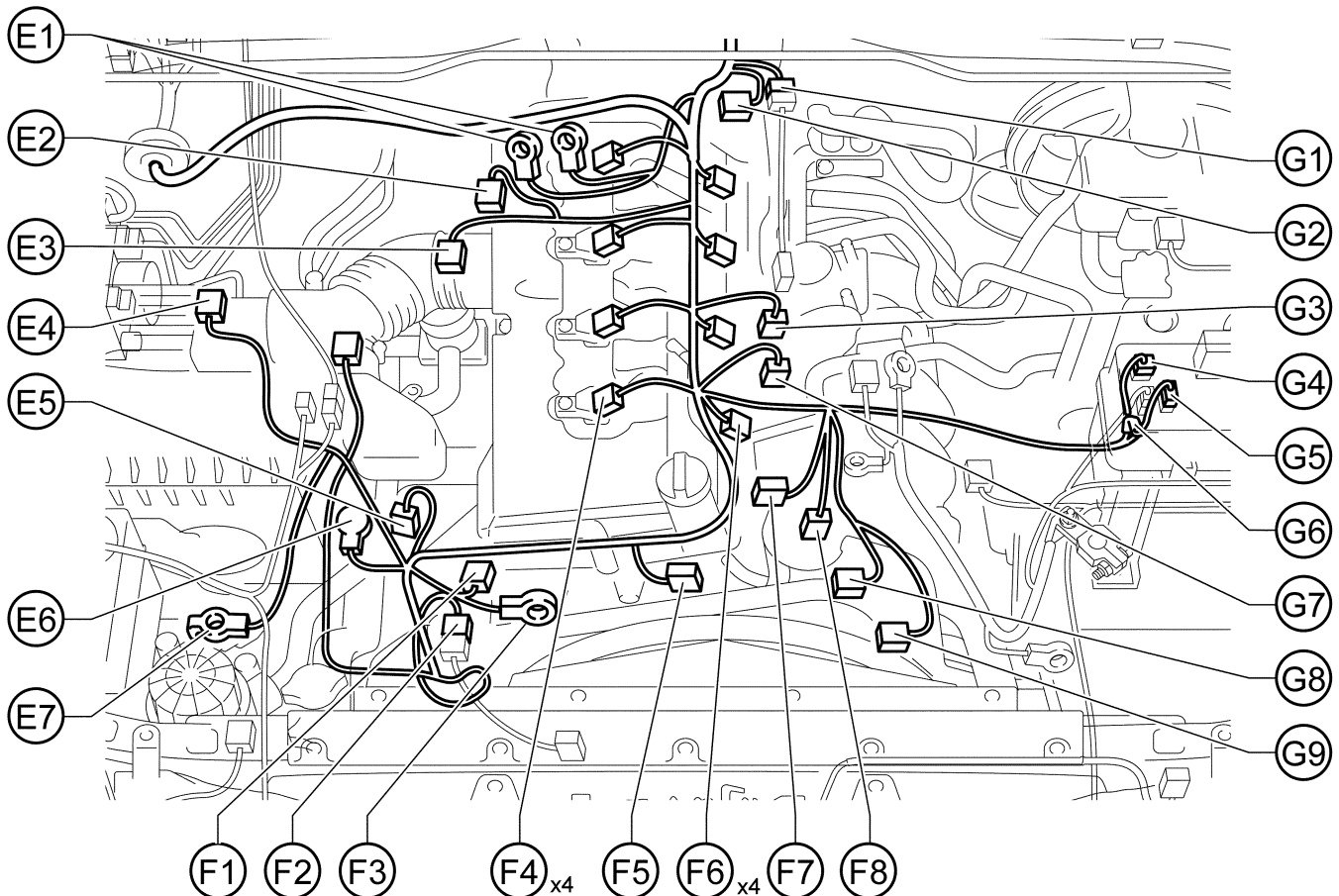

S58024aS

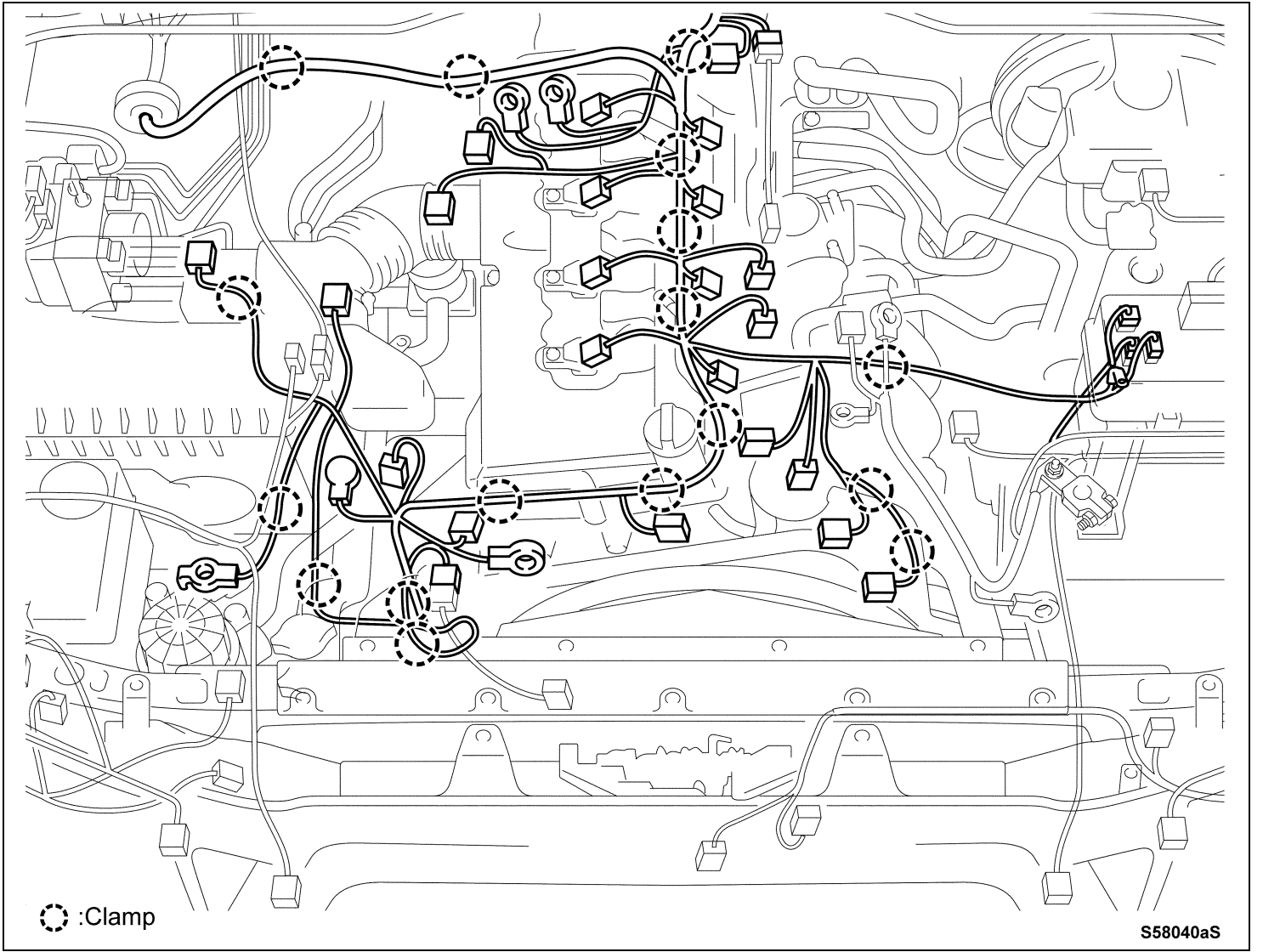

- d) Raise the vehicle.
- e) Remove the heat insulator (A/T trans only).
- f) Disconnect the connectors and disengage the clamps on the transmission as shown.



- Exact wire harness configuration can vary based on vehicle model year, use the following pages as a guide when disconnecting the harness.
- The engine wire clamps/connectors are broken up into 4 quadrants for your reference.
- Use the following pages as a check sheet to ensure you remove all connectors and clamps.

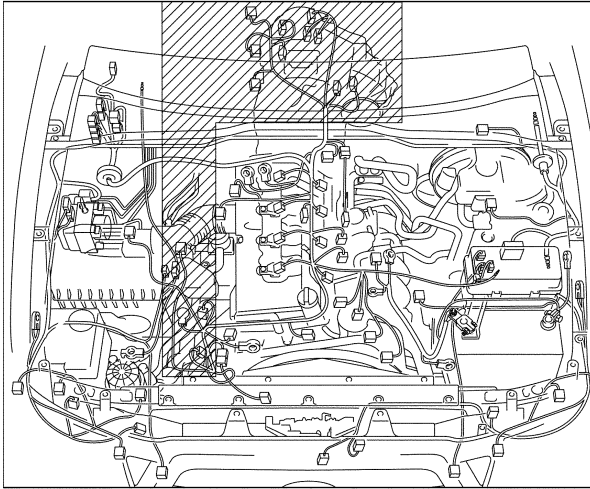

- H1: Oxygen Sensor
- H2: Speedometer Sensor (A/T)
- H3: Speedometer Sensor (M/T)
- H4: Electronically Controlled Transmission Solenoid (A/T)
- H5: Neutral Start Switch Assembly (A/T)
Back-up Lamp (M/T)
- H6: Air Fuel Ratio Sensor
- J1: Transfer Indicator Switch No.1 (4WD)
- J2: Transfer Shift Actuator Assembly (4WD)
- J3: Transfer Indicator Switch No.2 (4WD)
- J4: Transmission Revolution Sensor (A/T)
- J5: Temperature Sensor (A/T)

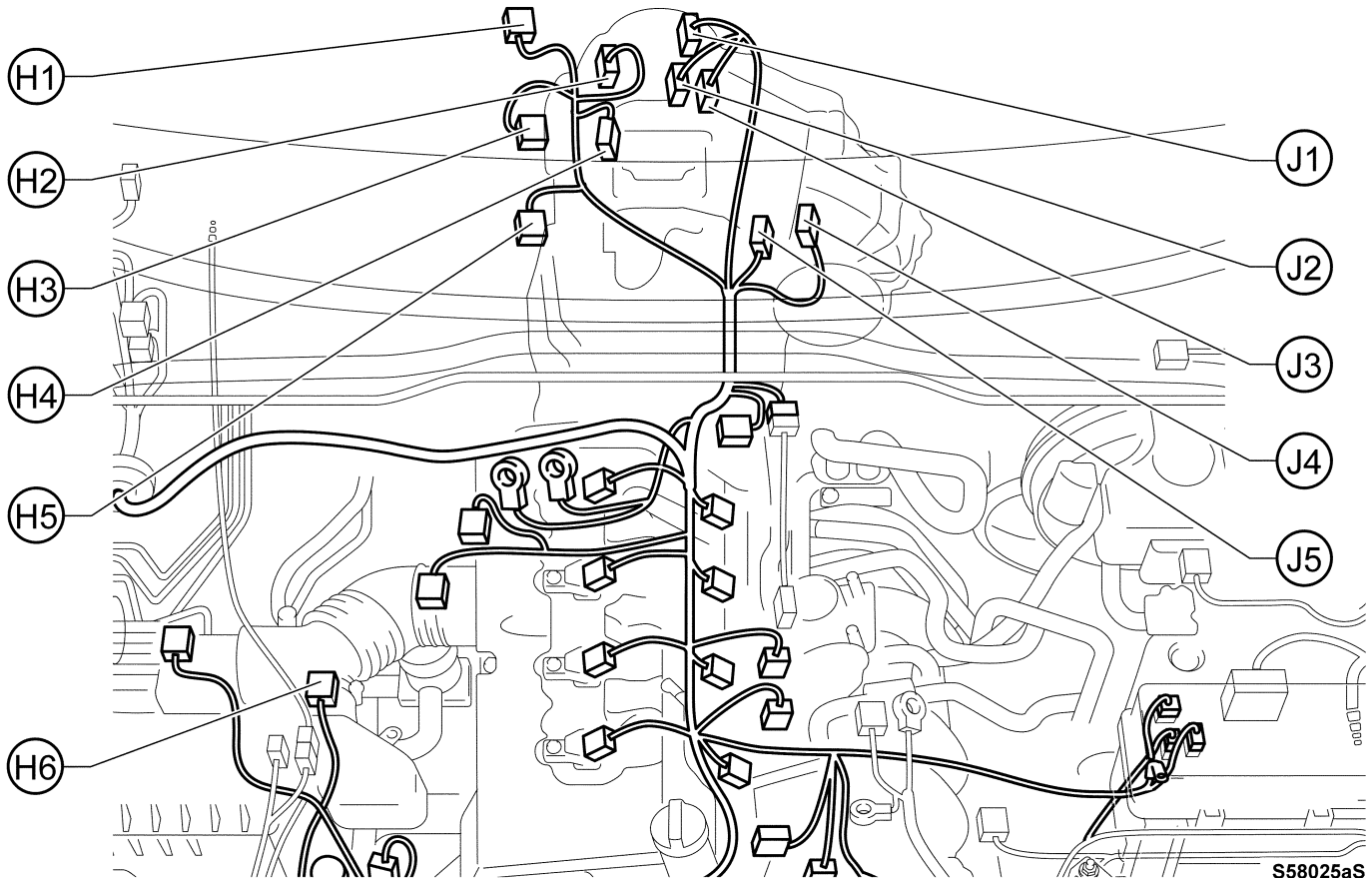

S58025aS

The clamp positions and the number of clamps vary depending on the model year and model specifications.

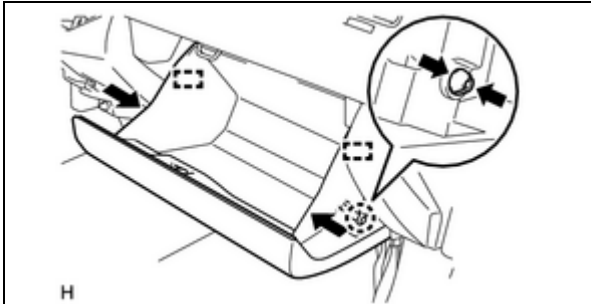
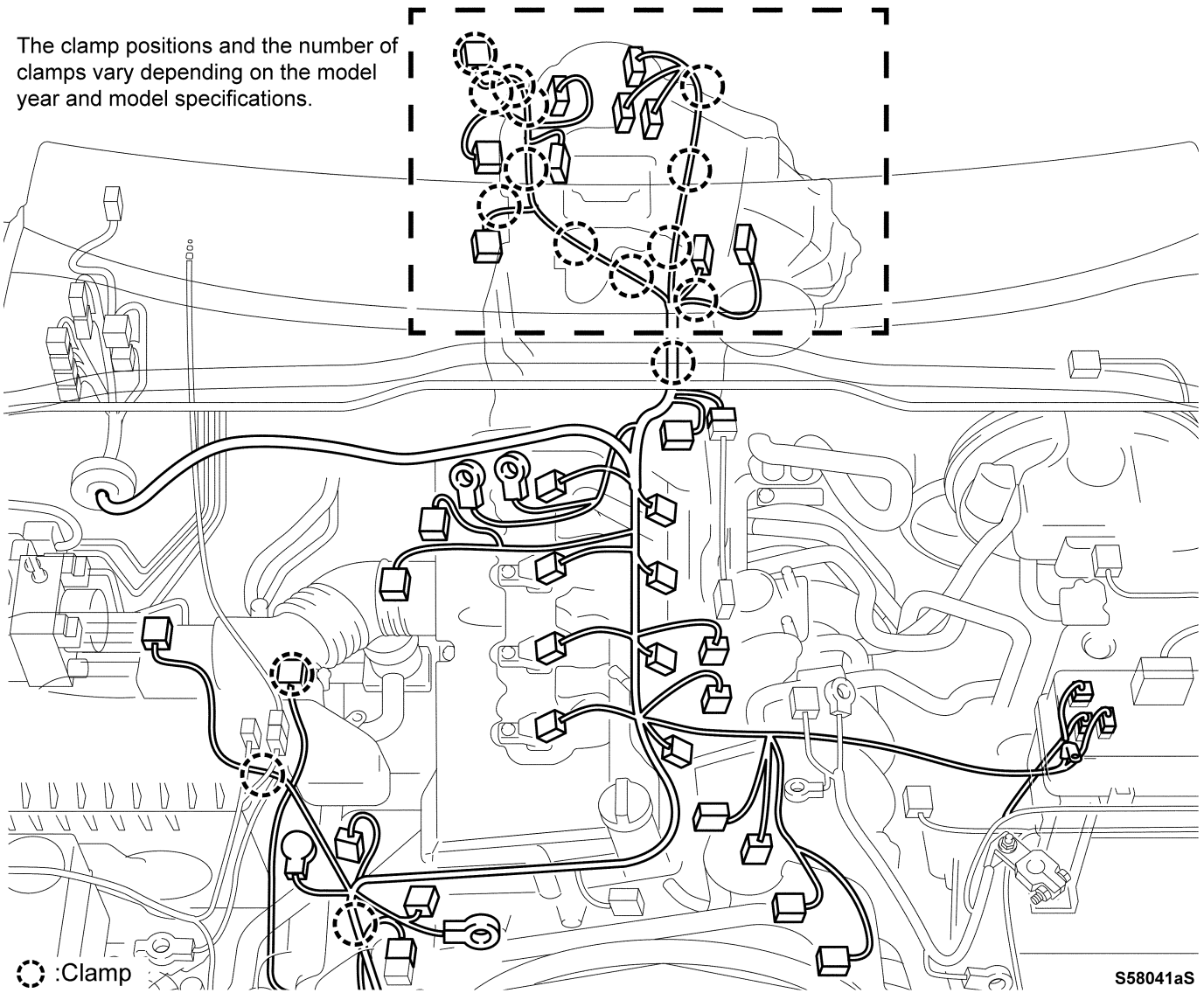

1. DISCONNECT THE ENGINE WIRE FROM VEHICLE CABIN

- a) Lower the vehicle.
- b) Remove the glove box door.
- c) Disengage the claw and separate the glove box door from the glove box stopper.
- d) Slightly compress the side wall of the glove box door carefully until it is horizontal, then pull the glove box door toward the rear of the vehicle.
- e) Disconnect the connectors and disengage the wire harness clamps.
- f) Release the wire harness grommet and pull the harness from the vehicle cabin toward the engine room.

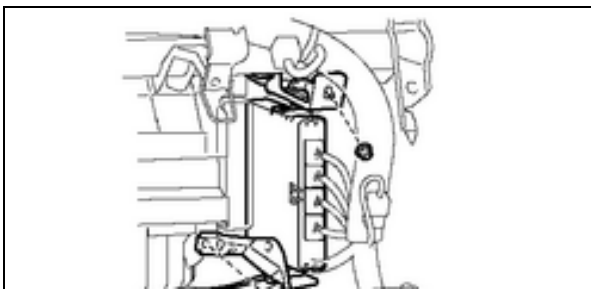

B. NEW ENGINE WIRE HARNESS INSTALLATION

1. ROUTE AND CONNECT THE ENGINE WIRE HARNESS

- Connect the connectors and engage the clamps as shown in the following illustrations.
- Reinstall the 4 bolts and 2 nuts.

Torque Spec:

E1: 14 Nm (143 kgf-cm, 10 ft-lbf)
E6: 9.8 Nm (100 kgf-cm, 87 in-lbf)
E7, F3: 8.0 Nm (82 kgf-cm, 71 in-lbf)
G8: 11.0 Nm (112 kgf-cm, 8 ft-lbf)



- Exact wire harness configuration can vary based on vehicle model year, use the following pages as a guide when disconnecting the harness.
- The vehicle engine bay is broken up into 4 quadrants for your reference.
- Use the following pages as a check sheet to ensure you remove all connectors and clamps.

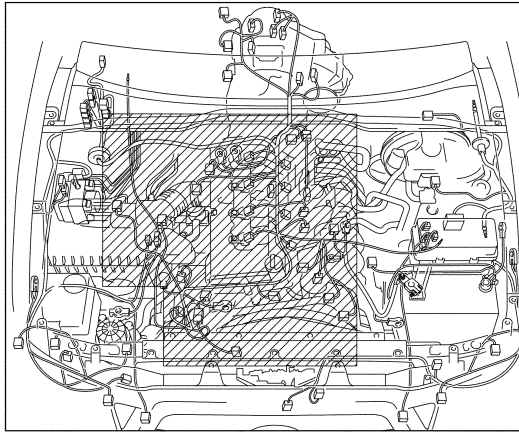

- | | |
|--|---|
| E1: Body Ground | G1: Wire to Wire |
| E2: Vacuum Sensor Assembly (For E.F.I.) | G2: Water Temperature Sensor (For E.F.I.) |
| E3: Air Switching Valve Assembly | G3: Throttle w/ Motor Body Assembly |
| E4: Mass Air Flow Sensor | G4: Wire to Wire |
| E5: Alternator Assembly | G5: Wire to Wire |
| E6: Alternator Assembly (Nut) | G6: Nut |
| E7: Body Ground | G7: Vacuum Switching Valve Assembly No.1 |
| F1: Oil Pressure Switch Assembly (For Engine) | G8: Power Steering Oil Pressure Switch |
| F2: Wire to Wire | G9: Cooler Compressor Assembly |
| F3: Body Ground | |
| F4: Ignition Coil Assembly | |
| F5: Cam Position Sensor | |
| F6: Fuel Injector Assembly | |
| F7: Camshaft Timing Oil Control Valve Assembly | |
| F8: Crank Position Sensor | |

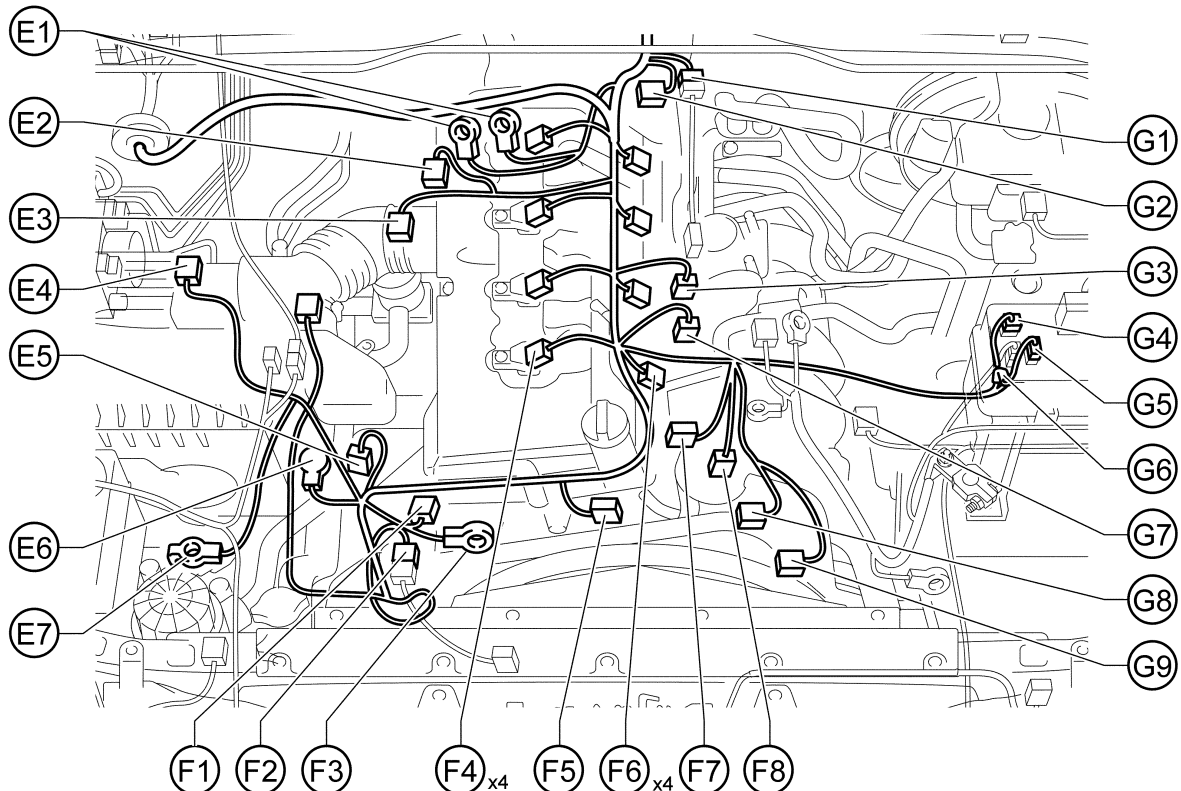

S58024aS

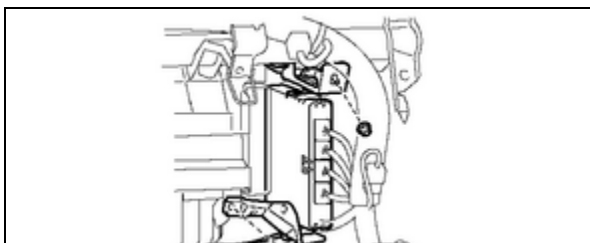
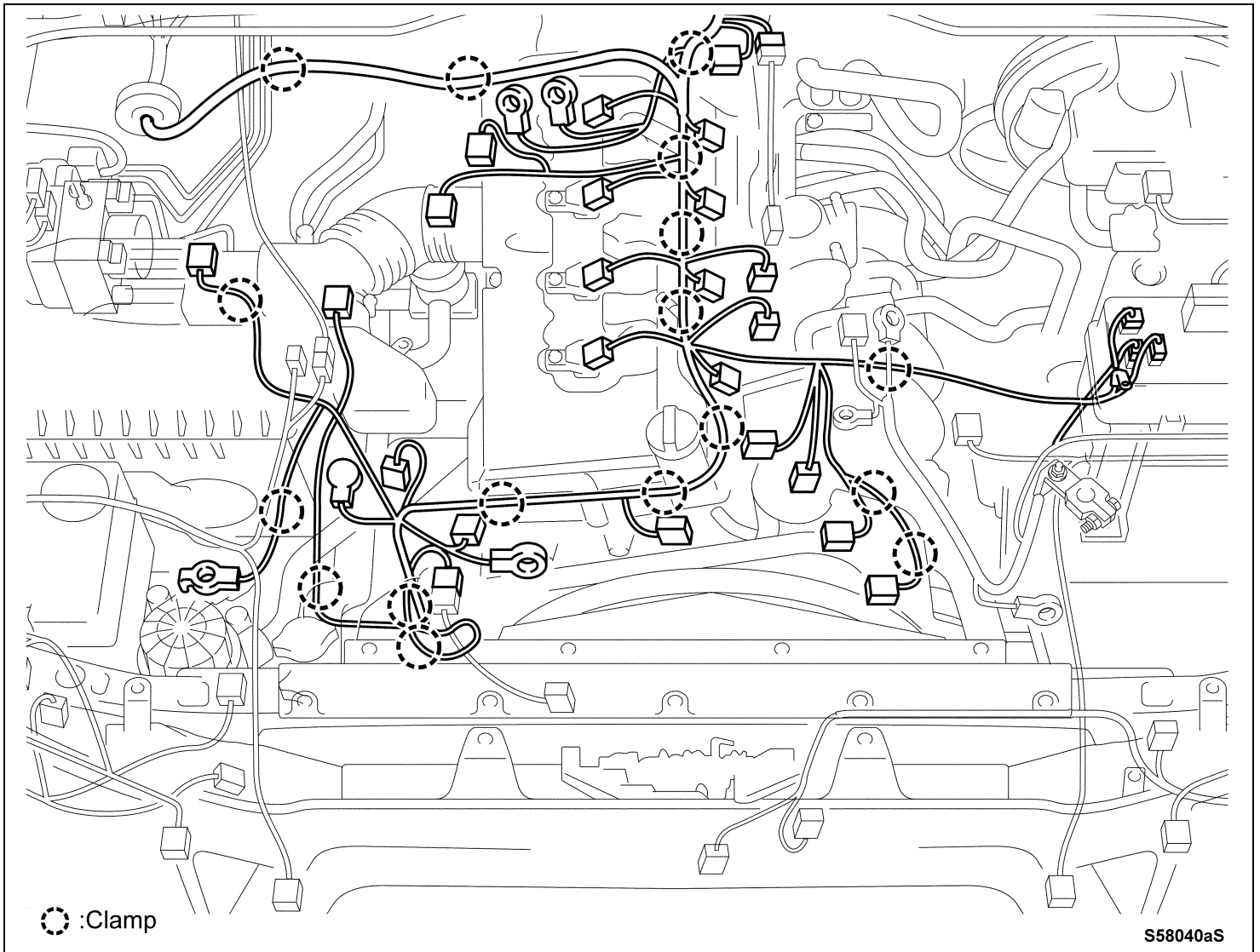

2. REINSTALL THE ENGINE HARNESS IN THE VEHICLE CABIN

- a) Pass the engine wire harness through the bulk head and into the vehicle cabin.
- b) Install the connectors and clamps.
- c) Confirm that the grommet is installed on the bulk head.

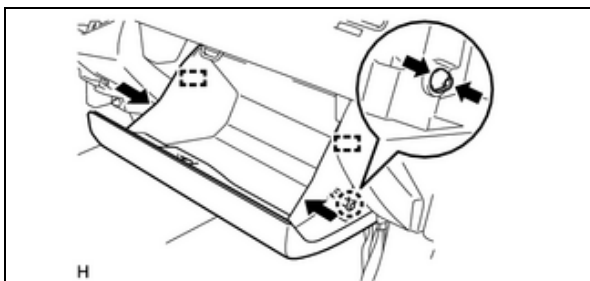

3. REINSTALL THE GLOVE BOX

- a) Engage the glove box door hinges
- b) Swing the door up and slightly compress the sides.
- c) Engage the claw on the glove box door stop.

- d) Raise the vehicle.
- e) Connect the connectors and engage the clamps on the transmission as shown.
- f) Reinstall the heat insulator. (A/T trans only)

Torque Spec: 7.5 Nm (76 kgf-cm, 66 in-lbf)



- Exact wire harness configuration can vary based on vehicle model year, use the following pages as a guide when disconnecting the harness.
- The engine wire clamps/connectors are broken up into 4 quadrants for your reference.
- Use the following pages as a check sheet to ensure you remove all connectors and clamps.

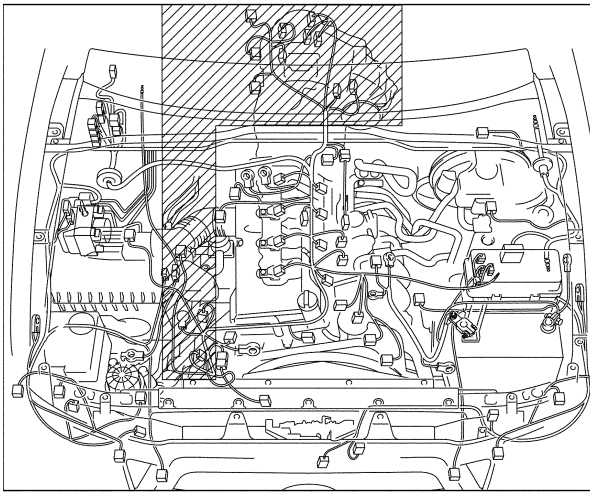

- H1: Oxygen Sensor
- H2: Speedometer Sensor (A/T)
- H3: Speedometer Sensor (M/T)
- H4: Electronically Controlled Transmission Solenoid (A/T)
- H5: Neutral Start Switch Assembly (A/T)
Back-up Lamp (M/T)
- H6: Air Fuel Ratio Sensor
- J1: Transfer Indicator Switch No.1 (4WD)
- J2: Transfer Shift Actuator Assembly (4WD)
- J3: Transfer Indicator Switch No.2 (4WD)
- J4: Transmission Revolution Sensor (A/T)
- J5: Temperature Sensor (A/T)

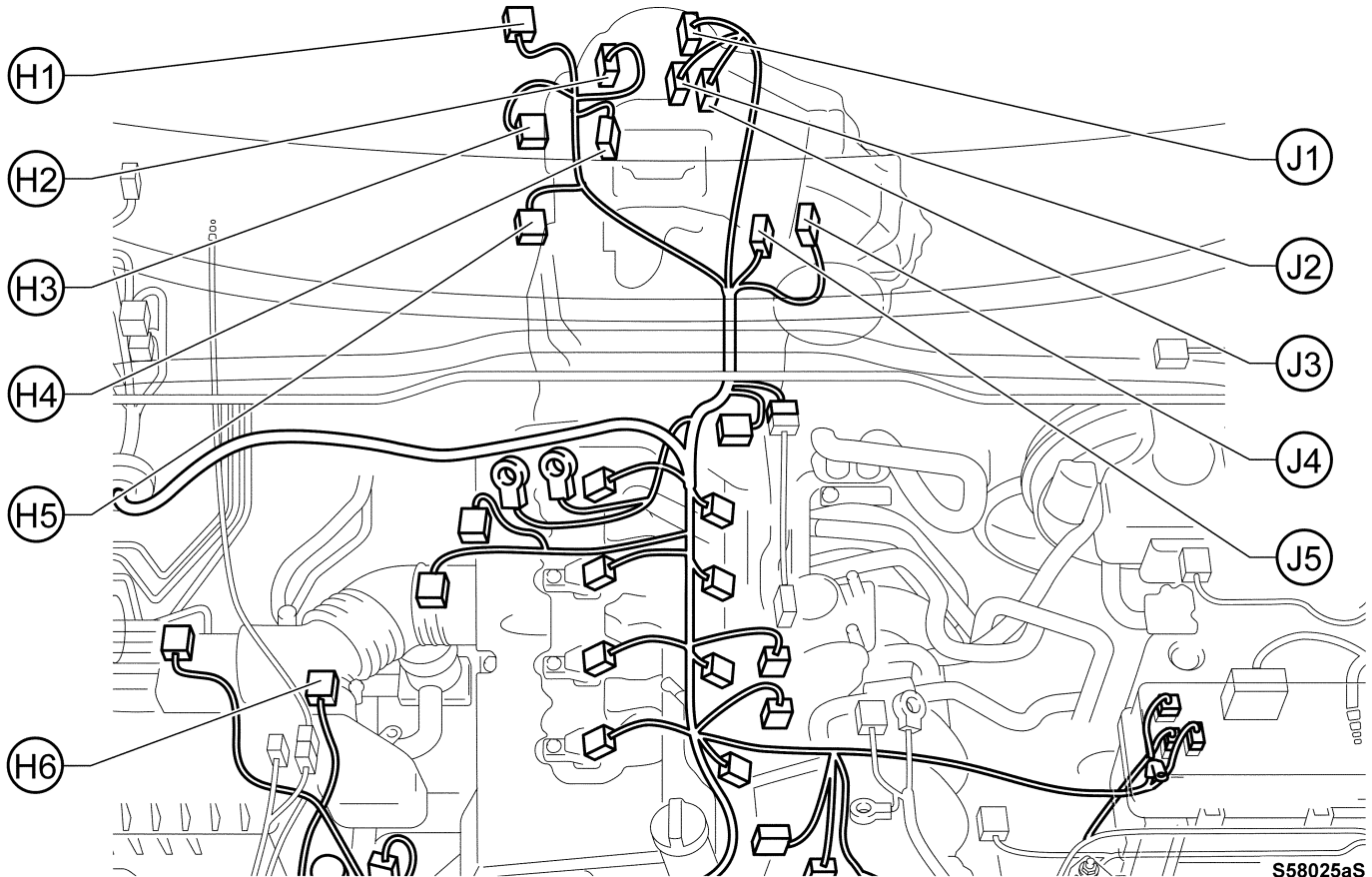

S58025aS

The clamp positions and the number of clamps vary depending on the model year and model specifications.

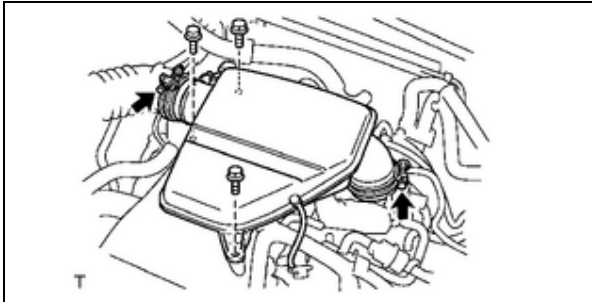
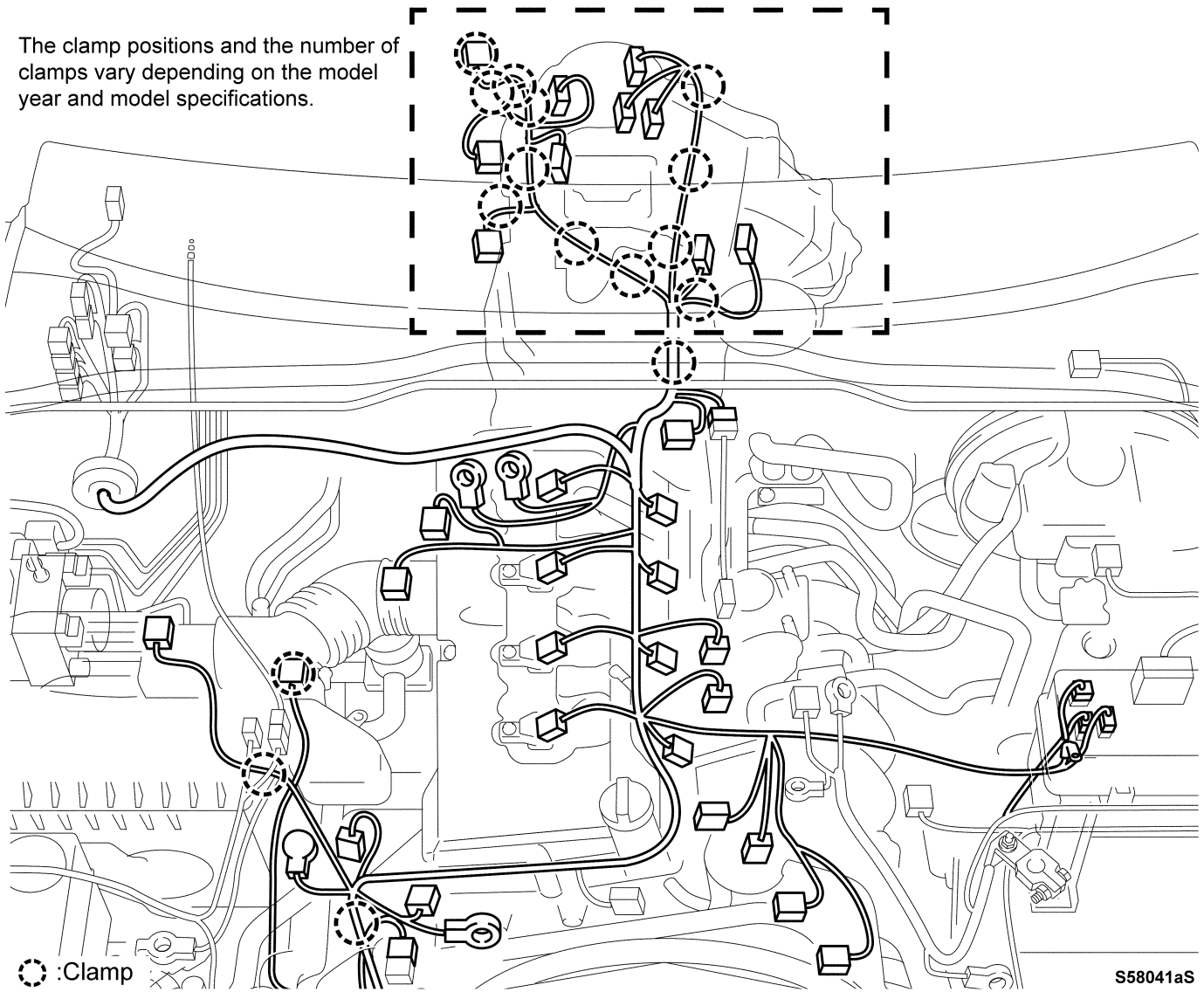

5. REINSTALL INTAKE AIR CONNECTOR

- a) Install the air intake connector.
 - b) Install the 3 bolts.
- Torque Spec: 12 Nm (122 kgf-cm, 9ft-lbf)**
- c) Tighten the hose clamp bolt.
 - d) Connect the vacuum hoses.
 - e) Connect the No. 2 ventilation hose.

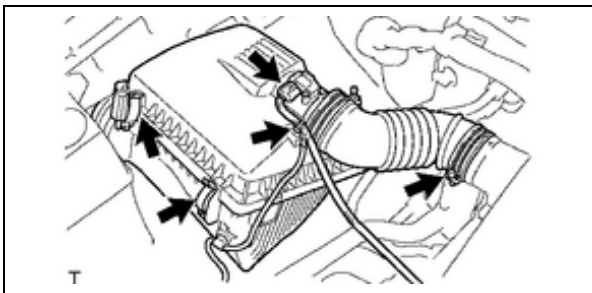

6. REINSTALL AIR CLEANER CAP

- a) Install filter element.
- b) Install air cleaner cap and hose.
- c) Connect the mass air flow meter connector.
- d) Connect the wire harness clamp.
- e) Tighten the hose clamp bolt, and connect the air cleaner hose No. 1.
- f) Connect the 2 air cleaner lid clamps.

7. RECONNECT BATTERY

8. PROCEED TO SECTON X: FINAL VEHICLE CHECK

X. FINAL VEHICLE CHECK

1. CHECK AND CLEAR DTC
2. CHECK FOR ENGINE COOLANT LEAK
3. CHECK FOR BRAKE FLUID LEAK
4. CHECK FOR REFRIGERANT LEAK
5. CONDUCT TEST DRIVE
6. RESTORE SYSTEM SETTINGS



- All catalytic converters must be returned to Toyota, the CPS system will send you a request the day after the warranty claim is approved.
- If the catalytic converters are not returned the warranty claims are subject to debit and core charges.
- Do not ship the full exhaust pipe assembly back to Toyota. If the exhaust pipe is shipped back as a complete unit your dealer will be debited for the additional shipping charges.

◀ VERIFY REPAIR QUALITY ▶

- Confirm that there are no exhaust leaks
- Confirm that all components were inspected and replaced as needed
- Confirm that the catalytic converter is returned to Toyota (REQUIRED)

If you have any questions regarding this update, please contact your regional representative.

XI. APPENDIX

A. CAMPAIGN DESIGNATION DECODER

