

September 22, 2017

06899 Version 2

Warranty Extension: TLX Transmission Chirps During 3-4 Shift, Poor Shift Quality, or Engine Overheats Because of Defective ATF Warmer

AFFECTED VEHICLES

Year	Model	Trim	VIN Range
2015–16	TLX	All with 9-speed A/T	Check the iN VIN status for eligibility

BACKGROUND

American Honda is extending the warranty on the 9-speed transmission warmers to 10 years from the original date of purchase with unlimited mileage.

This warranty covers vehicles where the engine coolant and ATF mix because of an internal leak in the 9-speed transmission warmer.

No fluid will be visible outside of the warmer.

If the transmission warmer leaks, it may cause one or more of the following symptoms:

- **The vehicle overheats**
- **The transmission shifts poorly**
- **The transmission makes during 3-4 shift**

This bulletin only applies to vehicles where the **client came in with at least one of the listed complaints and the warmer fails the pressure test.**

Transmission warmers may be called in for inspection and if they are found to be not leaking, your claim will be subject to debit.

This warranty extension will not apply to any vehicle that has ever been declared a total loss or sold for salvage by a financial institution or insurer, or has a branded or similar title under any state's law.

CLIENT NOTIFICATION

Owners of affected vehicles will be sent a notification of this warranty extension.

Do an iN VIN status inquiry to make sure the vehicle is shown as eligible.

CLIENT INFORMATION: The information in this bulletin is intended for use only by skilled technicians who have the proper tools, equipment, and training to correctly and safely maintain your vehicle. These procedures should not be attempted by "do-it-yourselfers," and you should not assume this bulletin applies to your vehicle, or that your vehicle has the condition described. To determine whether this information applies, contact an authorized Acura automobile dealer.

CORRECTIVE ACTION

Inspect the vehicle and based on your inspection, do one of the following:

- The transmission warmer is OK. Continue with normal troubleshooting.
- Replace the transmission, radiator, coolant hoses, thermostat, coolant reserve tank, ECT (1 and 2) sensor O-rings and flush the cooling system.
- Replace the short block, cylinder heads, transmission, radiator, thermostat, coolant reserve tank, all of the coolant hoses, the 2 ECT sensor (1 and 2) O-rings, water passage, water connecting pipe, and flush the heater core.

NOTE: Photos are required every time a transmission is replaced - see page 15. Any transmission replacement claims that do not include the required photos may be subject to debit.

The flowchart below provides a summary to help navigate the inspection and repair procedure. Make sure you read the service bulletin steps thoroughly for the detailed repair information.

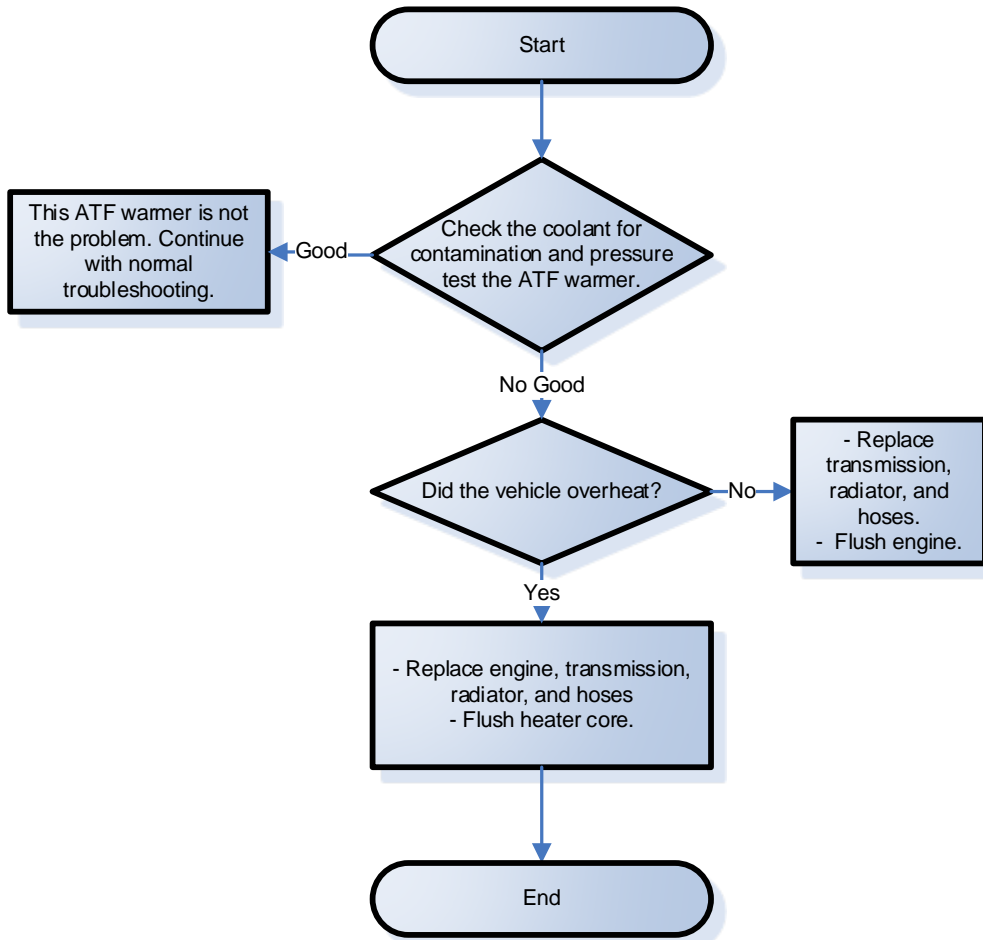

WARRANTY CLAIM INFORMATION

Inspect Warmer Only

Operation Number	Description	Flat Rate Time	Defect Code	Symptom Code	Template ID	Failed Part Number
2325A1	Inspect the ATF warmer, reinstall the original warmer with new O-Rings	2.1 hrs	6A900	KG800	B17027A	06200-5J4-A71

Inspection and Repair Procedure A

NOTE: Photos must be submitted with any warranty claim where the transmission is replaced – see page 16. Any transmission replacement claims that do not include the required photos may be subject to debit.

Operation Number	Description	Transmission Replacement Number	Flat Rate Time	Defect Code	Symptom Code	Template ID	Failed Part Number
2185C0	2WD BASE/TECH - Inspect the ATF warmer, check vehicle for overheating and do REPAIR PROCEDURE A. - Replace transmission, radiator, and hoses - Flush engine - Includes photos, updating PCM/TCM, idle learn and alignment	06200-5J4-A71RM	10.5 hrs	6A900	KG800	B17027B	06200-5J4-A71
2185C0	2WD ADV - Inspect the ATF warmer, check vehicle for overheating and do REPAIR PROCEDURE A. - Replace transmission, radiator, and hoses - Flush engine - Includes photos, updating PCM/TCM, idle learn and alignment	06200-5J4-A81RM	10.5 hrs	6A900	KG800	B17027C	06200-5J4-A71
2185C1	AWD BASE/TECH - Inspect the ATF warmer, check vehicle for overheating and do REPAIR PROCEDURE A. - Replace transmission, radiator, and hoses - Flush engine - Includes photos, updating PCM/TCM, idle learn and alignment	06200-5L9-A72RM	10.9 hrs	6A900	KG800	B17027D	06200-5J4-A71
2185C1	AWD ADV - Inspect the ATF warmer, check vehicle for overheating and do REPAIR PROCEDURE A. - Replace transmission, radiator, and hoses - Flush engine - Includes photos, updating PCM/TCM, idle learn and alignment	06200-5L9-A81RM	10.9 hrs	6A900	KG800	B17027E	06200-5J4-A71

Inspection and Repair Procedure B

NOTE: Photos must be submitted with any warranty claim where the transmission is replaced – see page 16. Any transmission replacement claims that do not include the required photos may be subject to debit.

Operation Number	Description	Transmission Replacement Number	Flat Rate Time	Defect Code	Symptom Code	Template ID	Failed Part Number
2185C6	<p>2WD BASE/TECH - Inspect the ATF warmer, check vehicle for overheating and do REPAIR PROCEDURE B.</p> <ul style="list-style-type: none"> - Replace engine, transmission, radiator, and hoses - Flush heater core - Includes photos, updating PCM/TCM, idle learn and alignment 	06200-5J4-A71RM	12.7 hrs	6A900	KG800	B17027F	06200-5J4-A71
2185C6	<p>2WD ADV - Inspect the ATF warmer, check vehicle for overheating and do REPAIR PROCEDURE B.</p> <ul style="list-style-type: none"> - Replace engine, transmission, radiator, and hoses - Flush heater core - Includes photos, updating PCM/TCM, idle learn and alignment 	06200-5J4-A81RM	12.7 hrs	6A900	KG800	B17027G	06200-5J4-A71
2185C7	<p>AWD BASE/TECH - Inspect the ATF warmer, check vehicle for overheating and do REPAIR PROCEDURE B.</p> <ul style="list-style-type: none"> - Replace engine, transmission, radiator, and hoses - Flush heater core - Includes updating PCM/TCM, idle learn and alignment 	06200-5L9-A72RM	13.1 hrs	6A900	KG800	B17027H	06200-5J4-A71
2185C7	<p>AWD ADV - Inspect the ATF warmer, check vehicle for overheating and do REPAIR PROCEDURE B.</p> <ul style="list-style-type: none"> - Replace engine, transmission, radiator, and hoses - Flush heater core - Includes updating PCM/TCM, idle learn and alignment 	06200-5L9-A81RM	13.1 hrs	6A900	KG800	B17027I	06200-5J4-A71

PARTS INFORMATION-WARMER INSPECTION ONLY

Part Name	Part Number	Quantity
O-Ring (warmer pipes) (Not needed if the transmission is replaced)	25931-5NC-003	8

PARTS INFORMATION - REPAIR PROCEDURE A

Part Name	Part Number	Quantity
Transmission		1
2WD Base and Tech	06200-5J4-A71RM	
2WD Advanced	06200-5J4-A81RM	
AWD Base and Tech	06200-5L9-A72RM	
AWD Advanced	06200-5L9-A81RM	
Flange Bolt (12 x 70 mm)	90051-R97-000	1
Flange Bolt (12 x 120 mm)	90051-5J4-000	1
Flange Nut (12 mm)	90371-SEF-000	4
Flange Bolt (10 x 35 mm)	90163-SDA-A01	1
Flange Bolt (10x 45 mm)	90163-TZ3-A00	1
Flange Bolt (10 x 30 mm)	90161-T2F-A01	3
Flange Bolt (12 x 45 mm)	90165-SDA-A00	2
Flange Bolt (12 x 45 mm)	90164-T2G-A01	1
Pre-Chamber Gasket	18393-SDB-A00	2
Exhaust Pipe Gasket (ISHINO)	18212-SA7-003	2
Self-Lock Nut (10 mm)	90212-SA5-003	9
Bolt (12 point 8 x 21 mm)	90113-S10-000	8
Washer Bolt (10 x 30 mm)	90382-SZA-003	2
Split Pin (3.0 x 22 mm)	94201-30220	2
Castle Nut (14 mm)	90363-S3V-A01	2
Flange Bolt (10 x 45 mm)	90163-SZ3-000	3
Flange Bolt (14 x 135 mm)	90176-SDA-A00	2
Flange Bolt (10 x 77 mm)	90167-TZ7-A01	2
Flange Bolt (10 x 24 mm)	90166-TZ7-A01	2
Flange Bolt (14 x 150 mm)	90177-SDA-A00	2
Flange Bolt (8 x 16 mm)	90101-SWA-A00	2
Flange Bolt (12 x 33 mm)	90186-SDA-A00	2
Flange Bolt (10 x 34 mm)	90162-T2A-A00	4
Snap Ring (32 x 2.2 mm)	44319-STX-A01	1
Set Ring (32 x 2.2 mm)	44319-STX-A60	1
Flange Bolt (10 x 30 mm)	90163-SDB-A00	3
Radiator (DENSO)	19010-5J2-A01	1
Reserve Tank	19101-5J2-A00	1

Reserve Tank Cap	19102-5J6-A00	1
Reserve Tank Joint	19106-RSA-G00	1
Reserve Tank Tube A	19103-5J2-A00	1
Reserve Tank Tube B	19104-5J2-A00	1
Water Hose (Lower) (A)	19502-5J2-A50	1
Water Hose (Lower) (B)	19504-5J2-A50	1
Water Hose (Upper)	19501-5J2-A00	1
Water Inlet Hose	79721-TZ3-A00	1
Water Outlet Hose Assembly	79725-TZ3-A00	1
Warmer Hose B (ATF)	19433-5J2-A00	1
Water Hose B	19522-R9P-A00	1
Water Hose C	19523-5J2-A00	1
Water Hose A	19521-5J2-A00	1
Warmer Hose A (ATF)	19432-5J2-A50	1
O-Ring (DENSO)	91307-RTA-005	2
Thermostat Cover Assembly	19315-5J2-A01	1

REQUIRED MATERIALS – REPAIR PROCEDURE A

Part Name	Part Number	Quantity
ATF Type 3.1 NOTE: 1 quart will fill 5 vehicles.	08200-9017A	1
Coolant Type 2	OL999-9011A	12

PARTS INFORMATION – REPAIR PROCEDURE B

Part Name	Part Number	Quantity
Transmission		1
2WD Base and Tech	06200-5J4-A71RM	
2WD Advanced	06200-5J4-A81RM	
AWD Base and Tech	06200-5L9-A72RM	
AWD Advanced	06200-5L9-A81RM	
Cylinder Block Assembly	10002-5J2-A00	1
Cylinder Head Assembly (Front)	10004-R9P-A01	1
Cylinder Head Assembly (Rear)	10005-5J6-A00	1
Exhaust Pipe Gasket (ISHINO)	18212-SA7-003	2
Pre-Chamber Gasket	18393-SDB-A00	1
Self-Lock Nut (10 mm)	90212-SA5-003	9
Bolt (12 point 8 x 21 mm) (AWD Only)	90113-S10-000	8
Washer Bolt (10 x 30 mm) (AWD Only)	90382-SZA-003	2
Split Pin (3.0 x 22 mm)	94201-30220	2
Castle Nut (14 mm)	90363-S3V-A01	2
Spindle Nut (24 mm)	90305-SD4-003	2
Flange Nut (12 mm)	90371-SEF-000	4
Flange Bolt (10 x 35 mm)	90163-SDA-A01	1
Flange Bolt (10 x 45 mm)	90163-TZ3-A00	1
Flange Bolt (10 x 60 mm)	90168-TA1-A00	2
Flange Bolt (12 x 45 mm)	90165-SDA-A00	2
Flange Bolt (12x 45 mm)	90164-T2G-A01	1
Flange Bolt (10 x 30 mm)	90163-SDB-A00	3
Flange Bolt (12 x 56 mm)	90170-TZ3-A00	4
Flange Bolt (10 x 85 mm)	90002-R70-A00	1
Flange Bolt (10 x 105 mm)	95801-10105-08	2
Flange Bolt (10 x 50 mm)	95701-10050-08	4
Intake Manifold Cover Gasket (Upper)	17112-5G0-A01	1
Intake Manifold Gasket (NIPPON LEAKLESS)	17105-R9P-A01	1
Throttle Body Gasket	16176-RYE-A10	1
Fuel Joint Pipe Set (MSDS includes VOC)	16012-R9P-305	1
Front Intake Manifold Base Gasket	17055-R9P-A01	1
Rear Intake Manifold Base Gasket	17065-R9P-A01	1

Injector Seal Set	16453-R9P-A00	1
O-Ring	91311-5A2-A01	1
Exhaust Chamber Gasket (NIPPON LEAKLESS)	18115-5G0-A01	2
EGR Pipe Gasket A	18716-R70-A01	1
EGR Pipe Gasket B	18719-R70-A01	1
Rear Cylinder Head Gasket (NIPPON LEAKLESS)	12261-R9P-A01	1
Front Cylinder Head Gasket (NIPPON LEAKLESS)	12251-R9P-A01	1
Timing Belt Idler Bolt	14551-RCA-A01	1
Front Water Passage Gasket (NIPPON LEAKLESS)	19411-5G0-A02	1
Rear Water Passage Gasket (NIPPON LEAKLESS)	19412-5G0-A01	1
O-Ring (Denso)	91307-RTA-005	2
Thermostat Cover Assembly	19315-5J2-A01	1
O-Ring (31.2 x 4.1 mm) (NOK)	91314-PH7-003	2
EGR Valve Gasket (ISHINO GASKET)	18715-PB2-000	1
Oil Filter	15400-PLM-A02	1
Radiator (DENSO)	19010-5J2-A01	1
Reserve Tank	19101-5J2-A00	1
Reserve Tank Cap	19102-5J6-A00	1
Reserve Tank Joint	19106-RSA-G00	1
Reserve Tank Tube A	19103-5J2-A00	1
Reserve Tank Tube B	19104-5J2-A00	1
Water Hose (Lower) (A)	19502-5J2-A50	1
Water Hose (Lower) (B)	19504-5J2-A50	1
Water Hose (Upper)	19501-5J2-A00	1
Water Inlet Hose	79721-TZ3-A00	1
Water Outlet Hose Assembly	79725-TZ3-A00	1
Warmer Hose B (ATF)	19433-5J2-A00	1
Water Hose B	19522-R9P-A00	1
Water Hose C	19523-5J2-A00	1
Water Hose A	19521-5J2-A00	1
Warmer Hose A (ATF)	19432-5J2-A50	1
Connecting Pipe	19505-5J2-A00	1
Water Passage	19410-5J2-A00	1
Flange Bolt (12 x 70 mm)	90051-R97-000	1
Flange Bolt (12 x 120 mm)	90051-5J4-000	1

Flange Bolt (10 x 30 mm)	90161-T2F-A01	3
Flange Bolt (10 x 45 mm)	90163-SZ3-000	3
Flange Bolt (14 x 135 mm)	90176-SDA-A00	2
Flange Bolt (10 x 77 mm)	90167-TZ7-A01	2
Flange Bolt (10 x 24 mm)	90166-TZ7-A01	2
Flange Bolt (14 x 150 mm)	90177-SDA-A00	2
Bolt Washer (8 x 16 mm)	90101-SWA-A00	2
Flange Bolt (12 x 33 mm)	90186-SDA-A00	2
Flange Bolt (10 x 34 mm)	90162-T2A-A00	4
Snap Ring (32 x 2.2 mm)	44319-STX-A01	1
Set Ring (32 x 2.2 mm)	44319-STX-A60	1

REQUIRED MATERIALS – REPAIR PROCEDURE B

Part Name	Part Number	Quantity
Coolant Type 2	OL999-9011A	3
Acura motor oil 0W-20	08798-9073	6

TOOL INFORMATION

Part Name	Part Number	Quantity
Coolant Flush Kit Pump and Filter Set	VSB02C000045	1
9 A/T Pressure Test Kit	VSB02C000046	1
9 A/T Bucket and Hose Set	VSB02C000047	1
9 A/T Adapter and Hardware Set	VSB02C000048	1

NOTE:

- Each dealer was sent one of each of these tools. If you need additional tools, contact the Honda Tool and Equipment Program at 888-424-6857.
- Individual items in the kit and sets are not available separately. You must order the complete kit or set.

Coolant Flush Kit Pump and Filter Set - VSB02C000045



9 A/T Adapter and Hardware Set - VSB02C000048



9 A/T Pressure Test Kit - VSB02C000046

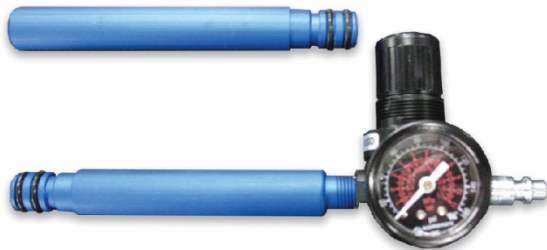

9 A/T Bucket and Hose Set - VSB02C000047



RADIATOR INSPECTION PROCEDURE

If there is a leak in the ATF warmer, the engine coolant will mix with the ATF and result in the customer complaining about one or more of the following symptoms:

- **The vehicle overheats**
- **The transmission shifts poorly**
- **The transmission chirps when shifting**

Look for ATF contamination in the cooling system

Remove the radiator cap and inspect for ATF in the coolant. If there is coolant contamination, the coolant will look brown.

CAUTION: Coolant can be HOT. Use caution before removing the radiator cap.



ATF IN THE COOLING SYSTEM

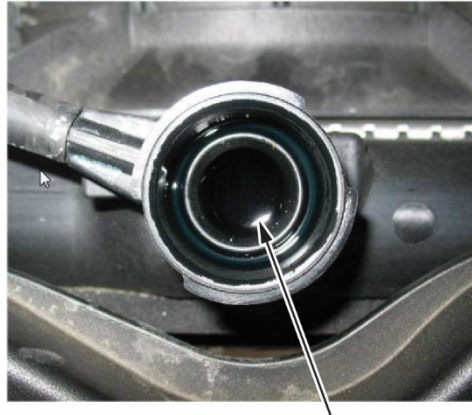

NORMAL COOLING SYSTEM

- Remove some ATF from the level check plug, and inspect for contamination. If the fluids have cross-contaminated, the color will be brown, and the consistency will be similar to a milkshake. Do the ATF WARMER INSPECTION to confirm if a leaking ATF warmer is the cause.
- Not all cases of cross-contamination are visible, so if the customer complains about transmission noise, poor shift quality and/or the engine overheating, even if the coolant/ATF fluid looks OK, do the ATF WARMER INSPECTION.

ATF WARMER INSPECTION PROCEDURE

1. Raise the vehicle on a lift.
2. Remove the splash shield. Refer to the service information.
3. Remove the air cleaner. Refer to the service information.
4. Remove the intake air guide. Refer to the service information.
5. Remove the 12-volt battery. Refer to the service information.
6. Remove the battery box. Refer to the service information.
7. Remove the connector bracket. Refer to the service information.
8. Using commercially-available clamps, pinch off the coolant hoses.

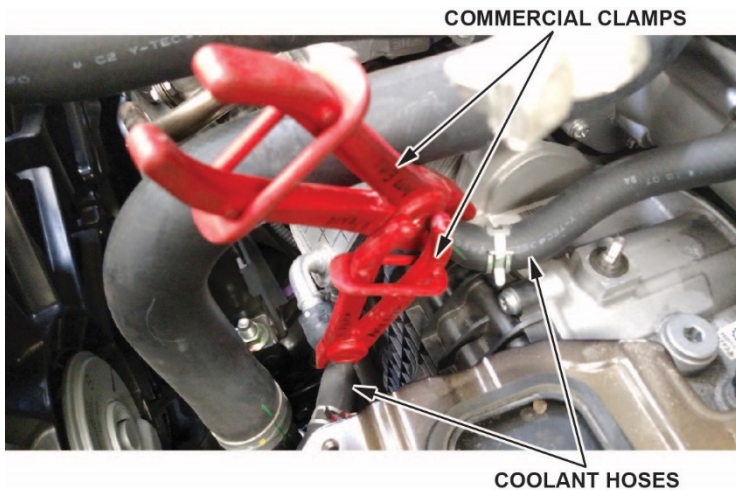

9. Remove the coolant hoses from the transmission warmer.

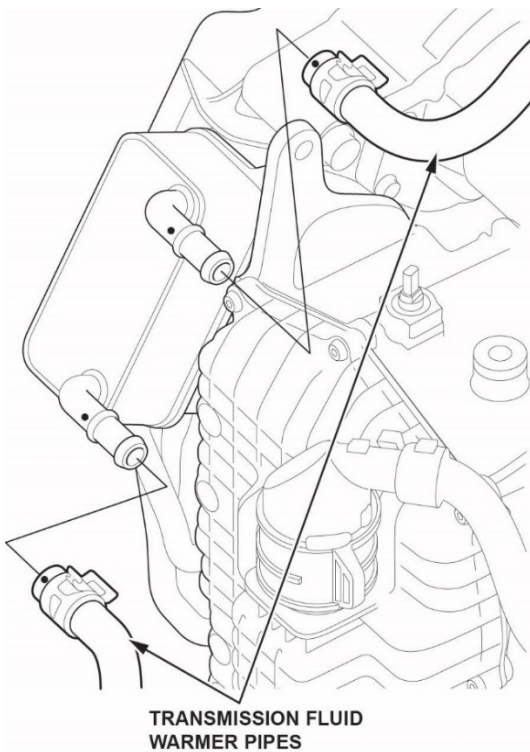

10. Clean the connection points around the transmission fluid warmer pipes.

11. Remove the transmission fluid warmer hoses.

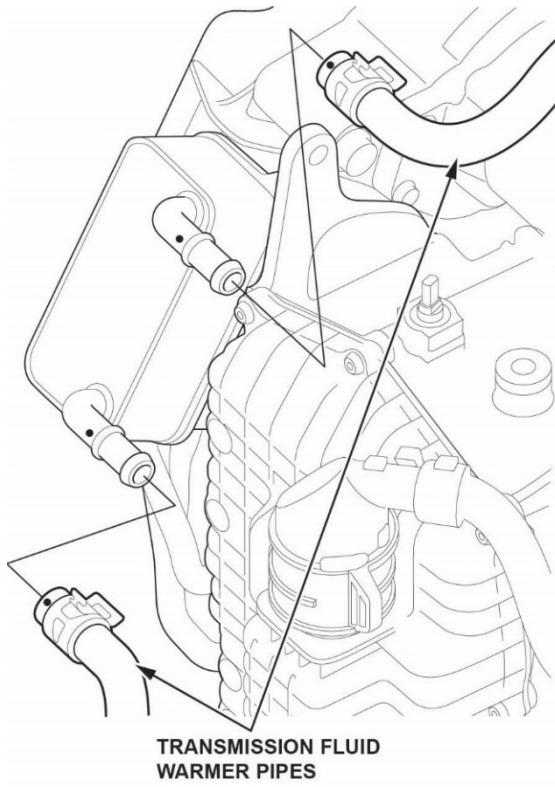

12. Remove the transmission warmer with the fixing plates, and place them on a clean surface.

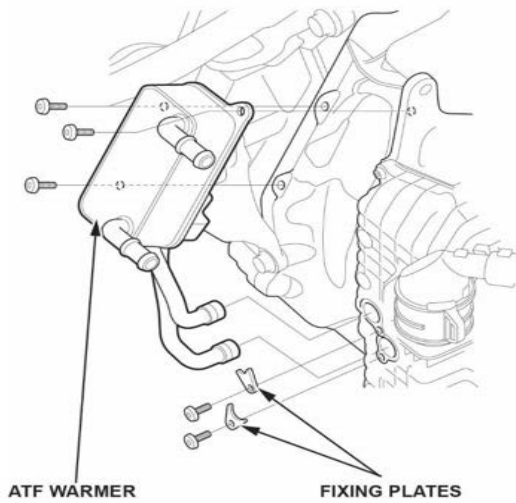

13. Prepare the transmission warmer to check for leaks.

- Remove the original ATF lines.
NOTE: Be careful not to damage the lines as you may reuse them.
- Install the pressure check tool as shown with the fixing plates, and torque the bolts to **10 N·m (7 lb-ft)**.
- Fill a bucket with warm water.
- Connect shop air to pressurize the warmer, and adjust the pressure check tool to **70 PSI**.

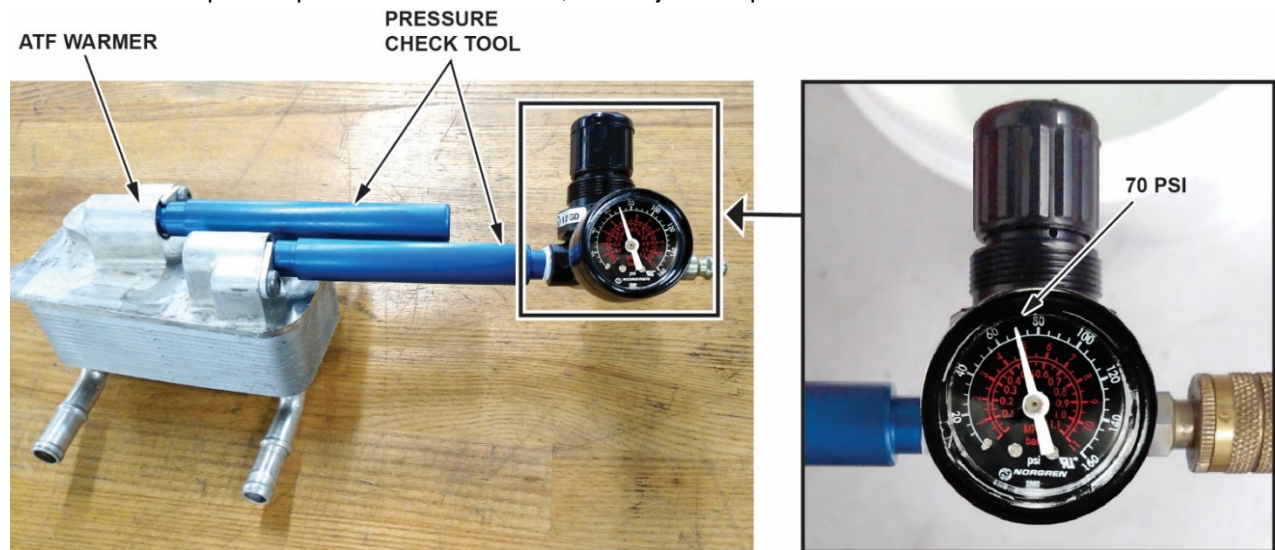

14. Check the transmission warmer for leaks by submerging the warmer completely under the water and watching for bubbles.

NOTE: Some bubbles are normal when the transmission warmer is first submerged and will come to a stop. If there is a leak, there will be a steady stream of bubbles coming from the transmission warmer.

- **If there are no bubbles** coming from the warmer, the 9-speed transmission warmer is OK. **Go to step 15 to install the original warmer** with new O-rings. Submit a claim for the warmer inspection only, then continue with normal troubleshooting to resolve the original customer complaint.
- **If there are bubbles**, take photos (see Photos) and check to see if the vehicle also overheated by checking the customer responses on the RO.
 - If the transmission warmer leaks, but the vehicle did not overheat, go to [REPAIR PROCEDURE A](#).
 - If the transmission warmer leaks, and the vehicle did overheat, go to [REPAIR PROCEDURE B](#).



Photos

If there are bubbles because of a leaking transmission warmer, take photos of the bubbles during the pressure test, the transmission warmer serial number, and the VIN.

- The pressure test

ATF WARMER PRESSURE TEST



Take this photo:

BUBBLES

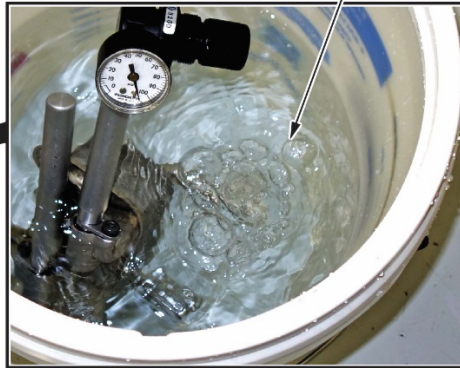

- The transmission warmer serial number

TRANSMISSION WARMER

Take this photo:

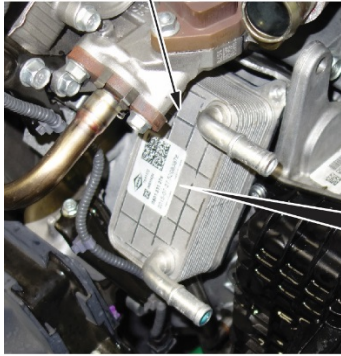

- VIN

VIN LABEL



Take this photo:



NOTE:

- These photos must be submitted with any warranty claim where the transmission is replaced
- Make sure you install the leaking transmission warmer on the original transmission to be returned to the remanufacturing facility. Any transmission replacement claims that do not have the leaking warmer installed on the returned transmission may be subject to debit.
- Any transmission replacement claims that do not include the required photos may be subject to debit.

Unacceptable Photos

Photos must correspond to the warranty claim submittal standards. Photos may be rejected for the following reasons:

- Out of focus and unreadable
- Too small of a file size
- Too dark

15. Remove the two ATF lines from the transmission warmer, then remove the 8 O-rings on the pipes by gently pushing the O-rings off with your fingers.

NOTE:

- Do not use picks or screwdrivers to remove the O-rings as you may damage the sealing surface.

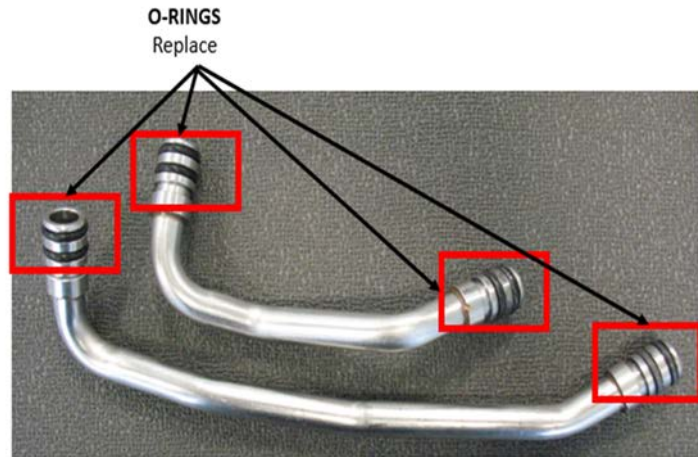

16. Clean the pipes, then install 4 new O-rings.

NOTE: Make sure your hands or gloves are clean to avoid contaminating the O-rings.

17. Coat the O-rings with ATF 3.1.

18. Install the original ATF warmer pipes onto the original transmission warmer using the fixing plates. Torque the bolts to **10 N·m (7 lb-ft)**.

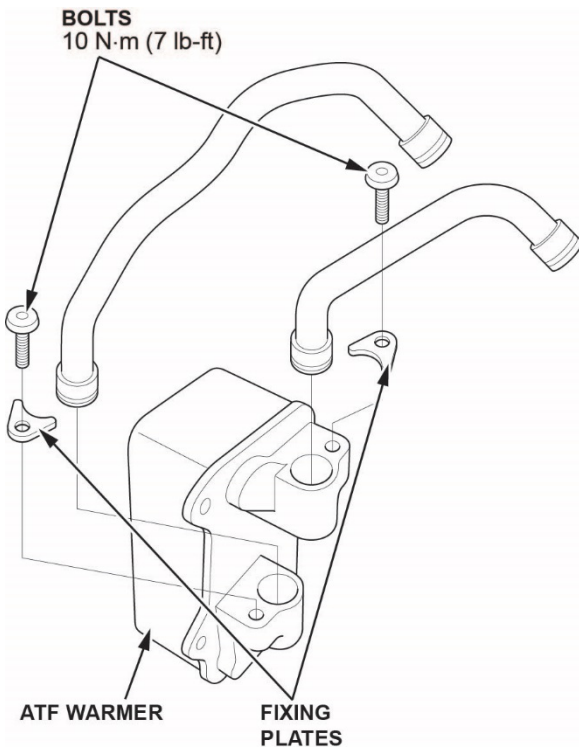

19. Install the transmission warmer to the transmission. Install the ATF warmer pipes using fixing plates. Torque the bolts to **10 N·m (7 lb-ft)**.

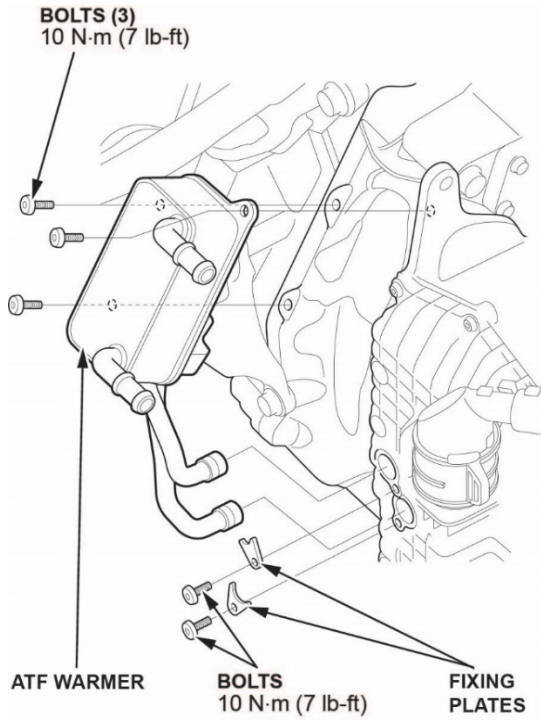

20. Connect the water bypass hoses. Make sure you align the paint marks on the ATF warmer lines with the paint marks on the water bypass hoses as shown. Secure the water bypass hoses with the clamps.

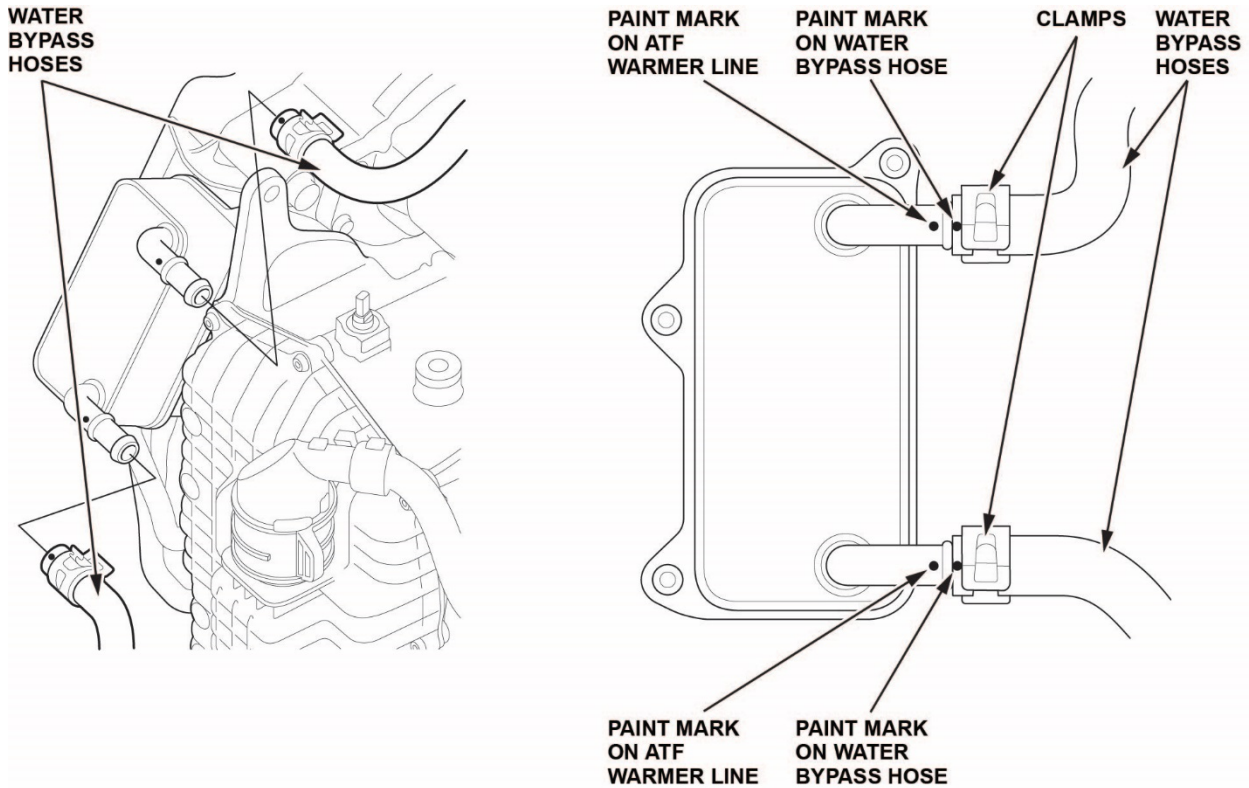

21. Install the connector bracket.
22. Install the battery box and the 12-volt battery.
23. Install the intake air guide and the air cleaner.
24. Fill the engine with coolant.
25. Check the ATF, and adjust as needed. Refer to the service information.

NOTE: Make sure you use Honda ATF Type 3.1 if you have to add fluid. Using the wrong ATF can affect shift quality.

26. Check for any ATF or coolant leaks.
27. Install the splash shield.

REPAIR PROCEDURE A

NOTE:

- Use this procedure only if the transmission warmer failed the pressure test and the engine did not overheat. If the engine did overheat, go to REPAIR PROCEDURE B.
- Fill the flush work sheet out (see page 35), and attach it to the RO.

1. Remove the transmission.

Engine and Heater Core Flush Procedure

2. Disconnect the upper and lower radiator hoses at the engine.

DISCONNECT:

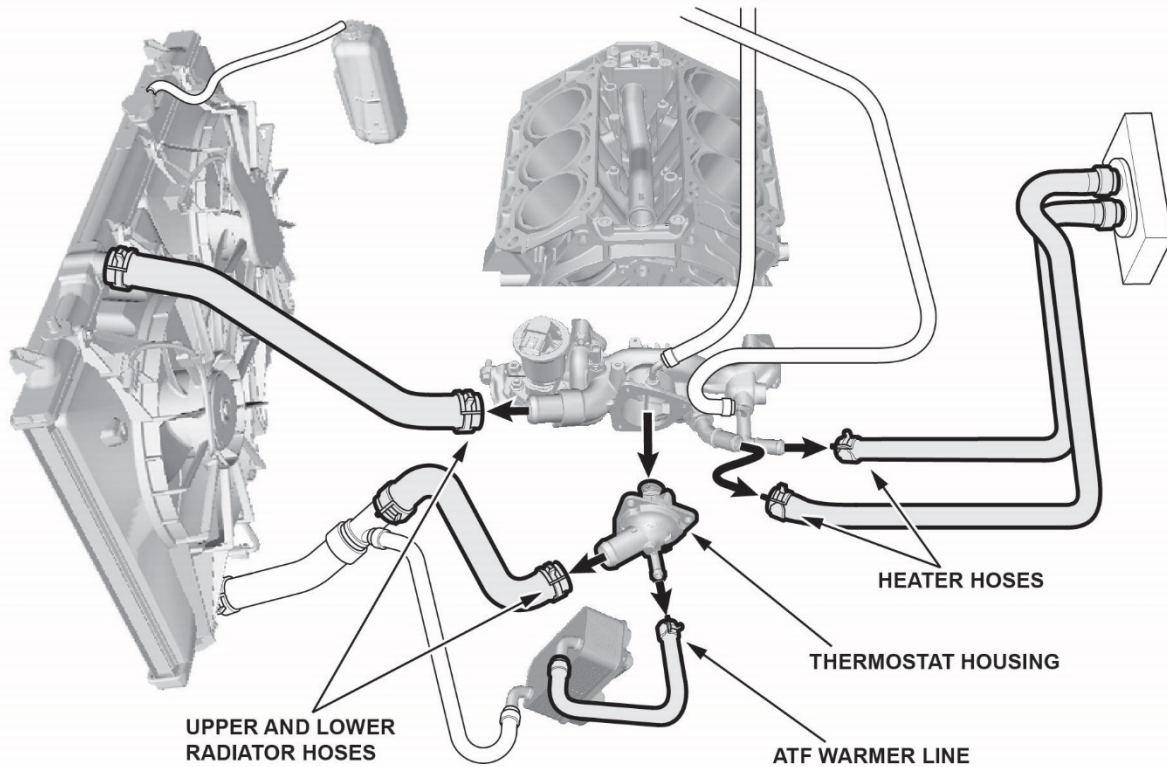

3. Disconnect the two heater hoses at the engine.
4. Disconnect the ATF warmer line (coolant).
5. Remove the thermostat housing.

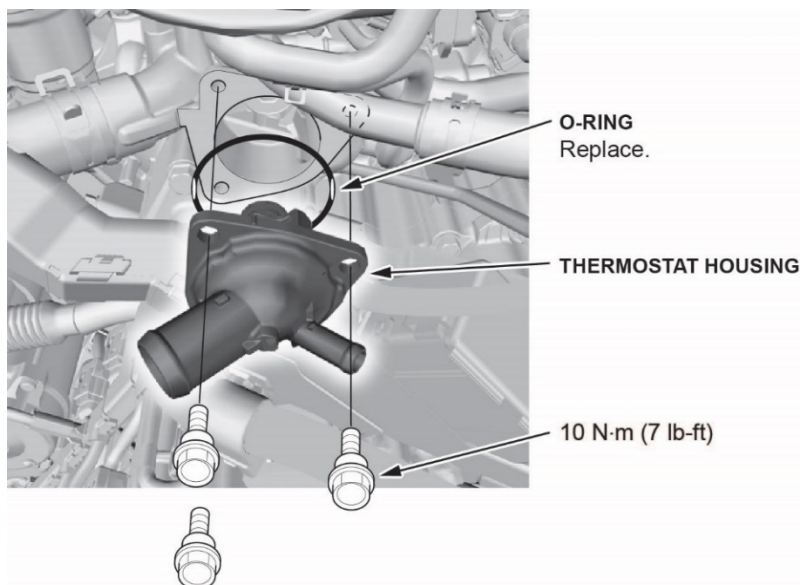

6. Remove the thermostat from the housing using a 32 mm socket. Push in on the thermostat, and twist the socket. Once the thermostat has released from the housing, remove the thermostat.

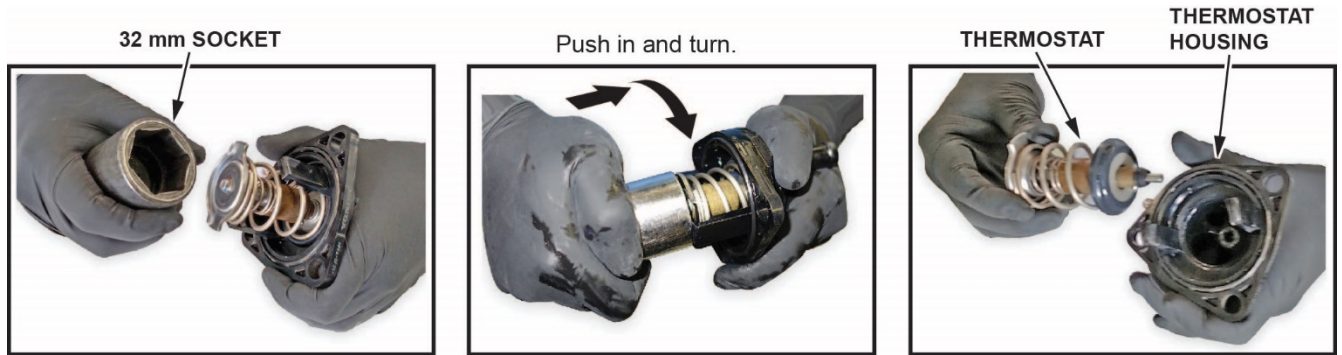

7. Install the green rubber plug from the coolant flush kit into the thermostat water jacket as shown. To prevent the plug from falling into the water passage, cover the opening with a shop towel.

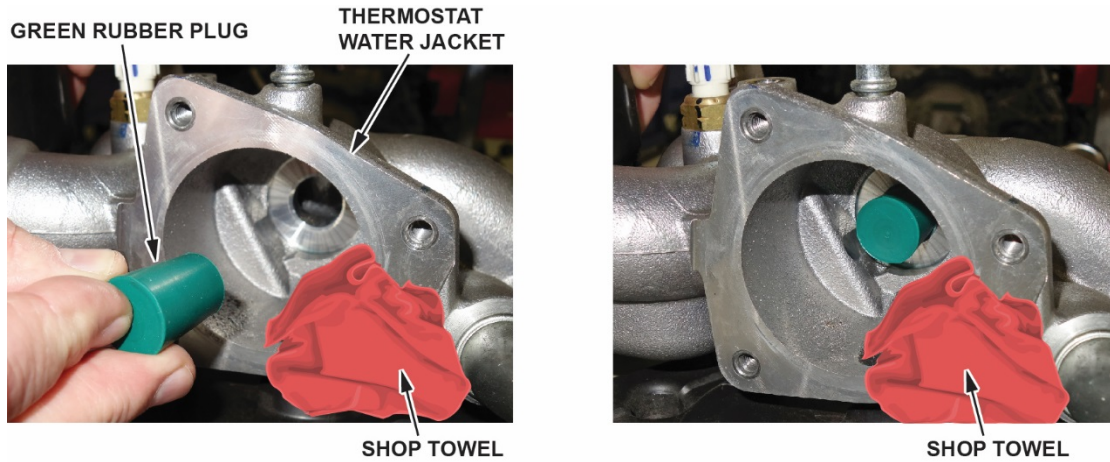

8. Remove the shop towel, and install the thermostat housing without the thermostat.

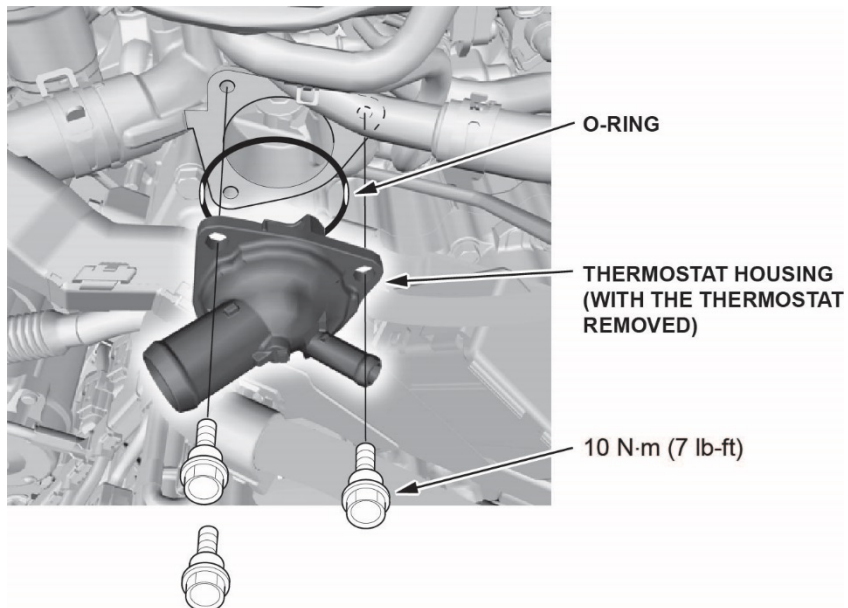

9. Using the three colored plugs from the flush kit, cap off both heater hoses and the ATF transmission warmer line as shown.

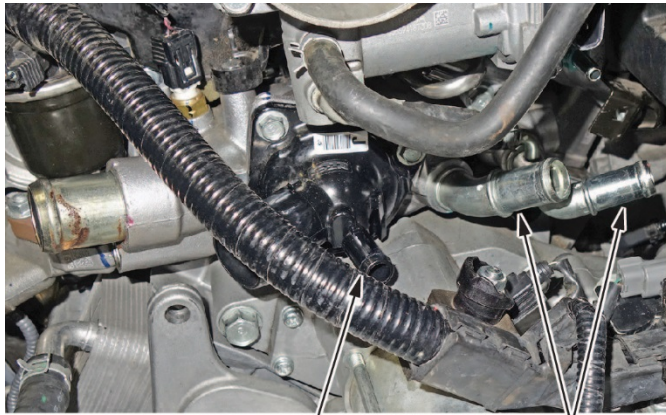

ATF TRANSMISSION
WARMER LINE

HEATER HOSES

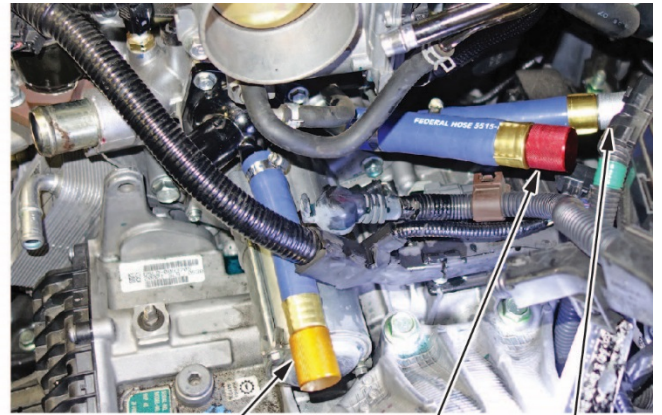

YELLOW PLUG
(ATF WARMER LINE)

RED PLUG
(HEATER
HOSE)

SILVER PLUG
(HEATER
HOSE)

10. Using commercially-available clamps, clamp the throttle body coolant lines as shown.

Clamp both of the throttle body coolant lines.

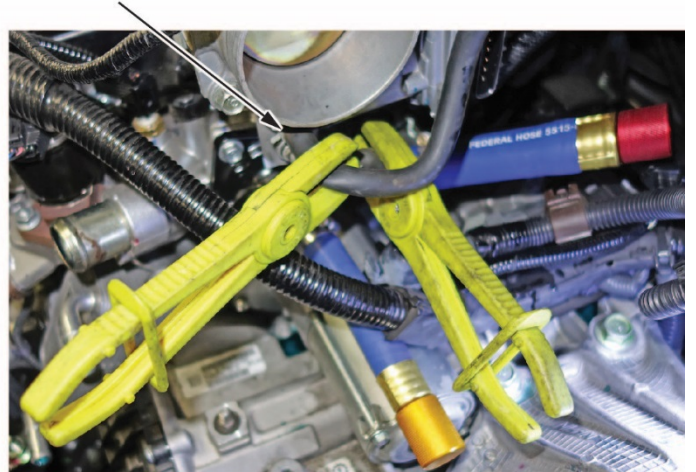

11. From the bucket marked SUPPLY, remove the lid and install the large (1.5 in.) return hose with the T-fitting through the hole in the lid as shown.



ENGINE RETURN HOSE

T-FITTING

SUPPLY BUCKET

12. Install the thermostat adaptor to the pump outlet hose.

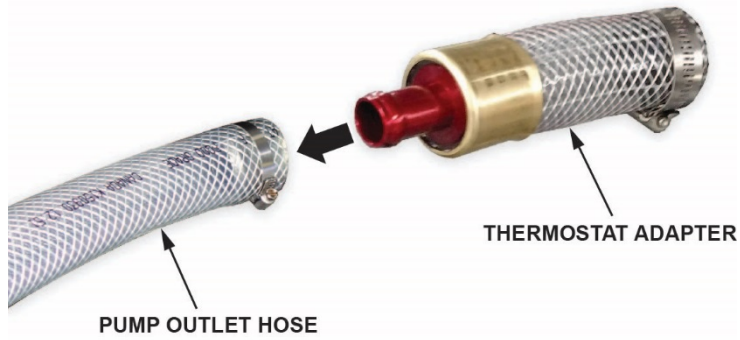

13. Install the pump outlet hose onto the thermostat housing.



14. Install the return hose onto the water passage as shown, then fill the bucket with 4.5 gallons of fresh water, and install the lid.

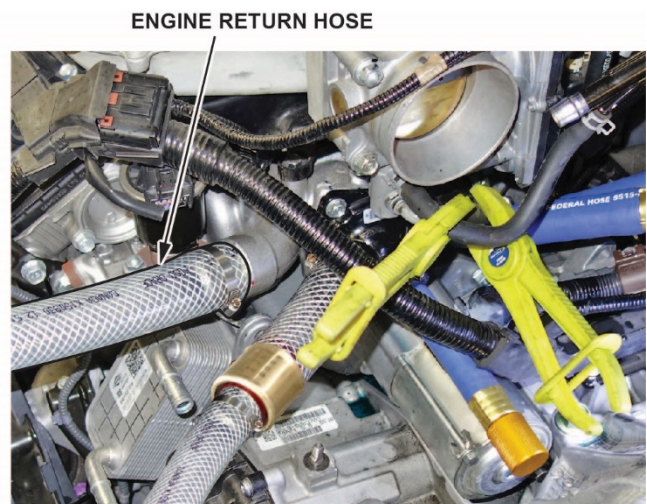

15. Install the pump inlet line to the SUPPLY bucket lid as shown.

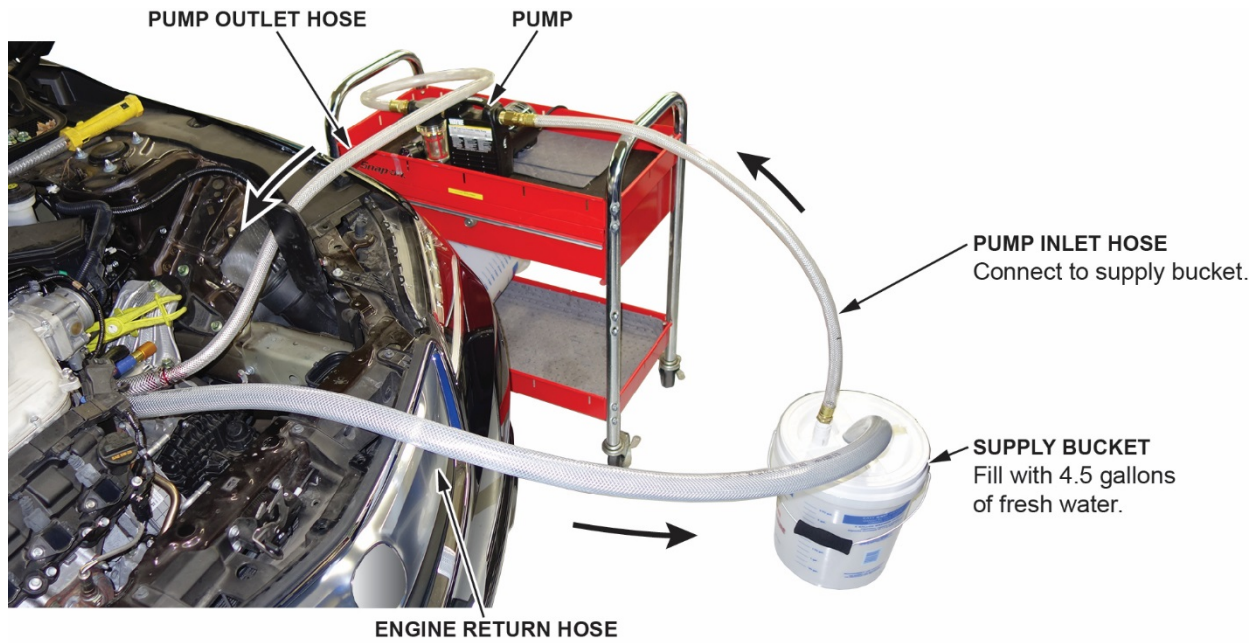

16. Turn on the pump, and let it run for 10 minutes.

NOTE: If this is the first time using the pump, remove the priming plug, fill the pump with clean water, then install the plug.



17. After 10 minutes, turn the pump off and dump all the contents of the SUPPLY bucket into the waste coolant container. Wipe off any oil residue from the bucket, refill the bucket with water, then repeat the flush 4 more times (50 minutes total time flushing with water).

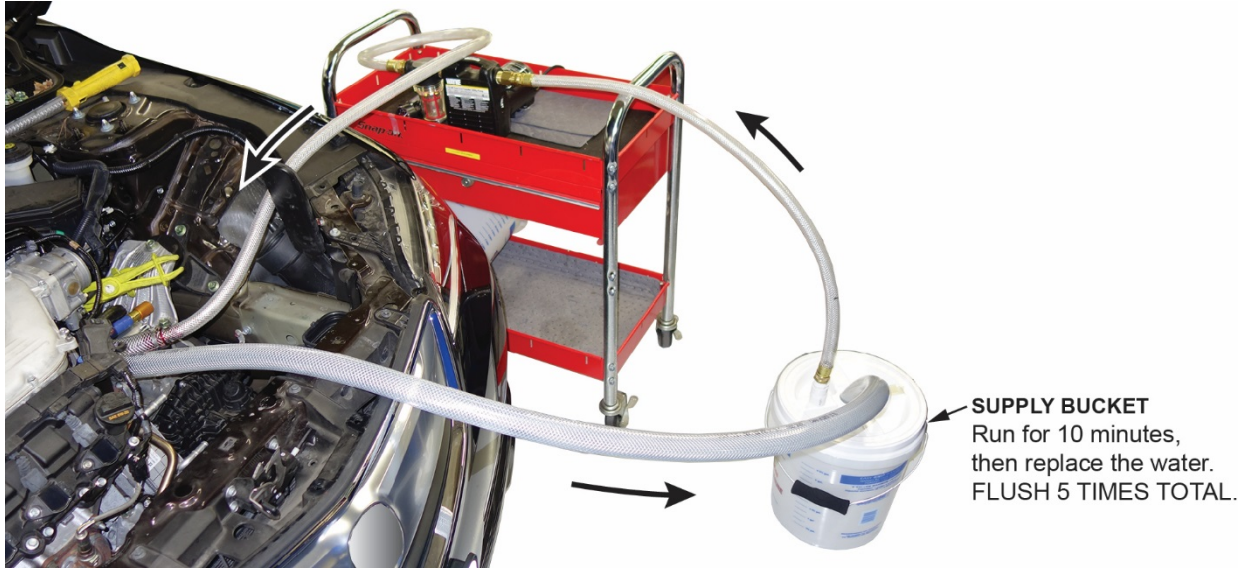

18. Substitute the water for coolant (OL999-9011A), and run the pump for 10 minutes to circulate the fluid.

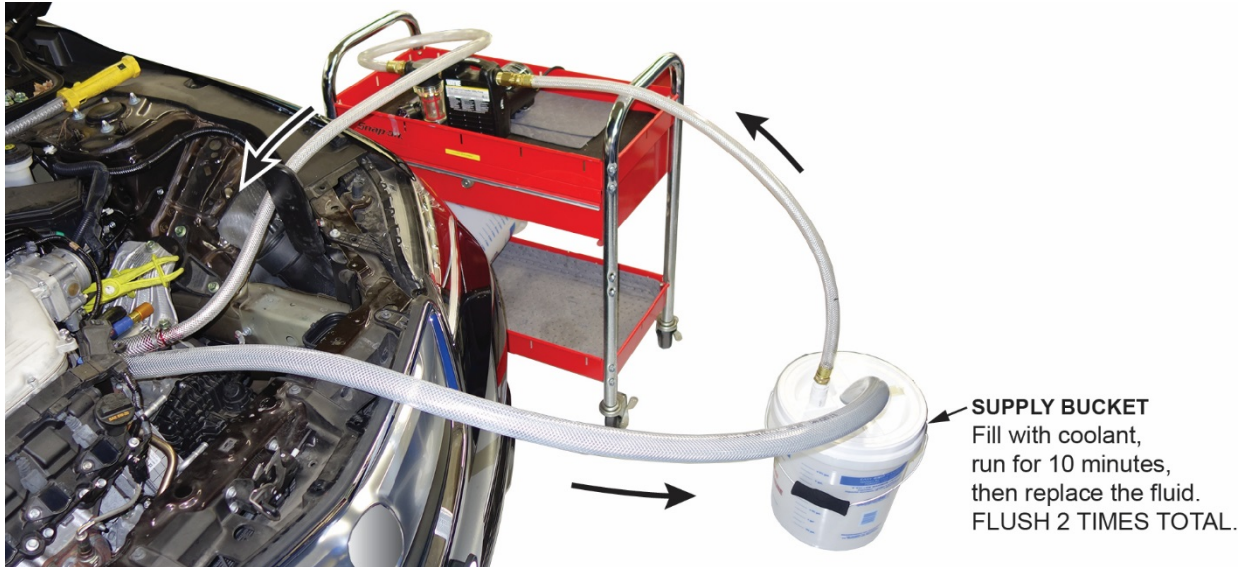

19. After 10 minutes, turn the pump off and dump all the contents of the SUPPLY bucket into the waste coolant container. Refill the SUPPLY bucket with coolant, and run the pump for 10 minutes.

20. Disconnect the pump outlet line from the engine, and remove the thermostat adaptor. Replace the outlet adaptor with the 0.75 in. heater hose adaptor.

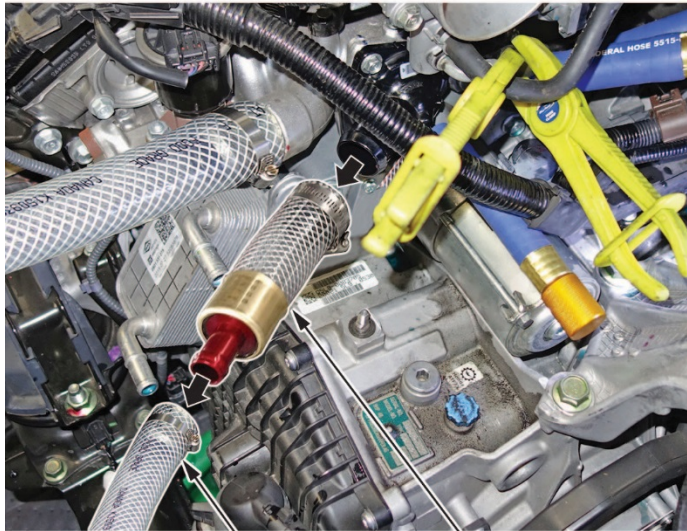

PUMP OUTLET HOSE
Disconnect.

THERMOSTAT ADAPTER

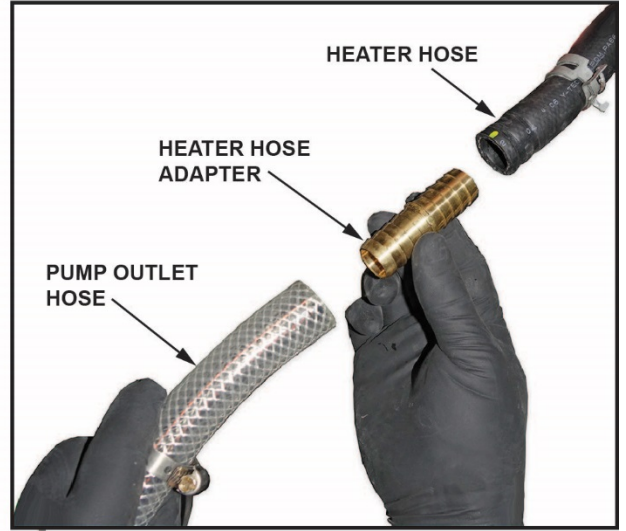

HEATER HOSE

HEATER HOSE ADAPTER

PUMP OUTLET HOSE

21. Remove the thermostat cover, remove the green rubber plug, and return it to the coolant flush kit. To prevent the plug from falling into the water passage, cover the passage with a shop towel.

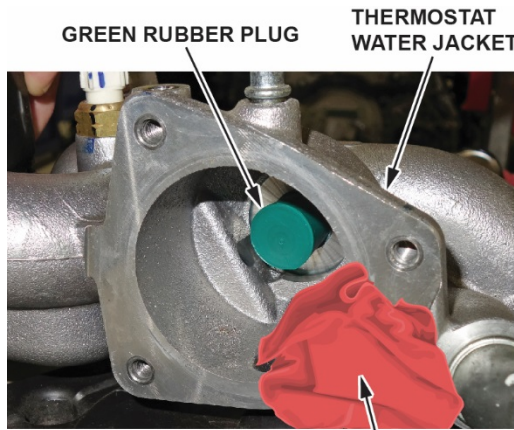

GREEN RUBBER PLUG

THERMOSTAT WATER JACKET

SHOP TOWEL

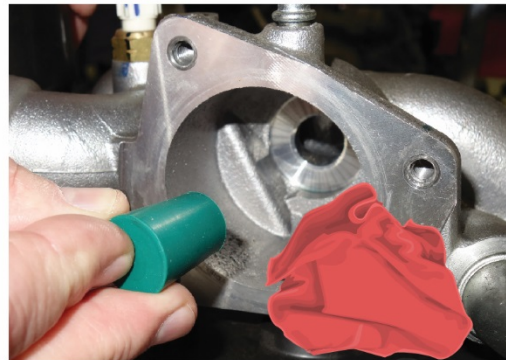

22. Connect the pump outlet hose to the heater hose as shown.

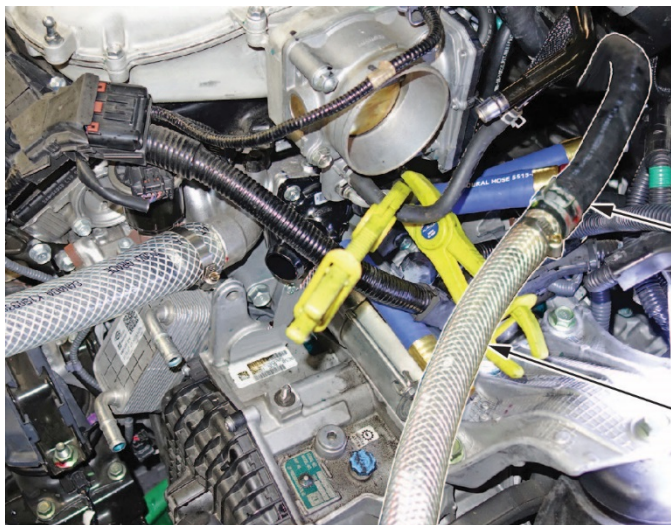

HEATER HOSE

PUMP OUTLET HOSE

23. Install the heater core return hose through the DUMP bucket lid.



24. Attach the heater core return hose to the heater hose as shown.

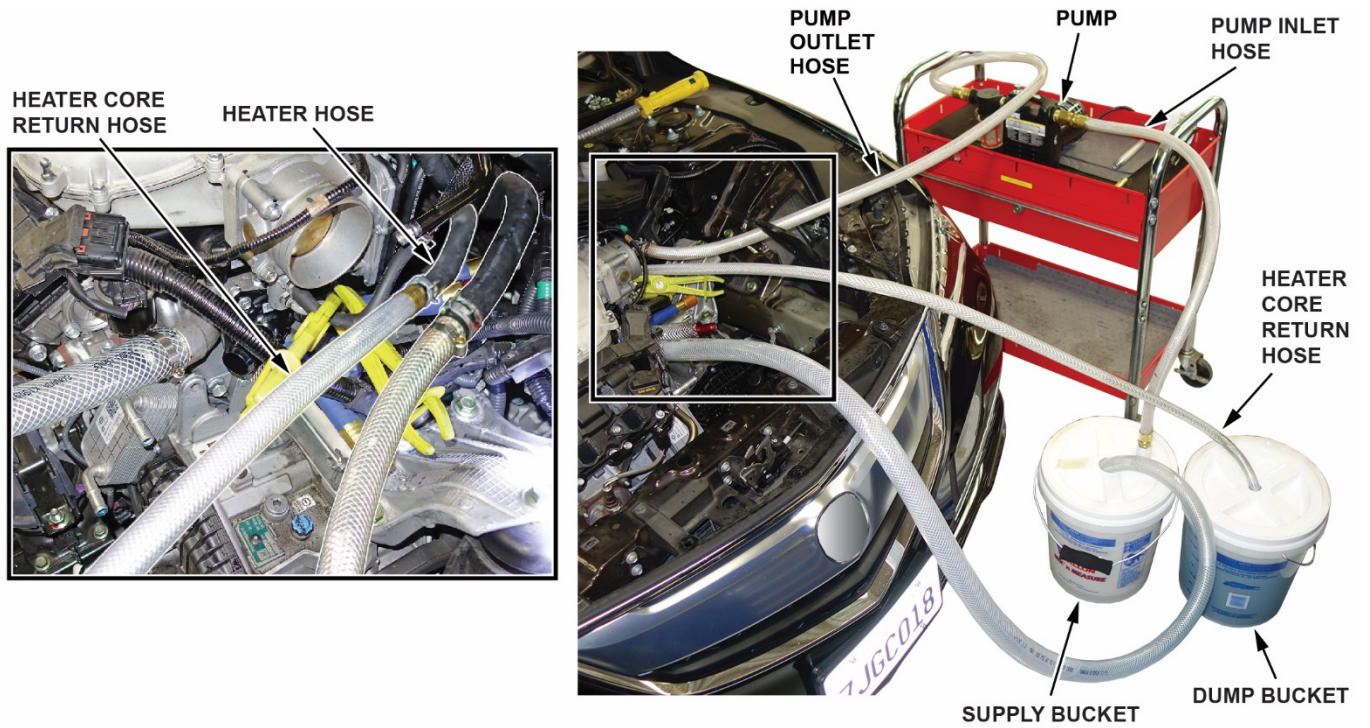

25. Fill the SUPPLY bucket with water, and run the pump until the SUPPLY bucket is empty.

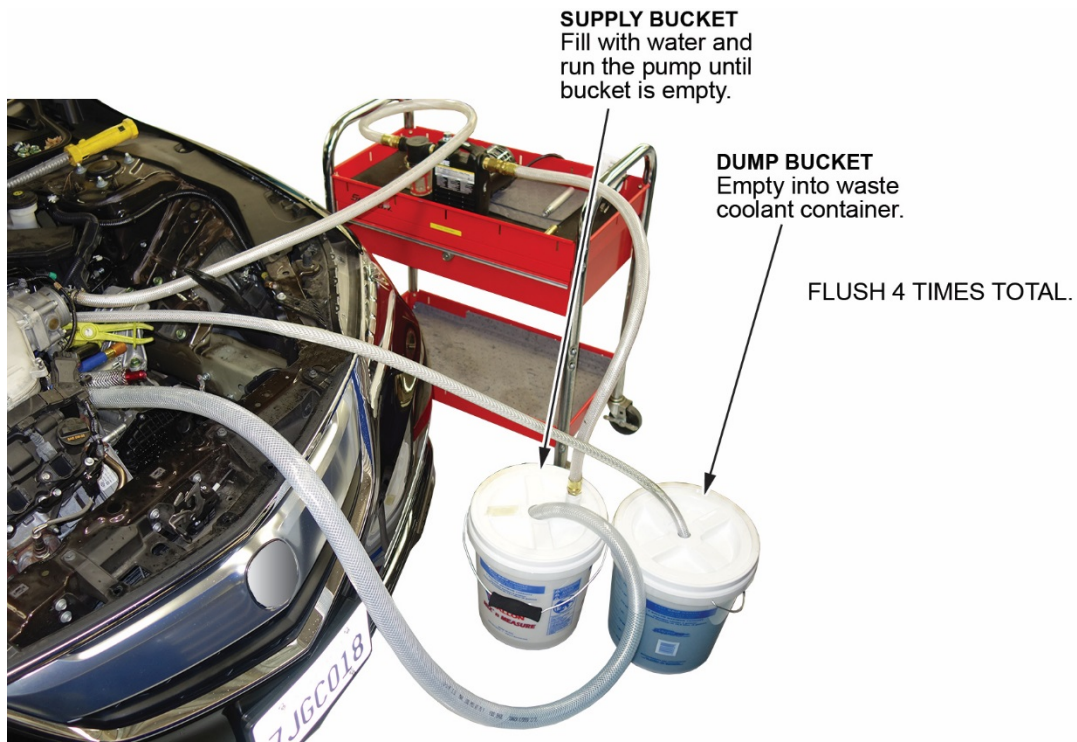

26. Empty the DUMP bucket into the waste coolant container.

27. Repeat the flush (steps 25 and 26) 3 more times.

28. Empty the DUMP bucket into the waste coolant container and wipe off any oil residue from the bucket.

29. Remove the pump and return hoses, and the three colored plugs from the vehicle.

Reassemble Vehicle

30. Install the new remanufactured transmission. Refer to the service information.

31. Replace the radiator, the 10 indicated coolant hoses, thermostat, coolant reserve tank and hoses, and the 2 ECT sensor (1 and 2) O-Rings. Refer to the image for the location of all the components.

NOTE:

- **Make sure to remove the rubber plug that was installed in the thermostat water jacket and return it to the flush kit.**
- **When refilling the cooling system after the flush is complete, some oil may be present in the cooling system. Thorough testing has shown the amount left over after the flush procedure is within acceptable limits provided the flush procedure was followed completely.**

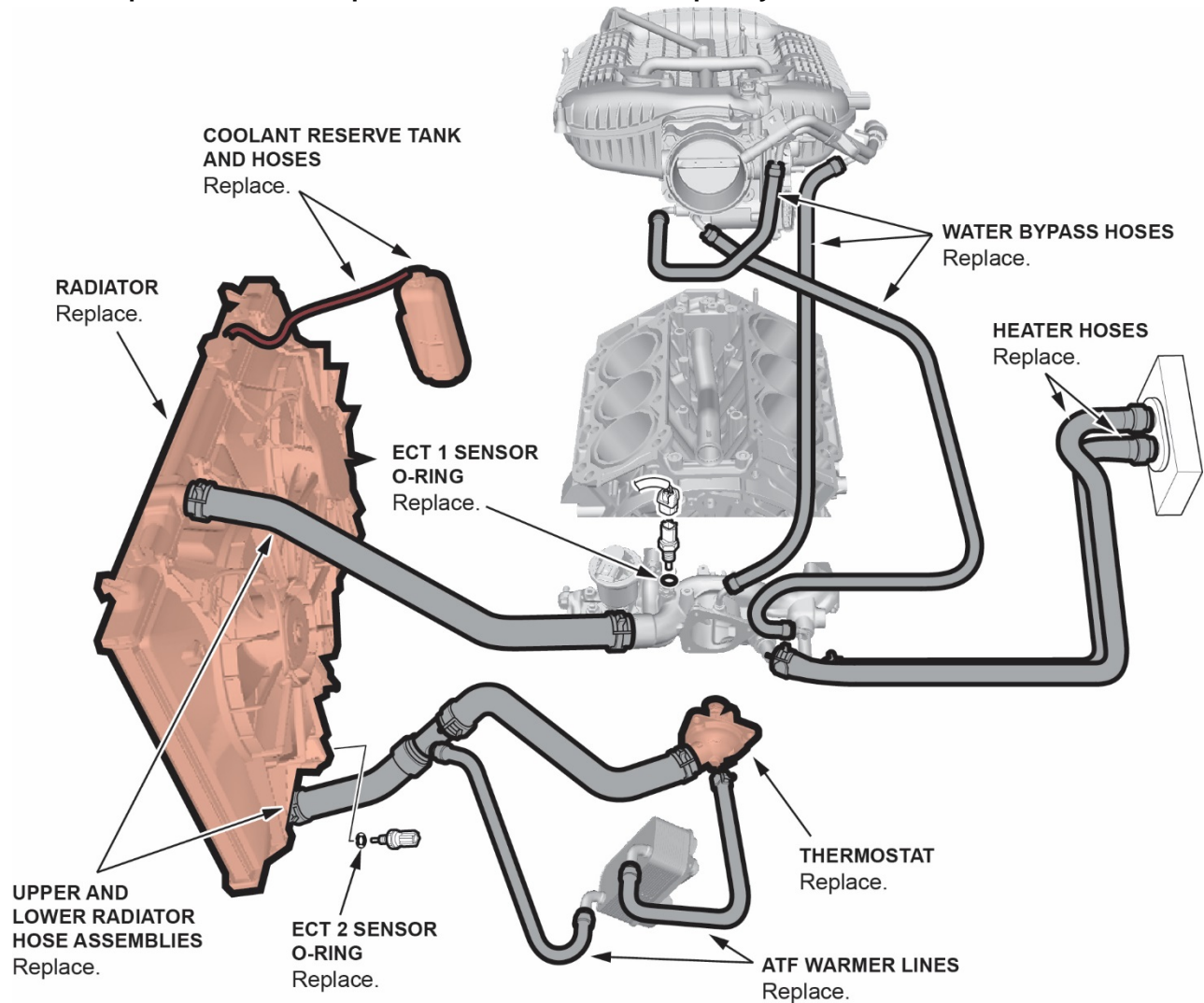

32. To ensure proper shift quality, update the TCM and PCM as necessary, then do the PCM idle learn, teach-in (Hydraulic Pressure Characteristic Calibration), and adaptation (see Tech2Tech listed below). Refer to the service information.

PCM

Trim	Program IN (or later)	Program P/N (or later)
2015-16 Base/Tech	J23050	37805-5J2-3050
2015-16 ADV	J23060	37805-5J2-3060
2015-16 Tech AWD	J23070	37805-5J2-3070
2015-16 ADV AWD	J23090	37805-5J2-3090

PCM

Trim	Program IN (or later)	Program P/N (or later)
2015–16 2WD Base/Tech	J4A590	28101-5J4-A590
2015–16 2WD Advance	J4A690	28101-5J4-A690
2015–16 AWD Base/Tech	L9A700	28101-5L9-A700
2015–16 AWD Advance	L9A690	28101-5L9-A690

- Automatic Transmission Removal and Installation
- [Tech2Tech “Power Up a One-Push Start Vehicle with the i-HDS – With Replaced Components”](#)
- [Tech2Tech “9-Speed Transmission or TCM Replacement Procedure”](#)

33. Give your warranty clerk the photos and RO. For the warranty claim to be paid, the **three photos** must be included in the warranty claim. See ATTACHING PHOTOS TO A CLAIM for information about attaching photos to warranty claims.

REPAIR PROCEDURE B

NOTE:

- Use this procedure only if the transmission warmer failed the pressure test and the engine overheated. If the engine did not overheat, go to REPAIR PROCEDURE A.
 - Fill in the heater core part of the flush work sheet out (see page 35), and attach it to the RO.
1. Remove the engine and transmission assembly. Refer to the service information.

Heater Core Flush Procedure

2. Connect the pump to the SUPPLY bucket.

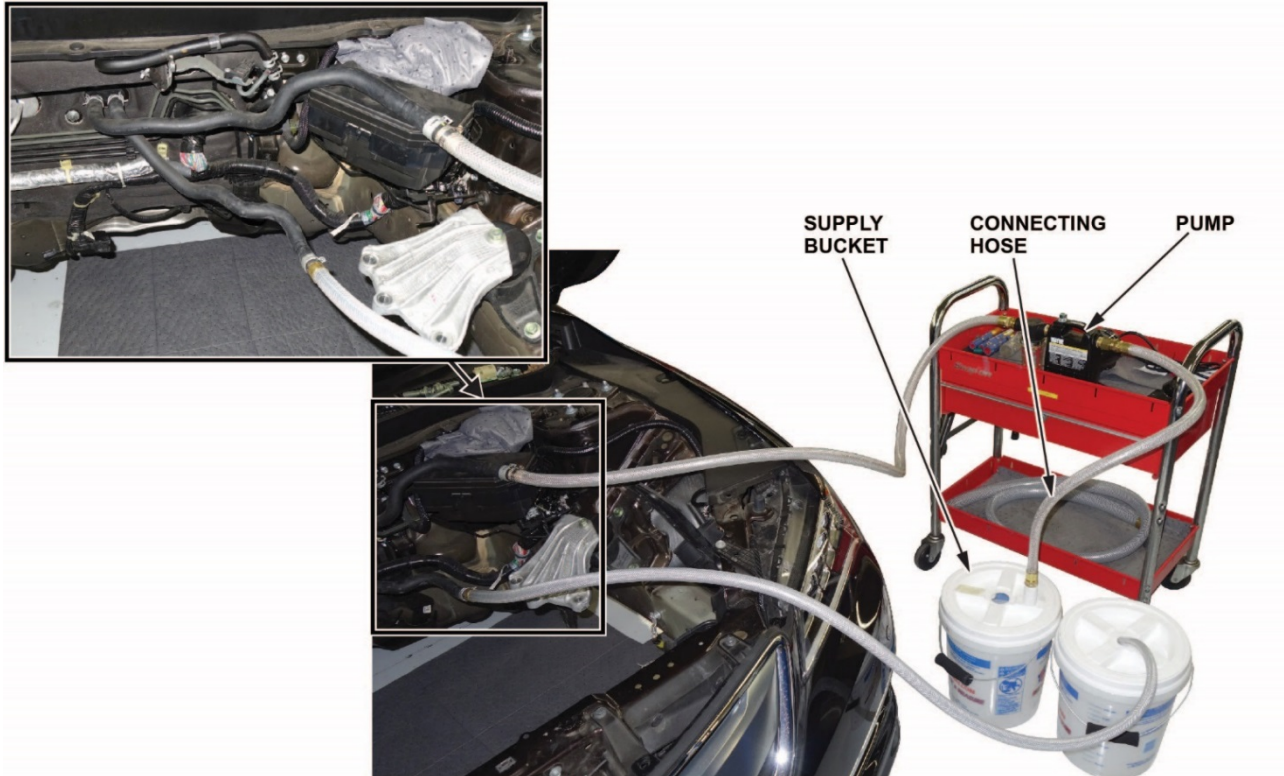

3. Make sure the 0.75 in. heater hose adaptor is installed on the pump outlet hose, then connect the pump outlet hose to the heater hose as shown.

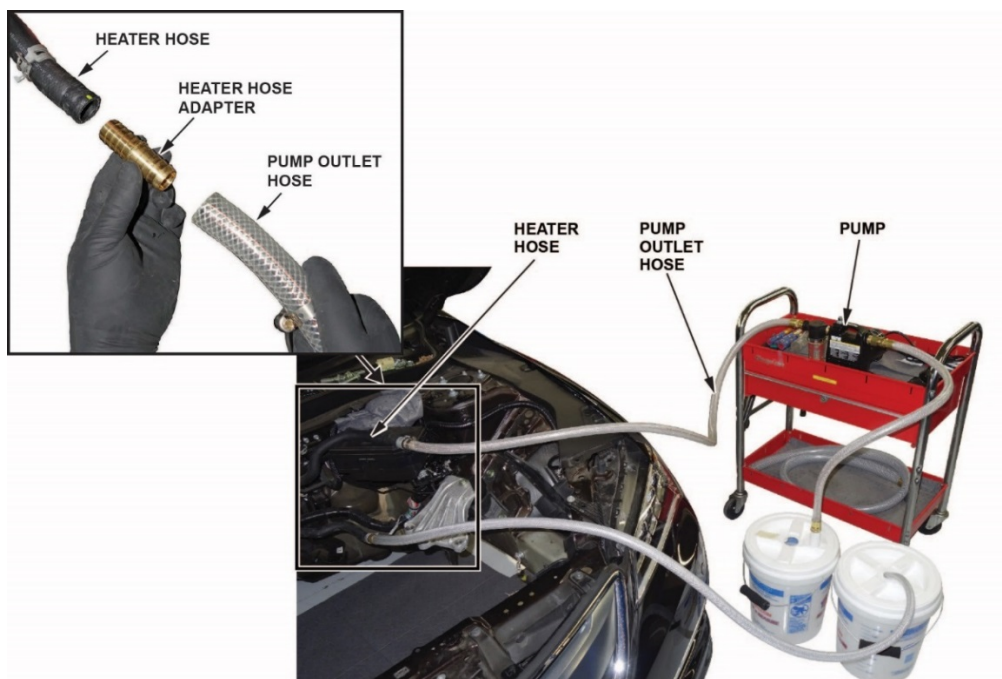

4. Install the return hose through the DUMP bucket lid, then install the lid on the bucket.

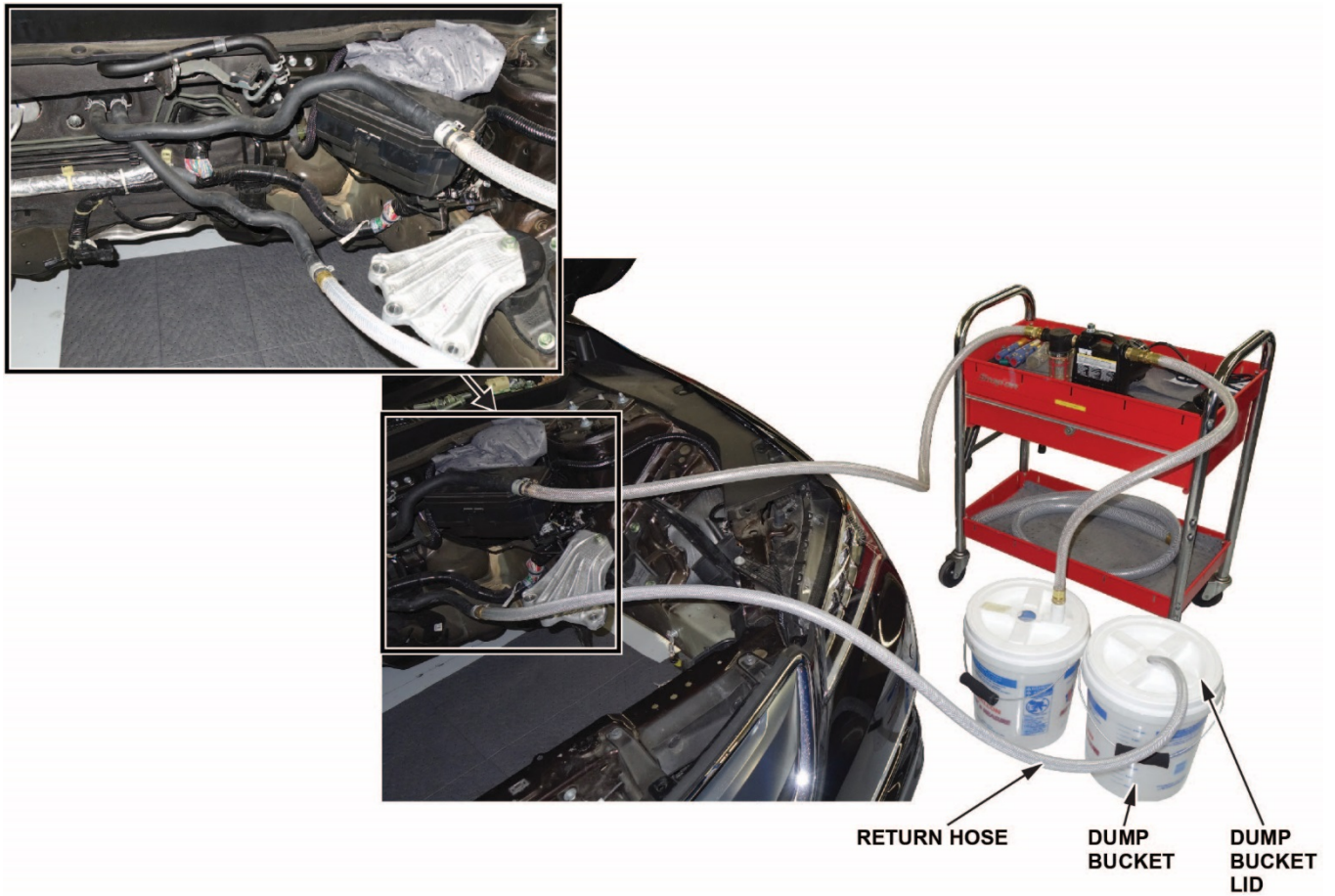

5. Attach the return hose to the heater hose as shown.

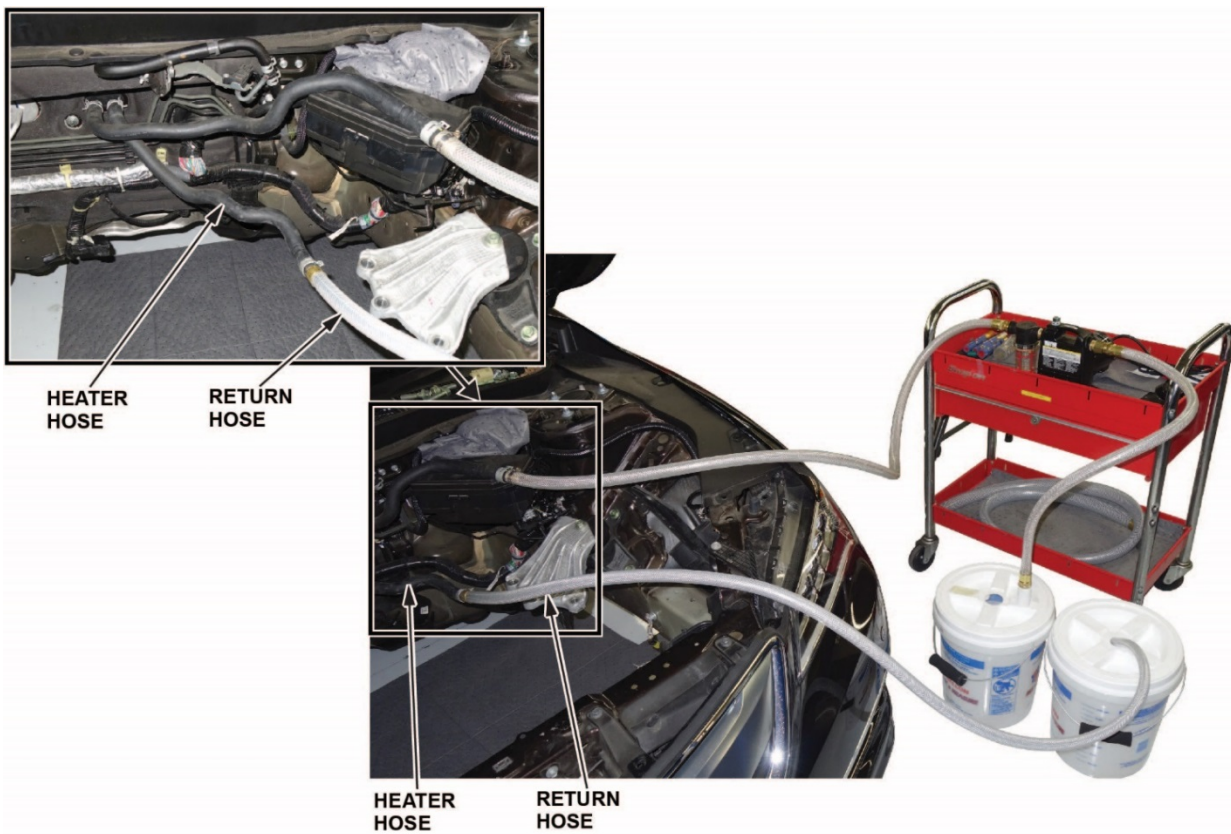

6. Fill the SUPPLY bucket with water, and run the pump until the SUPPLY bucket is empty.

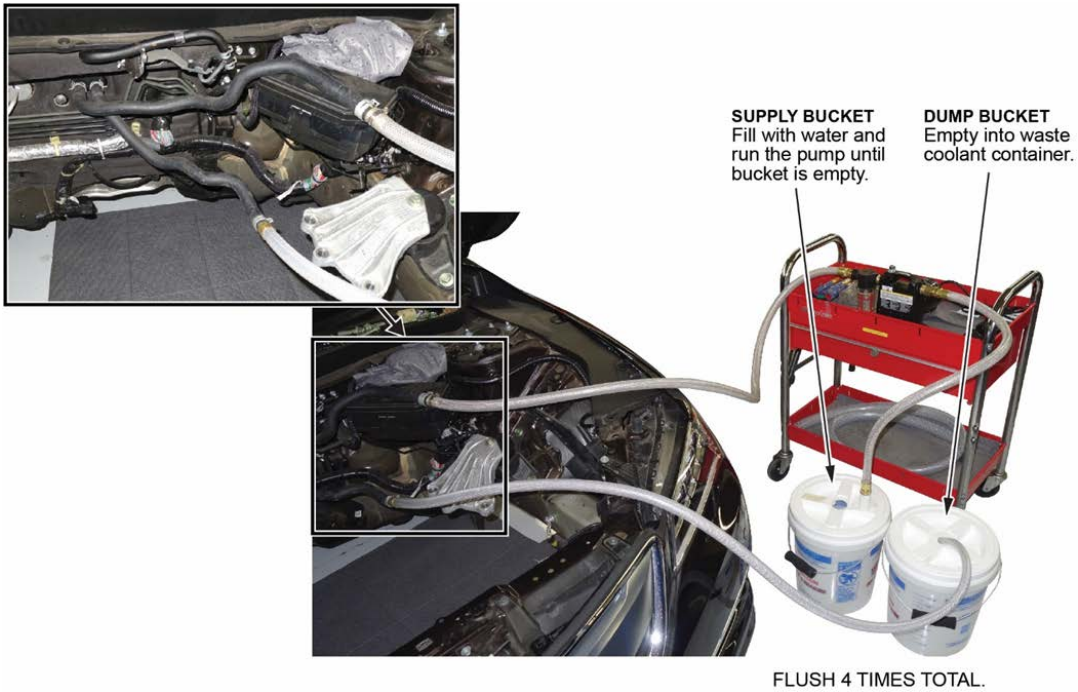

NOTE: If this is the first time using the pump, remove the priming plug, fill the pump with clean water, then install the plug.



7. Empty the DUMP bucket into the waste coolant container.
8. Repeat the flush 3 more times.
9. Empty the DUMP bucket into the waste coolant container, and wipe off any oil residue from the bucket.
10. Remove the pump and return hose from the vehicle.

Reassemble Vehicle

11. Install a new short block, the water connecting pipe, the water passage, new cylinder heads, and a new remanufactured transmission.
12. Replace the radiator, the 10 indicated coolant hoses, the thermostat, the water passage and water connecting pipe, the coolant reserve tank, the 2 ECT sensor (1 and 2) O-Rings, and the coolant reserve tank and hoses. Refer to the image for the location of all the components.

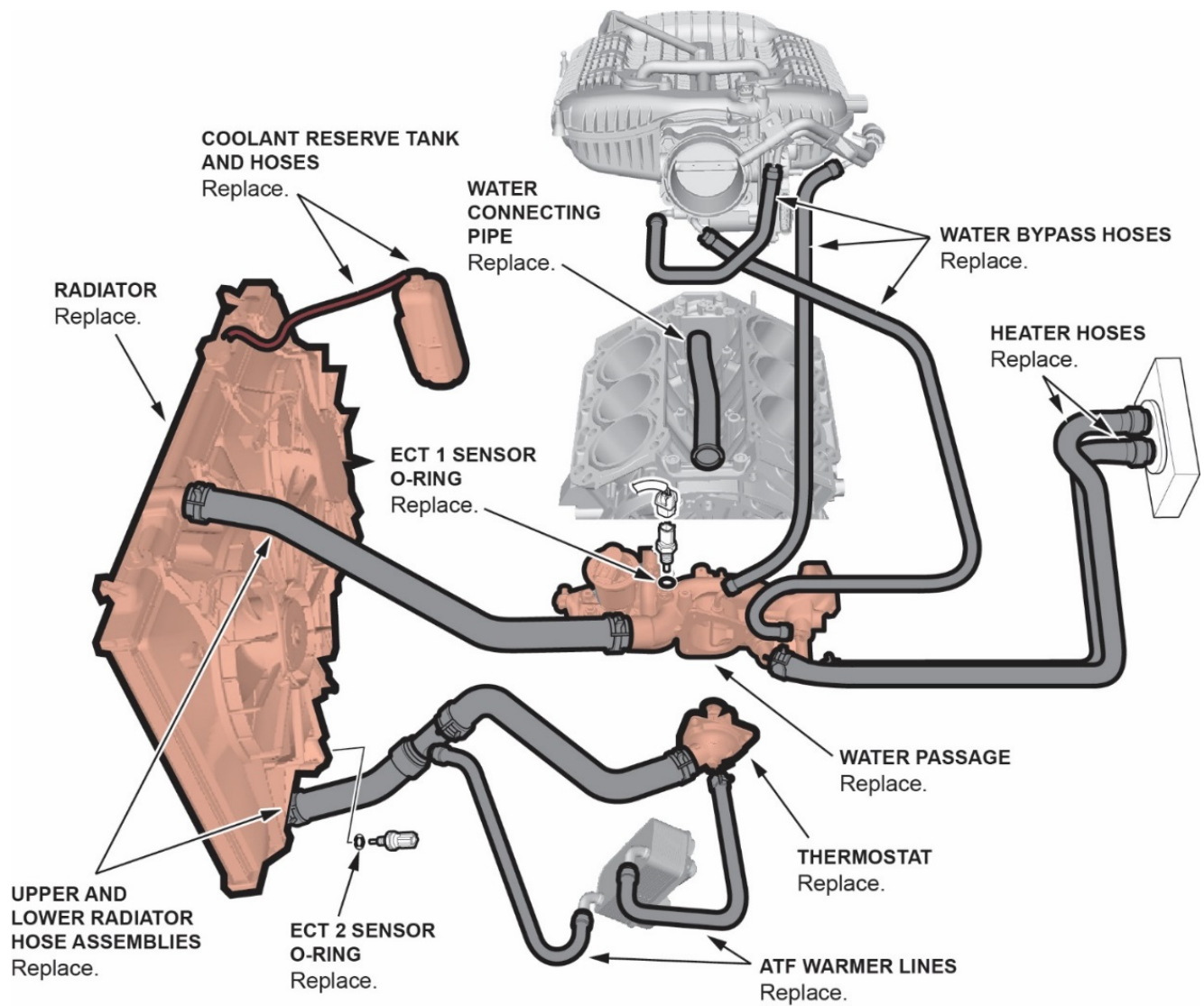

13. To ensure proper shift quality, update the TCM and PCM as necessary, then do the PCM idle learn, teach-in (Hydraulic Pressure Characteristic Calibration), adaptation (see Tech2Tech listed below), and CKP-pattern learn. Refer to service information.

PCM

Trim	Program IN (or later)	Program P/N (or later)
2015-16 Base/Tech	J23050	37805-5J2-3050
2015-16 ADV	J23060	37805-5J2-3060
2015-16 Tech AWD	J23070	37805-5J2-3070
2015-16 ADV AWD	J23090	37805-5J2-3090

TCM

Trim	Program IN (or later)	Program P/N (or later)
2015–16 2WD Base/Tech	J4A590	28101-5J4-A590
2015–16 2WD ADV	J4A690	28101-5J4-A690
2015–16 AWD Base/Tech	L9A700	28101-5L9-A700
2015–16 AWD ADV	L9A690	28101-5L9-A690

- Automatic Transmission Removal and Installation
- [Tech2Tech "Power Up a One-Push Start Vehicle with the i-HDS – With Replaced Components"](#)
- [Tech2Tech "9-Speed Transmission or TCM Replacement Procedure"](#)

14. Give your warranty clerk the digital photos and RO. For the warranty claim to be paid, the **three photos** must be included in the warranty claim. See ATTACHING PHOTOS TO A CLAIM for information about attaching photos to warranty claims.

END

VIN _____
RO _____

Flush Work Sheet.

(Check each box when completed.)
(Attach to the RO.)

ENGINE FLUSH

Prime pump.

Fill Supply bucket with 4.5 gallons of plain water flush 5 times wiping the bucket out between each flush.

1. Flush with plain water 10 min ____
2. Flush with plain water 10 min ____
3. Flush with plain water 10 min ____
4. Flush with plain water 10 min ____
5. Flush with plain water 10 min ____

Add 4.5 gallons 50/50 mix coolant for the final 2 flushes.

1. Flush with 50/50 mix 10 min ____
2. Flush with 50/50 mix 10 min ____

HEATER CORE FLUSH

Attach flush hoses to heater core. Fill supply bucket with 4.5 gallons of plain water flush 4 times.

1. Flush with plain water ____
2. Flush with plain water ____
3. Flush with plain water ____
4. Flush with plain water ____
5. Disconnect flush hoses ____
6. Remove thermostat ____ plug ____

END ATTACHING PHOTOS TO A CLAIM

Go to the **Photo Attachments** area of the claim form to upload images as shown below.

1. To attach photos to the claim, click on **Upload Images**.

Sublet Information				
Sublet Code	Invoice No.	Work Description	Sublet Amount	Rental Days
PH	1234567899	ENGINE BLOCK	500.00	
<< SELECT >>				
Upload Images		Photo Attachments	View Images	

The **Claim Photo Attachment** screen appears.

• = Required

Claim Photo Attachment

[Close](#)

Uploaded Images 0 (Maximum 5) Fit To Window Full Size

Browse... [Preview](#) [Upload](#)

2. Click on **Browse**. The **Choose File to Upload** window appears.

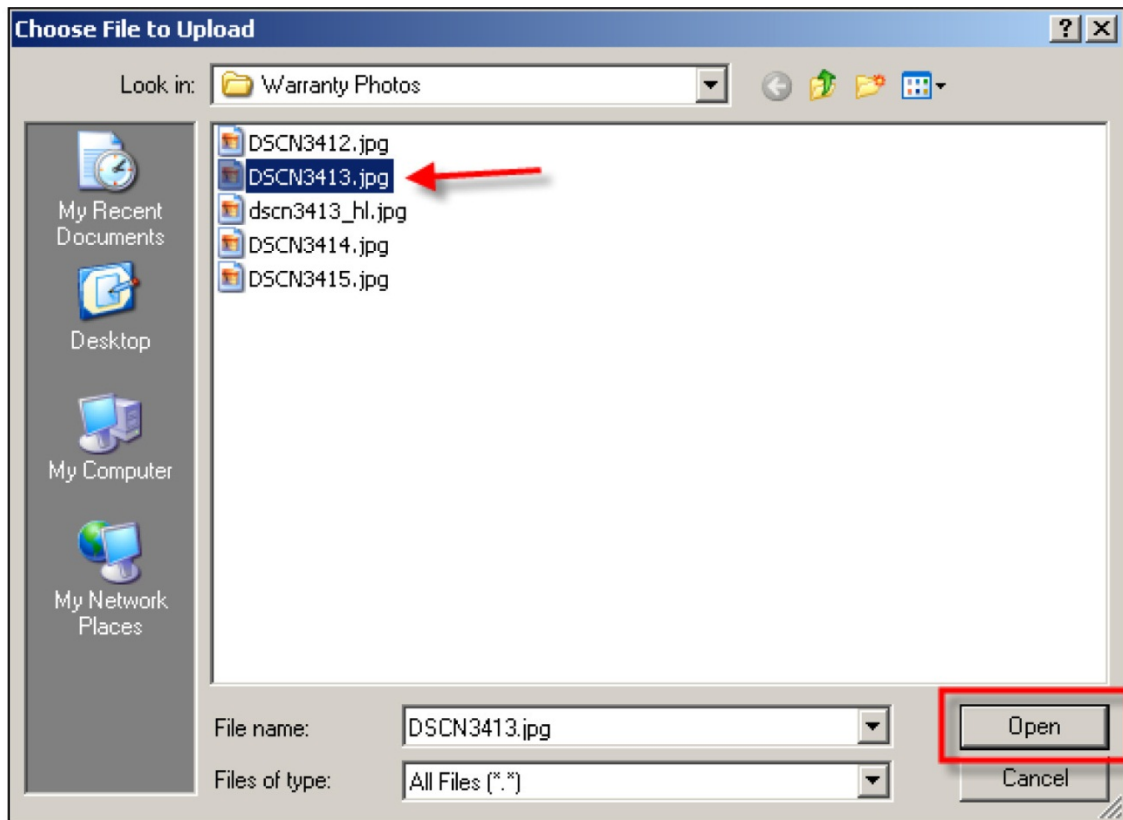

3. Click on an image file to be uploaded.
4. Click on **Open** to select the file.

5. Click on **Preview** if you would like to view the image before uploading. The preview image appears. **Fit To Window** is selected by default as the size at which the preview image is displayed. Click on **Full Size** if you want to enlarge the image, and use the scrollbars to view different areas of the enlarged image.



6. Click on **Upload** to attach the image to the warranty claim. The **Uploaded Images** count increases each time you upload a photo.

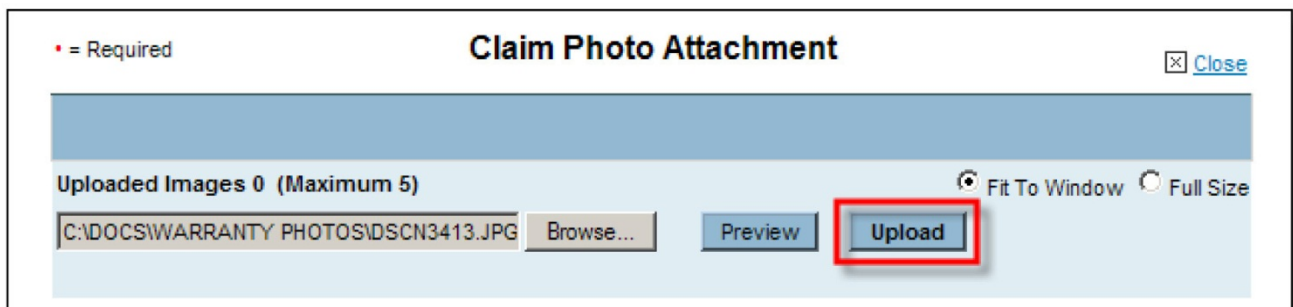

7. Click on **Browse** again and follow the same steps to continue attaching images to the claim. To properly document each warranty repair claim, at least 3 photos must be attached.

8. When finished attaching photos, click on **Close**.

The file names of your attached photos now appear in the **Photo Attachments** area of the claim form as shown below.

Sublet Information				
Sublet Code	Invoice No.	Work Description	Sublet Amount	Rental Days
PH	1234567899	ENGINE BLOCK	500.00	
<< SELECT >>				
Upload Images		Photo Attachments		View Images
dscn3413_hl.jpg	DSCN3412.jpg	DSCN3414.jpg	DSCN3415.jpg	





VIEWING AND DELETING PHOTO ATTACHMENTS

After uploading photo attachments, you can view the photos by clicking on **View Images** in the **Photo Attachments** area. The **Claim Photo Attachment** screen displays thumbnails of all photos attached to the claim.

Sublet Information				
Sublet Code	Invoice No.	Work Description	Sublet Amount	Rental Days
PH	1234567899	ENGINE BLOCK	500.00	
<< SELECT >>				
Upload Images		Photo Attachments		View Images
dscn3413_hl.jpg	DSCN3412.jpg	DSCN3414.jpg	DSCN3415.jpg	

Claim Photo Attachment Close

Images Uploaded: 4 Fit To Window Full Size

- [Delete](#)  dscn3413_hl.jpg
- [Delete](#)  DSCN3412.jpg
- [Delete](#)  DSCN3414.jpg
- [Delete](#)  DSCN3415.jpg



Made in Canada Fabrique en Canada

Click on a thumbnail to view the photo attachment as shown above. To delete a photo attachment, simply click on **Delete** to the left of its thumbnail.



When your claim and photos are completely ready, click on **Submit** to send the claim to the American Honda Warranty department.

WARRANTY CLAIM PHOTO ATTACHMENT INQUIRY

After submitting a warranty claim, you can view its photo attachments at any time as follows:

1. Click on **Service > Warranty > Warranty Claim Photo Attachment Inquiry**.
2. Enter any of the following: **Claim Number**, **VIN**, **Repair Order Number**, or **Repair Order Date**.
3. Click on **submit**. Thumbnails of all photos attached to the claim appear as shown below.
4. Click on any thumbnail to view the photo attachment.

NOTE:

- Photo attachments are archived on the iN for 2 years.
- Whenever you open a saved warranty claim and attach or delete photos, you must either **save** or **submit** the claim to retain your photo attachment changes.

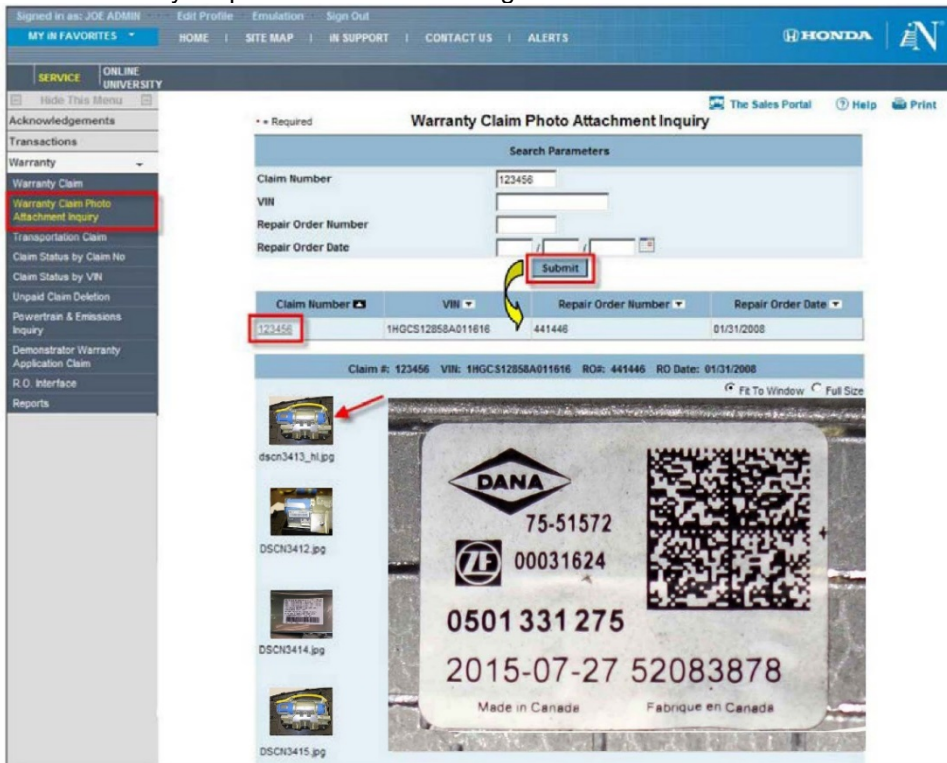

CORRECTING PHOTO PROBLEMS USING PICTURE MANAGER

Microsoft Office Picture Manager is a very useful tool to help improve the quality of photos submitted for warranty consideration.

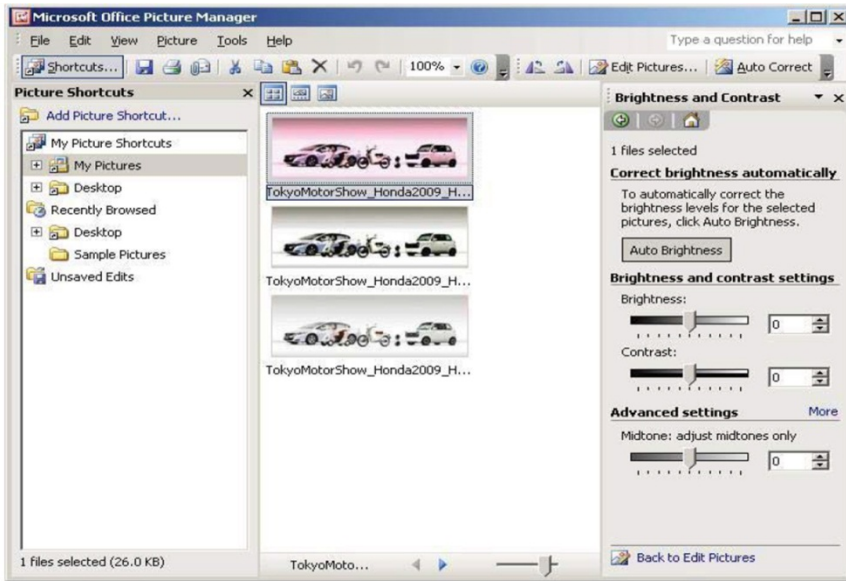

While the Picture Manager program cannot correct blurry, out-of-focus pictures, it can adjust pictures for brightness, contrast, and color, helping to reveal details. It can also crop or resize digital photo files so that they can be submitted for warranty claim consideration.

- To use this program on your PC, click on **Start > Programs > Microsoft Office > Microsoft Office Tools > Microsoft Office Picture Manager**.
- If the above instruction does not lead you to the Picture Manager program, click on **Start > Search**. Under **Search for Folders or Files**, enter **Picture Manager** in the Search window, then click on **Search Now**.
- To create a shortcut to open Microsoft Picture Manager from your desktop, go to **Start > Programs > Microsoft Office > Microsoft Office Tools > Microsoft Picture Manager >**, then right-click and choose **Create Shortcut**. The shortcut icon and title will appear below the original Microsoft Picture Manager icon and title. Left-click and hold on the shortcut icon, and drag it to the desktop. Once there, if you wish to change its name, right-click on the icon and select **Rename**.
- To open and edit photos directly from Microsoft Picture Manager, right-click on any JPEG picture file, then move your cursor to **Open with**.

Another window will open listing Microsoft Office Picture Manager and other programs. **Do not** click on **Picture Manager**, but instead scroll down the list, then click on **Choose Program**.

Another window will open, with Picture Manager already selected. Check the open box next to **Always use the selected program to open this kind of file**; this will make Picture Manager your default picture management program.

NOTE: The next time you click on a JPEG photo, it will automatically open in the Picture Manager program.

Correction Example #1: Photo Is Too Dark

In Picture Manager, select **Edit/Edit Pictures > Edit Using These Tools/Brightness and Contrast**. Use the sliding scales to adjust the photo to the brightness and contrast that best reveal the fault.

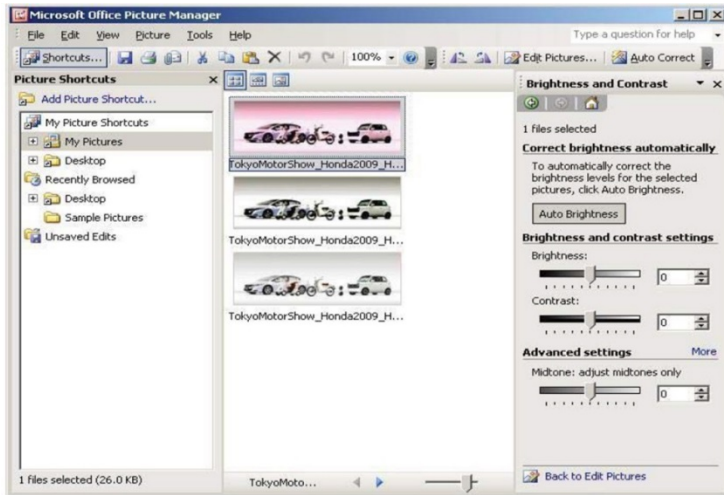

Before Picture Manager Correction

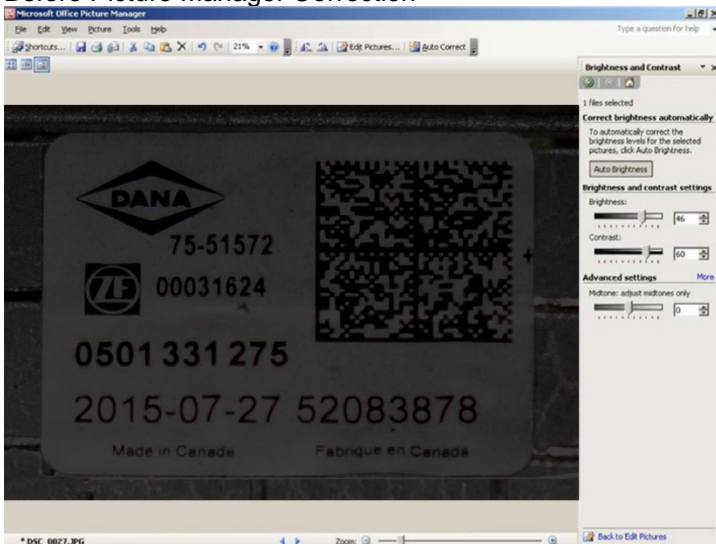

After Picture Manager Correction

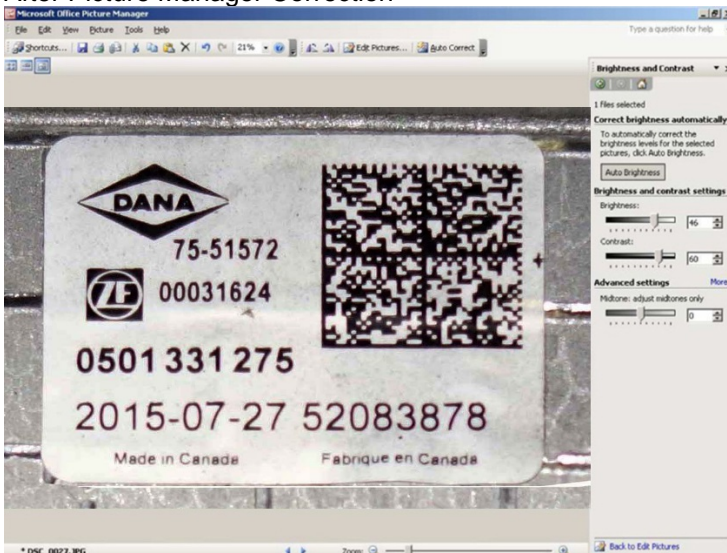

Correction Example #2: Photo Size Is Too Large

For maximum clarity, **the file size for each photo must be between 500 kB and 10,000 kB (10 mB)**. ZIP-compressed files are not acceptable. Photo file sizes over 10,000 kB (10 mB) cannot be accepted by the American Honda Warranty department.

To reduce a picture's file size, open Picture Manager. Click on the photo to be reduced, click on **Edit Pictures > Resize > Percentage of original width x height**, then click on the down arrow to reduce its percentage (%) size.

View the pixel count change in **Size Setting Summary**, which displays the photo's **Original size** and its **New size**.

NOTE: The % function changes the pixels per inch, so a photo's size should be reduced only enough to meet the maximum file size requirement. For example, a 10% reduction in pixels per inch will reduce a photo's size and its resolution by almost 50%.

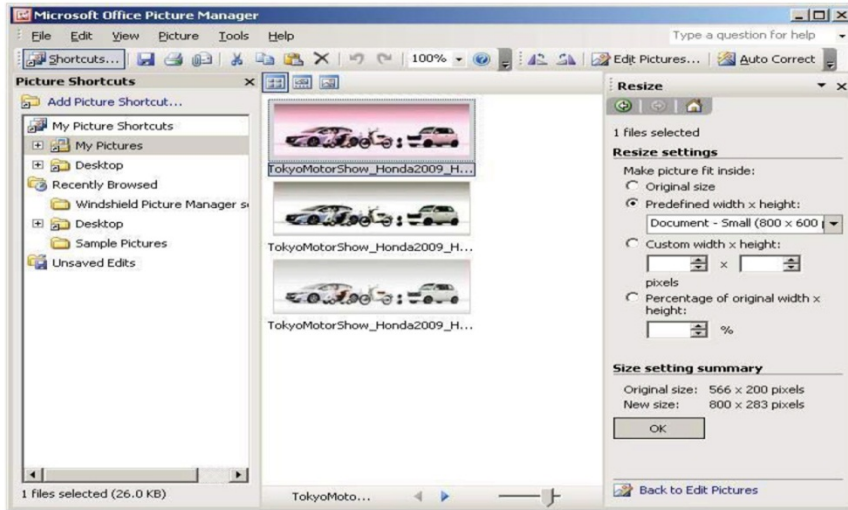

END