

**Classification:**

HA16-006b

**Reference:**

ITB16-037b

**Date:**

November 22, 2016

## 2014-2016 Q50; AIR MIX DOOR MOTOR LH SERVICE INFORMATION

**This bulletin has been amended throughout. Discard all previous versions of this bulletin.**

**APPLIED VEHICLES:** 2014-2016 Q50 and Q50 Hybrid (V37)

### SERVICE INFORMATION

When replacing the Air Mix Door Motor LH in an **APPLIED VEHICLE** for any reason, the instrument panel and/or heater case does not need to be removed as part of the procedure. **Do not** remove either the instrument panel or the heater case from the vehicle for this procedure.

When replacing the Air Mix Door Motor LH in an **APPLIED VEHICLE** for any reason, use the **SERVICE PROCEDURE** in this bulletin.

When this repair is performed under warranty, use the **CLAIMS INFORMATION** in this bulletin.

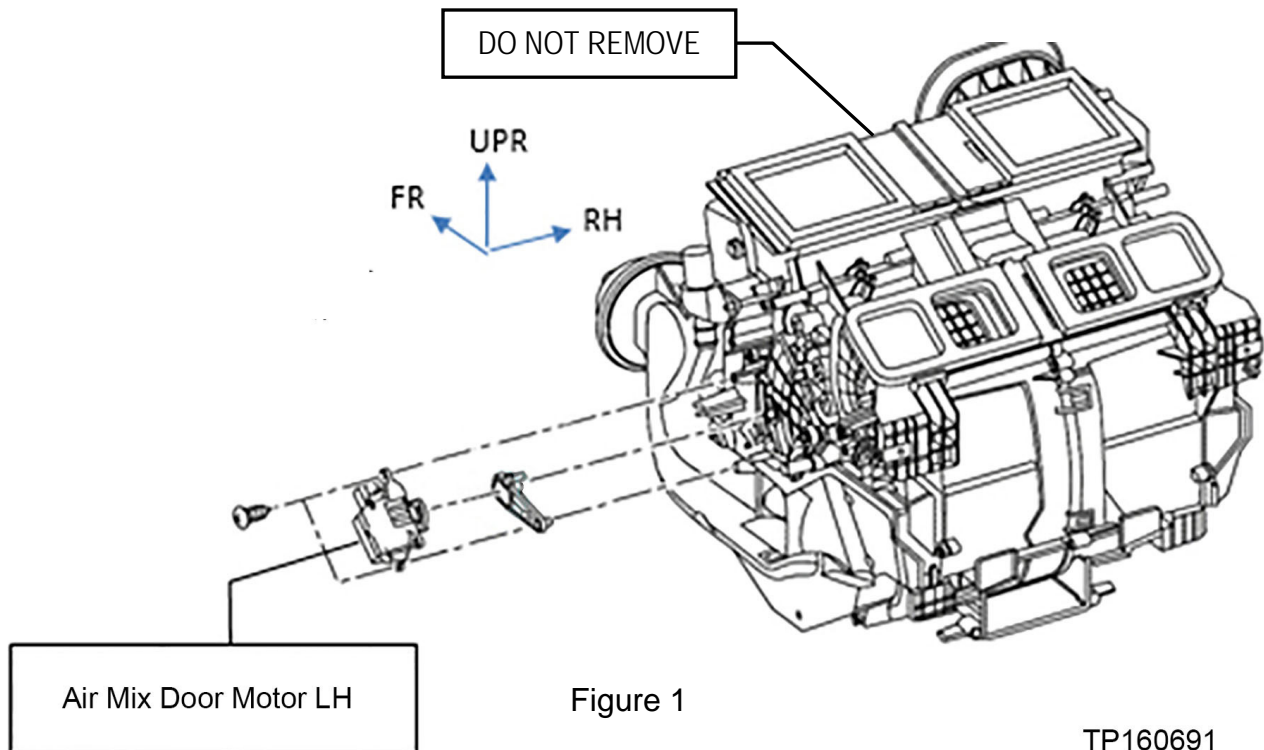

Infiniti Bulletins are intended for use by qualified technicians, not 'do-it-yourselfers'. Qualified technicians are properly trained individuals who have the equipment, tools, safety instruction, and know-how to do a job properly and safely. **NOTE:** If you believe that a described condition may apply to a particular vehicle, DO NOT assume that it does. See your Infiniti retailer to determine if this applies to your vehicle.

## SERVICE PROCEDURE

### Air Mix Door Motor LH Removal

1. Remove the instrument panel side finisher LH with a suitable finesse tool (see Figure 2).
2. Remove the instrument lower panel LH (see Figure 3).
  - a. Disconnect the aspirator duct.
  - b. Disconnect all electrical connections, and then disconnect all harness clips.
  - c. Disconnect the hood release handle and cable.



Figure 2

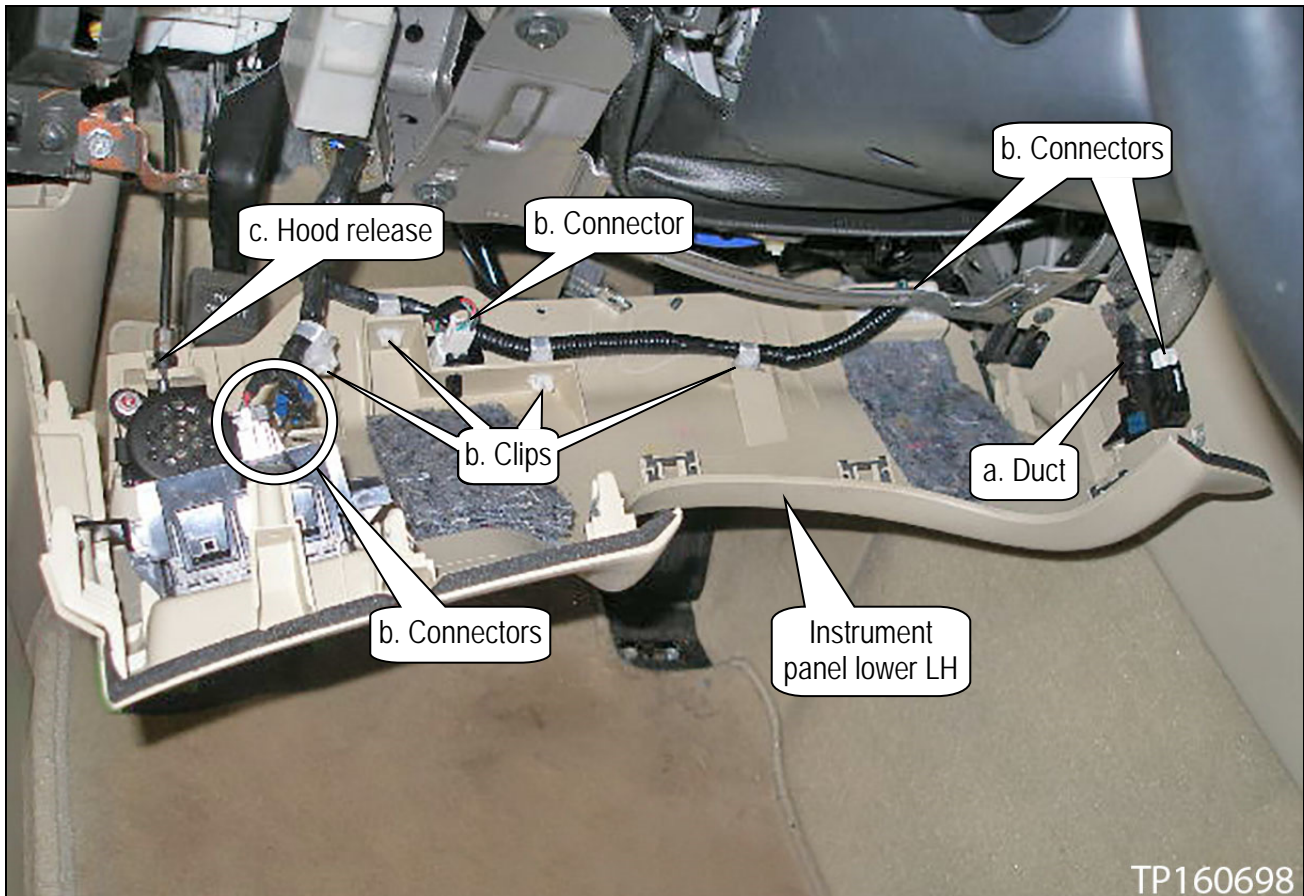

Figure 3

3. Remove the four (4) bolts, and then remove bracket 1 (see Figure 4).

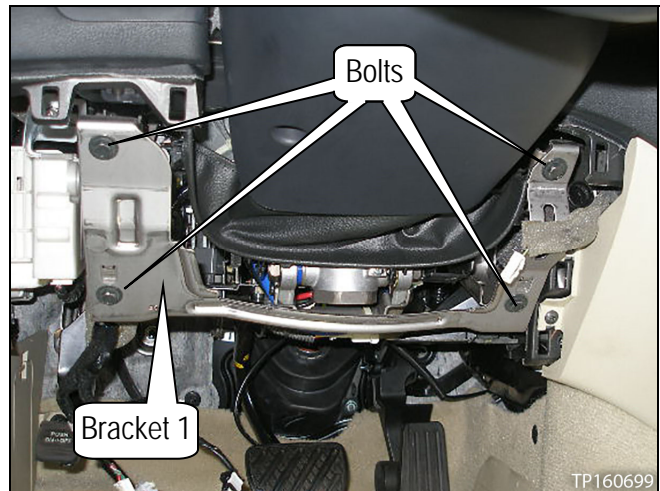

Figure 4

4. Remove the heater duct.
  - a. Unfasten the heater duct by inserting a flat blade screwdriver and GENTLY twisting it to release the duct from the clip (see Figure 5).
  - b. After unfastening at the top, the heater duct will lift off a pin at the duct bottom.

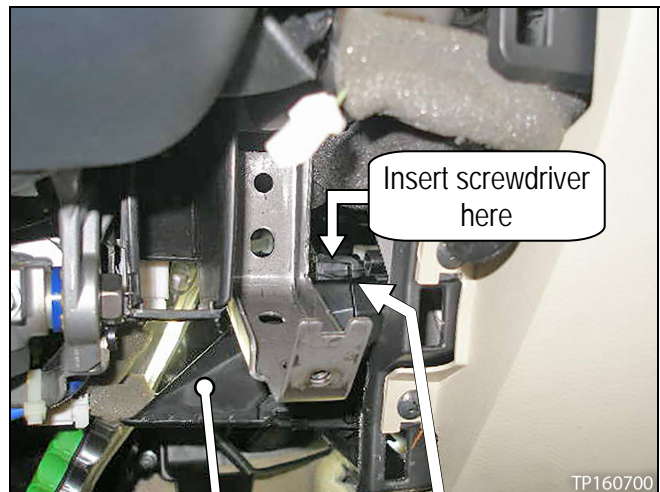

Figure 5

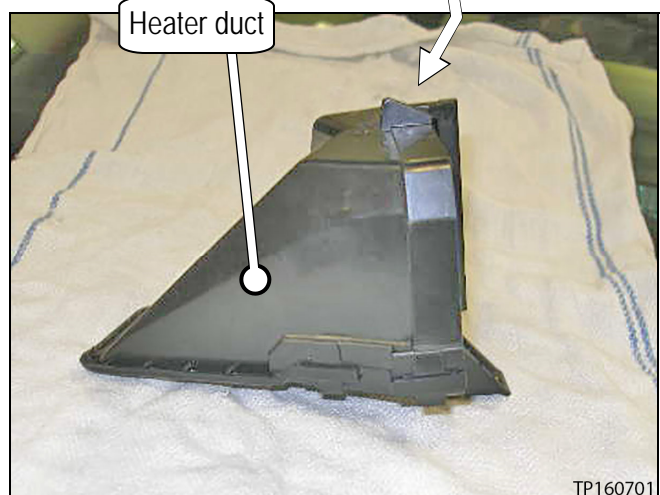

Figure 6



5. Remove bracket 2 (see Figure 7).
  - a. Remove the screw.
  - b. Turn the bracket to get to the backside of the harness clip, and then pinch with a suitable tool to unfasten it.

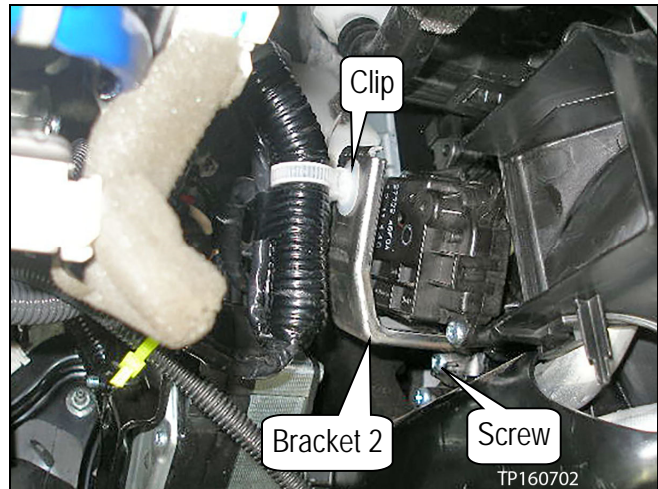

Figure 7

6. Remove the air mix door motor LH (see Figure 8).
  - a. Remove the two (2) screws.
  - b. Pull off the air mix door motor LH, and then disconnect its electrical connector.

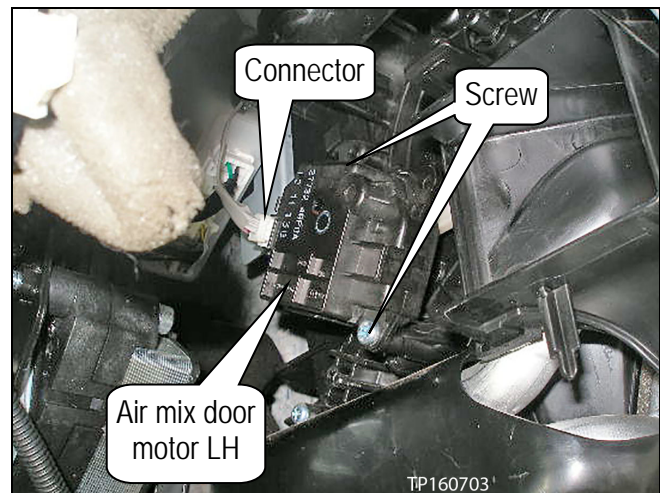

Figure 8

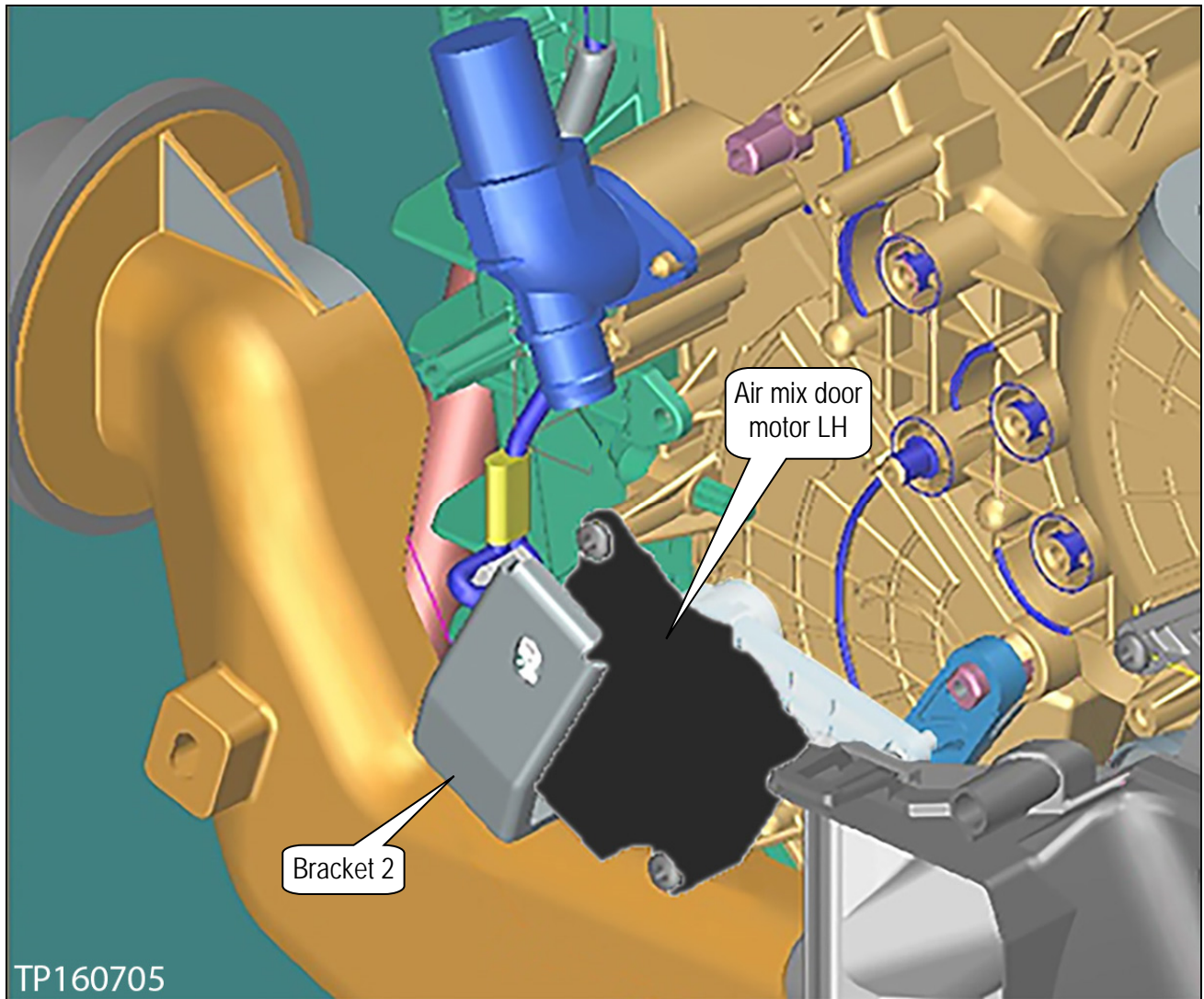

Figure 9

### Air Mix Door Motor LH Installation

1. Install the new air mix door motor LH in reverse order of removal.

### CLAIMS INFORMATION

Submit a Primary Part (PP) type line claim using the following claims coding:

DESCRIPTION	PFP	OP CODE	SYM	DIA	FRT
Replace Air Mix Door Motor	27742-4GF0A	TX46AA	ZE	32	0.5