

Technical Service Bulletin



69 Airbag lamp on; upper limit of side airbag exceeded

69 13 27 2010144/4 December 10, 2013. Supersedes Technical Service Bulletin Group 69 number 08-11 dated December 10, 2008 for reasons listed below.

Model(s)	Year	VIN Range	Vehicle-Specific Equipment
A3	2006	000001 - 166831	Not Applicable
A4	2002 - 2005	000001 - 999999	
A4	2006	000001 - 227246	
A4 Cabriolet	2003 - 2005	000001 - 999999	
A4 Cabriolet	2006	000001 - 011350	

Condition

REVISION HISTORY		
Revision	Date	Purpose
2	-	Revised header data (Added DTCs; updated customer codes) Revised <i>Required Parts and Tools</i> (Updated part numbers)
1	11/17/2008	Initial publication

- The airbag warning lamp is illuminated in the instrument cluster.
- The following sporadic DTCs are stored in the airbag control module, J234 (address word 15):
 - **DTC 01217:** Igniter for side airbag driver's side -N199- upper limit exceeded
 - **DTC 01218:** Igniter for side airbag passenger side -N200- upper limit exceed

Technical Background

This condition may be caused by sporadic high resistance in the connector between the airbag and seat harness, even though the side airbag system is functioning normally.

Production Solution

The connector under the seat bottom has been eliminated in production. The connector for the side airbag has been optimized for additional clearance.

Service

Warning:

Always read and follow Repair Manual warnings, precautions, notes, and tips when working on any airbag system.



Tip: Note, and if necessary, determine the radio code for vehicles equipped with coded anti-theft radio.

1. Disconnect battery ground (GND) strap.
2. Remove seat. See *Repair Manual >> Body >> Body Interior >> 72 Seat Frames >> Removal and Installation*.
3. Attach airbag adapter VAS 6036 (Figure 1) to seat harness. See "Airbag Adapter VAS 6036, Connecting" for the appropriate seat type in *Repair Manual >> Body >> Body Interior >> 72 Seat Frames >> Description and Operation*.



Tip: The adapter must remain connected as long as the seat is removed from the vehicle.



Tip: The seat must be mounted on the seat mounting rack VAS 6095.

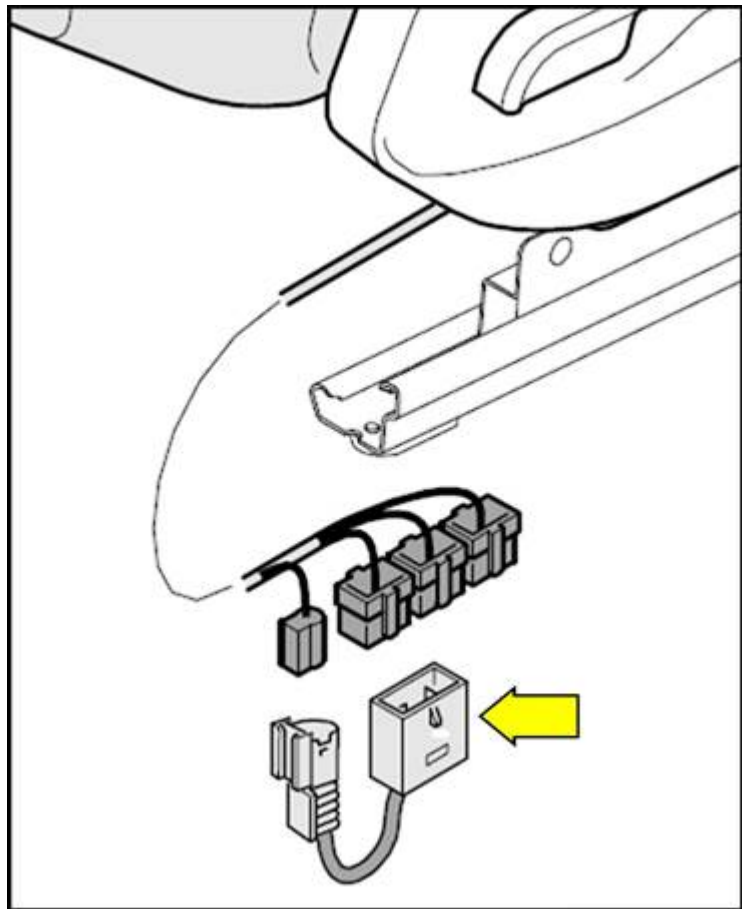

Figure 1. Airbag adapter indicated by yellow arrow.

Warning:

Before repairing the seat harness, technicians must ground themselves and the tools to be used by touching the mounting rack. If the repair is interrupted, technicians must ground themselves again before returning to the repair.

 **Warning:**

The airbag unit must not be left unattended.

4. Cut igniter wire 1 (on airbag side) next to airbag connector (Figure 2).

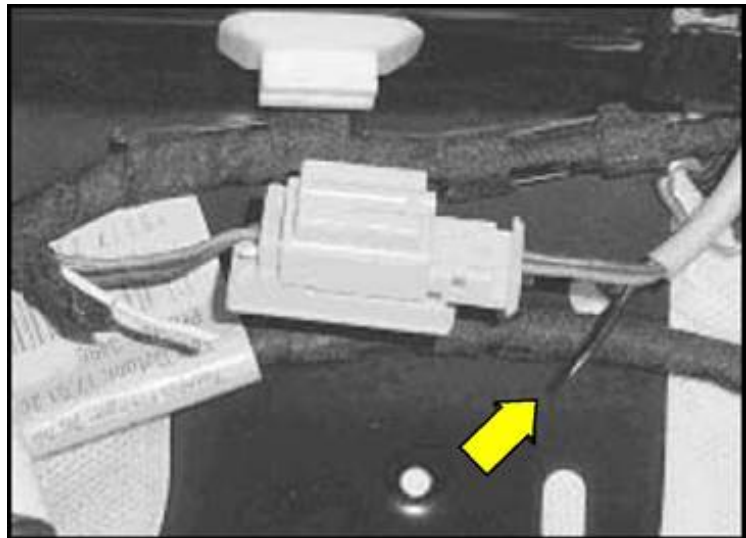

Figure 2. Igniter wire 1 on airbag side.

5. Cut igniter wire 1 (on seat harness side) next to airbag connector (Figure 3).

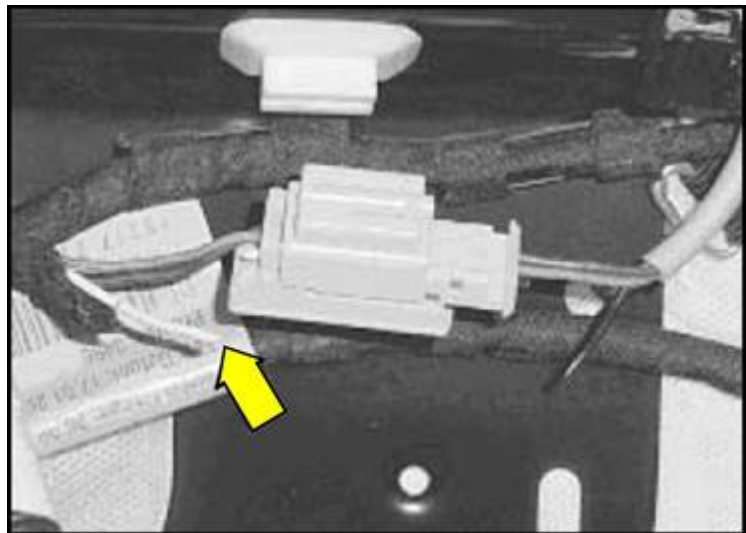

Figure 3. Igniter wire 1 on seat harness side.

6. Using VAS 1978A wiring repair kit (including crimping tool VAS 1978/1 with VAS 1978/24 insert): Strip wires and splice using a 4-inch section of repair wire (000979010) and 2 butt connectors (111971941A). This allows the harness additional slack.

- Repeat steps 4, 5, and 6 for igniter wire 2 (Figure 4).

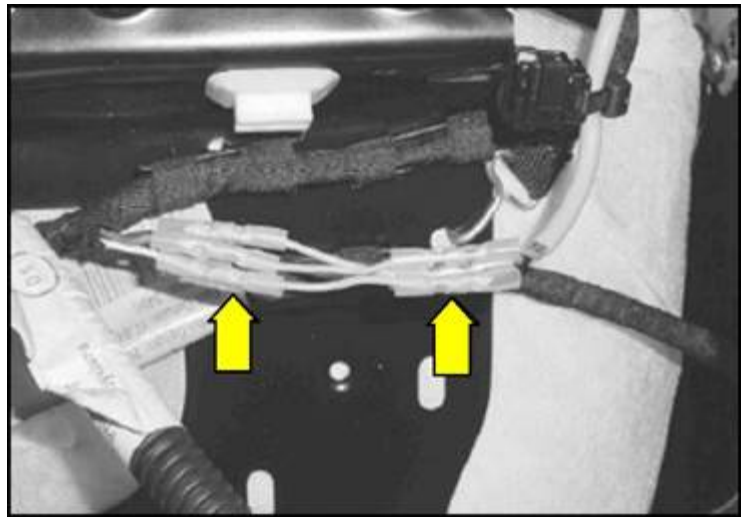



Figure 4. Igniter wire 2.

- Repeat steps 4, 5, and 6, for ground wire 3, crimping one pair of wires at a time until the connector is removed.

 **Note:** On some vehicles, the ground wire for the airbag is run outside and along the connector. If this is the case, *do not* cut the ground wire.

- Discard connector.
- Twist repaired wires (Figure 5).

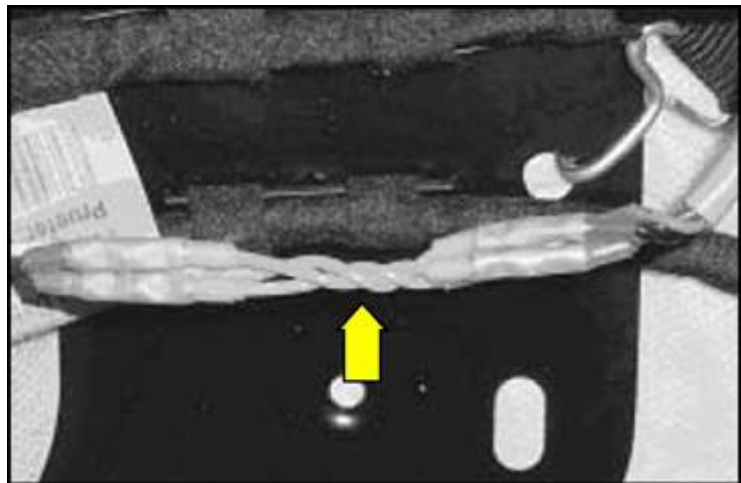

Figure 5. Repaired wires that have been twisted.

11. Wrap the repair using yellow electrical tape to indicate that the wiring harness has been modified (Figure 6).

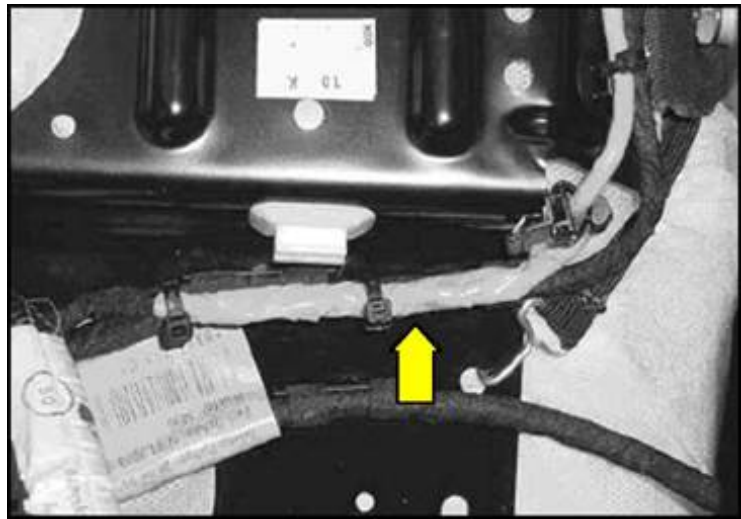

Figure 6. Repaired wires wrapped in electrical tape.

12. Secure the repaired harness with tie wraps.
13. Install seat. See *Repair Manual >> Body >> Body Interior >> 72 Seat Frames >> Removal and Installation.*
14. Switch ignition on.
15. Reconnect battery ground strap (GND).

Warning:

Ensure that there are no people inside of the vehicle when reconnecting the battery ground strap.

16. Connect the diagnostic tester. Clear any stored DTCs and verify the repair.
17. Program radio presets if necessary.
18. Check vehicle equipment (radio code, clock, electrical windows) per *Repair Manual* and/or *Owner's Manual*.

Technical Service Bulletin



Warranty

Claim Type:	Use applicable claim type. If vehicle is outside any warranty, this Technical Service Bulletin is informational only.		
Service Number:	9766		
Damage Code:	0023		
Labor Operations:	Central wiring harness repair	9709 4165	130 TU
Diagnostic Time:	GFF	0150 0000	Time stated on diagnostic protocol (Max 30 TU)
	Road test prior to service procedure	No allowance	0 TU
	Road test after service procedure	No allowance	0 TU
	Technical diagnosis at dealer's discretion (Refer to Section 2.2.1.2 and Audi Warranty Online for DADP allowance details)		
Claim Comment:	As per TSB #2010144/4		

Required Parts and Tools

Part Number	Part Description	Quantity
000979940	Butt connector	6
000979010E	0.5 mm wire	1

Additional Information

All parts and service references provided in this TSB (2010144) are subject to change and/or removal. Always check with your Parts Department and service manuals for the latest information.