

JTB00566NAS3

TECHNICAL BULLETIN

28 NOV 2017



© Jaguar Land Rover North America, LLC

NOTE: The information in Technical Bulletins is intended for use by trained, professional Technicians with the knowledge, tools, and equipment required to do the job properly and safely. It informs these Technicians of conditions that may occur on some vehicles, or provides information that could assist in proper vehicle service. The procedures should not be performed by 'do-it-yourselfers'. If you are not a Retailer, do not assume that a condition described affects your vehicle. Contact an authorized Jaguar service facility to determine whether this bulletin applies to a specific vehicle.

INFORMATION

This reissue replaces all previous versions. Please destroy all previous versions.

Changes are highlighted in blue

SECTION:

303-03: Engine Cooling

SUBJECT/CONCERN:

Coolant Leak From The Engine Compartment

AFFECTED VEHICLE RANGE:

MODEL:	MODEL YEAR:	VIN:	ASSEMBLY PLANT:	APPLICABILITY:
F-TYPE (X152)	2014 Onwards	K00001 Onwards	Castle Bromwich	V6 S/C 3.0L Petrol /V8 S/C 5.0L Petrol
XF (X250)	2012-2015	S52534- U88785	Castle Bromwich	V6 S/C 3.0L Petrol /V8 S/C 5.0L Petrol
XJ Range (X351)	2012 Onwards	V39060 Onwards	Castle Bromwich	V6 S/C 3.0L Petrol /V8 S/C 5.0L Petrol

MARKETS:

NORTH AMERICA

CONDITION SUMMARY:**SITUATION:**

An 'engine overheat' message may be displayed on the Instrument Cluster and that coolant may be leaking from engine compartment area.

CAUSE:

This may be caused by weakness in the plastic weld process of the coolant pipes.

ACTION:

Should a Customer express this concern, follow the Workshop Procedure below.

PARTS:

PART NUMBER	DESCRIPTION	QUANTITY
AJ813917	Coolant outlet pipe - Upper	1

PART NUMBER	DESCRIPTION	QUANTITY
AJ813865	Coolant outlet pipe - Lower	1
C2Z17249	Gasket - Supercharger-to-cylinder head - V6 3.0L S/C Petrol	2
C2Z17248	Gasket - Intake manifold - V6 3.0L S/C Petrol	1
C2Z28265	Throttle body gasket	1
AJ811576	Gasket - Right bank - Supercharger-to-cylinder head - V8 5.0L S/C Petrol	1
AJ811590	Gasket - Left bank - Supercharger-to-cylinder head - V8 5.0L S/C Petrol	1
AJ811948	Gasket - Intake manifold - V8 5.0L S/C Petrol	1
JLM209722	Engine coolant	1

TOOLS:

303-1449-01

Supercharger
Installation
Guide Pins -
Threaded

WARRANTY:
NOTES:

- Repair procedures are under constant review, and therefore times are subject to change; those quoted here must be taken as guidance only. Always refer to JLR claims submission system to obtain the latest repair time.
- The JLR Claims Submission System requires the use of causal part numbers. Labor only claims must show the causal part number with a quantity of zero.

DESCRIPTION	SRO	TIME (HOURS)	CONDITION CODE	CAUSAL PART
Coolant outlet pipe - Upper & lower - Renew - F-TYPE (X152; V6 3.0L S/C Petrol)	26.31.97	3.5	D4	C2Z28536
Coolant outlet pipe - Upper & lower - Renew - F-TYPE (X152; V8 5.0L S/C Petrol)	26.31.97	3.6	D4	C2Z28536
Coolant outlet pipe - Upper & lower - Renew - XF (X250; V6 3.0L S/C Petrol)	26.31.97	4.2	D4	C2Z28536
Coolant outlet pipe - Upper & lower - Renew - XF (X250; V8 5.0L S/C Petrol)	26.31.97	4.3	D4	C2Z28536
Coolant outlet pipe - Upper & lower - Renew - XJ (X351; V6 3.0L S/C Petrol / V8 5.0L S/C Petrol)	26.31.97	4.2	D4	C2Z28536

NOTE:

Normal Warranty procedures apply.

WORKSHOP PROCEDURE:

CAUTIONS:

- When refilling the cooling system, make sure to use the Jaguar Land Rover approved specification of engine coolant at a 50% mix ratio with water and check the specific gravity of the engine coolant (see TOPIx Workshop Manual section 303-03: Engine Cooling - Specification - V8 S/C 5.0L Petrol).

- Use only Jaguar Land Rover-approved engine coolant.

NOTE:

V8 5.0L S/C Petrol shown, V6 3.0L S/C Petrol similar.

- 1 Remove the charge air cooler (see TOPIx Workshop Manual section 303-12: Intake Air Distribution and Filtering - Charge Air Cooler).
- 2 Remove the air cleaner outlet pipe T-connector (see TOPIx Workshop Manual section 303-12: Intake Air Distribution and Filtering - Air Cleaner Outlet Pipe T-Connector).

3

CAUTION:

Be prepared to collect escaping engine coolant.

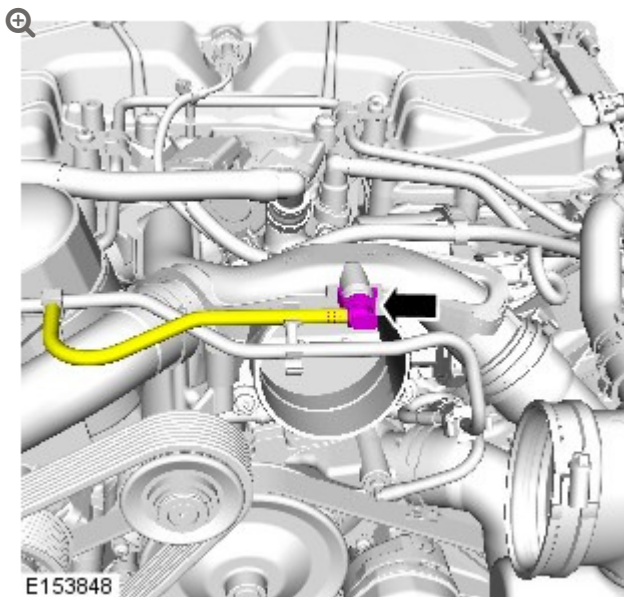

Disconnect and reposition the hose.

4

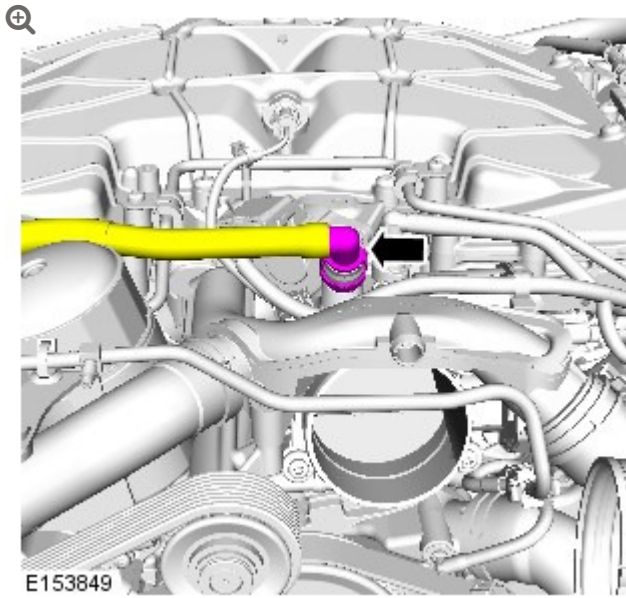

Disconnect and reposition the hose.

5

CAUTION:

Be prepared to collect escaping engine coolant.

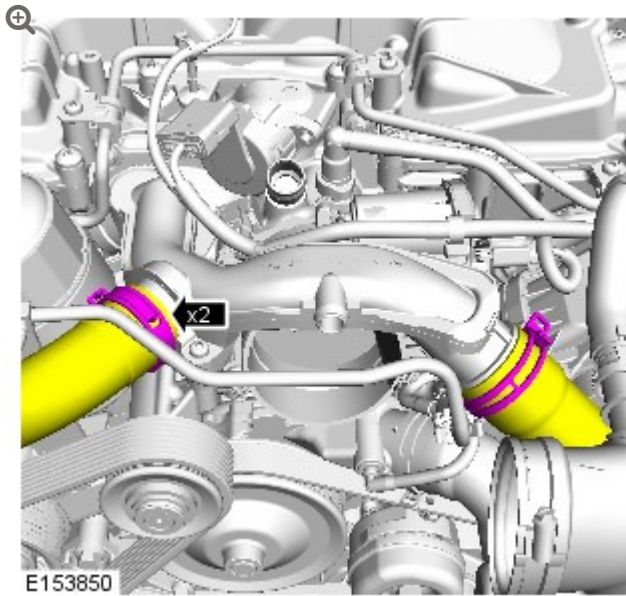

Disconnect and reposition the hoses.

6

CAUTION:

Be prepared to collect escaping engine coolant.

NOTE:

Make sure to retain the fasteners.

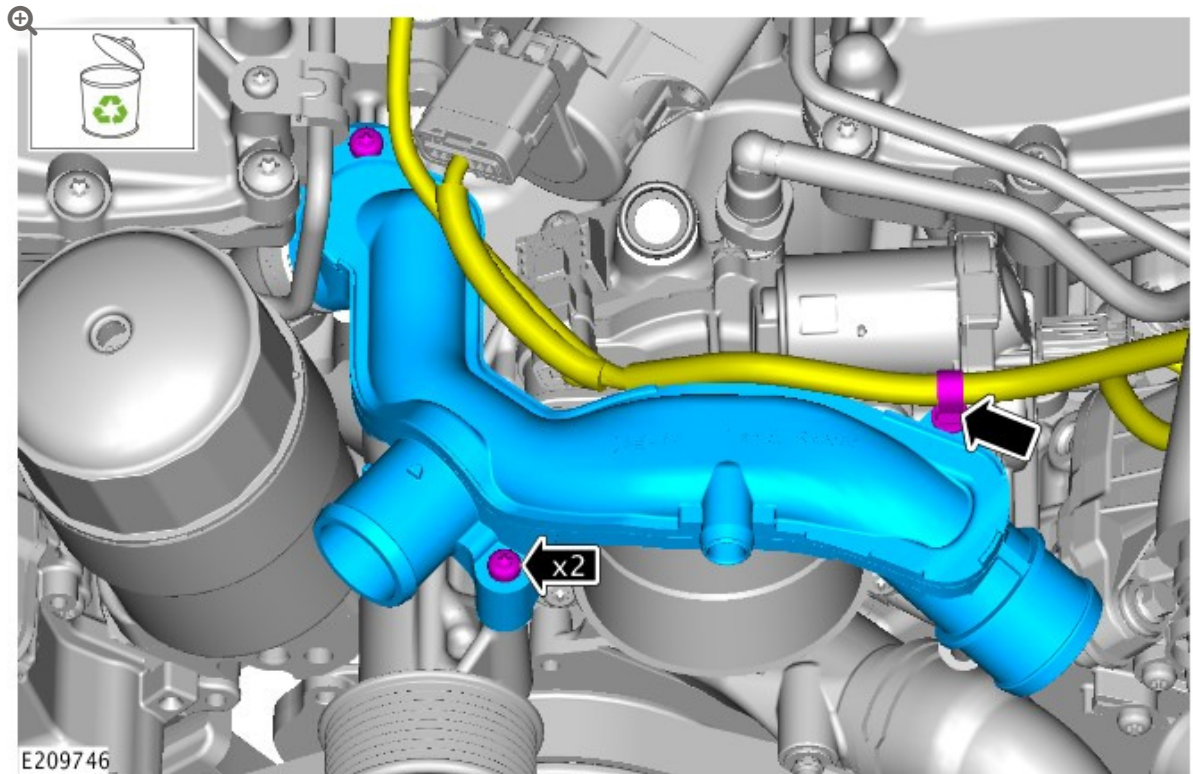

Remove and discard the upper coolant outlet pipe.

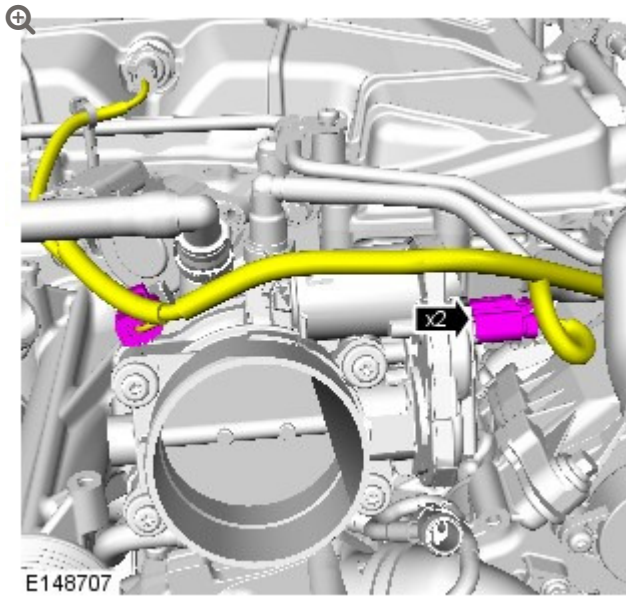

Disconnect the wiring harness from the throttle body.

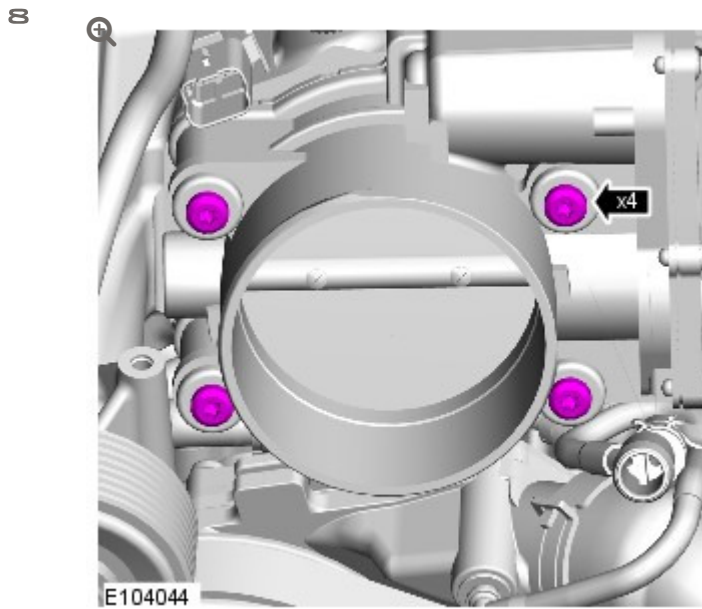

Remove the throttle body fasteners.

9

CAUTION:

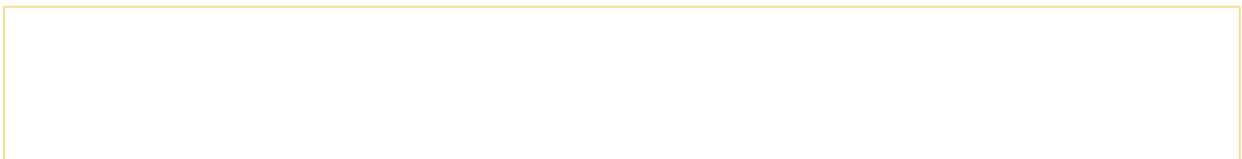

Take extra care when removing the throttle body. Failure to follow this instruction may result in damage to the Manifold Absolute Pressure and Temperature (MAPT) sensor.

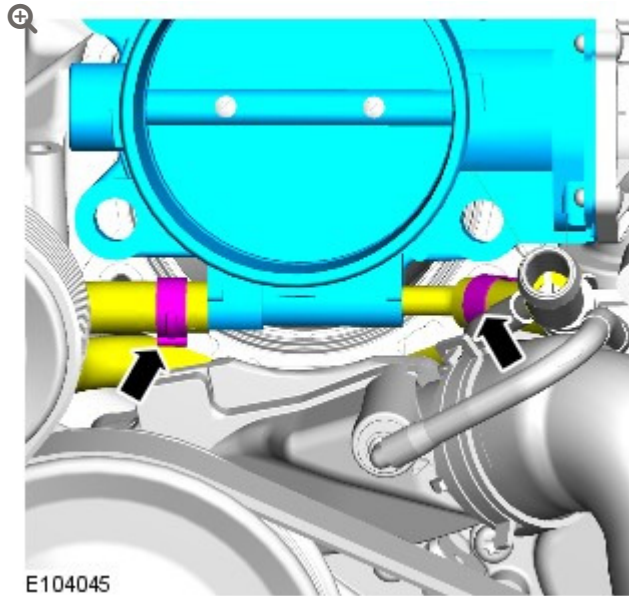

Disconnect the hoses and remove the throttle body.

-
- 10 Remove the supercharger belt (see TOPIx Workshop Manual section 303-05: Accessory Drive - Supercharger Belt).
-

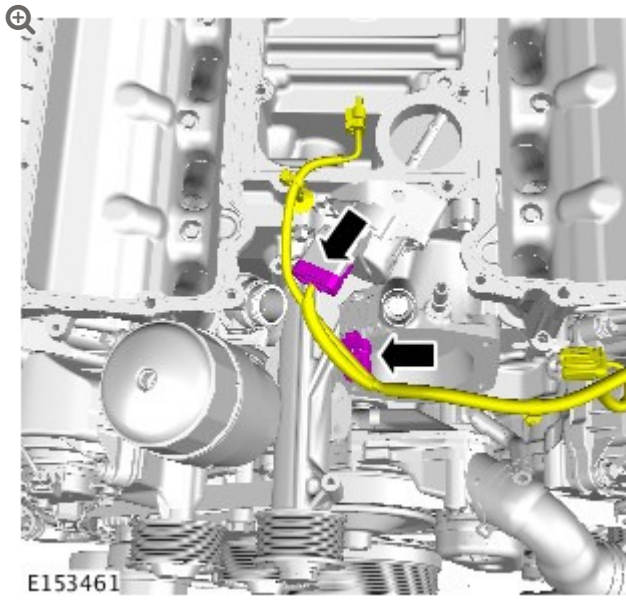

Disconnect and reposition the wiring harness.

12

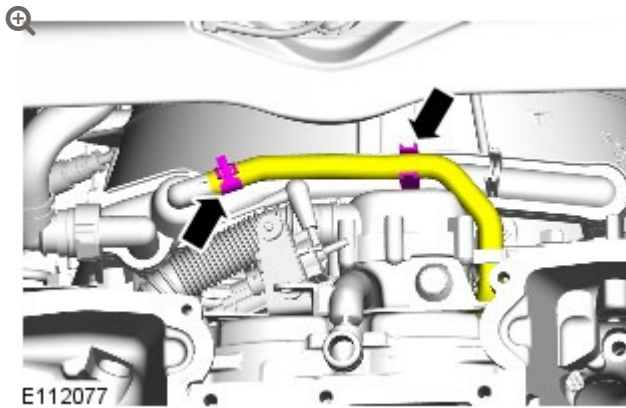

Disconnect and reposition the hose.

13

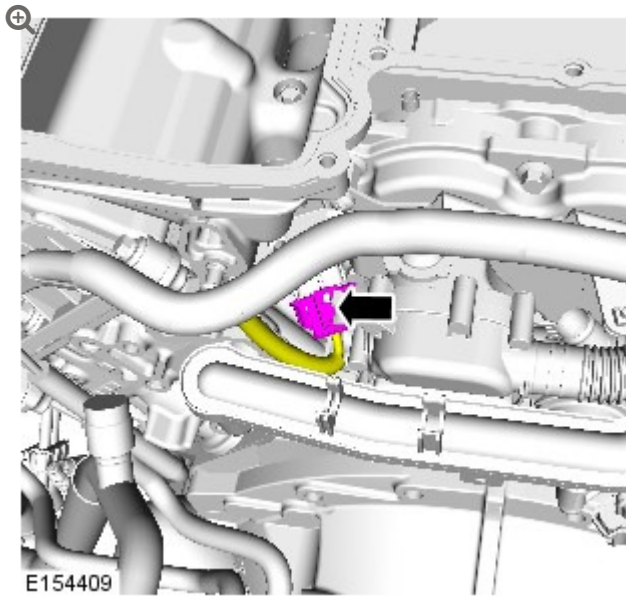

Disconnect and reposition the hose.

14

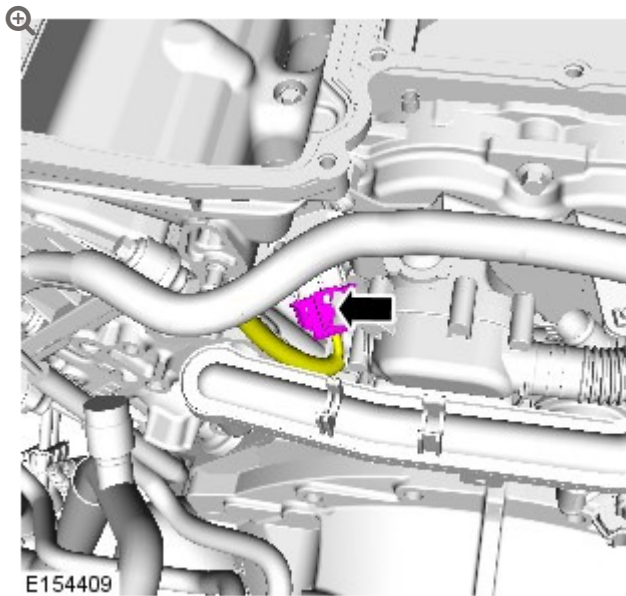

Disconnect and reposition the wiring harness.

15

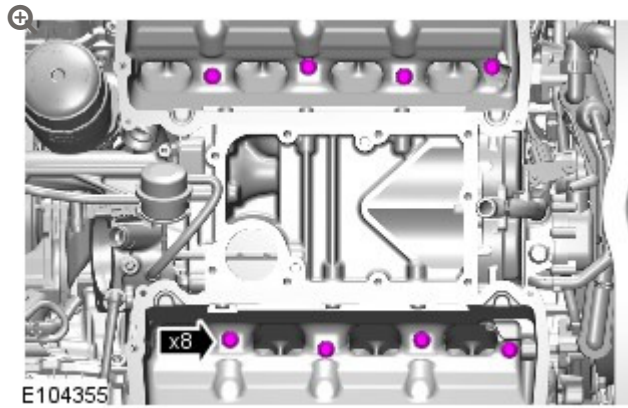

Remove the fasteners.

16

NOTE:

The shape of the gasket may differ from the one shown in the illustration.

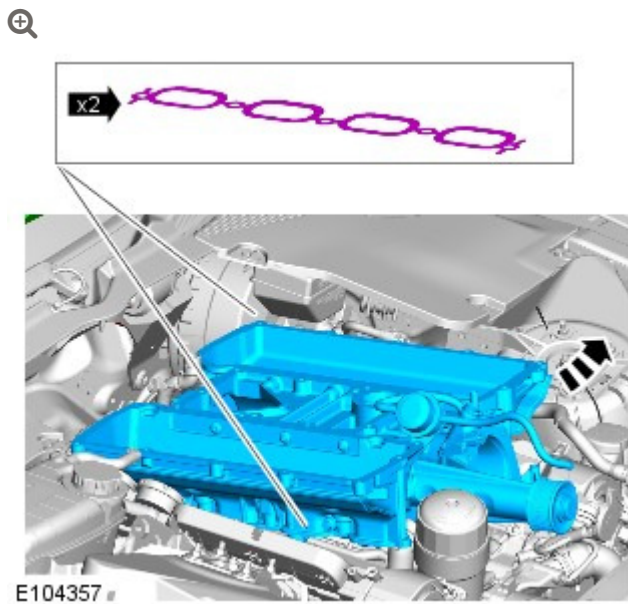

Remove the supercharger assembly.

- Discard the gaskets.

17

CAUTIONS:

- Be prepared to collect escaping engine coolant.
- Make sure no part of the lower coolant return pipe remains in both cylinder block recesses as these plastic pipes can sometimes break up on removal.

NOTE:

Make sure to retain the fasteners.

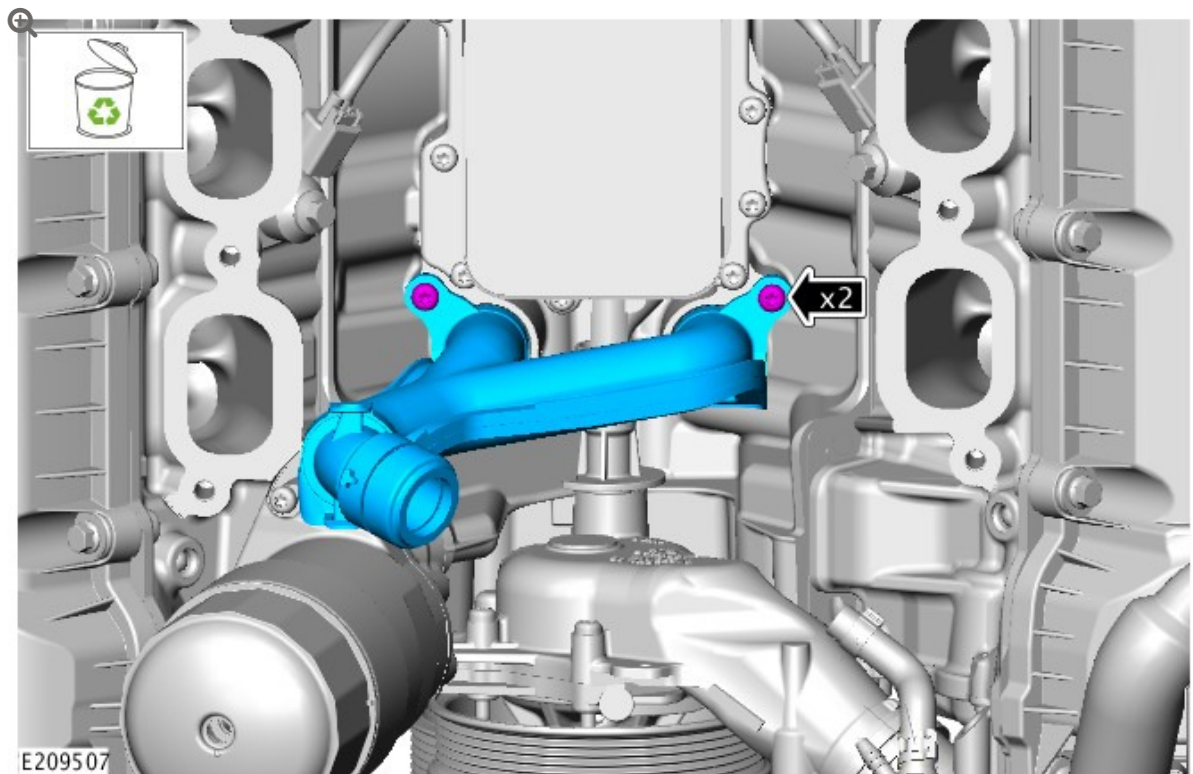

Remove and discard the lower coolant outlet pipe.

18

CAUTION:

When installing the new coolant pipe into the cylinder block, make sure the O-rings are correctly installed.

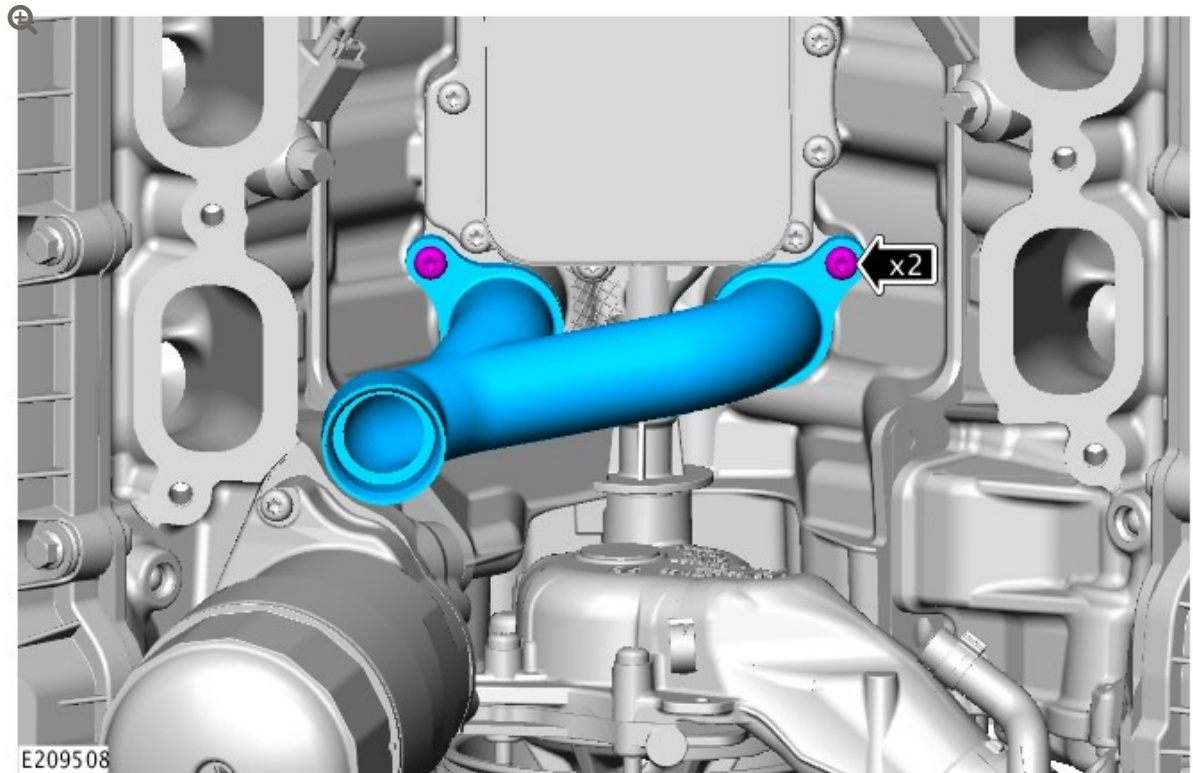

Install the replacement lower coolant outlet pipe.

- Torque: **12 Nm**.

19



Install the guide pins to aid installation of the supercharger.

20

CAUTION:

Make sure that the mating faces are clean and free of foreign material.

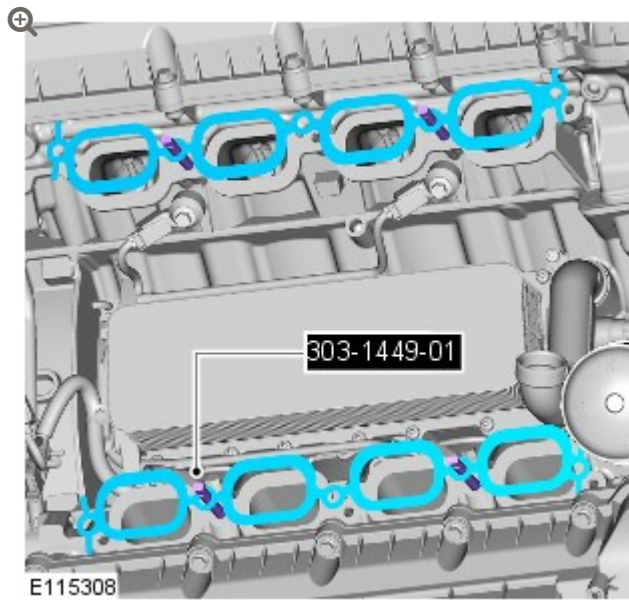

Install new supercharger-to-cylinder head gaskets.

21

CAUTION:

Make sure that the mating faces are clean and free of foreign material.

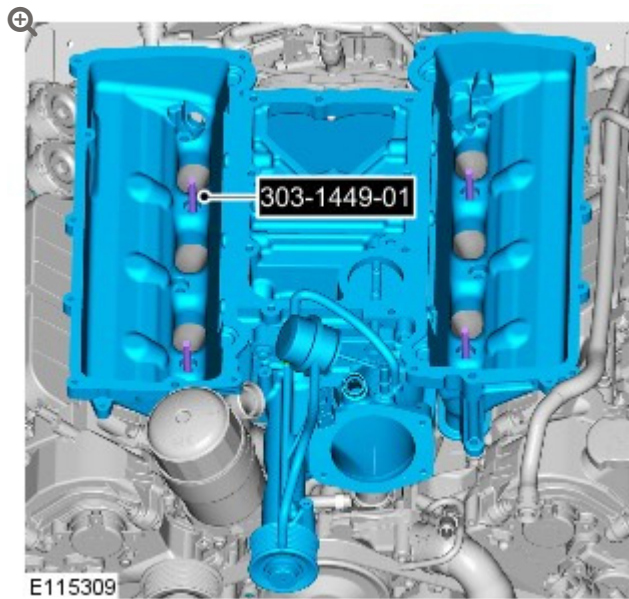

Install the supercharger assembly.

22

NOTE:

Left-side shown, right-side similar.

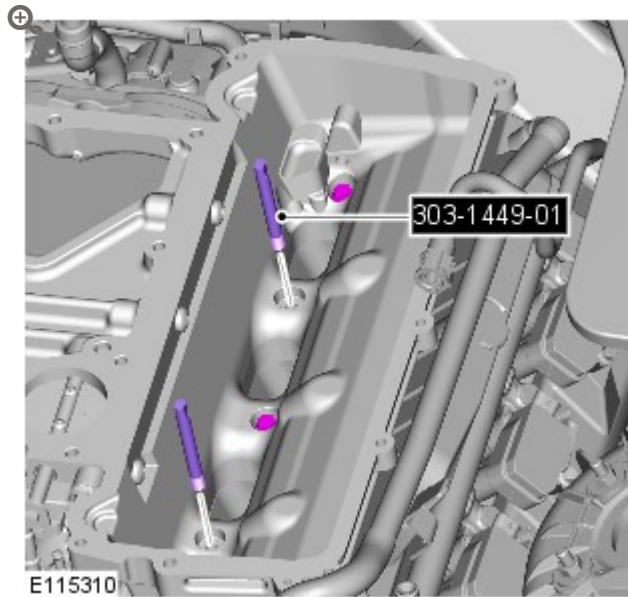

Install the fastener bolt.

- Torque: **25 Nm**.
- Repeat this step on the right side of the engine.
- Remove the guide pins from both sides.

23

NOTE:

Left-side shown, right-side similar.

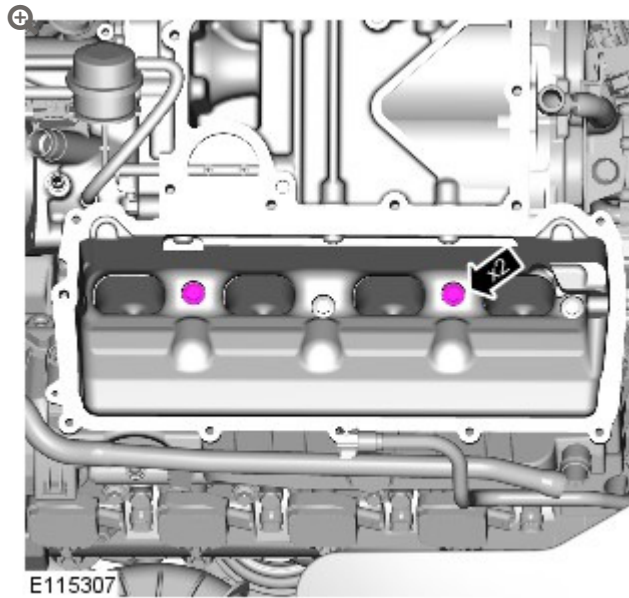

Install the two remaining fasteners into the locations where the guide pins had previously been installed.

- Torque: **25 Nm**.
- Repeat this step on the right side of the engine.

24

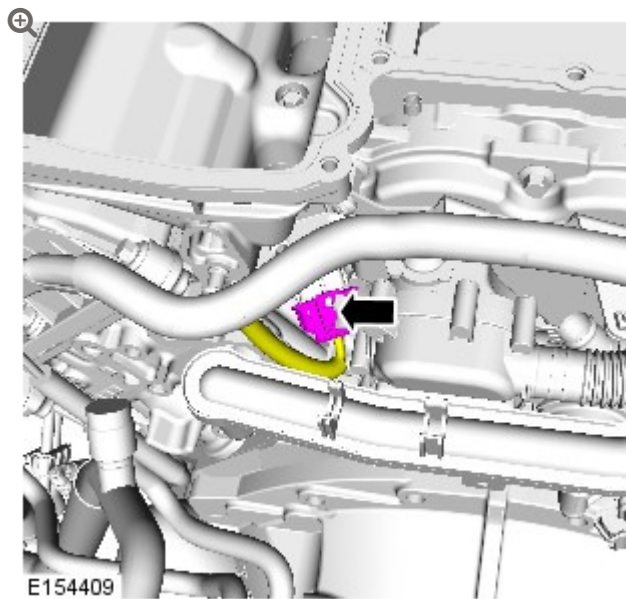

Install the wiring harness.

25

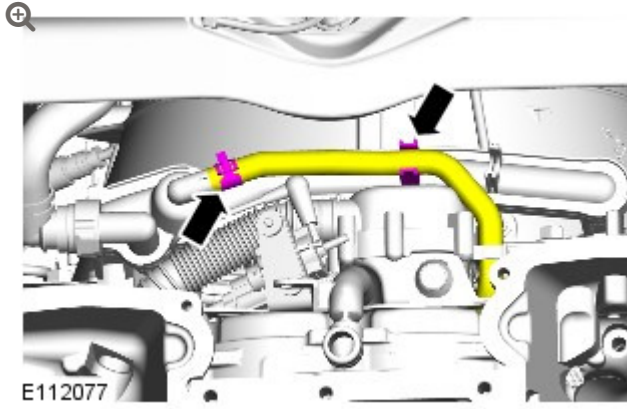

Install the hose.

26

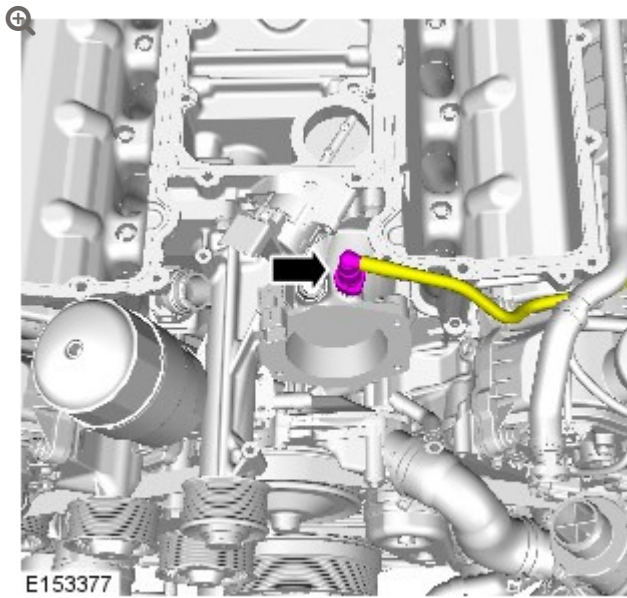

Install the hose.

27

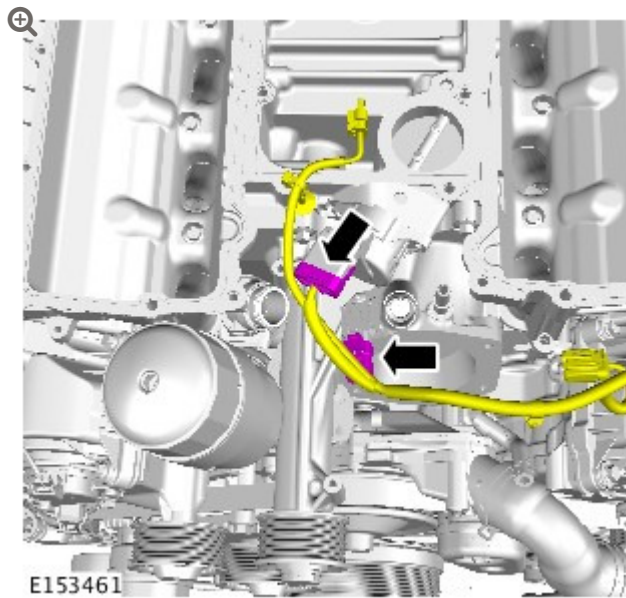

Install the wiring harness.

-
- 28** Install the supercharger belt (see TOPIx Workshop Manual section 303-05B: Accessory Drive - V8 S/C 5.0L Petrol, Removal and Installation).

29

CAUTIONS:

- Take extra care when installing the throttle body. Failure to follow this instruction may result in damage to the Manifold Absolute Pressure and Temperature (MAPT) sensor.
- Do not attempt to clean the throttle body bore, build up of deposits reduces air leakage past the throttle plate at the fully closed position.

NOTE:

Make sure to install a new gasket.

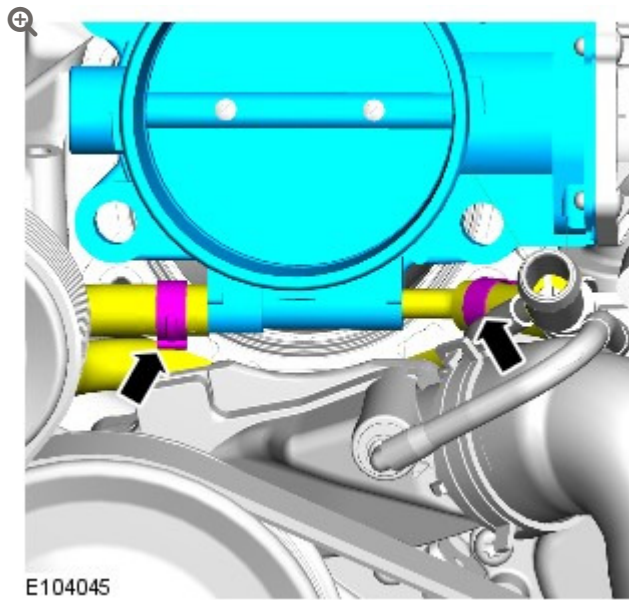

Install the throttle body and connect the pipes.

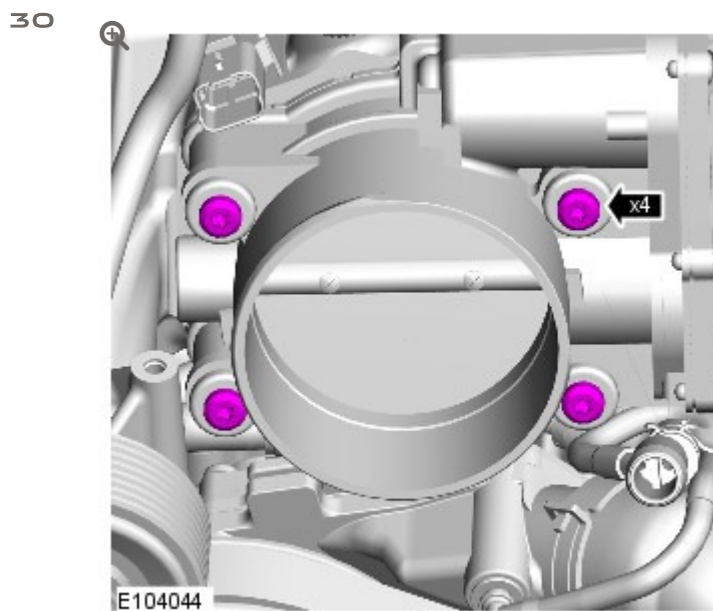

Install the throttle body fasteners.

- Torque: **10 Nm.**

31

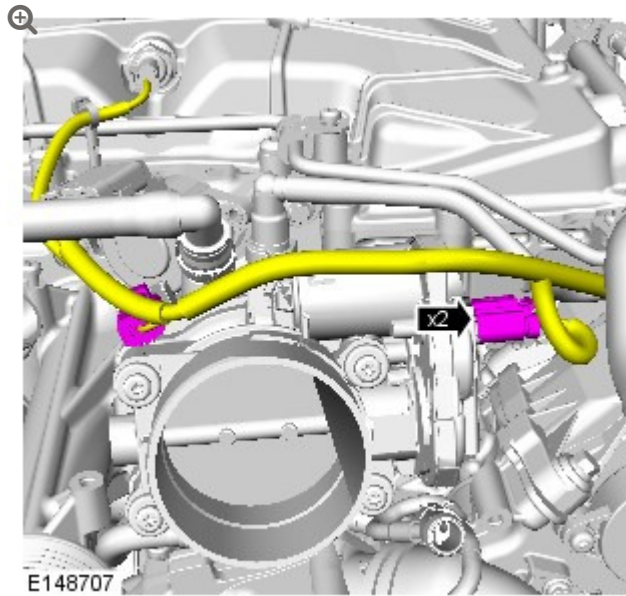

Install the wiring harness to the throttle body.

32

CAUTION:

When installing the new upper coolant pipe, make sure the O-ring is correctly installed.

NOTES:

- Make sure to retain the fasteners.
- The revised design of coolant pipe has no intermediate pipe between the upper and lower sections.

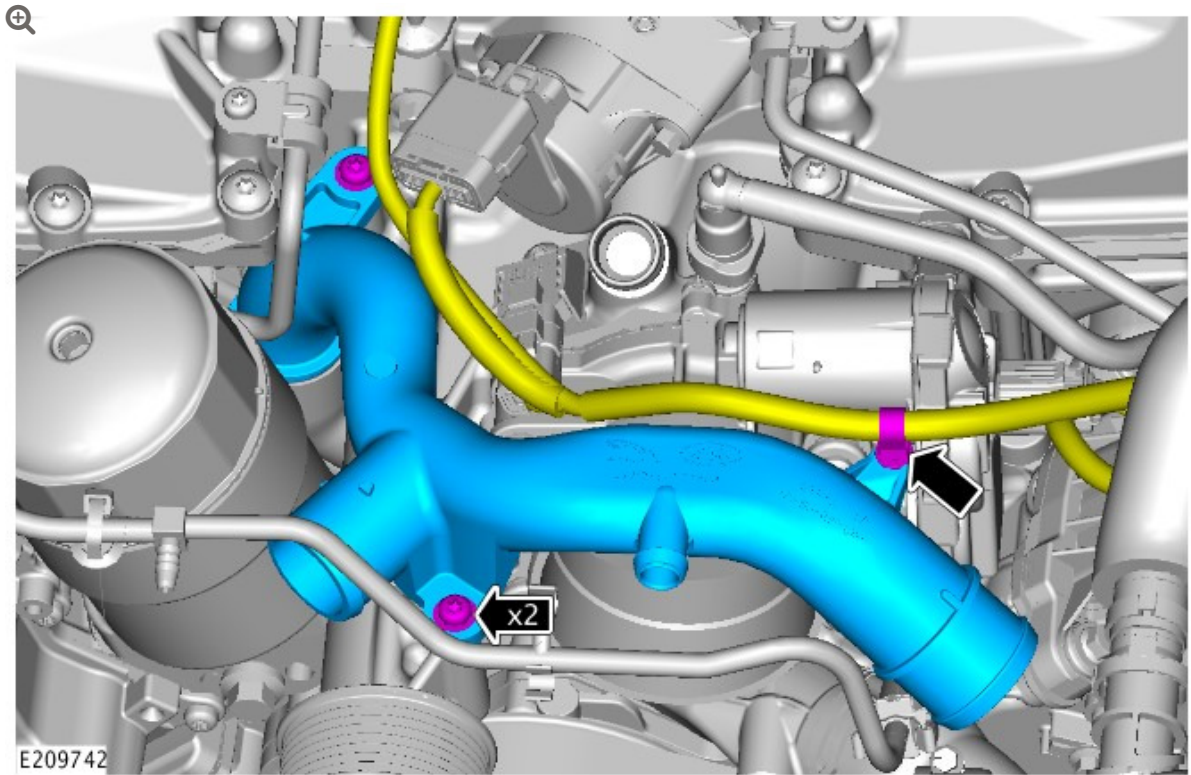

Install the replacement upper coolant outlet pipe.

- Clip the wiring harness to the pipe.
- Torque: **10 Nm**.

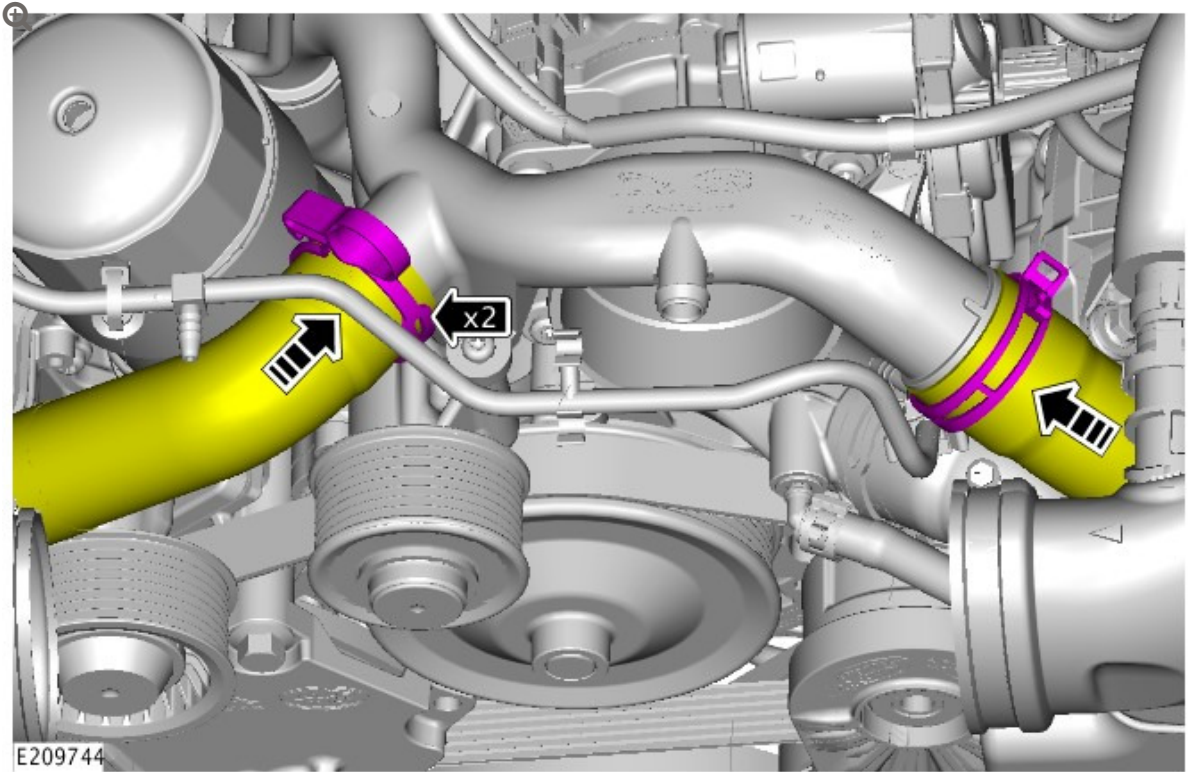

Install the 2 coolant hoses.

34

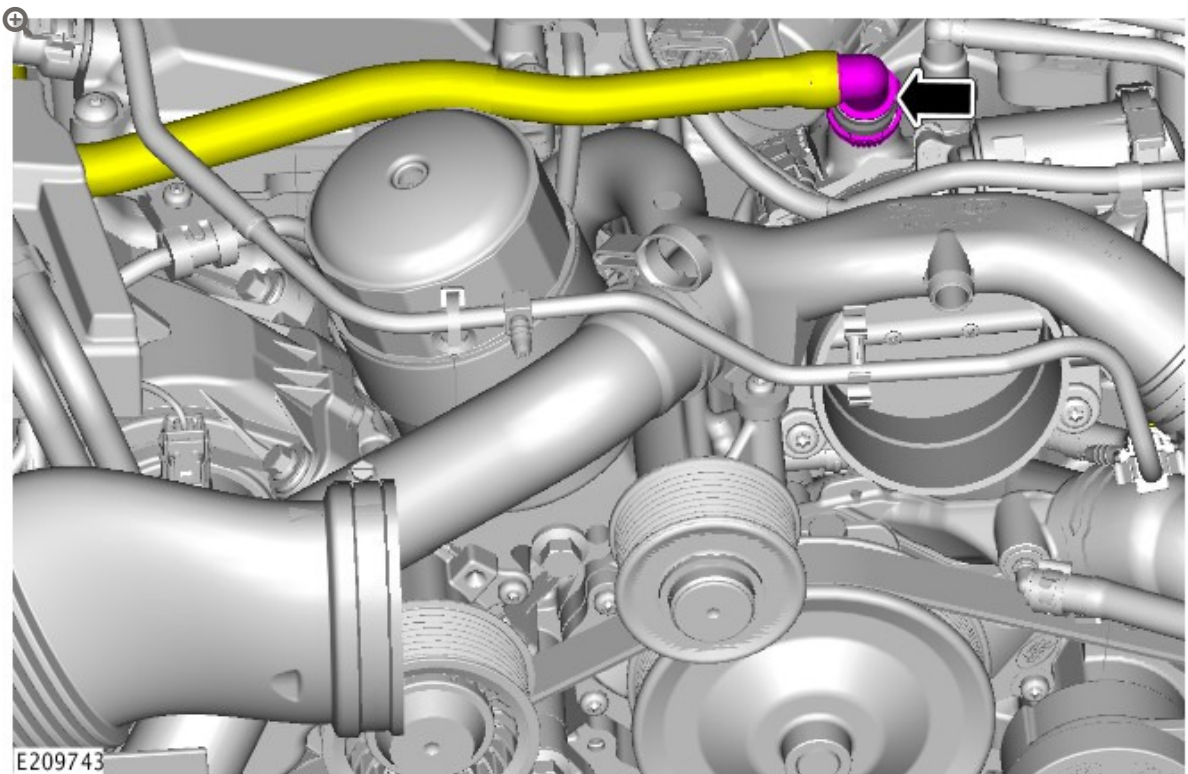

Install the hose

35

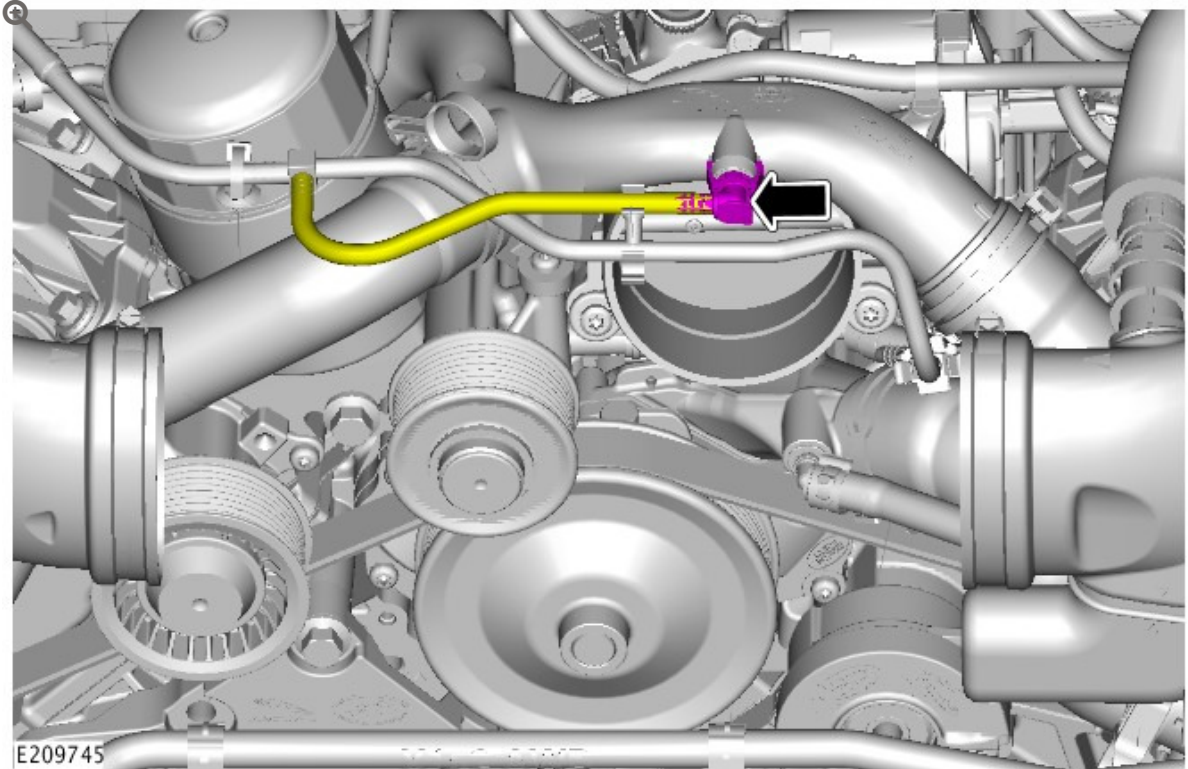

Install the hose

36 Install the air cleaner outlet pipe T-connector (see TOPIx Workshop Manual section 303-12: Intake Air Distribution and Filtering - Air Cleaner Outlet Pipe T-Connector).

37 Install the charge air cooler (see TOPIx Workshop Manual section 303-12: Intake Air Distribution And Filtering - Charge Air Cooler).