

Date	Group	No.	Release	Page
1.2018	<b>284</b>	<b>064</b>	<b>01</b>	1(7)

Engine Control Module (ECM) and  
Aftertreatment Control Module (ACM),  
Reprogramming  
CHU, CXU, GU, LEU, MRU, TD, PI, AN, GR,  
LR, TE,

## **FSB 284-064 Engine Control Module (ECM) and Aftertreatment Control Module (ACM), Reprogramming**

(January 2018)

### **Information**

Software updates with enhancements are available for the engine control module (ECM) and aftertreatment control module (ACM) for MACK MP7, MP8 and MP10 engines on OBD2015 vehicles built from January 1, 2015 to December 31, 2015.

**Note:** This bulletin does not apply to MACK Trucks Australia.

Follow the reprogramming procedure in the following order as outlined in this document:

- ECM reprogramming
- ACM reprogramming

The software updates address the following Diagnostic Trouble Codes (DTCs):

- P026C - Fuel Injector, Low Mass Flow
- P0507 – Idle Engine Speed Rationality: Idle Speed High
- P2002 – PM Filter Efficiency Monitor
- P0422 – Catalyst 2 Efficiency Below Threshold (Bank 1)
- P226D – Diesel Particulate Filter (DPF) Missing Substrate
- P249C – Time to Enter DEF (Diesel Exhaust Fluid) Dosing
- P208E – Aftertreatment Reagent Dosing Valve Clogged
- P2459 – To Frequent Regeneration
- P24A4 – DPF Restriction – Soot Accumulation Too High (Bank 1)
- P10FE – DPF Restriction – Soot Accumulation Moderately High (Bank 1)
- P226C – Boost Pressure Slow Response
- P249F – Excessive Time to Enter Closed Loop DPF Regeneration Control
- P24A0 – Closed Loop DPF Regeneration Control at Limit – Temperature Too Low
- P208A – Aftertreatment DEF Pump: Open Circuit
- P20CF – (AHI) Fuel Injector “A” Stuck Open
- P226C00 – Turbocharger Boost Control “A” Slow Response
- P205B – Aftertreatment DEF tank Temperature Sensor: Rationality Low
- P20128 - Engine Cooling System: Stuck Open or Leaking Thermostat Monitor

Check the current main software for ECM and ACM to determine the action required as shown in the table below.

<b>Action Required</b>		
<b>ECM</b>	<b>Main Software</b>	<b>Action Required</b>
MP7 / MP8	Equal or Less Than 22741784	Update to Latest Software
MP10	Equal or Less Than 22644017	Update to Latest Software
<b>ACM</b>	<b>Main Software</b>	<b>Action Required</b>
MP7 / MP8 / MP10	Equal or Less Than 22741796	Update to Latest Software

## Required Tools

Premium Tech Tool (PTT) version 2.06.35 or higher

Vocom Diagnostic Connector 88890304

Communication Interface 88890300

**Note:** Using other interfaces may affect programming speed.

**Note:** Check Premium Tech Tool version by clicking on Help tab and then click on "About Tech Tool".

## Software Update Procedure

You must read and understand the precautions and guidelines in Service Information, group 20, "General Safety Practices, Engines" before performing this procedure. If you are not properly trained and certified in this procedure, ask your supervisor for training before you perform it.

### DANGER

Do not attempt to repair or service this vehicle without having sufficient training, the correct service literature and the proper tools. Failure to follow this could make the vehicle unsafe and lead to serious personal injury or death.

- 1 Park the vehicle on a level surface.
- 2 Apply the parking brake.
- 3 Place the transmission in neutral or park.
- 4 Install the wheel chocks.

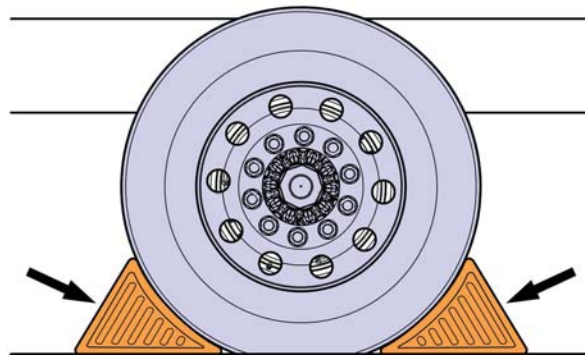

W7086748

- 5 Connect Premium Tech Tool (PTT) to the vehicle diagnostics connector using the 16 pin OBD cable 88890304 and Communication Interface 88890300. Connect the PC to a functional LAN or modem connection and a 120 Volt AC source.

- 6 Turn the ignition switch “ON”.
- 7 Log in to PTT and Identify Vehicle is displayed.
- 8 Once the vehicle has been identified, enter the Work Order Number information, then click Start Work.

Work Order Number

Enter a work order number or select a recently used work order number in the list.

Enter work order number:

Select a recently used work order:

Work Order No	User ID	Date
---------------	---------	------

Enter Notes:

Start Work Cancel

W2115477

- 9 From the Main Menu select Program and **then** Program Electronic Control Unit 1700-08-03-39. Then click Start.

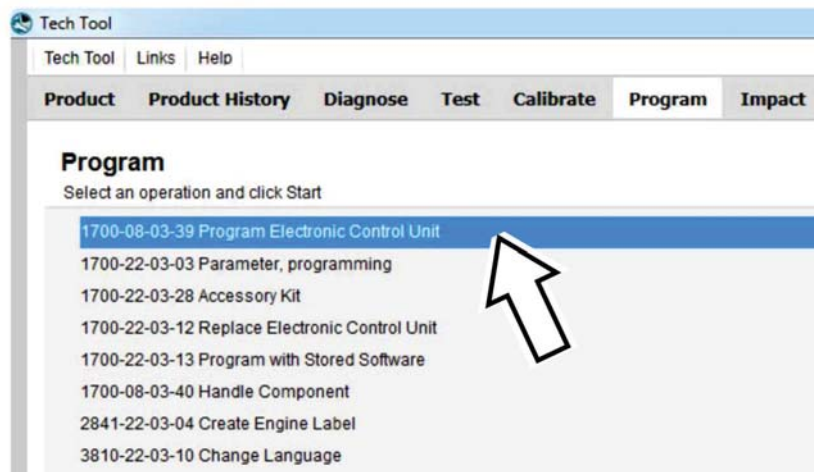

W2115478

10 Select **Engine Control Module (EMS)**.

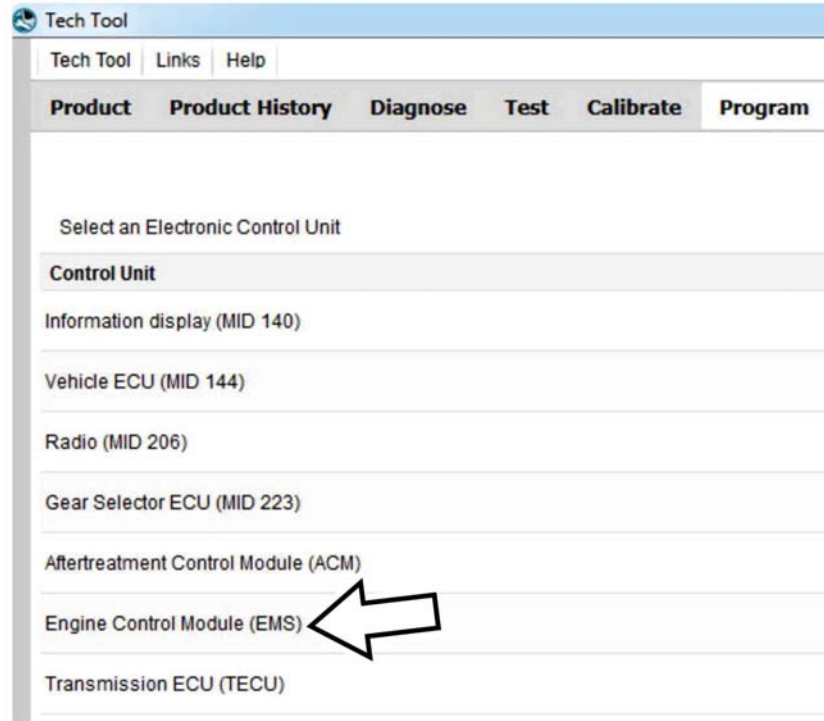

W2115479





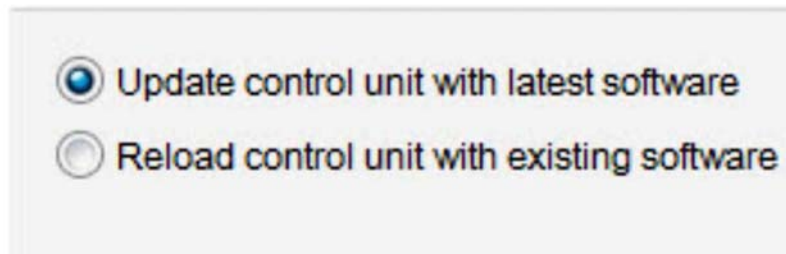





11 Select Program to update the **ECM** with the latest software.

## Programming options



W2115480

12 Certain conditions must be met to continue with programming: battery voltage above 10v, parking brake applied, and ignition key in ON position with engine not running. When all conditions have been met, click Continue to proceed with programming.

1	 > 10 V	12.7 V	
2	  		
3	  = 0 rpm	 0 rpm	

---

**1700-08-03-39 Program control unit - Update software**

---

Automatically checked conditions

- 1 Battery voltage above 10 V
- 2 Parking brake applied
- 3 Ignition key in **ON** position. Engine not running

W2115481

13 Select "I accept" to agree to the terms and press continue to proceed.

**Note:** In the United States and Canada, the programming is NOT chargeable. An invoice will not be generated.

**1700-08-03-39 Program control unit - Update software**

---

The following control units will be programmed

**Engine Control Module (EMS)**

Chargeable programming

The software you are about to program is chargeable. If programming is performed using the software, an invoice will be generated.

Programming will be charged once even if multiple retries are needed.

The software has commercial part number

**85136079** : Engine Control Module

The number can be used for price lookup in your local system and will be specified on the invoice.

I accept 

Select I accept to agree to the terms Press Continue to proceed

W2115482

- 14 When programming is complete, click Exit to return to Main Menu to program the ACM.
- 15 When all programming is complete, clear any diagnostic trouble codes (DTC) and Finish Work.
- 16 Remove the wheel chocks.

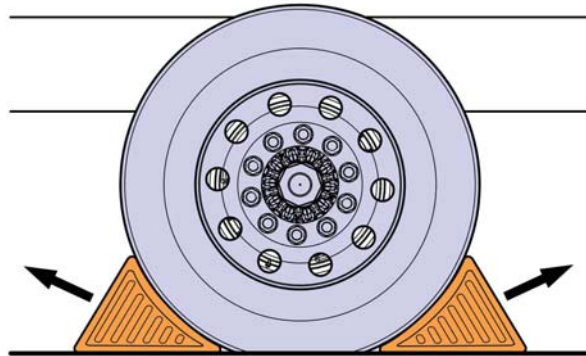

W7086759

**Reimbursement**

<p><b>This repair may be eligible for reimbursement if a product failure was experienced within time and mileage limits of the applicable Warranty coverage. Reimbursement is obtained via the normal claim handling process.</b></p>	<p><b>UCHP Reimbursement</b></p>
<p><b>Claim Type (used only when uploading from the Dealer Bus. Sys.)</b></p>	<p>01</p>
<p><b>Labor Code</b></p>	<p style="background-color: #cccccc;"></p>
<p>Primary Labor Code (Engine Control Module (ECM) and Aftertreatment Control Module (ACM), Reprogramming)</p>	<p>2841-22-09-16                  0.4 hrs.</p>
<p><b>Causal Part</b></p>	<p>3092091</p>

MACK Trucks North America reserves the right to make any changes in design or to make additions to or upon its products without incurring any obligations to install the same on vehicles previously built.