

Technical Support Guide

Gen 2.0 & 2.1 Micro SD Navigation (AVN) Display Audio (DA)

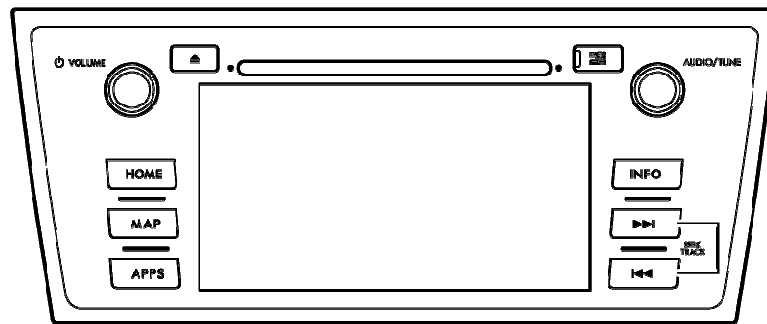

AVN (with Navigation)

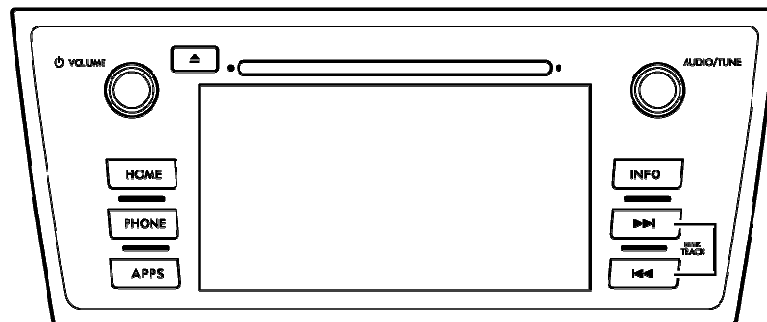

Display Audio (without Navigation)

Technical Support Guide

Gen 2.0 & 2.1 Micro SD Navigation (AVN)
Gen 2.0 & 2.1 Display Audio (DA)

Contents

1. Introduction of Gen 2.0 & 2.1 Audio/Navigation System

- System Types	4
- Part Number Information	5-8
- Summary of Features.....	9
- Main Screens (AVN/Display Audio)	10-11
- APPS Function	12-13
- INFO Function	14
- Navigation Function	15
- Audio/Visual Functions	16-21

2. Troubleshooting

- System Diagram (AVN/Display Audio)	22-23
- Connections and Pins	24-27
- On-Board Diagnostic Mode	28-30
- No power, No sound (All modes) with Internal & External Amp.	31-33
- No sound (AM/FM)/Volume fades up and down (AM/FM/HD)	34-35
- No sound (SAT), (CD), (USB), (AUX), (iPod)	36-40
- CD skip, CD won't play correctly	41-42
- Sound is poor or noisy, No illumination	43-44
- No Map is displayed (NAV UNIT ONLY)	45
- Poor or no response from touch screen	46
- Current GPS position does not move	47
- Bluetooth does not work	48
- Rear View Camera won't display (NAV/Non NAV)	49-50
- STARLINK	51-53
- Mirrorlink	54
- aha Radio	55-72
- Pandora Radio	73-84
- DCM / Siri	85-88

3. Frequently Asked Questions (FAQ)

- Navigation	89-90
- Bluetooth Hands-free	91-92
- Audio/Visual	93-96
- APPS, INFO, Voice Recognition and Others	97-101
-STARLINK.....	102-118

4. Glossary

- [A] - [S]	119-120
- [U] - [number]	121

1. Introduction of Audio/Navigation System

System Types

(1) AVN (with Navigation)

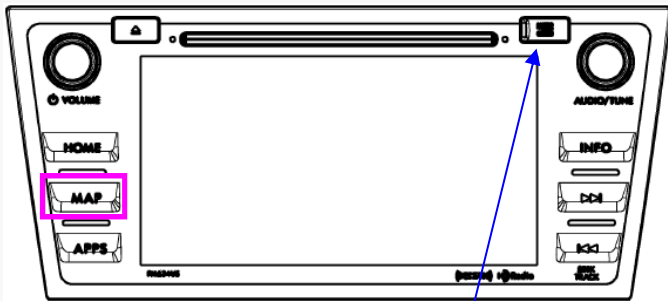

Micro SD card
(Map data only)

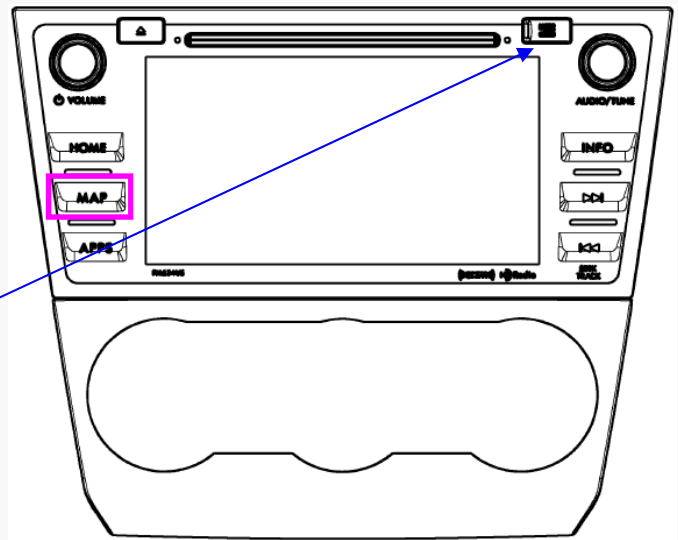

(2) Display Audio (without Navigation)

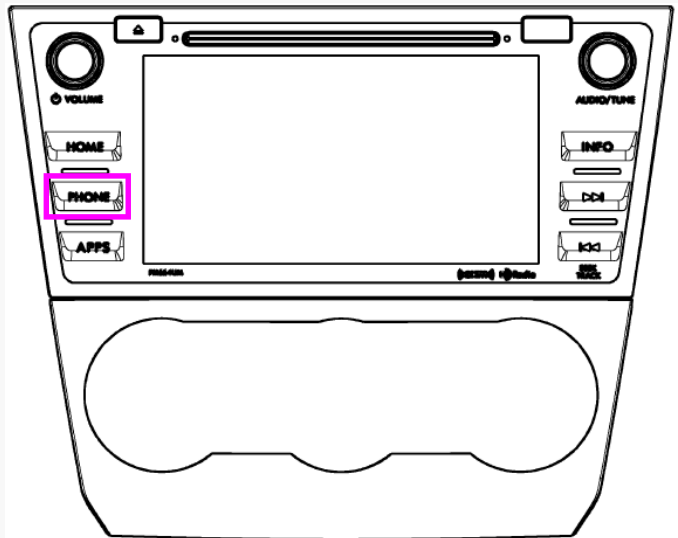
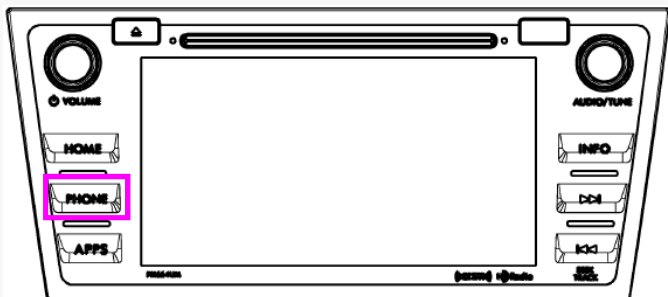

1. Introduction of Audio/Navigation System

Part Number Information

(1) AVN (with Navigation) USA

Note: Cannot swap units between model year

Country	Gen	Vehicle	Subaru Part No.	Face ID	Navi Map	Amplifier	DCM Connection
USA	2	2015 Legacy	86271AL66*	FB664US	micro SD	External AMP	No
		2015 Outback	86271AL64*	FB644US	micro SD	Built-in AMP	
		2015 Impreza	86271FJ63*	FM634US	micro SD	Built-in AMP	No
		2015 Crosstrek XV					
		2016 WRX	86271VA63*	FV631US	micro SD	External AMP	No
		2016 Forester	86271SG68*	FF687US	micro SD	External AMP	Yes
			86271SG66*	FF667US	micro SD	Built-in AMP	
	2.1	2016 Legacy	86271AL69*	FB695US	micro SD	External AMP	Yes
			2016 Outback	86271AL68*	FB685US	micro SD	
		2016 Impreza	86271FJ65*	FM655UH	micro SD	Built-in AMP	Yes
		2016 Crosstrek XV	86271FJ67*	FM675UH	micro SD	Built-in AMP	No
			2017 Crosstrek	86271FJ68*	FM686US	micro SD	Built-in AMP
		86271FJ66*		FM666US	micro SD	Built-in AMP	Yes
		2017 Forester	86271SG87*	FF878US	micro SD	External AMP	Yes
			86271SG86*	FF868US	micro SD	Built-in AMP	Yes
		2017 WRX	86271VA64*	FV642US	micro SD	External AMP	Yes
		2017 Legacy	86271AL87*	FB876US	micro SD	External AMP	Yes
		2017 Outback	86271AL85*	FB856US	micro SD	Built-in AMP	Yes
		2018 Forester	86471SG63*	FF639US	micro SD	External AMP	Yes
			86471SG62*	FF629US	micro SD	Built-in AMP	Yes
2018 WRX	86271VA67*	FV673US	micro SD	External AMP	Yes		

* Any numbers or letters such as 0, 1, 2, A and B

1. Introduction of Audio/Navigation System

Part Number Information

(1) AVN (with Navigation) Canada

Note: Cannot swap units between model year

Country	Gen	Vehicle	Subaru Part No.	Face ID	Navi Map	Amplifier	DCM Connection
Canada	2.0	2015 Legacy 2015 Outback	86271AL67*	FB674CS	micro SD	External AMP	No
		2015 Impreza 2015 Crosstrek XV	86271FJ73*	FM734CS	micro SD	Built-in AMP	No
		2016 WRX	86271VA73*	FV731CS	micro SD	External AMP	No
		2016 Forester	86271SG78*	FF787CS	micro SD	External AMP	No
			86271SG76*	FF767CS	micro SD	Built-in AMP	
		2.1	2016 Legacy 2016 Outback	86271AL65*	FB655CS	micro SD	External AMP
	2016 Impreza 2016 Crosstrek XV		86271FJ75*	FM755CH	micro SD	Built-in AMP	No
	2017 Crosstrek		86271FJ76*	FM766CS	micro SD	Built-in AMP	No
	2017 Forester		86271SG85*	FF858CS	micro SD	External AMP	No
	2017 Legacy 2017 Outback		86271AL86*	FB866CS	micro SD	External AMP	No
	2017 WRX		86271VA74*	FV742CS	micro SD	External AMP	No
	2018 Forester		86471SG72*	FF729CS	micro SD	External AMP	No
	2018 WRX		86271VA76*	FV763CS	micro SD	External AMP	No

* Any numbers or letters such as 0, 1, 2, A and B

1. Introduction of Audio/Navigation System

Part Number Information

(1) AVN (with Navigation) USA/Canada

Map Micro SD Card Part Number



Vehicle	Subaru Part No.	Map Version
2015 Legacy 2015 Outback	86283AL66A	2013 Q3
2015 Impreza	86283FJ630	
2015 XV Crosstrek		
2016 WRX		
2016 Forester		
2016 Legacy 2016 Outback	86283AL68A	2013 Q3
2016 Impreza 2016 XV Crosstrek 2017 Forester 2017 WRX	86283FJ650	2014 Q3
2017 Legacy 2017 Outback	86283AL85A	2014 Q3
2017 Crosstrek 2018 Forester 2018 WRX	86283FJ660	2015 Q3

The latest Map Micro SD Card is available at SOP.

1. Introduction of Gen II Audio/Navigation System

Part Number Information

(2) Display Audio (without Navigation) USA/Canada

Note: Cannot swap units between model year

Country	Gen	Vehicle	Subaru Part No.	Face ID	Amplifier	DCM Connection
USA	2.0	2015 Legacy	86201AL66*	FB664UM	External AMP	No
		2015 Outback	86201AL64*	FB644UM	Built-in AMP	
		2015 Impreza	86201FJ66*	FM664UM	Built-in AMP	No
		2015 Crosstrek XV				
		2016 WRX	86201VA65*	FV651UM	External AMP	No
		2016 Forester	86201SG68*	FF687UM	External AMP	Yes
	86201SG66*		FF667UM	Built-in AMP		
	2.1	2016 Legacy	86201AL69*	FB695UM	External AMP	Yes
			2016 Outback	86201AL68*	FB685UM	
		2016 Impreza	86201FJ68*	FM685UM	Built-in AMP	Yes
			2016 Crosstrek XV	86201FJ70*	FM705UM	Built-in AMP
		2017 Forester	86201SG69*	FF698UM	External AMP	Yes
			86201SG67*	FF678UM	Built-in AMP	Yes
		2017 WRX	86201VA67*	FV672UM	Built-in AMP	Yes
			86201VA66*	FV662UM	External AMP	Yes
		2017 Legacy	86201AL87*	FB876UM	External AMP	Yes
			2017 Outback	86201AL85*	FB856UM	Built-in AMP
		2018 Forester	86431SG68*	FF689UM	External AMP	Yes
86431SG67*			FF679UM	Built-in AMP	Yes	
2018 WRX	86201VA84*	FV843UM	External AMP	Yes		
	86201VA83*	FV833UM	Built-in AMP	Yes		
Canada	2.0	2015 Legacy	86201AL67*	FB674CM	External AMP	No
		2015 Outback				
	2.1	2015 Impreza	86201FJ76*	FM764CM	Built-in AMP	No
		2015 Crosstrek XV				
		2016 Legacy				
2016 Outback						
2017 Legacy	86201AL86*	FB866CM	External AMP	No		
2017 Outback	86201AL84*	FB846CM	Built-in AMP	No		

* Any numbers or letters such as 0, 1, 2, A and B

1. Introduction of Gen II Audio/Navigation System

Summary of Features

Features		AVN (with Navi)	Display Audio (w/o Navi)
Display	TFT Size (resolution)	7-inch WVGA (800x480)	7-inch WVGA (800x480)
	Touch Panel	Electro-Static Type	Electro-Static Type
HMI	Screen Design	Customized	Customized
	Vehicle Settings	Customized	Customized
Audio	AM/FM (RBDS)	Yes	Yes
	HD Radio	*Yes	*Yes
	Sirius XM	Yes	Yes
	DVD	N/A	N/A
	CD	Yes (single CD)	Yes (single CD)
	AUX	Yes	Yes
	USB/iPod/iPhone	Yes	Yes
	BT-Audio	Yes	Yes
	SD-Audio	Yes	No
	Harman Audio AMP	Yes (if equipped)	Yes (if equipped)
Video	USB/Micro SD/iPod-iPhone	Yes / Yes / No	Yes / No / No
Phone	Bluetooth Hands-free	Yes	Yes
Navigation	Navigation Supplier	NNG	N/A
	Navigation Media	Micro SD Card (8GB)	N/A
	Traffic Info	***Sirius XM Traffic	N/A
	Map Update	TBD	N/A
Voice Recognition		Yes	Yes
Rear View Camera		Yes	Yes
Rear Seat Entertainment (RSE)		N/A	N/A
Connectivity	STARLINK & Aha	Yes	Yes
	MirrorLink	Yes	Yes
	Pandora	*Yes	*Yes
	Stitcher	**Yes	**Yes
	Sirius XM Data Service	***Yes	***Yes
Communication	CAN/UART	****Yes	****Yes
	DCM (Data Communication Module)	*****Yes	*****Yes

*Not available for Canadian model

** Available for 2016 Legacy/Outback

***Not available for Gen 2.0 Canadian model. Available for Gen 2.1 Canadian model except Fuel Service.

****Available for 2015 and 2016 Legacy/Outback

***** Available for 2016 Forester and Legacy/Outback (Except Canadian Model)

1. Introduction of Gen II Audio/Navigation System

Main Screens

(1) AVN (with Navigation)

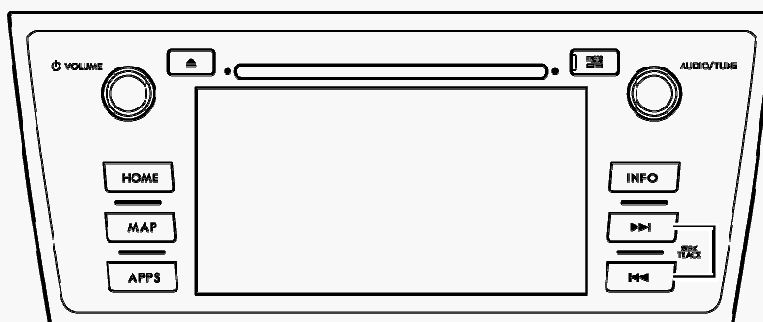

HOME Screen

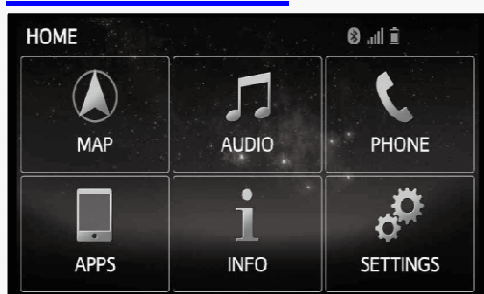

- MAP: Navigation MAP
- Audio: List of Audio Sources
- Phone: Bluetooth Hands-free call
- APPS: STARLINK, MirrorLink, aha, *Pandora
- INFO: **Sports, **Weather, **Stocks, **Fuel
- SETTINGS: General Settings

APPS Screen

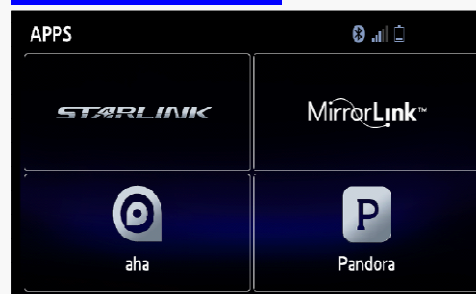

- APPS (Applications) needs to be installed on user's smartphone
- Smartphone communicates with the unit via USB or Bluetooth connection
- Smartphone communicates with internet via wireless network (Wifi, 3G, 4G, 4G LTE)
- (Pandora: Not available for Canadian model)

MAP Screen

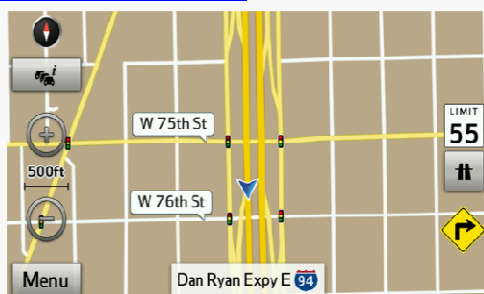

- MAP data is stored in the micro SD card
- GPS, Gyro and Speed signal are used to locate the current vehicle position
- Traffic information is provided by Sirius XM Radio Data Service**
- Subscription is necessary for Sirius XM Radio Data Service**

*Not available for Canadian model

**Not available for Gen 2.0 Canadian model. Available for Gen 2.1 Canadian model except Fuel Service.

***Available for 2015 and 2016 Legacy/Outback

INFO Screen

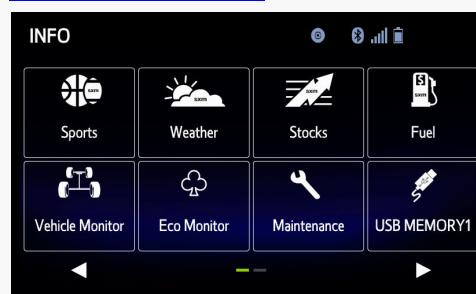

- Information of Sports, Weather, Stocks and Fuels is provided by Sirius XM Radio Data Service**
- Subscription is necessary for Sirius XM Radio Data Service*
- Information of Vehicle Monitor and Eco Monitor is fed via Vehicle ECU with CAN communication***

1. Introduction of Gen II Audio/Navigation System

Main Screens

(2) Display Audio (without Navigation)

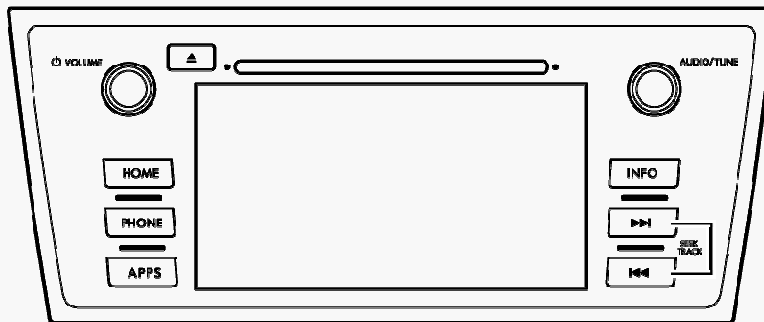

HOME Screen

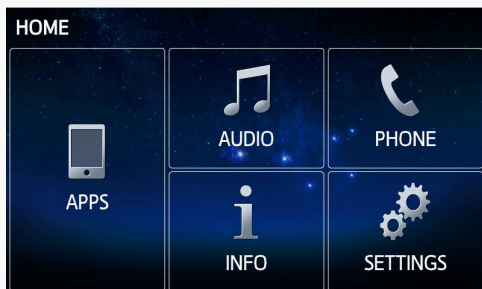

- Audio: List of Audio Sources
- Phone: Bluetooth Hands-free call
- APPS: STARLINK, MirrorLink, aha, *Pandora
- INFO: **Sports, **Weather, **Stocks, **Fuel
- SETTINGS: General Settings

APPS Screen

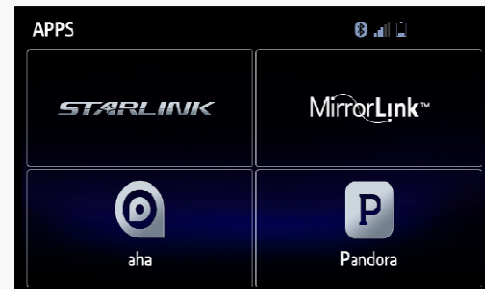

- APPs (Applications) needs to be installed on user's smartphone
- Smartphone communicates with the unit via USB or Bluetooth connection
- Smartphone communicates with internet via wireless network (Wifi, 3G, 4G, 4G LTE)

(Pandora: Not available for Canadian model)

Phone Screen



- <http://www.subaru.com/owners/vehicle-resources.html?bluetooth=true> for phone compatibility information
- Phone needs to have HFP (Hands-free Profile) for Bluetooth Hands-free calls
- Phone needs PBAP (Phonebook Access Profile) or OPP (Object Push Profile) for phone contacts transfer

*Not available for Canadian model

**Not available for Gen 2.0 Canadian model. Available for Gen 2.1 Canadian model except Fuel Service.

***Available for 2015 and 2016 Legacy/Outback

INFO Screen

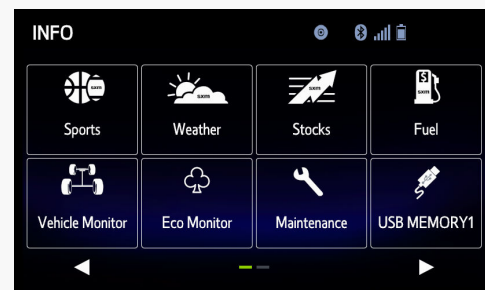

- Information of Sports, Weather, Stocks and Fuels is provided by Sirius XM Radio Data Service**
- Subscription is necessary for Sirius XM Radio Data Service*
- Information of Vehicle Monitor and Eco Monitor is fed via Vehicle ECU with CAN communication***

1. Introduction of Gen II Audio/Navigation System

APPS Function

STARLINK, MirrorLink, aha, Pandora

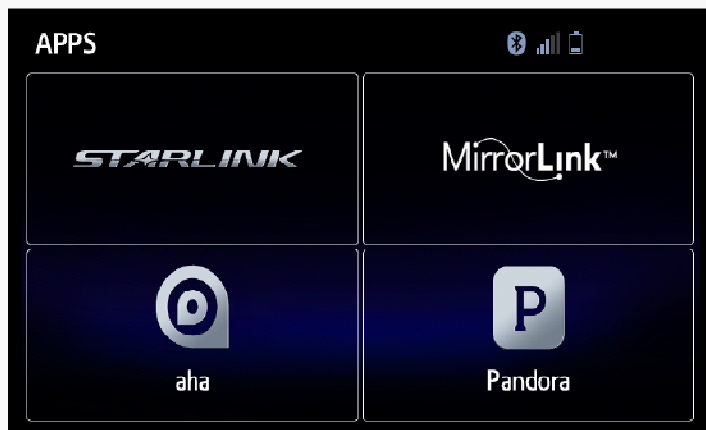

To operate a APPS function

- App (application) needs to be installed on user's smartphone
- Smartphone needs to connect with the unit via USB or Bluetooth depending on phone models and application being used
- Smartphone requires the mobile data plan
- Smartphone needs to connect to the internet via wireless network (3G, 4G, 4GLTE or Wifi)

Pandora: Not available for Canadian model

Communication

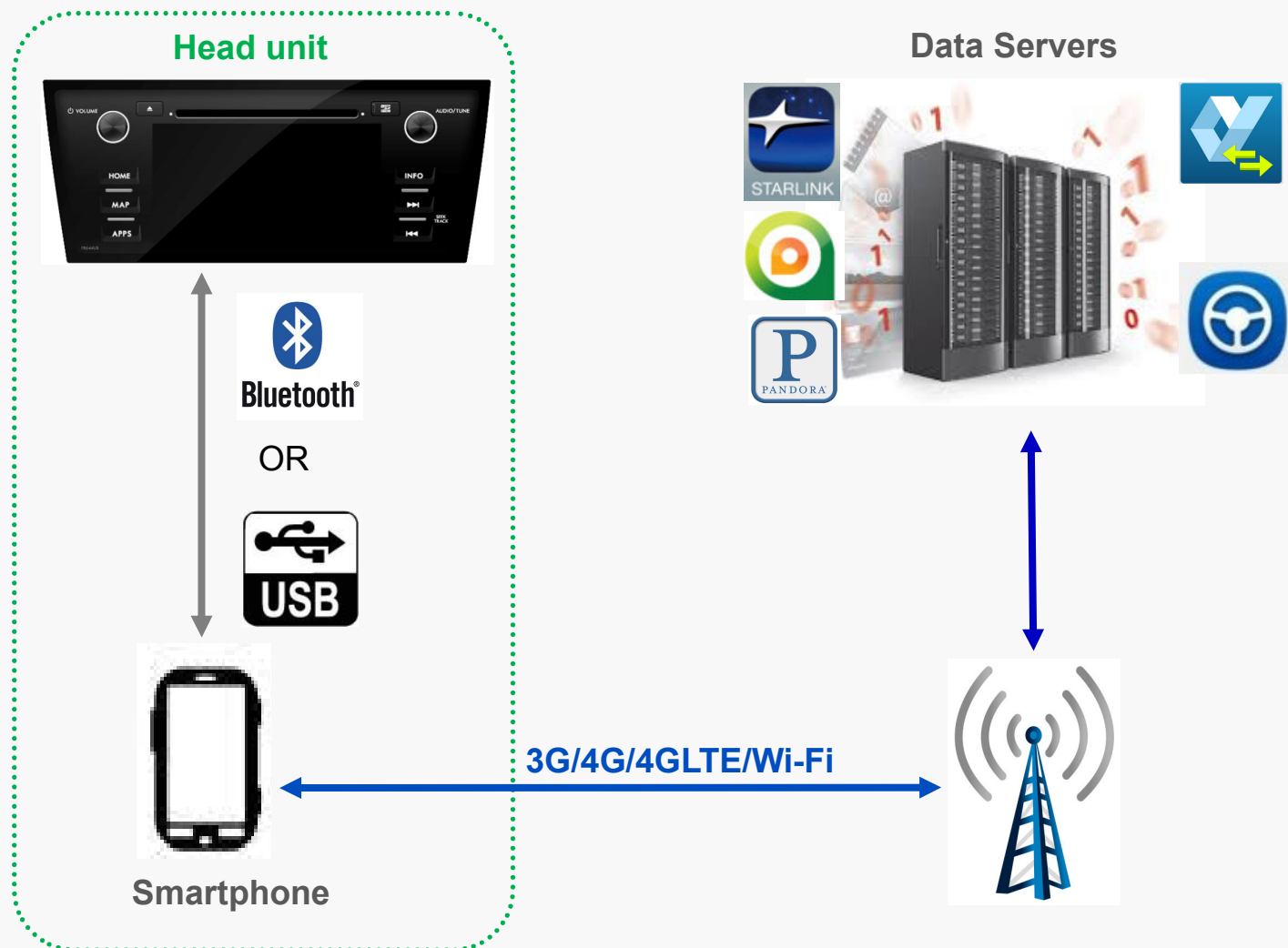

1. Introduction of Gen II Audio/Navigation System

APPS Function

STARLINK Screen**

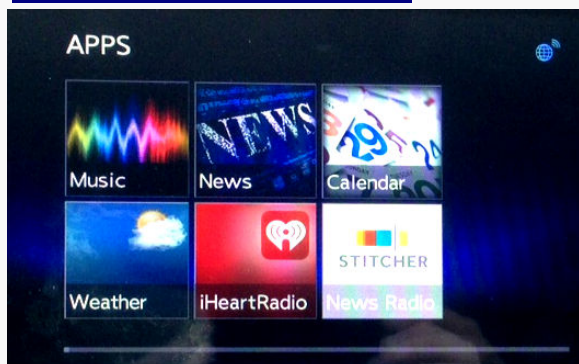

MirrorLink Screen

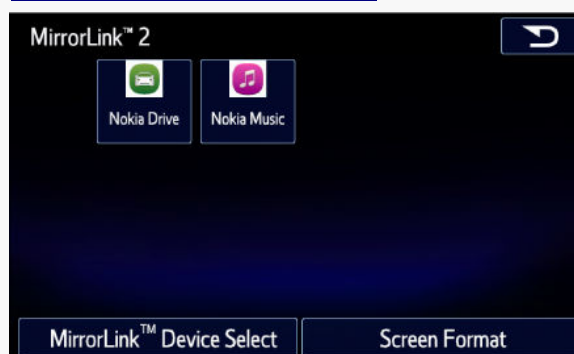

Aha Screen

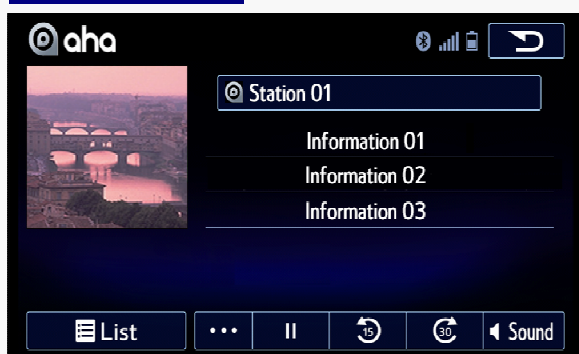

Pandora Screen*

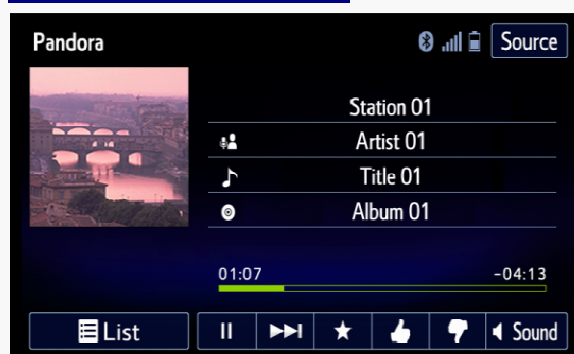

APPs, Supported Device, Connection Method

Features	App for Smartphone	Supported Device	Connection Method to Unit
STARLINK	STARLINK	iPhone: iOS 4.3.5 or later Android: Android 4.0 or later	iPhone: USB (Gen 2.0) and Bluetooth (Gen 2.1) Android: Bluetooth
MirrorLink	Refer to Mirror Link Website (http://www.mirrorlink.com/apps)	Refer to Owner's Manual (P141 for Gen 2.0, P151 for Gen 2.1)	USB
aha	aha	iPhone: iOS 5.0 or later Android: Android 2.2 or later	iPhone: USB Android: Bluetooth
*Pandora	Pandora	iPhone: iOS 5.0 or later Android: Android 2.2 or later	iPhone: USB Android: Bluetooth

*Not available for Canadian model

** Check the availability of Apps at <https://www.subaru.com/engineering/starlink.html>

1. Introduction of Gen II Audio/Navigation System

INFO Function

Sports, Weather, Stocks, Fuel

INFO Screen

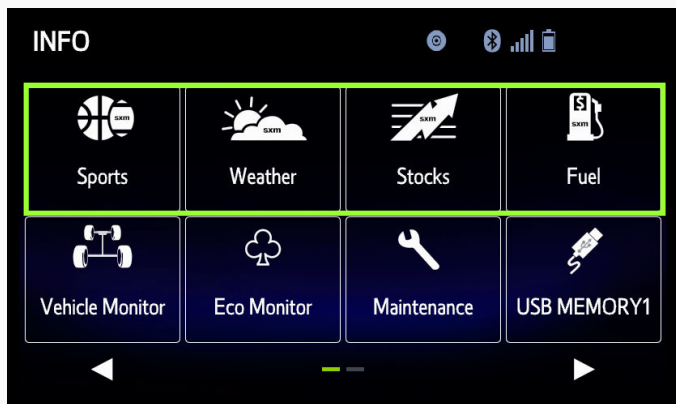

Not available for Gen 2.0 Canadian model. Available for Gen 2.1 Canadian model except Fuel Service

- Information of Sports, Weather, Stocks and Fuel is provided by Sirius XM Radio Data Service
- Subscription is necessary for Sirius XM Radio Data Service
- For AVN user's current location will be determined by GPS signals for the Weather and Fuel information
- For Display Audio the desired location for the Weather and Fuel information will be setup on the unit by the user

Vehicle Monitor, Eco Monitor

Vehicle Monitor Screen

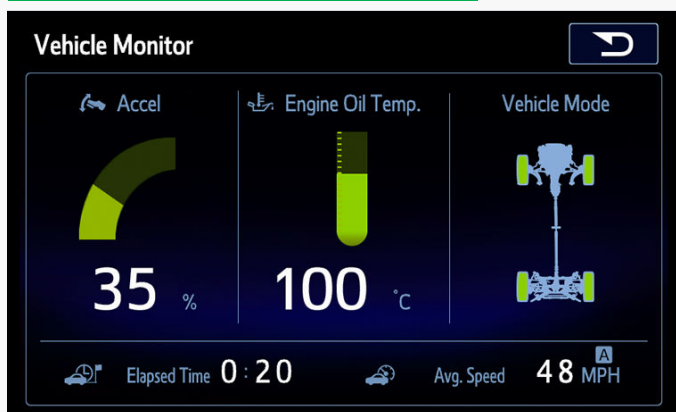

Eco Monitor Screen

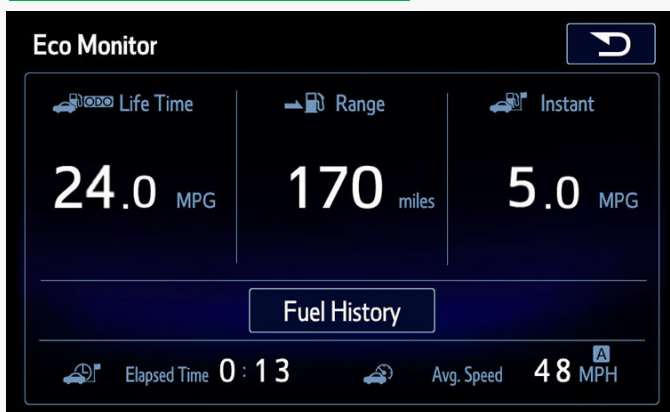

Information is fed via Vehicle ECU with CAN communication (Available for 2015 and 2016 Legacy/Outback)

STARLINK Safety and Security services

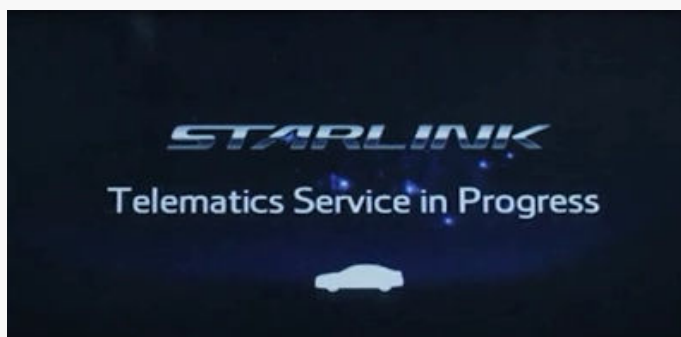

Available for 2016 Forester and Legacy/Outback (USA Model only)

1. Introduction of Gen II Audio/Navigation System

Navigation Function

Navigation Features

MAP Screen

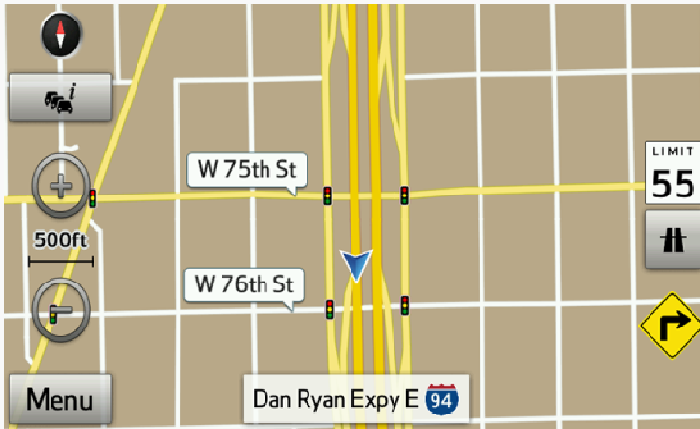

- Current position is calculated by GPS, Gyro and Speed signals
- Current positioning error is up to 300ft (100m)
- Map data is stored in micro SD card (8GB)
- Traffic information displayed on the Map is fed via Sirius XM Radio Data Service*
- Subscription is necessary for Sirius XM Data Service*

*Not available for Gen 2.0 Canadian model. Available for Gen 2.1 Canadian model

GPS Signal Indicator Screen

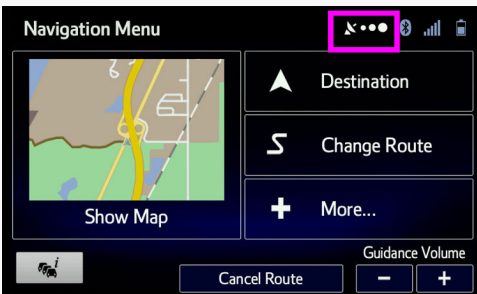

Good GPS Reception

Poor GPS Reception

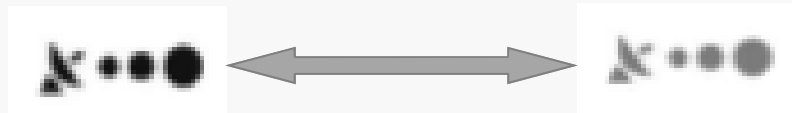

Voice Recognition Screen

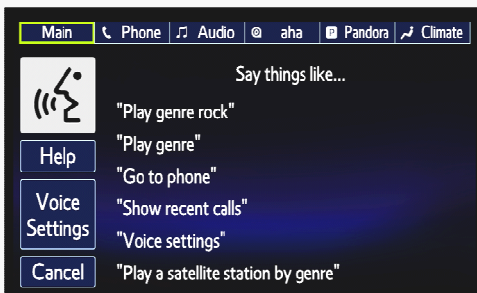

- Able to control navigation functions by voice commands
- To control Navigation by voice commands, TTS Voice must be selected

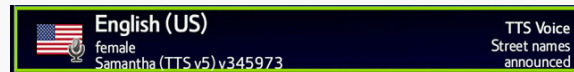

CAUTION Screen

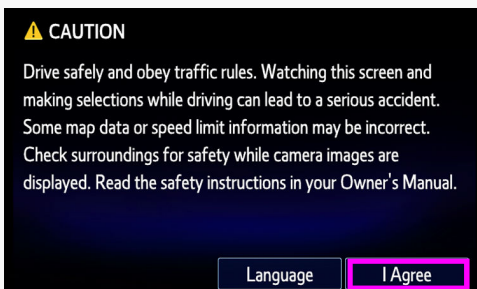

- "Caution" screen will be disappeared if "I Agree" button is not pressed within 5 seconds

1. Introduction of Gen II Audio/Navigation System

Audio/Visual Functions

AM, FM, Sirius XM, aha, *Pandora, CD, Bluetooth Audio, USB, iPod, micro SD

Audio Source Screen

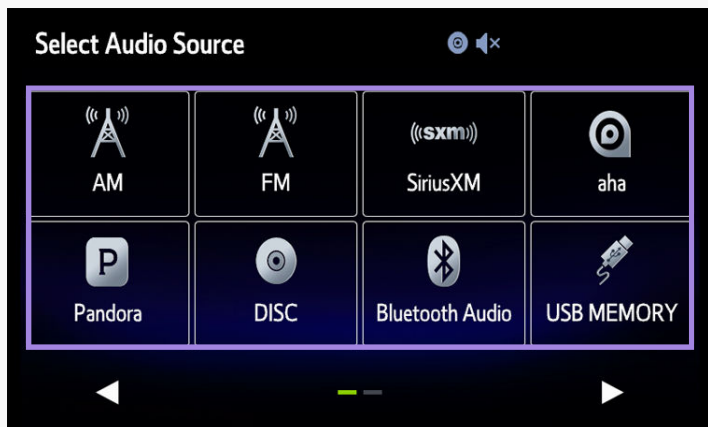

Pandora: Not available for Canadian model

Mix (AM/FM/XM) Preset Stations



- Store up to 36 stations from any of the AM, FM and Sirius XM radios

Station List (FM Only) Screen

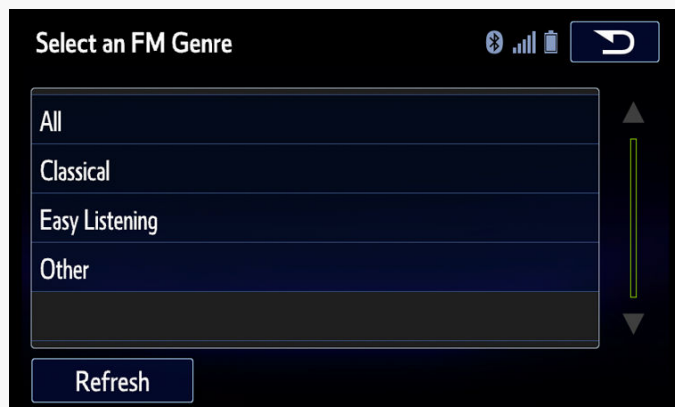

- FM stations are sorted by Genre such as Classic, Jazz, Rock, Country, News, R&B, Sports and Other
- Station list cannot be updated automatically by the GPS signal, but update manually from FM radio screen by pressing the "LIST" button

*Not available for Canadian model

1. Introduction of Gen II Audio/Navigation System

Audio/Visual Functions

Cache Radio Program (AM/FM/HD)

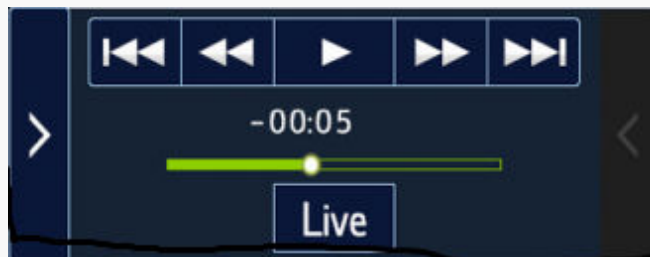

- When the radio broadcast is interrupted by another audio output, such as an incoming phone call or Voice Recognition, the unit will automatically cache the interrupted portion and perform time-shift (20 minutes max) playback when the interruption ends

HD Radio (Artist Experience)

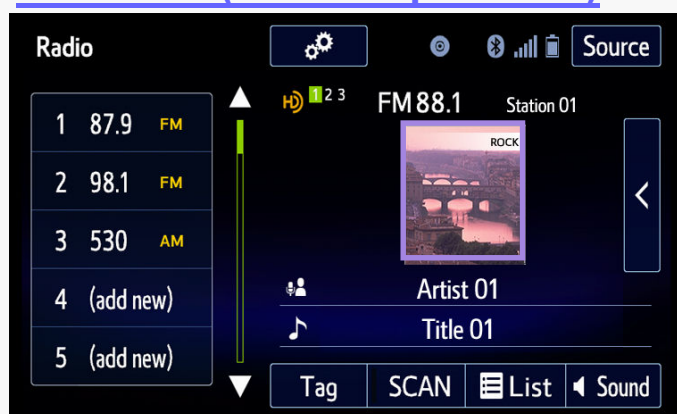

- When available, HD Radio will supply visual information such as Album Art, and Artist Pictures on screen related to the content being played.
- No visual information is displayed when the HD radio is not transmitting the visual data

HD Radio: Not available for Canadian model

USB / Micro SD (Audio/Video/Picture)



- Audio, Video and Image files stored on USB memory and Micro SD card can be played back or viewed
- While driving, video/slideshow will not be played back, but the user will hear the audio portion of the video
- Audio, Video and images files saved in the Map SD card cannot be played and viewed

Micro SD functions: Not available for non-Navigation equipped models

Supported Format & Files

Media Type	Format	Audio Files	Video Files	Image Files
USB Memory	USB 2.0 HS FAT 16/32	MP3/WMA/AAC	WMV/AVI/MPEG4	JPG, JPEG
Micro SD card	micro SD HC Up to 32GB	MP3/WMA/AAC	WMV/AVI/MPEG4	JPG, JPEG

1. Introduction of Gen II Audio/Navigation System

Audio/Visual Functions

Sirius XM Satellite Radio

(Gen 2.0)

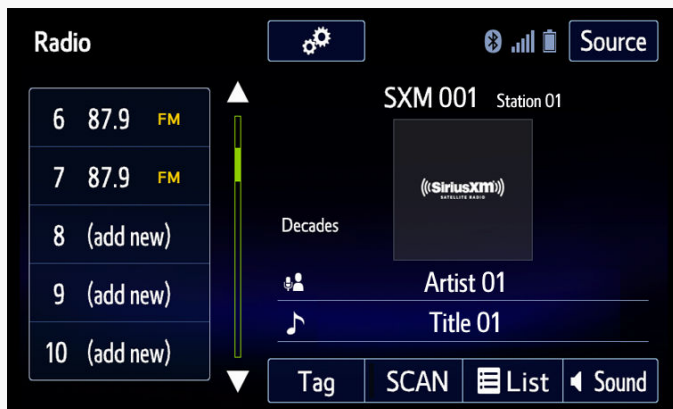

(Gen 2.1)

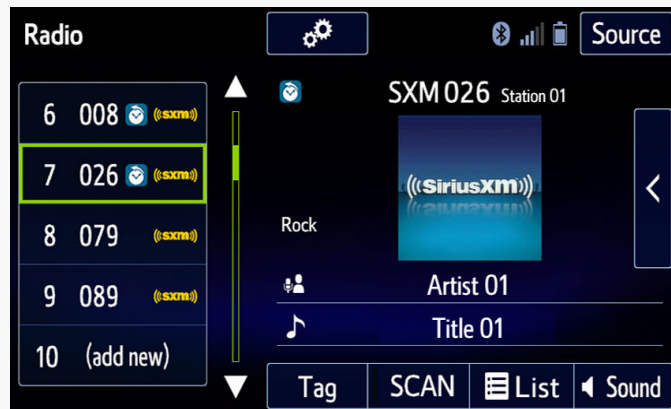

Features	Gen 2.0	Gen 2.1
Tag	Yes	Yes
SCAN	Yes	Yes
List	Yes	Yes
Sound	Yes	Yes
Cache	No	Yes
Featured Favorites	No	Yes
Smart Favorites	No	Yes
Tune Scan	No	Yes
Tune Start	No	Yes

- **Tag:** Tag information in the music broadcasting is preserved in the system and transmits to an iPod
- **SCAN:** Scan channels
- **List:** Display a list of category such as Pop, Rock, Hip-Hop, R&B and so on
- **Sound:** Display sound setting screen
- **Cache:** A radio program can be cached and played back in a time shifted manner. The program that is currently being listened to, and channel programs registered as Smart Favorites can be cached. (Available for Gen 2.1)

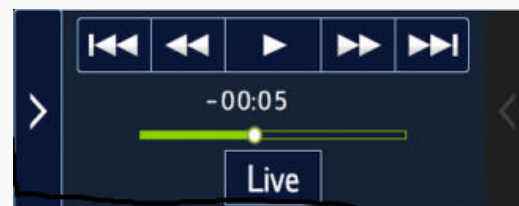

1. Introduction of Gen II Audio/Navigation System

Audio/Visual Functions

- **SXM Featured:** SXM Featured is a collection of channels that are created by the Sirius XM programming team that are updated several times throughout the year. The SXM Featured channels can be found under the SXM Category screen. To use this function, the “**SXM Featured**” should be turned on in the option screen.
(Available for Gen 2.1)

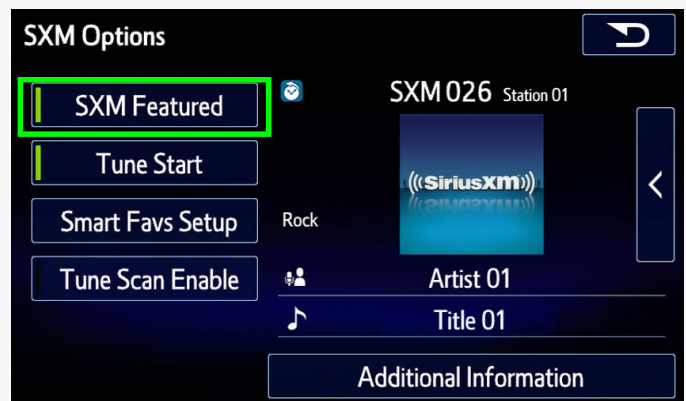

- **Smart Favorites:** Smart Favorites can be set up by the user. They can select up to 5 SXM channels from the preset bank. The Smart Favorite channels will be cached simultaneously from when the SXM signal is first received.
(Available for Gen 2.1)

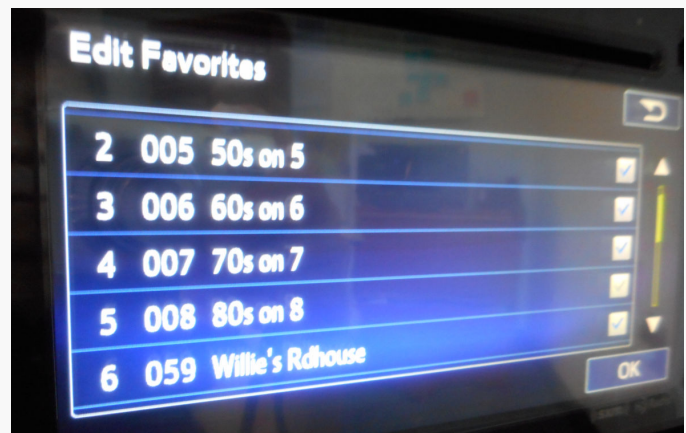
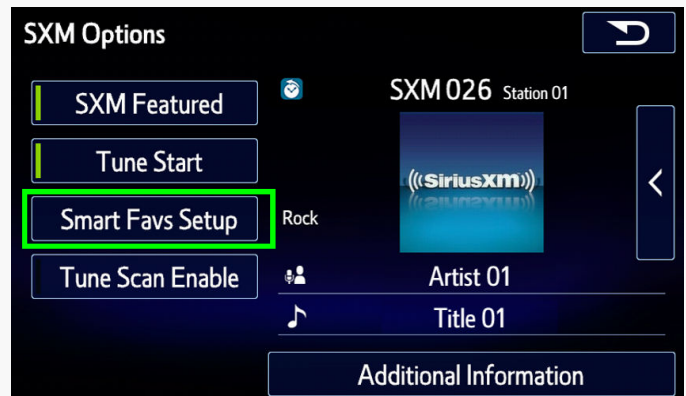

1. Introduction of Gen II Audio/Navigation System

Audio/Visual Functions

Sirius XM Satellite Radio

- **Tune Scan:** Tune Scan is a function to play the first 10 seconds of Smart Favorite channels. It is necessary to turn on Tune Scan at the option screen to use this function. Some Channels may not be able to Tune Scan due to station content or the way it is broadcast.
(Available for Gen 2.1)
- **Tune Start:** Tune Start begins playing the current program from the beginning when tuning to a channel registered in Smart Favorites, allowing you to enjoy the complete program. It is necessary to turn on Tune Start at the option screen to use this function.
(Available for Gen 2.1)

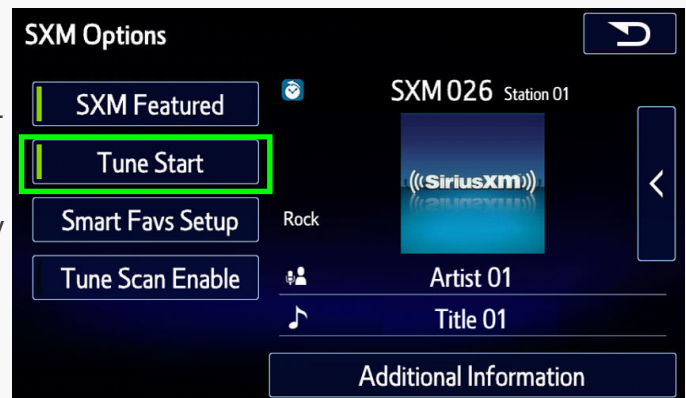

1. Introduction of Gen II Audio/Navigation System

Audio/Visual Functions

Siri (Siri Eyes Free)

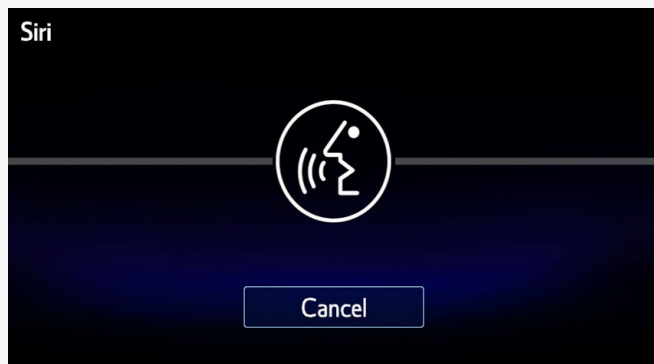

(Available for Gen 2.1)

- An extension of Apple's Siri functionality for enabling voice control of an iOS mobile device (iPhone, iPod touch)
- Device is connected with the head unit via Bluetooth connection
- Device communicates with internet via wireless network (Wifi, 3G, 4G, 4G LTE)
- Press and hold the "Talk Switch" on the steering switch to start and then speak when the beep sound is heard

Supported Models	Supported iOS Version
iPhone 4S, 5, iPod Touch (5th generation) or later	iOS 6 or later

2. Troubleshooting

System Diagram - AVN

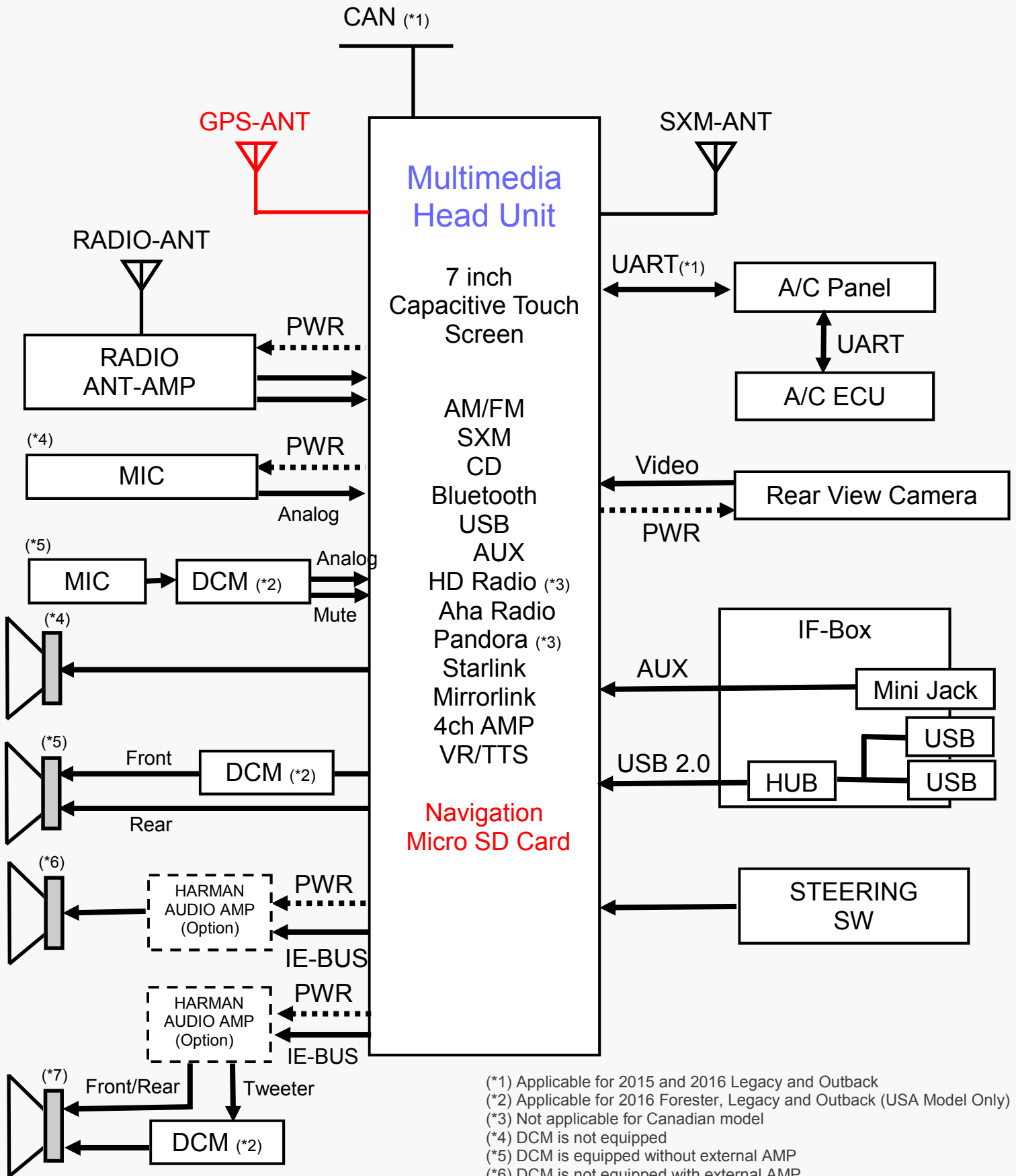

(*1) Applicable for 2015 and 2016 Legacy and Outback
 (*2) Applicable for 2016 Forester, Legacy and Outback (USA Model Only)
 (*3) Not applicable for Canadian model
 (*4) DCM is not equipped
 (*5) DCM is equipped without external AMP
 (*6) DCM is not equipped with external AMP
 (*7) DCM is equipped with external AMP

2. Troubleshooting

System Diagram - DA (Display Audio)

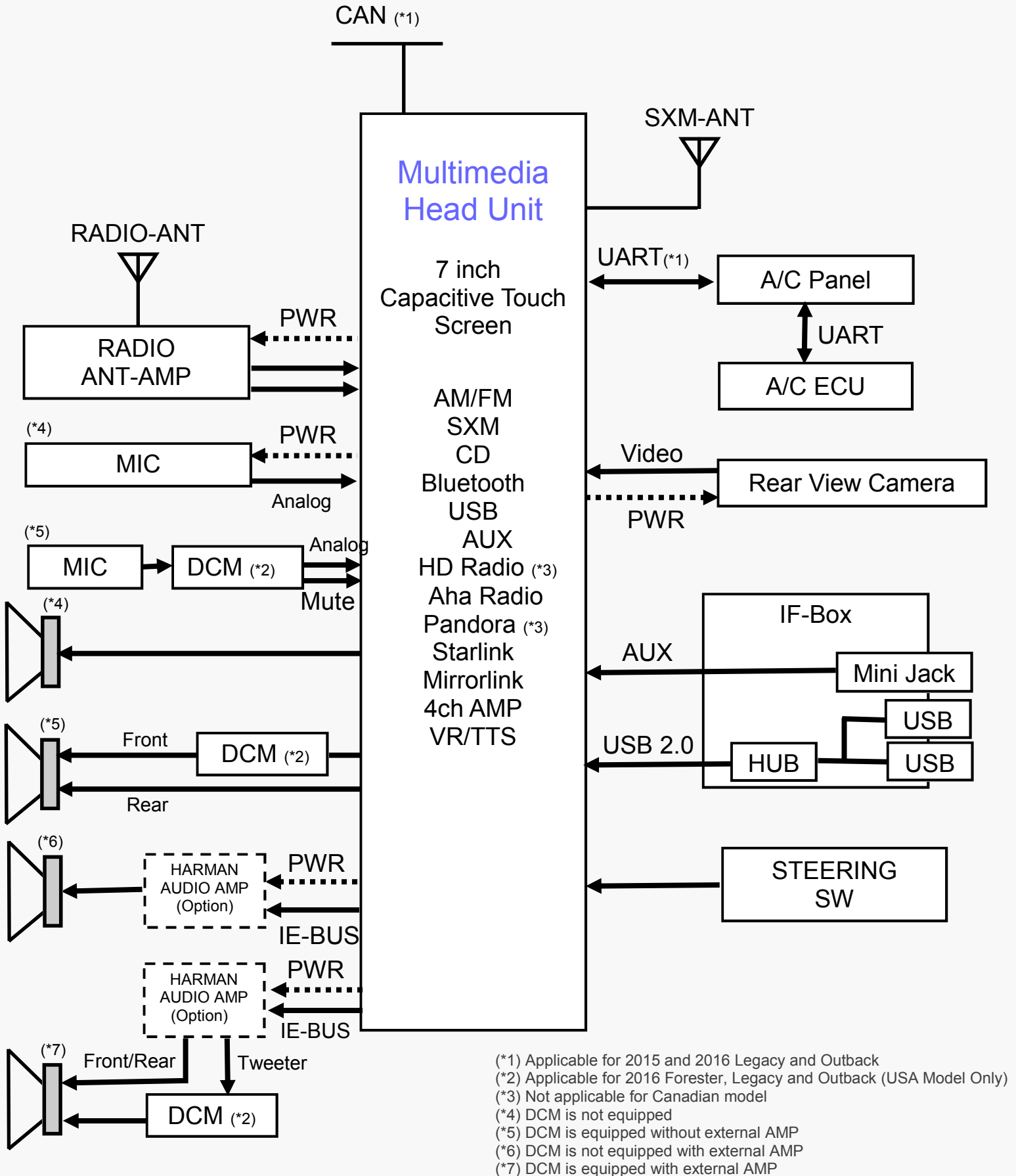

2. Troubleshooting

Connections and Pins

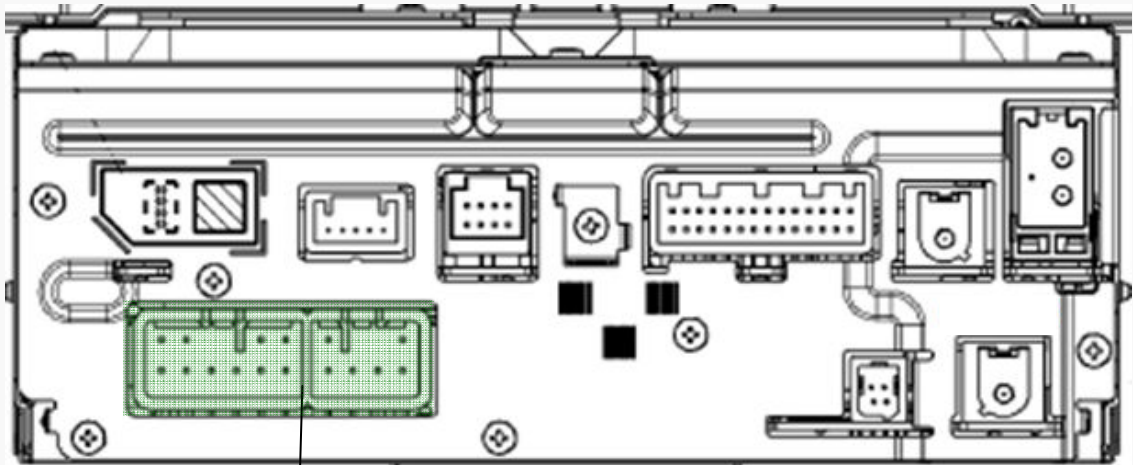

Connector A

Connector A (POWER INPUT/ SPEAKER OUTPUT)	#	Internal AMP	Harman AMP	Description	
	1	FR+	FR+	OUT	Audio signal (Front Right)
	2	FL+	FL+	OUT	Audio signal (Front Left)
	3	ACC	ACC	IN	ACC power supply
	4	BU+B	BU+B	IN	Back-up power supply
	5	FR-	FR-	OUT	Audio signal (Front Right)
	6	FL-	FL-	OUT	Audio signal (Front Left)
	7	GND	GND	GND	Ground
	8	ANT+	ANT+	OUT	Antenna amplifier power supply (12V)
	9	N.C.	N.C.		Not Connected
	10	ILL+	ILL+	IN	Illumination signal (12V)
	11	RR+	N.C.	OUT	Audio signal (Rear Right) / Not Connected
	12	RL+	INT+	OUT	Audio signal (Rear Left) / Interface Box
	13	RR-	N.C.	OUT	Audio signal (Rear Right) / Not Connected
	14	N.C.	SLD2	GND	Not Connected / Ground
	15	ILL-	ILL-	IN	Illumination signal
	16	RL-	INT-	OUT	Audio signal (Rear Left) / Interface Box

2. Troubleshooting

Connections and Pins

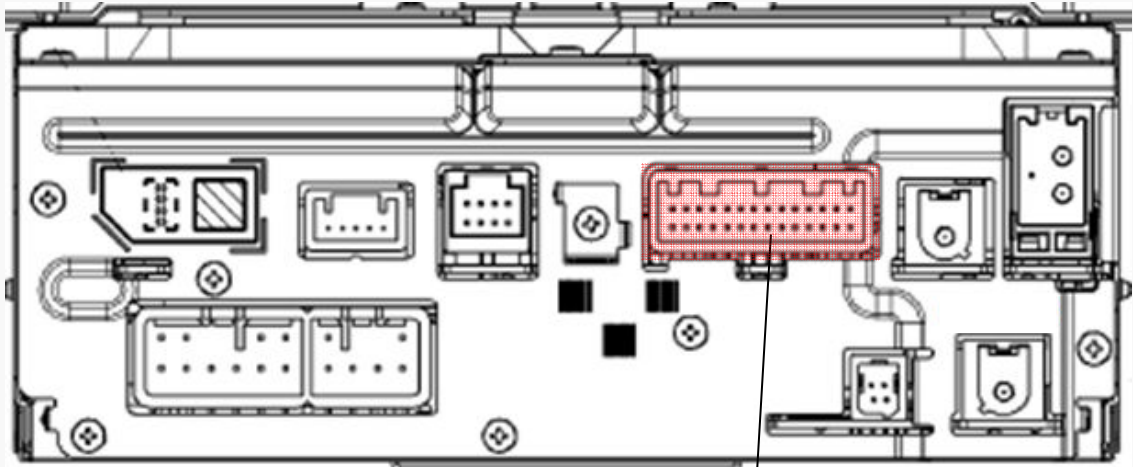

Connector B

Connector B
(Steering Wheel SW,
MIC, etc)

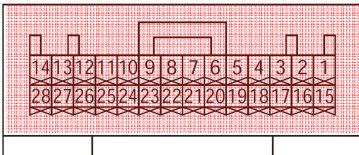

#	Internal AMP	Harman AMP	Descriptions	
1	IGN *	IGN*	IN	Ignition power supply
2	REV	REV	IN	Reverse signal (12V)
3	BRIGHT	BRIGHT		
4	MACC	MACC	OUT	Mic power supply (5V)
5	MIC+	MIC+	IN	Mic signal
6	MIC—DET	MIC—DET	IN	Microphone Detection
7	N.C.	TX+	IN/OUT	Not Connected / Communication+
8	N.C.	TX-	IN/OUT	Not Connected / Communication -
9	CANH *	CANH*	IN/OUT	Communication+
10	CANL *	CANL*	IN/OUT	Communication-
11	AC-UART+ *	AC-UART+*	IN/OUT	Communication+
12	AC-UART- *	AC-UART-*	IN/OUT	Communication-
13	N.C.	N.C.		Not Connected
14	SHIELD-GND(AUX)*	SHIELD-GND(AUX)*	GND	Ground
15	PKB	PKB	IN	Parking brake signal
16	N.C.	MUTE	GND	Not Connected / Mute
17	SPD	SPD	IN	Vehicle speed signal
18	SHIELD-GND(MIC)*	SHIELD-GND(MIC)*	GND	Ground
19	MIC-	MIC-	GND	Ground
20	N.C.	N.C.		Not Connected
21	SW1	SW1	IN	Mic sw signal
22	SW2	SW2	IN	Mic sw signal
23	SWG	SWG	GND	Ground
24	N.C.	N.C.		Not Connected
25	AUX-DET	AUX-DET		
26	AUX-R+	AUX-R+		
27	AUX-LR-	AUX-LR-		
28	AUX-L+	AUX-L+		

* N.C. for 2015 Impreza, XV Crosstrek, 2016 WRX and Forester

2. Troubleshooting

Connections and Pins

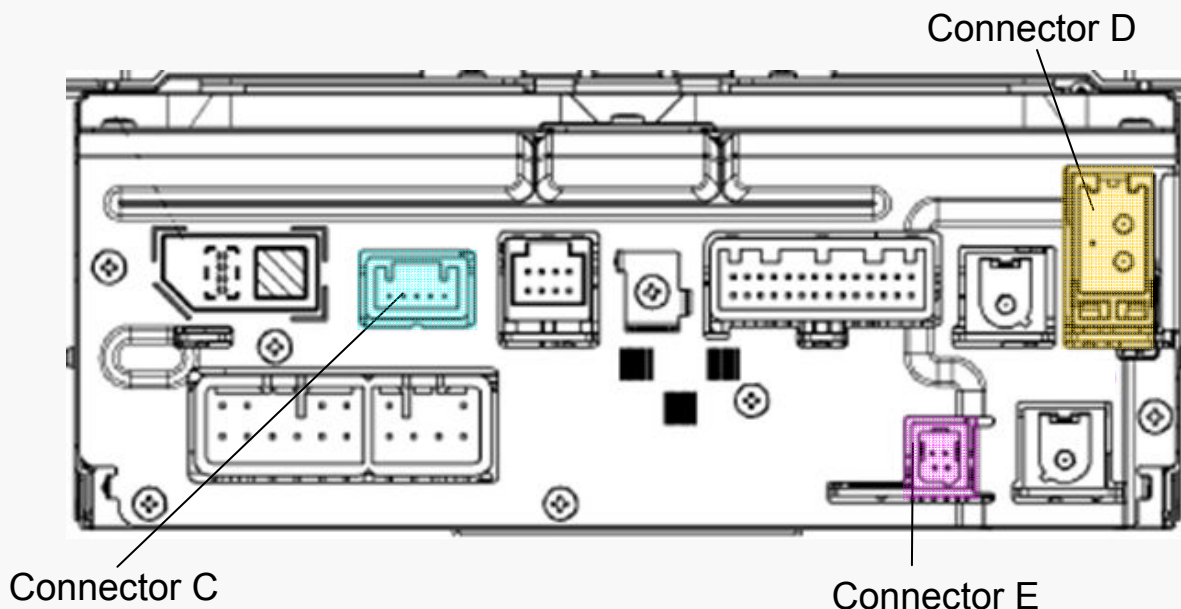

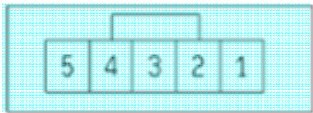
Connector C (Rear Camera)	#	Pin	Descriptions	
	1	CGND	GND	Camera Ground
	2	CB+	OUT	Back-eye camera power supply (6V)
	3	CV+	IN	Video
	4	CV-	GND	Ground
	5	N.C.		Not Connected

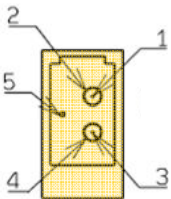
Connector D (Radio Antenna)	#	Pin	Descriptions	
	1	SUB-ANT*	IN	Radio Signal (Sub)
	2	SUB-ANT-DET*	IN	Ground
	3	MAIN-ANT	IN	Radio Signal (Main)
	4	GND	GMD	Ground
	5	N.C.		Not Connected

* N.C. for 2015 Impreza, XV Crosstrek, 2016 WRX and Forester

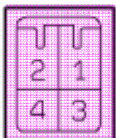
Connector E (USB)	#	Pin	Descriptions	
	1	N.C.		Not Connected
	2	N.C.		Not Connected
	3	D+	IN	Data
	4	D-	IN	Data

2. Troubleshooting

Connections and Pins

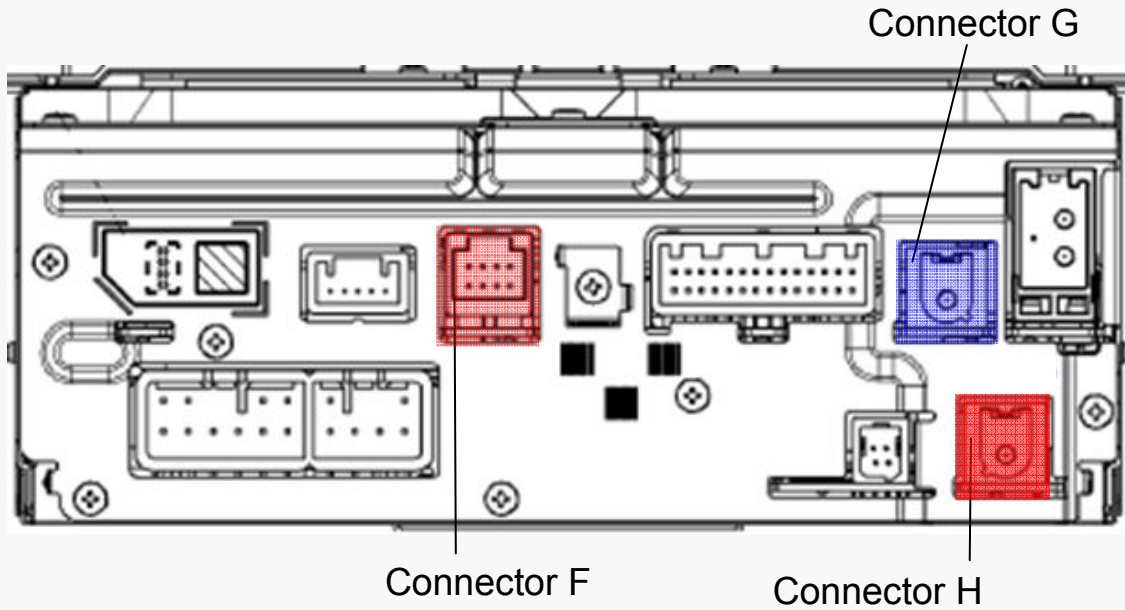

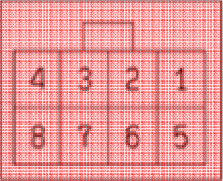
Connector F (DCM)* 	#	Pin	Descriptions	
	1	N.C.		Not Connected
	2	N.C.		Not Connected
	3	N.C.		Not Connected
	4	N.C.		Not Connected
	5	N.C.		Not Connected
	6	N.C.		Not Connected
	7	N.C.		Not Connected
	8	MUTE	IN	DCM

*Applicable for 2016 Forester, Legacy and Outback (USA Model Only)

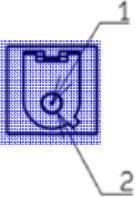
Connector G (XM Antenna) 	#	Pin	Descriptions	
	1	ANT	IN	XM Radio Signal
2	GND	GND	Ground	

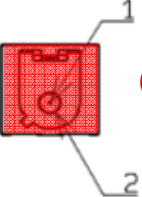
Connector H (GPS Antenna)  (AVN Only)	#	Pin	Descriptions	
	1	ANT	IN	GPS Signal
2	GND	GND	Ground	

2. Troubleshooting

On-Board Diagnostic Mode

1. Outline

On-Board Diagnostics can check the connectivity of devices, the vehicle signals, the radio reception and rear view camera setting.

2. How to enter On-Board Diagnostic mode

2-1. Enter the Diagnostic mode

Procedure:

- 1) Turn the ignition switch to ACC.
- 2) Press the button (b) twice with the button (a) pressed.

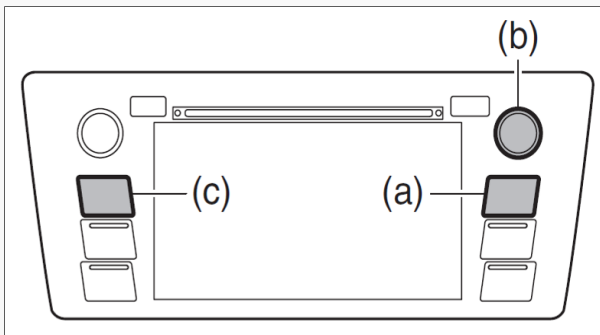

- 3) “Line Diag” screen is displayed.
- 4) Check the connection status with the “Connectivity Check” in the “Line Diag” screen.

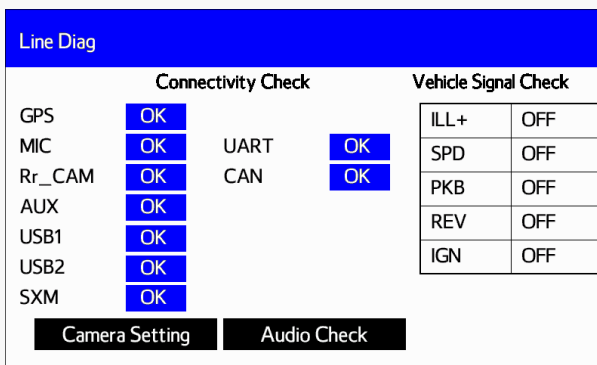

Note:

1. “UART” and “CAN” are not shown for 86271FJ630/730 and 86201FJ660/760
2. “GPS” will indicate “NG” on non-Navigation equipped Infotainment systems

2-2. Exit the Diagnostic mode

Pressing the button (c) for 3 seconds or more, or turning the ignition switch from the ACC to OFF position can exit the diagnostic mode.

2. Troubleshooting

On-Board Diagnostic Mode

3. Display Layout and Explanation

3-1. Top Display Layout

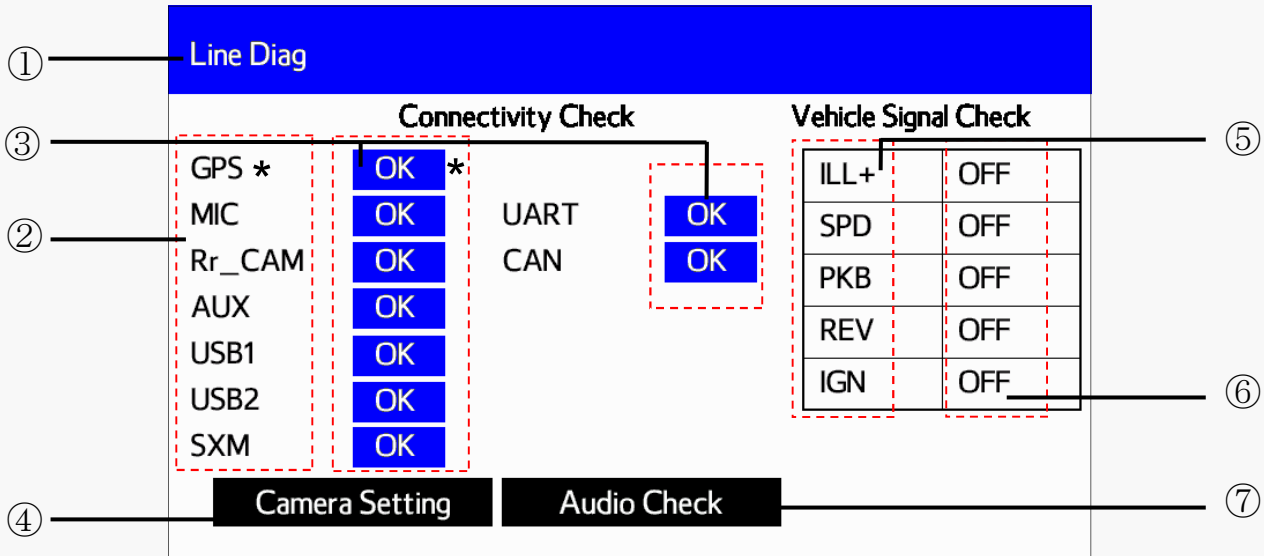

Note:

1. "UART" and "CAN" are not shown for 86271FJ630/730 and 86201FJ660/760
2. "GPS" will indicate "NG" on non-Navigation equipped Infotainment systems

No	Explanation
①	Main title [White] after check [Black] under check
②	Connected Devices
③	Results of Connectivity Check

No	Explanation
④	Enter Camera Setting
⑤	Vehicle Signal
⑥	Vehicle Signal Check Results
⑦	Enter Audio Check

3-2. Enter "Camera Setting"

If "Camera Setting" button is touched, the screen changes to "Camera Setting" mode.

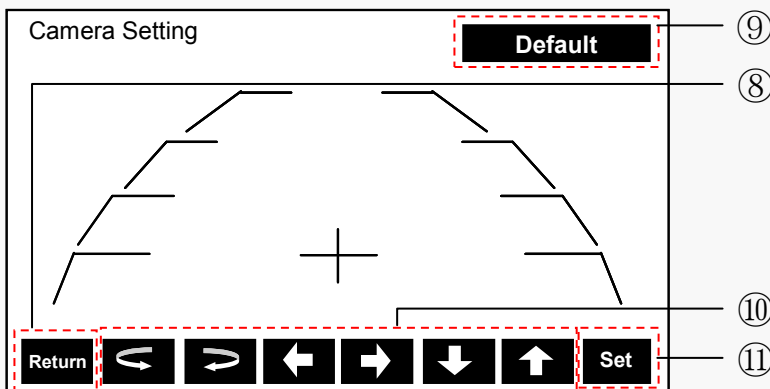

No	Explanation
⑧	Return to Previous Screen
⑨	Initialization of Marker Line Adjustment
⑩	Marker Line Adjustment
⑪	Finalization of Marker Line Adjustment

Note:

For a detailed procedure to adjust the camera settings, refer to STIS. Please select the Service Manual and refer to the Navigation System under the Entertainment Section (ET)

2. Troubleshooting

On-Board Diagnostic Mode

3-3. Enter "Audio Check"

If the "Audio Check" button is touched, the screen changes to "Audio Check" mode.

No	Explanation
⑬	Return to Previous Screen
⑭	Selection of Radio Band (AM/FM)
⑮	Change Radio Frequency
⑯	Radio Frequency
⑰	Speaker Check ["OFF", Black] after check ["ON", Light Blue] under check

4. How to check STARLINK Connectivity ID Number and Software Version Information

4-1. Enter the Service Menu

Procedure:

- 1) Turn the ignition switch to ACC
- 2) Press the button (b) 5 times with the button (c) pressed.

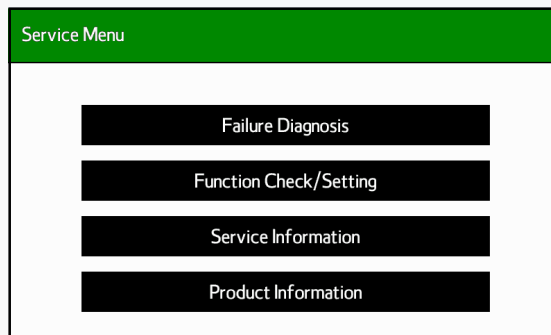
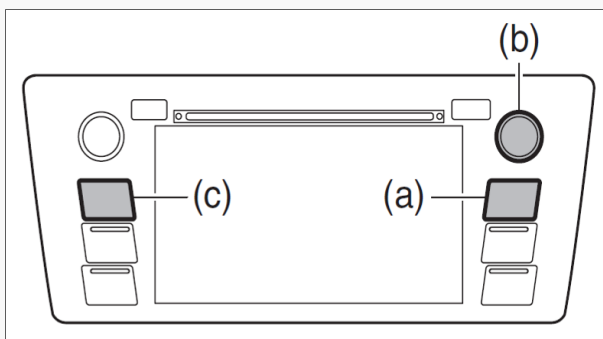

- 3) "Service Menu" is displayed
STARLINK Connectivity ID Number:
 Touch "Product Information" to display the Connectivity ID (16 digits)



- Software Version Information:**
1. Touch "Service Information"
 2. Touch "Version Information"
 3. Touch "Push" next to AVN or DA

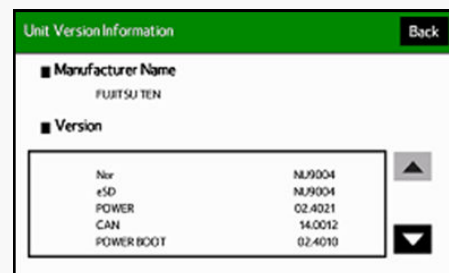

4-2. Exit the Service Menu

Pressing the button (c) for 3 seconds or more, or turning the ignition switch from the ACC to OFF position can exit the diagnostic mode.

2. Troubleshooting

NO POWER

Condition: No Audio, No Display, No Illumination in all modes.

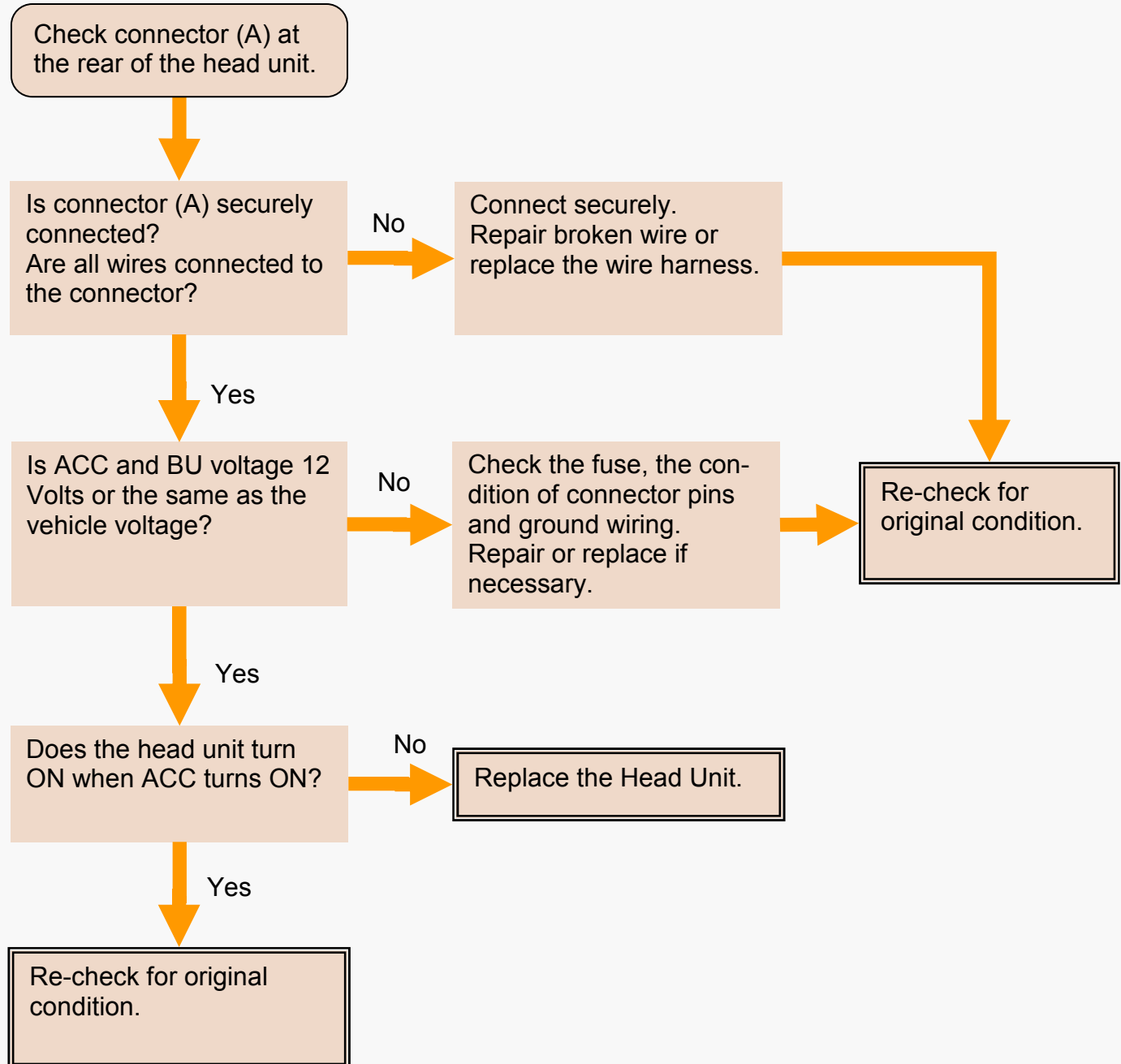

2. Troubleshooting

NO SOUND (All modes) with Internal Amp

Condition: Absolutely no sound on all modes

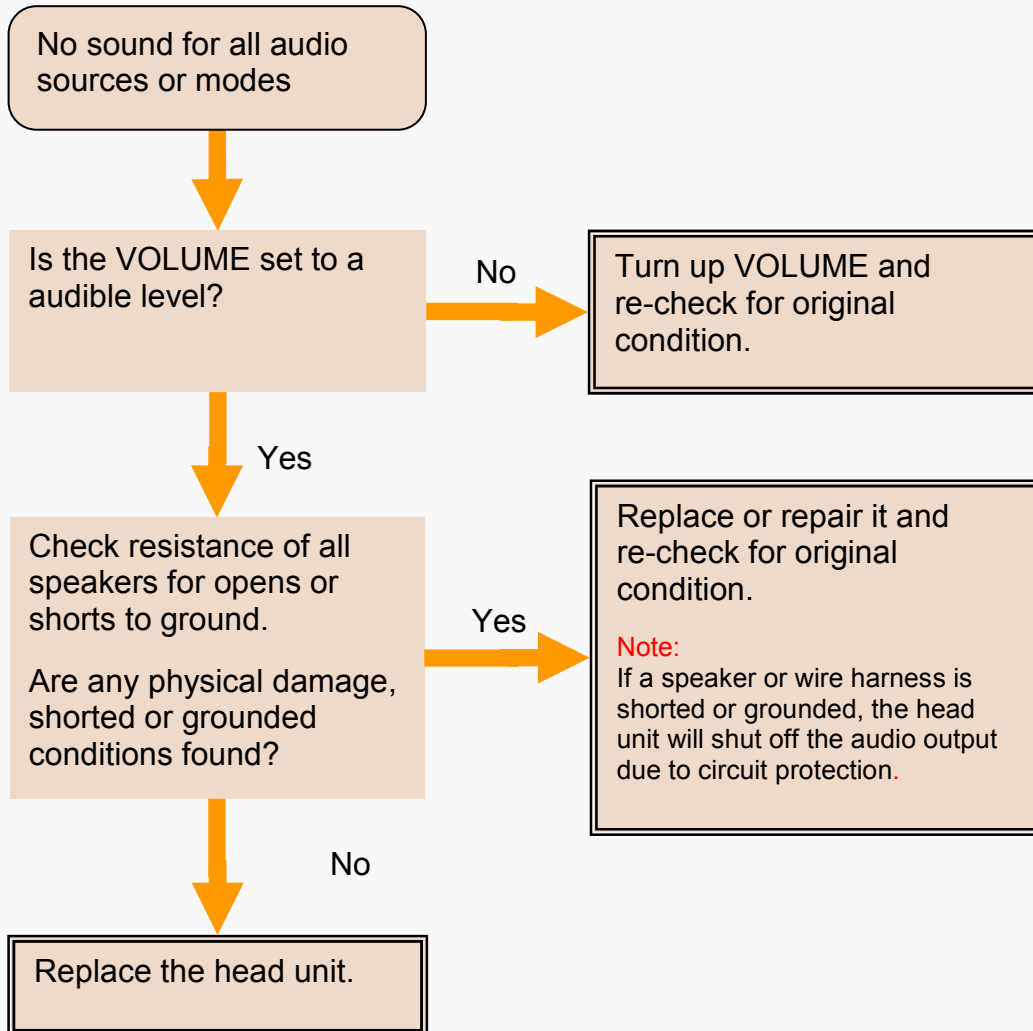

2. Troubleshooting

NO SOUND (All modes) With External Amp

Condition: Absolutely no sound on all modes.

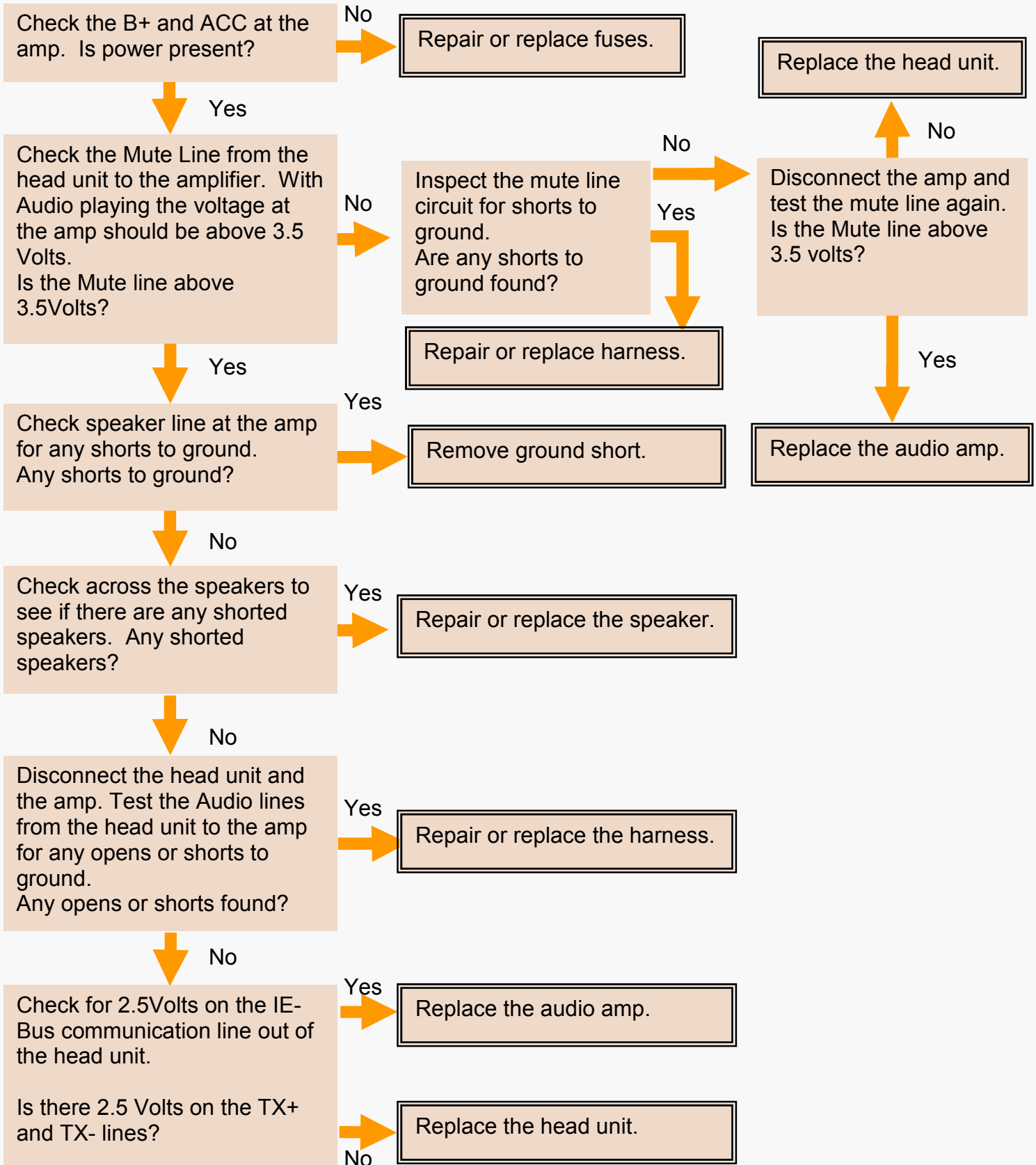

2. Troubleshooting

NO SOUND (AM/FM)

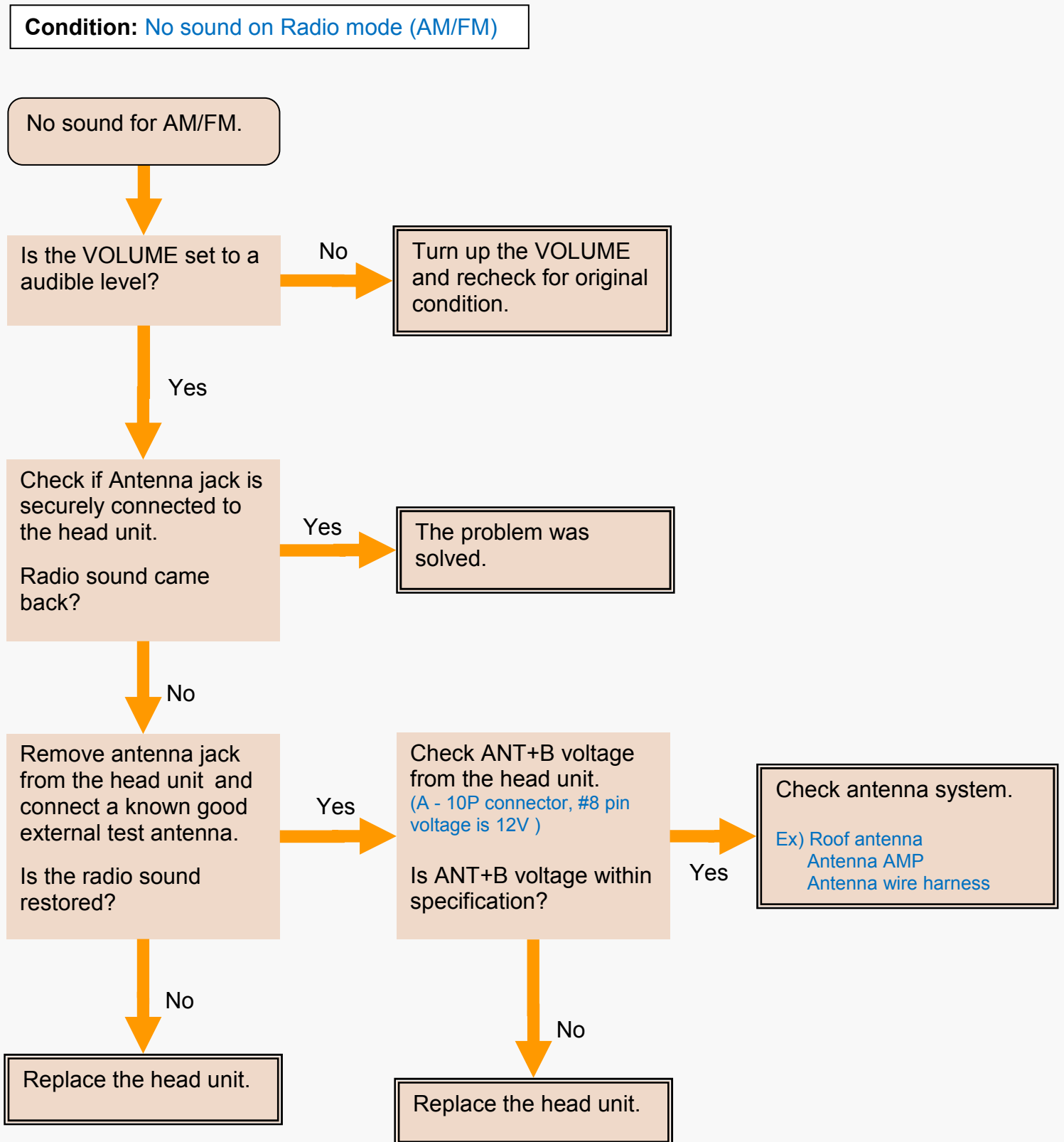

2. Troubleshooting

VOLUME FADES UP AND DOWN (FM/AM HD* RADIO)

Condition: A noticeable drop in audio level is heard when listening to AM/FM radio.

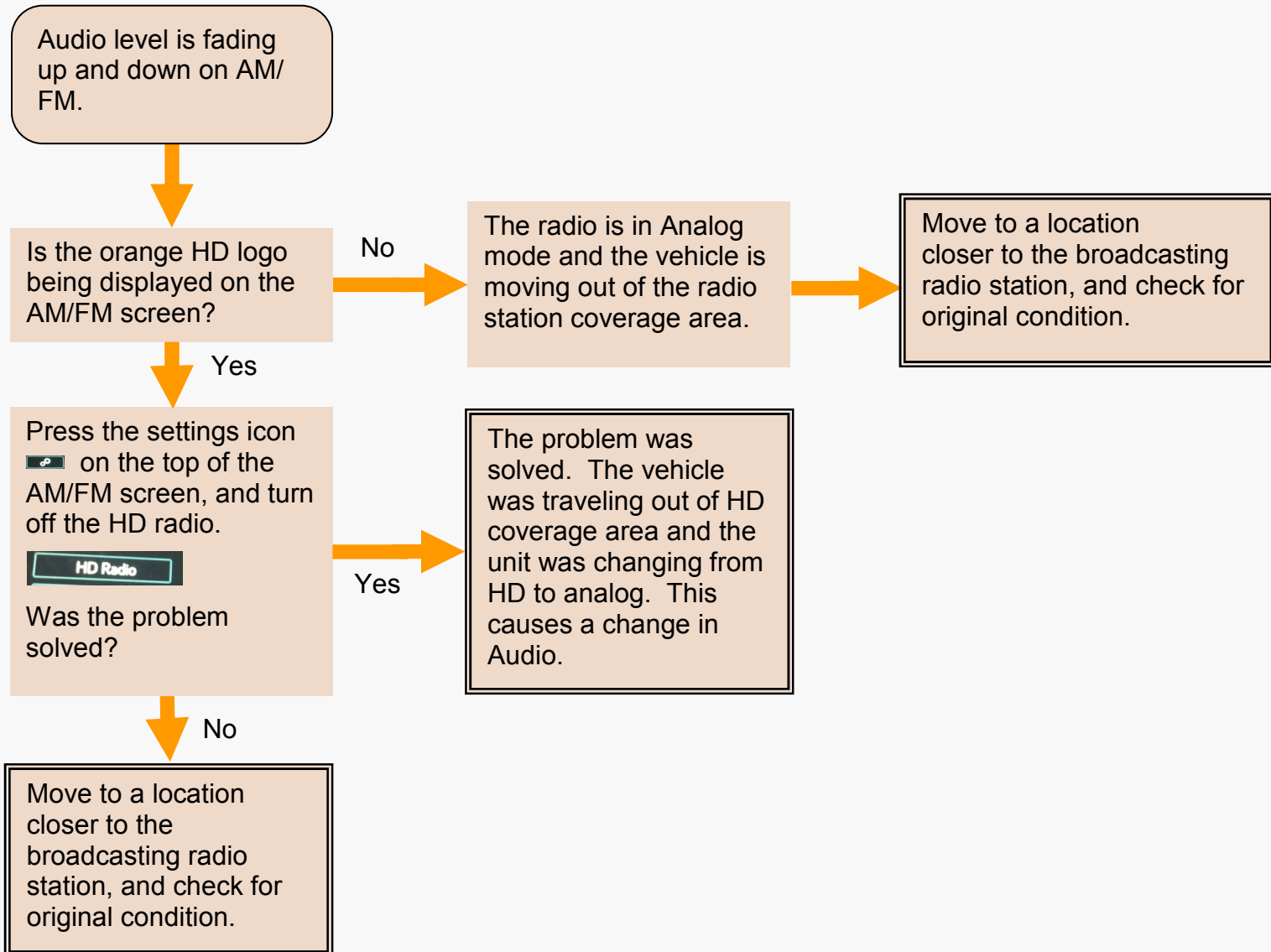

*Not available for Canadian model

2. Troubleshooting

NO SOUND (SAT RADIO)

Condition: No sound on SAT radio

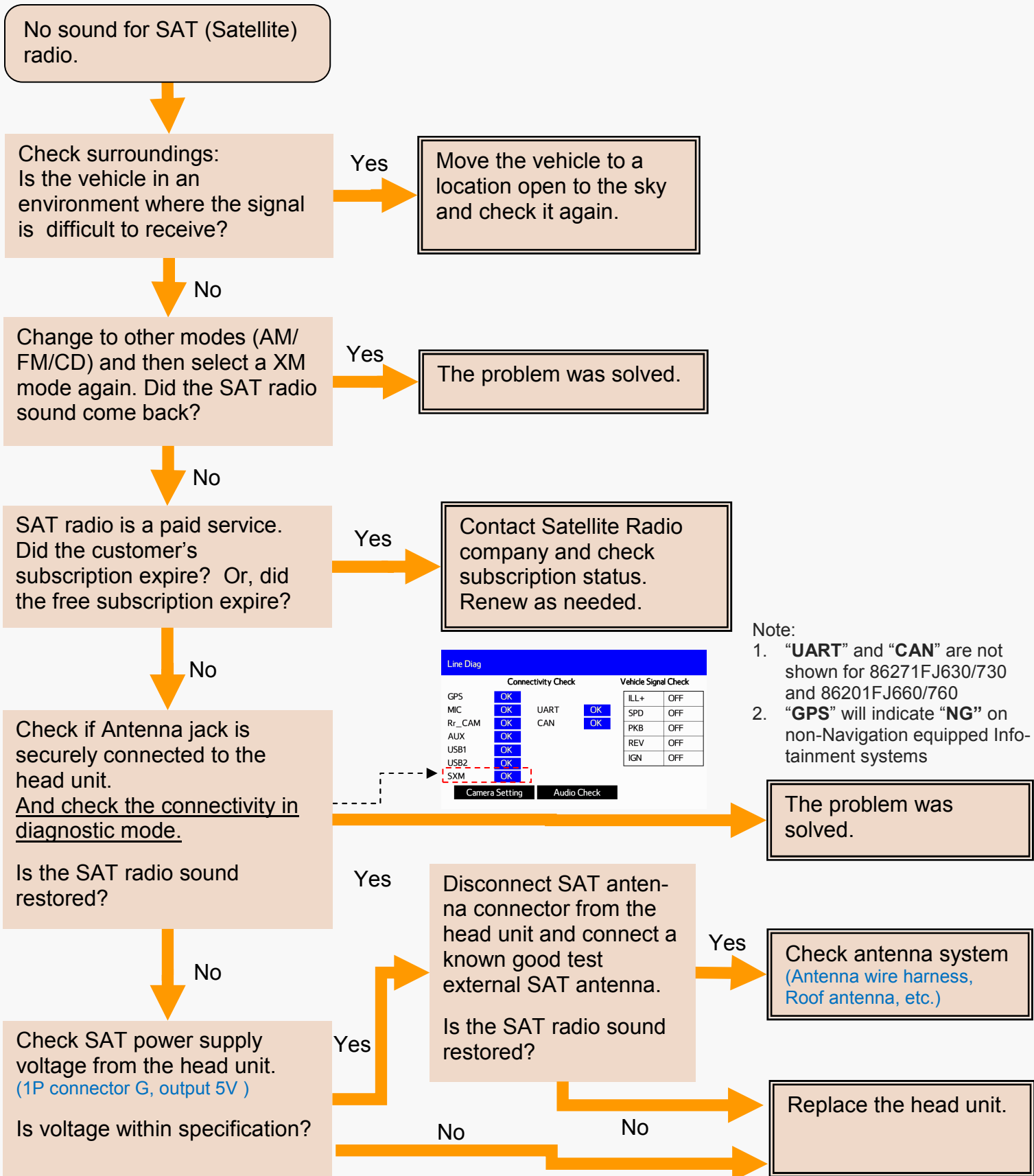

Note:
 1. "UART" and "CAN" are not shown for 86271FJ630/730 and 86201FJ660/760
 2. "GPS" will indicate "NG" on non-Navigation equipped Infotainment systems

2. Troubleshooting

NO SOUND (USB)

Note:

1. "UART" and "CAN" are not shown for 86271FJ630/730 and 86201FJ660/760
2. "GPS" will indicate "NG" on non-Navigation equipped Infotainment systems

Line Diag		Connectivity Check		Vehicle Signal Check	
GPS	OK	UART	OK	ILL+	OFF
MIC	OK	CAN	OK	SPD	OFF
Rr_CAM	OK			PKB	OFF
AUX	OK			REV	OFF
USB1	OK			IGN	OFF
USB2	OK				
SXM	OK				

Camera Setting Audio Check

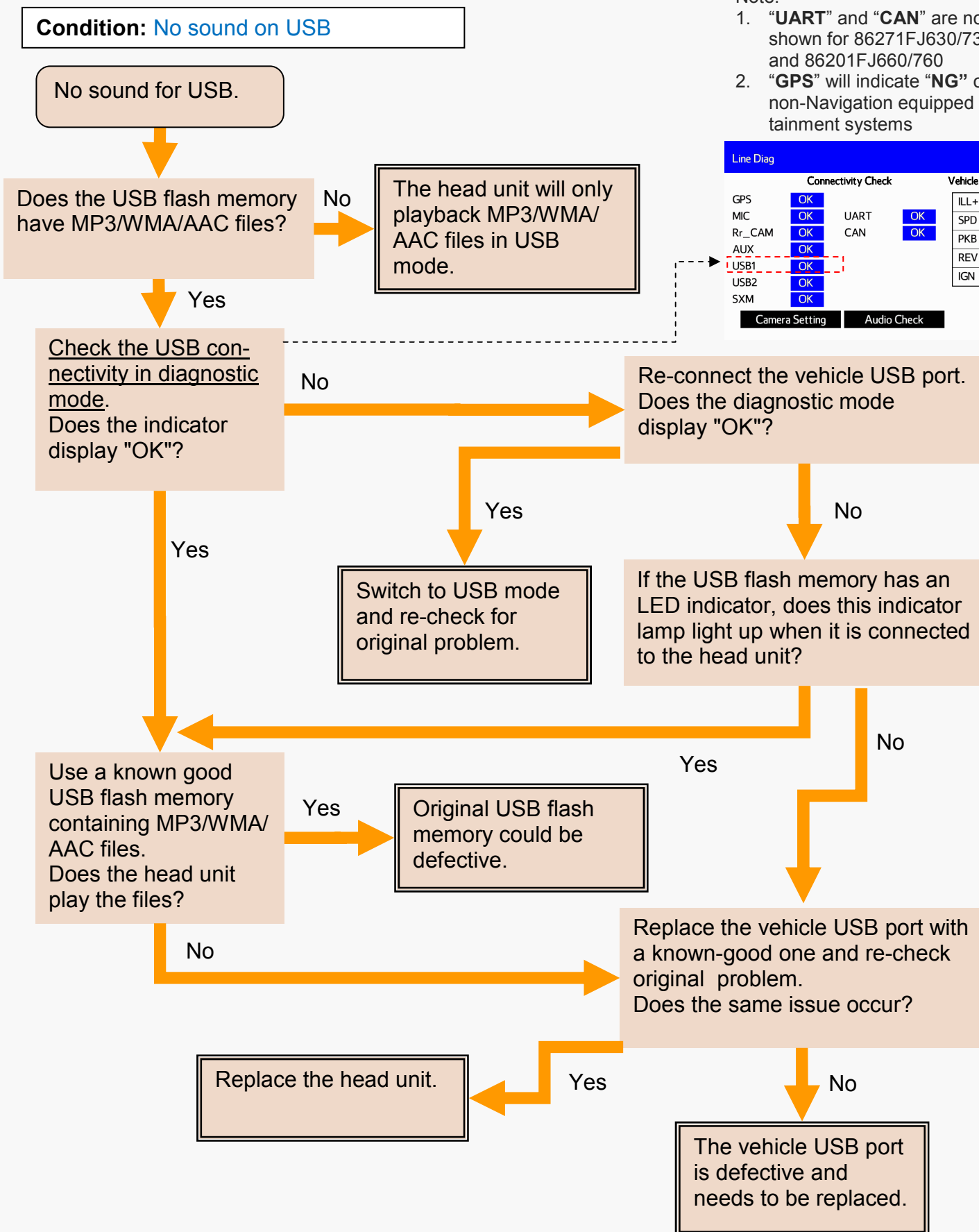

2. Troubleshooting

NO SOUND (CD)

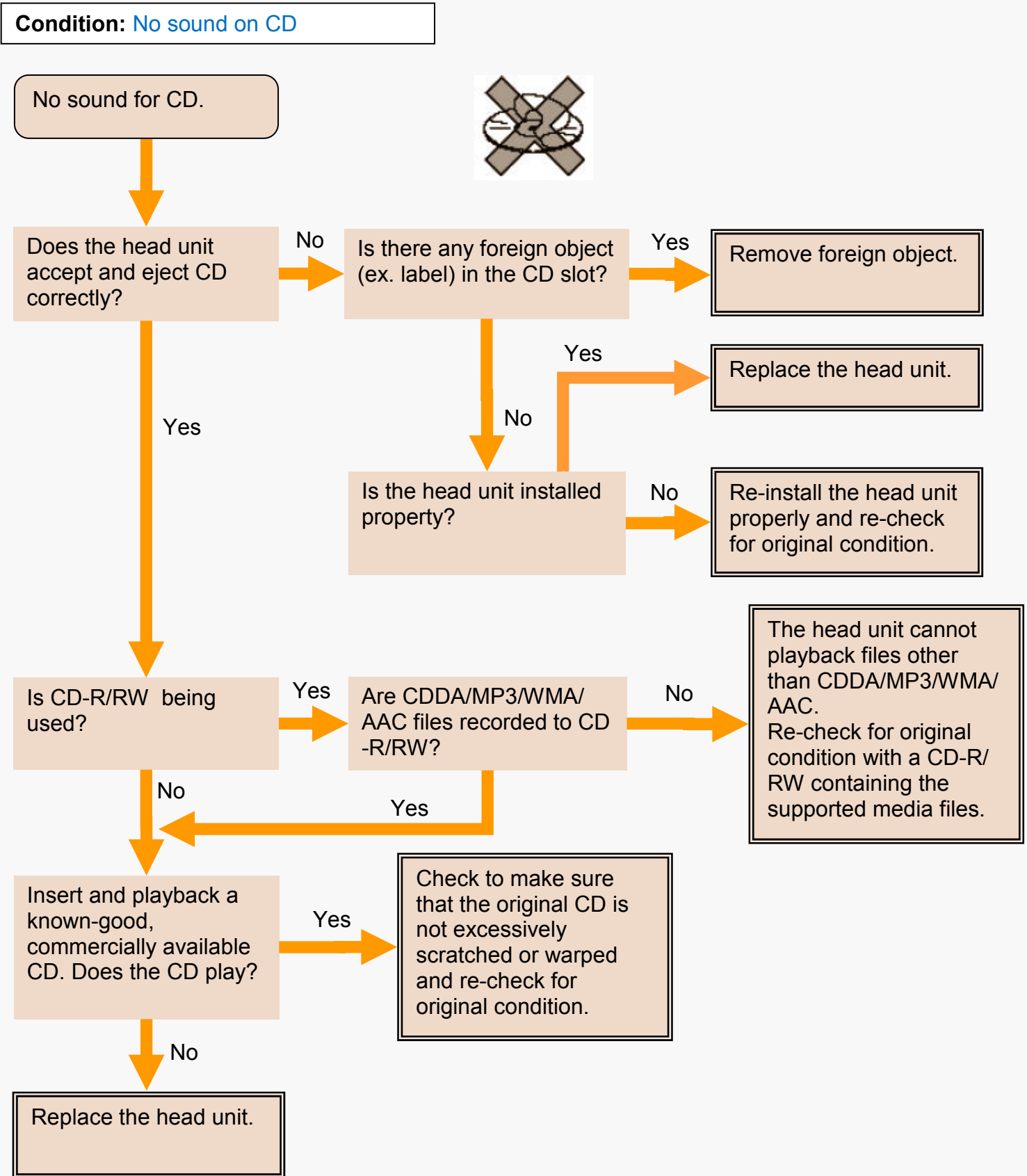

2. Troubleshooting

NO SOUND (AUX)

Condition: No sound on AUX

Note:

1. "UART" and "CAN" are not shown for 86271FJ630/730 and 86201FJ660/760
2. "GPS" will indicate "NG" on non-Navigation equipped Infotainment systems

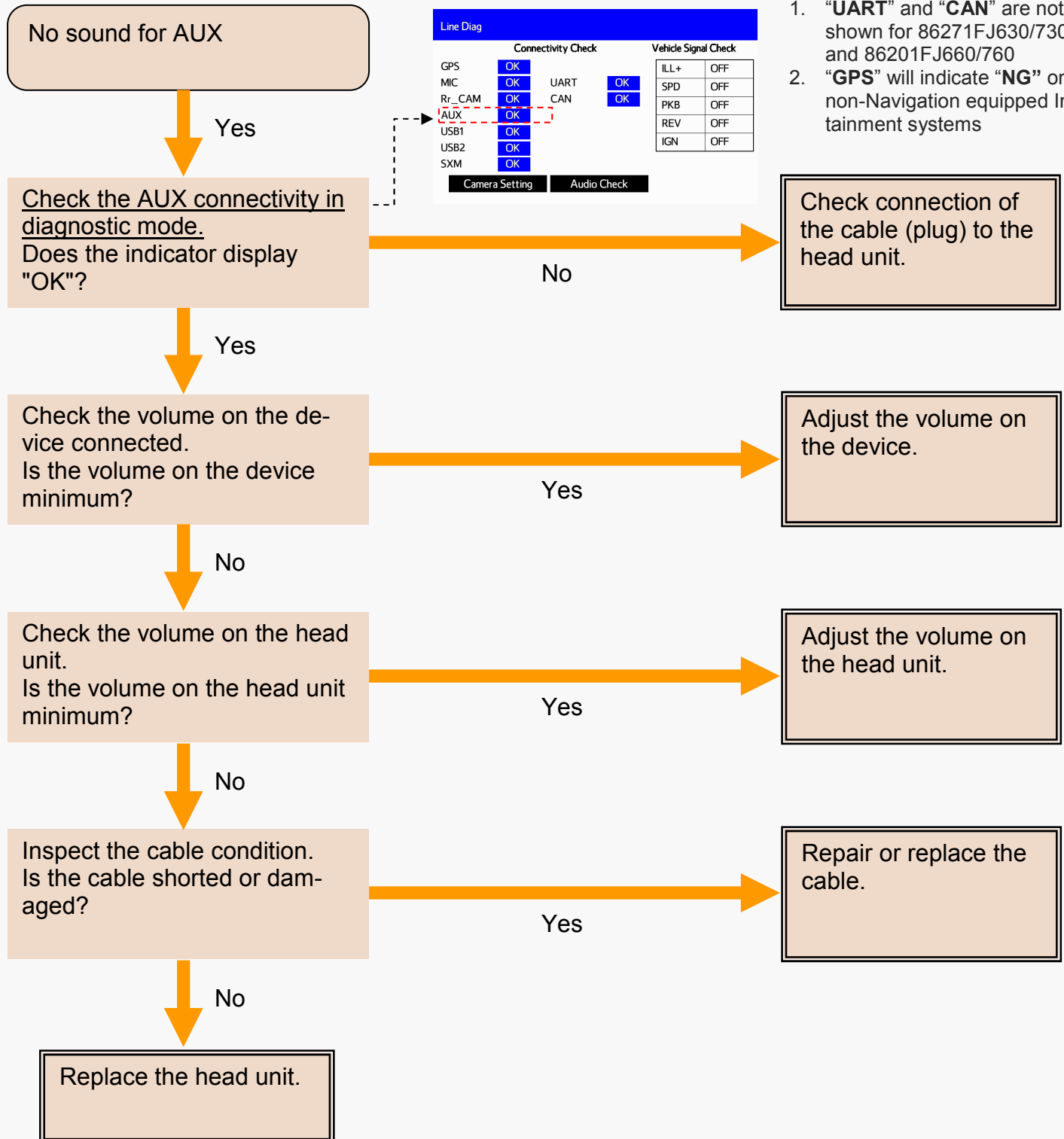

2. Troubleshooting

NO SOUND (iPod)

Condition: No sound on iPod

Note:

1. "UART" and "CAN" are not shown for 86271FJ630/730 and 86201FJ660/760
2. "GPS" will indicate "NG" on non-Navigation equipped Infotainment systems

Line Diag		Connectivity Check		Vehicle Signal Check	
GPS	OK	UART	OK	ILL+	OFF
MIC	OK	CAN	OK	SPD	OFF
Rr_CAM	OK			PKB	OFF
AUX	OK			REV	OFF
USB1	OK			IGN	OFF
USB2	OK				
SXM	OK				

Camera Setting Audio Check

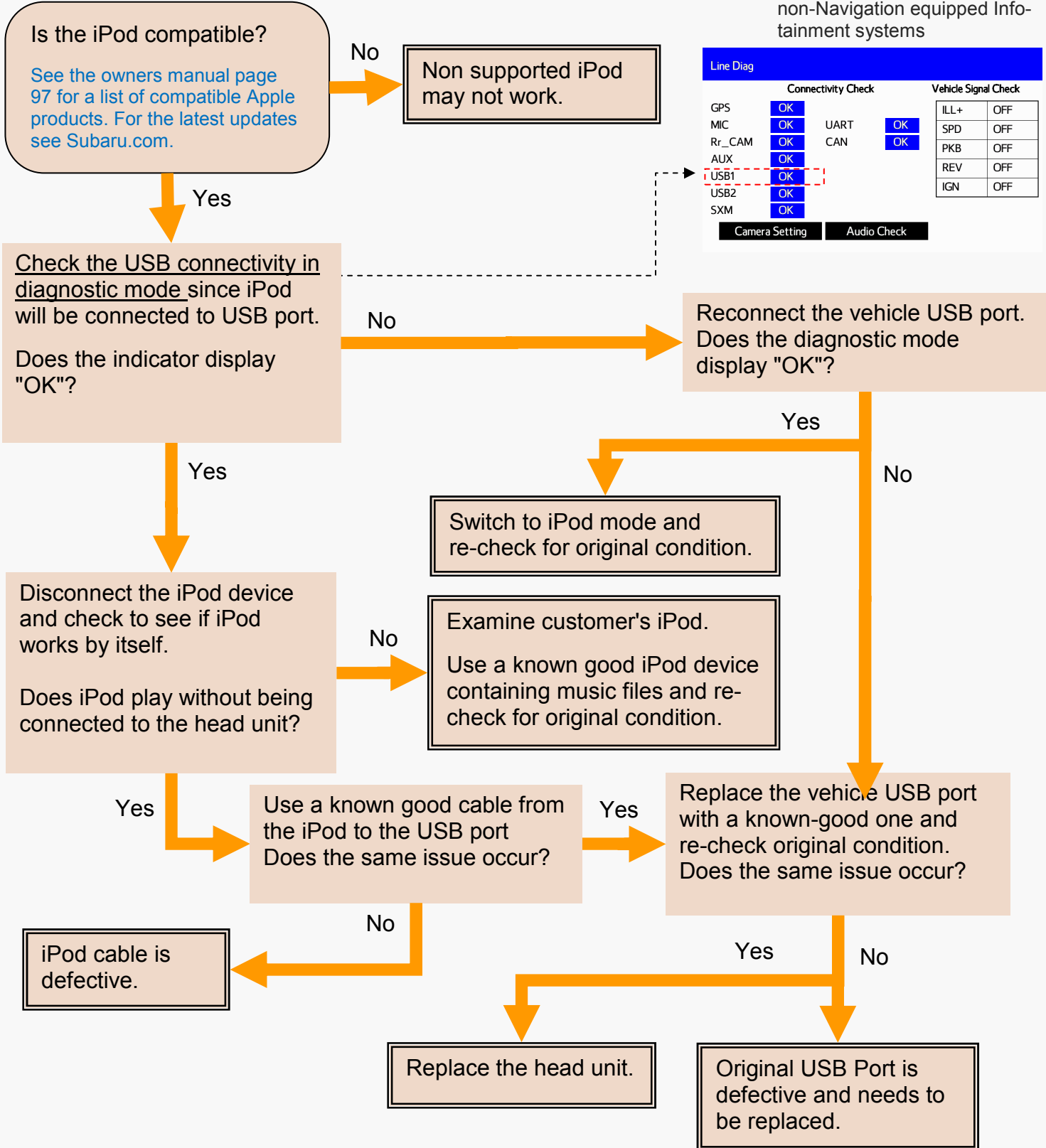

2. Troubleshooting

CD SKIP

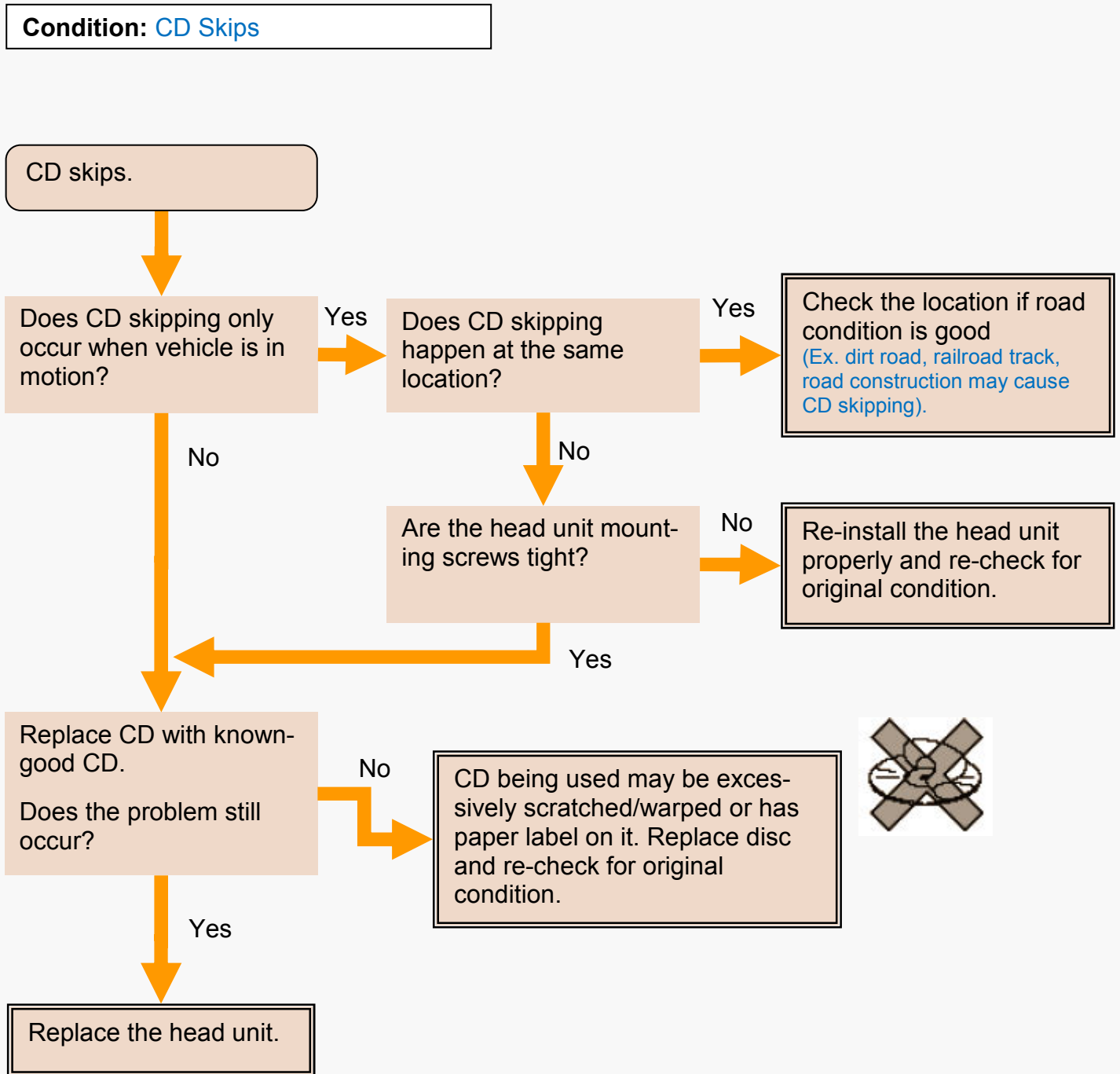

2. Troubleshooting

CD WON'T PLAY CORRECTLY

Condition: Won't read CD, abnormal playback, makes noise when playing CD

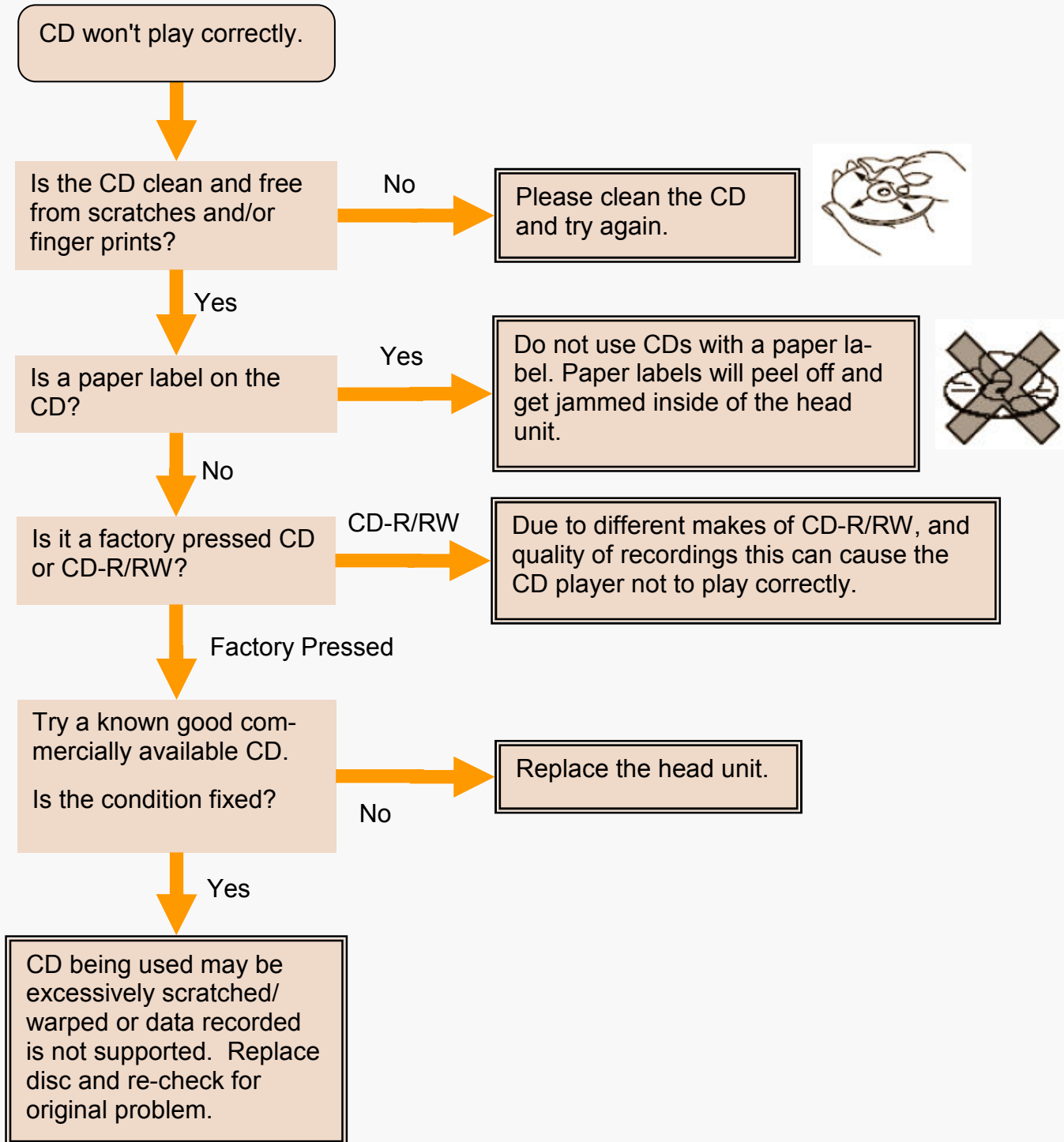

2. Troubleshooting

SOUND IS POOR OR NOISY

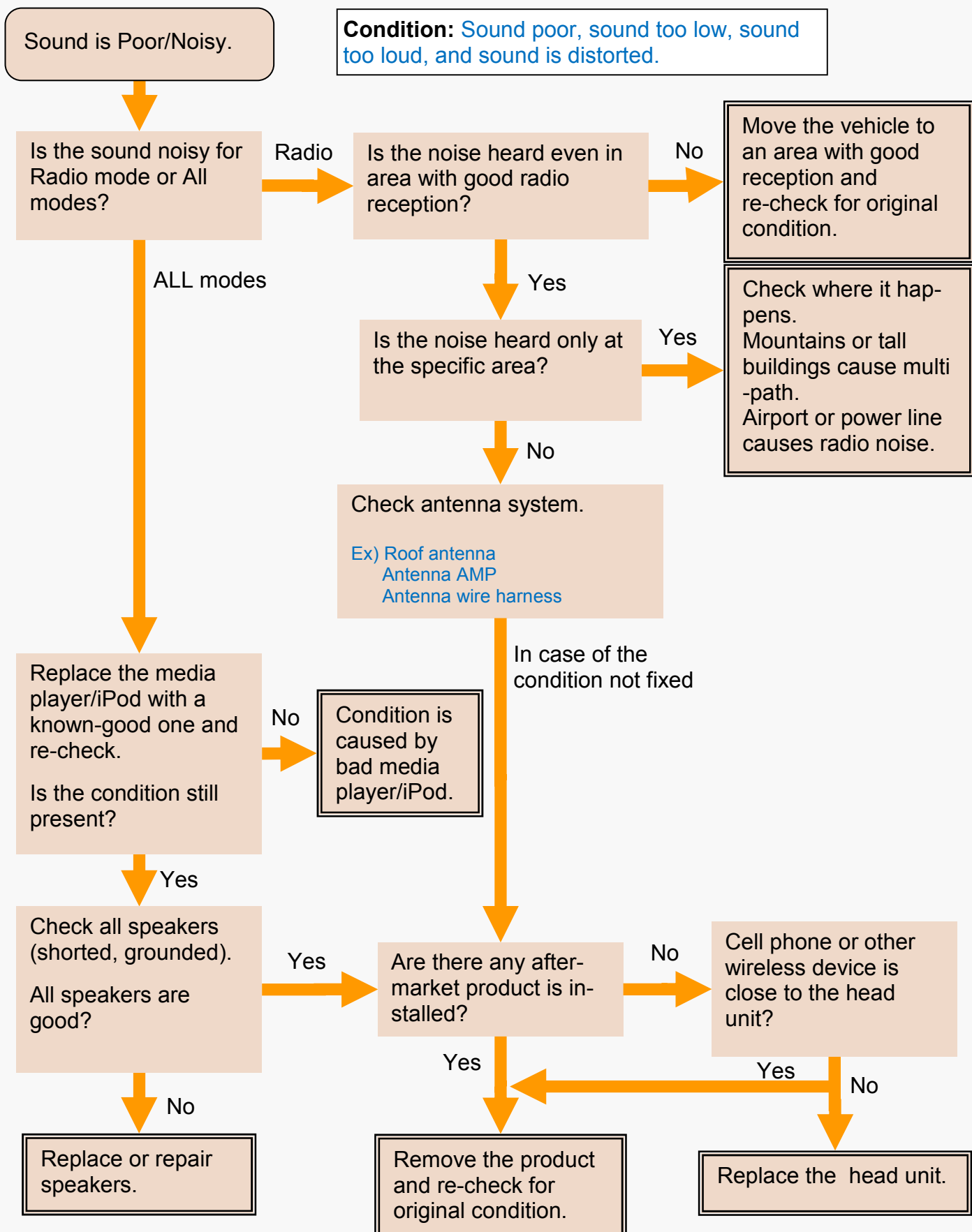

2. Troubleshooting

NO ILLUMINATION

Condition: No front panel button illumination / When headlights are on, does not change to night mode.

Note:

1. "UART" and "CAN" are not shown for 86271FJ630/730 and 86201FJ660/760
2. "GPS" will indicate "NG" on non-Navigation equipped Infotainment systems

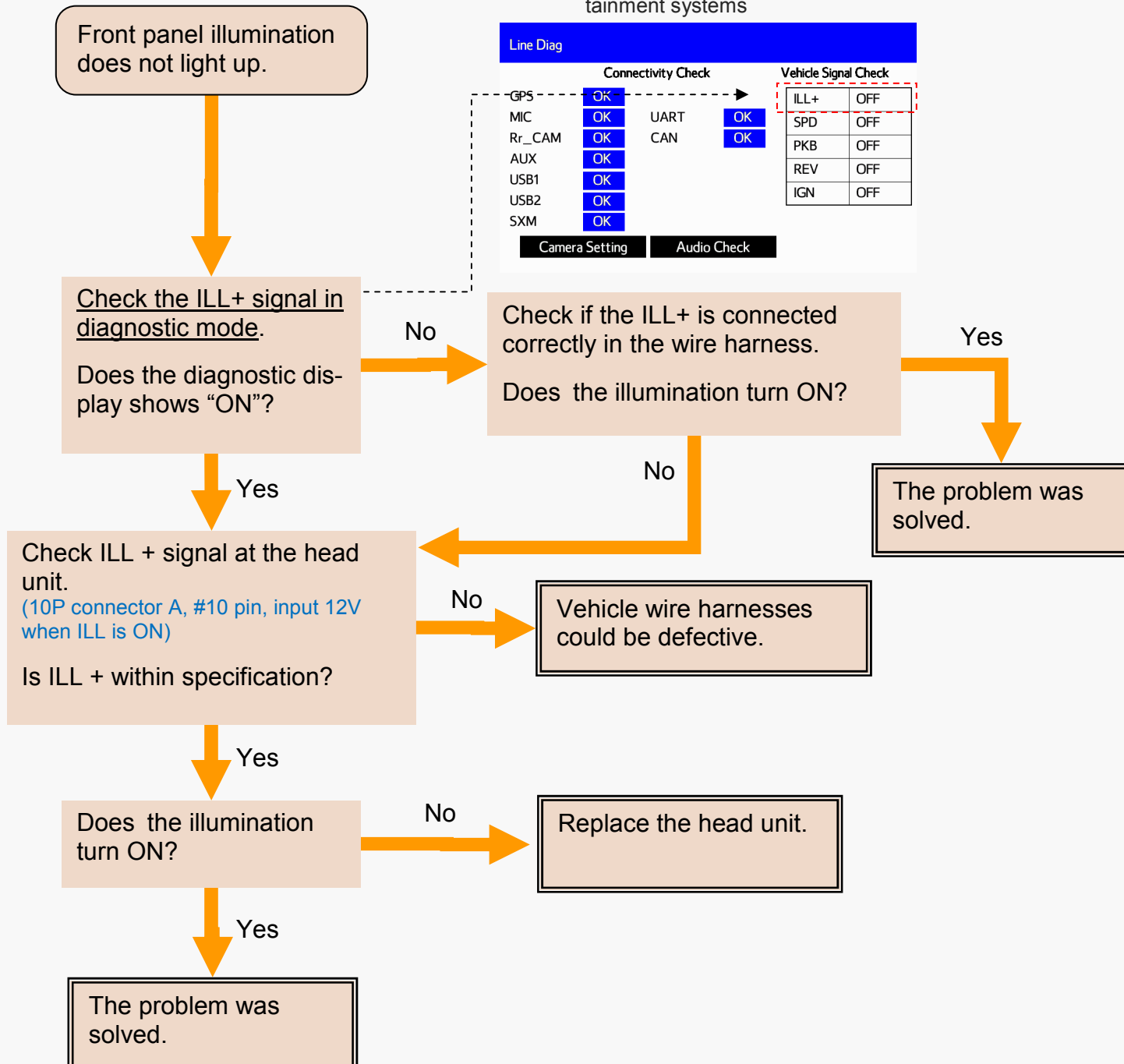

2. Troubleshooting

NO MAP IS DISPLAYED (NAV UNIT ONLY)

Condition: Audio is heard, but no map image is on screen.

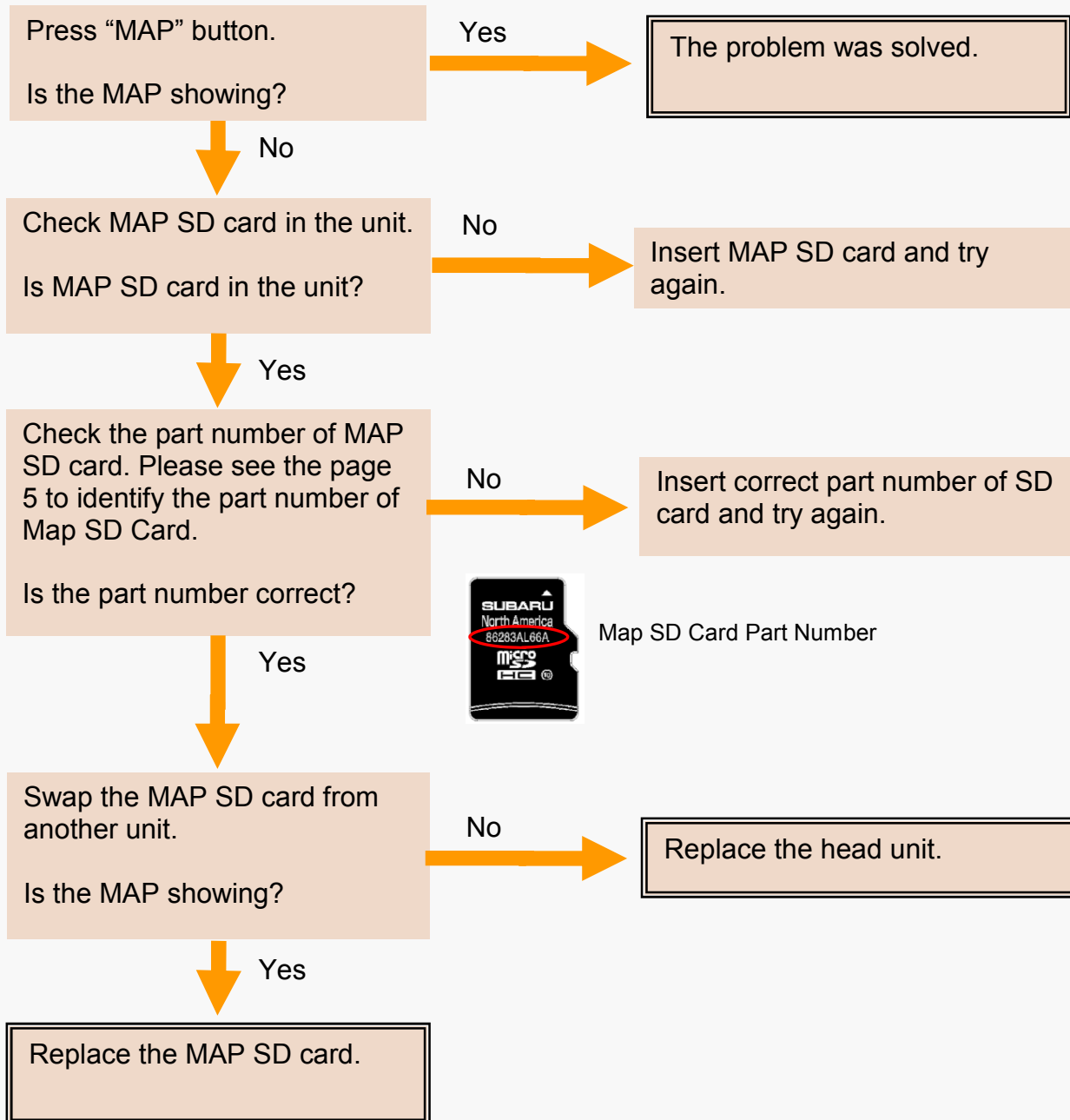

2. Troubleshooting

POOR OR NO RESPONSE FROM TOUCH SCREEN

Condition: Poor or no response when touching the screen

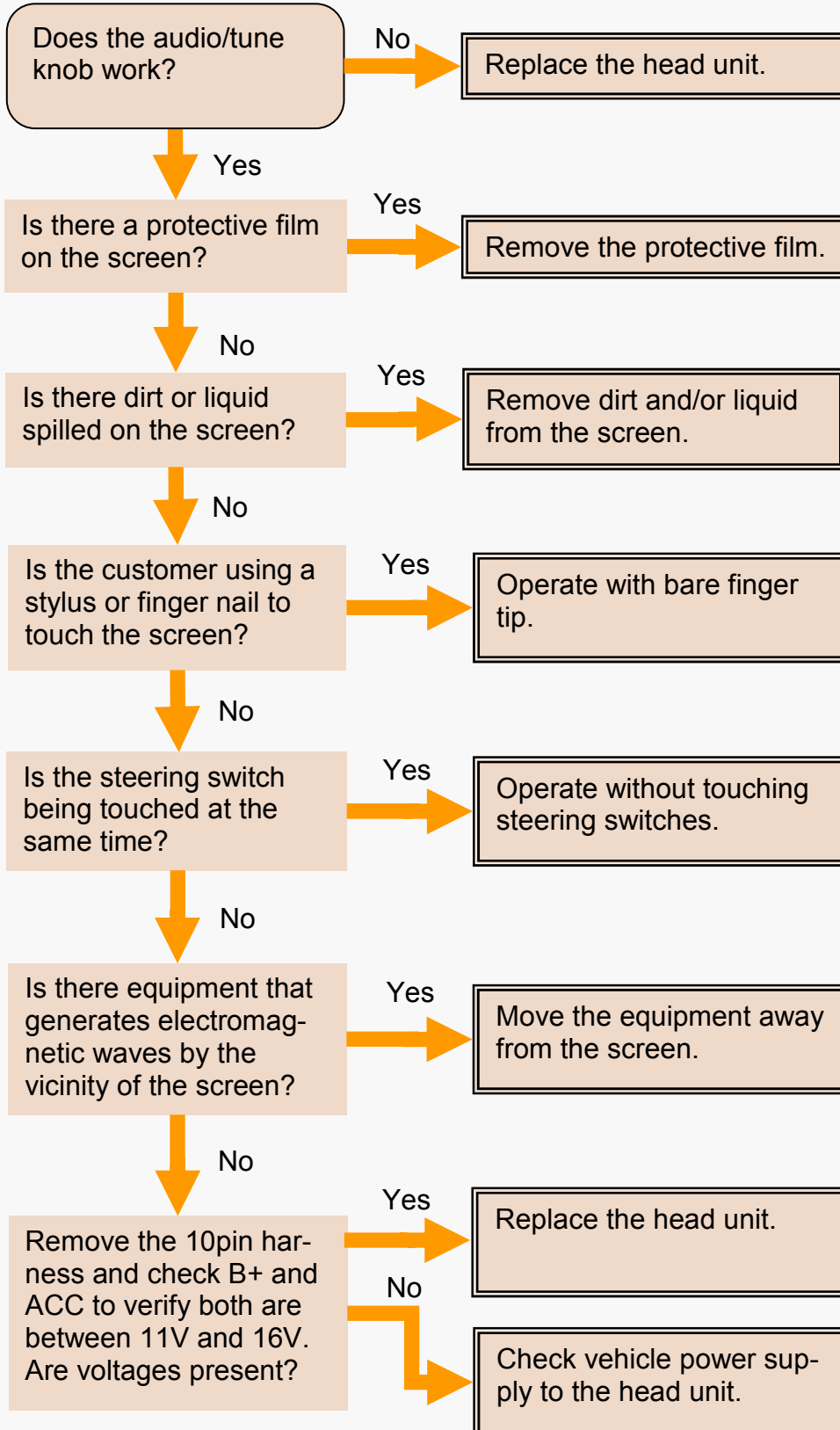

2. Troubleshooting

CURRENT GPS POSITION DOES NOT MOVE

Condition: Vehicle position icon is inaccurate / Vehicle position icon doesn't move

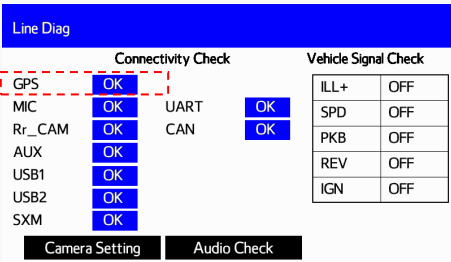
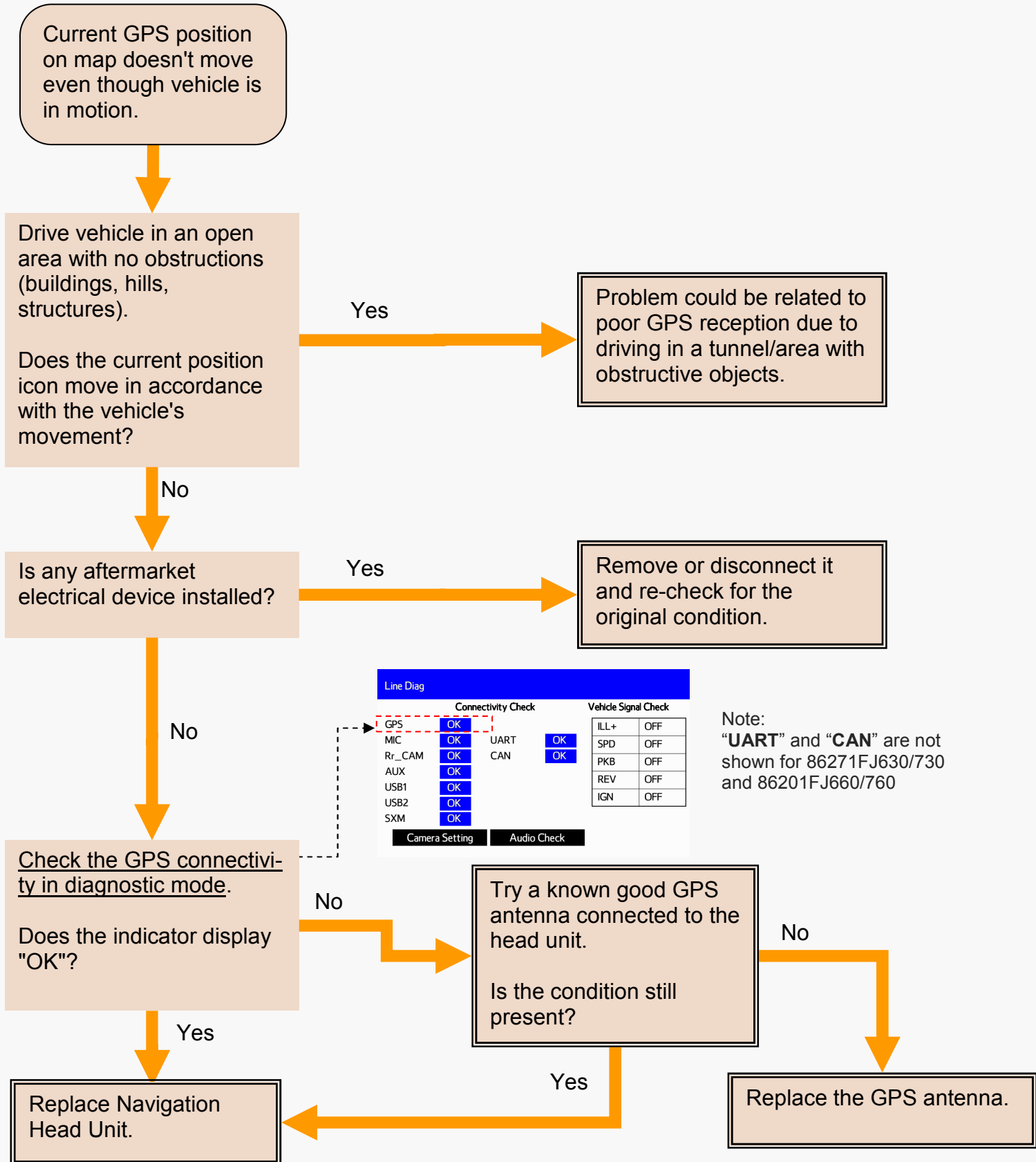

Note: "UART" and "CAN" are not shown for 86271FJ630/730 and 86201FJ660/760

2. Troubleshooting

BLUETOOTH DOES NOT WORK

Condition: Bluetooth device will not pair to the system

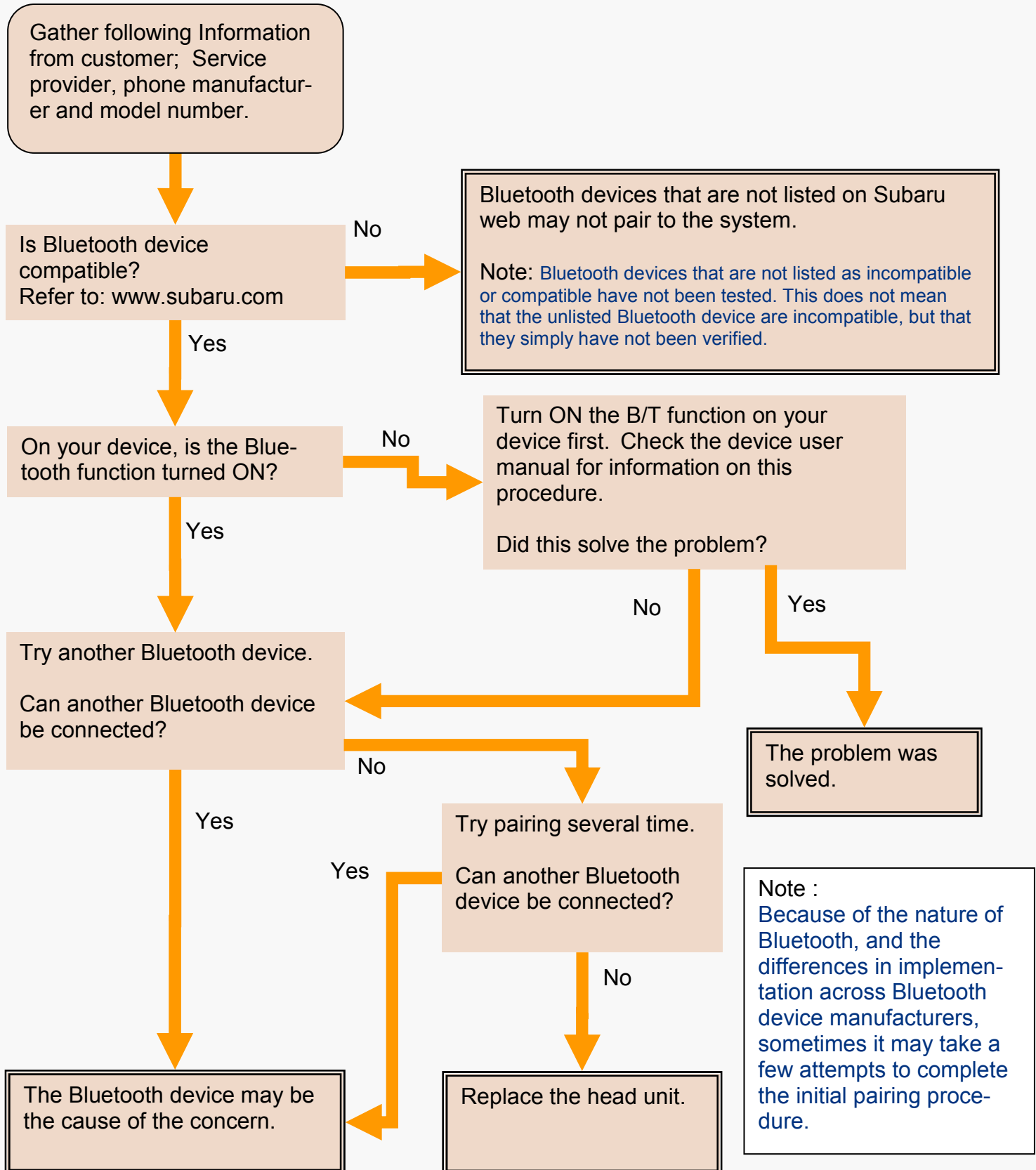

2. Troubleshooting

REAR VIEW CAMERA WON'T DISPLAY (AVN)

Condition: **Rear View video does not show or is distorted onscreen**

Rear view camera won't display or shows lines and/or distortion on screen when in reverse.

When the vehicle is in reverse, does the Map screen change to another screen?

Yes

No

Check the REV connectivity in diagnostic mode.

When reverse gear is selected, does REV show "ON"?

No

Yes

Set a tester before ACC is ON and check CB+ at the head unit right after ACC is ON. (5P connector C CB+, #2 pin, output 6V)

Is it within specification?

Yes

No

Replace the head unit.

Check the rear view camera and re-connect.
And check the connectivity in diagnostic mode.
If it is not restored, the rear view camera needs to be examined and/or replaced.

Line Diag		Connectivity Check		Vehicle Signal Check	
GPS	OK	UART	OK	ILL+	OFF
MIC	OK	CAN	OK	SPD	OFF
Rr_CAM	OK			PKB	OFF
AUX	OK			REV	ON
USB1	OK			IGN	OFF
USB2	OK				
SXM	OK				

Camera Setting Audio Check

Note:
"UART" and "CAN" are not shown for 86271FJ630/730 and 86201FJ660/760

Check the reverse harness or vehicle side condition.

The rear view camera and harness between the head unit and rear view camera needs to be examined and/or replaced.

2. Troubleshooting

REAR VIEW CAMERA WON'T DISPLAY (DA)

Condition: **Rear View video does not show or is distorted onscreen**

Rear view camera won't display or shows lines and/or distortion on screen when in reverse.

When the vehicle is in reverse, does the Map screen change to another screen?

Yes

Check the rear view camera and re-connect.
And check the connectivity in diagnostic mode.
If it is not restored, the rear view camera needs to be examined and/or replaced.

No

Check the REV connectivity in diagnostic mode.

When reverse gear is selected, does REV show "ON"?

No

Yes

Set a tester before ACC is ON and check CB+ at the head unit right after ACC is ON. (5P connector C CB+, #2 pin, output 6V)

Is it within specification?

Yes

No

Replace the head unit.

Line Diag		Connectivity Check		Vehicle Signal Check	
GPS	NG	UART	OK	ILL+	OFF
MIC	OK	CAN	OK	SPD	OFF
Rr_CAM	OK			PKB	OFF
AUX	OK			REV	ON
USB1	OK			IGN	OFF
USB2	OK				
SXM	OK				

Camera Setting Audio Check

Note:

1. "UART" and "CAN" are not shown for 86271FJ630/730 and 86201FJ660/760
2. "GPS" will indicate "NG" on non-Navigation equipped Infotainment systems

Check the reverse harness or vehicle side condition.

The rear view camera and harness between the head unit and rear view camera needs to be examined and/or replaced.

2. Troubleshooting

STARLINK APP NOT WORKING

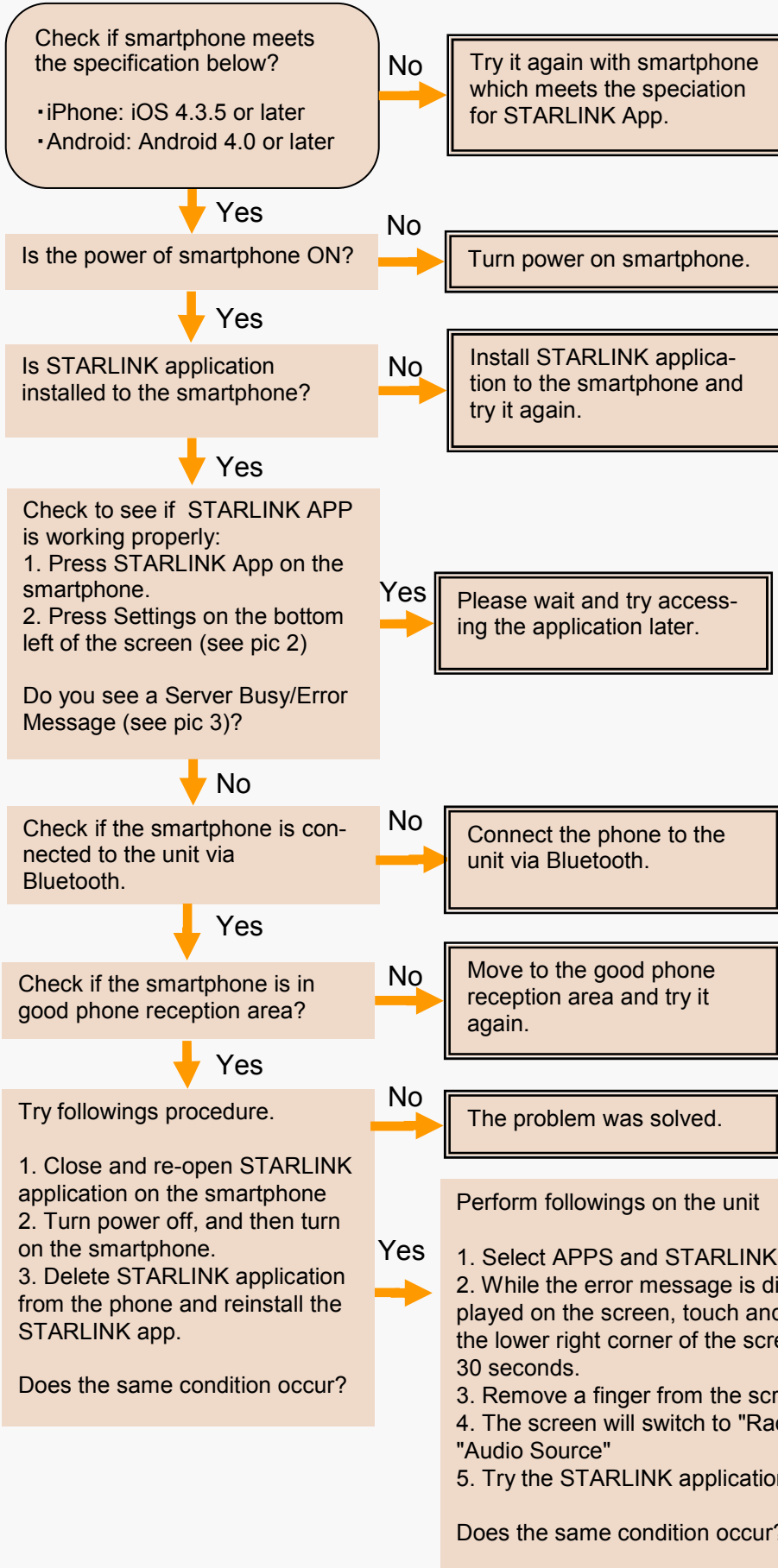

Condition:

- Displays error message (see pic 1)
- STARLINK App (application) stops
- Power of phone turns off while operating STARLINK App
- Bluetooth disconnects while operating STARLINK App
- Wireless data service is terminated while operating STARLINK App
- No or Poor phone reception while operating STARLINK App

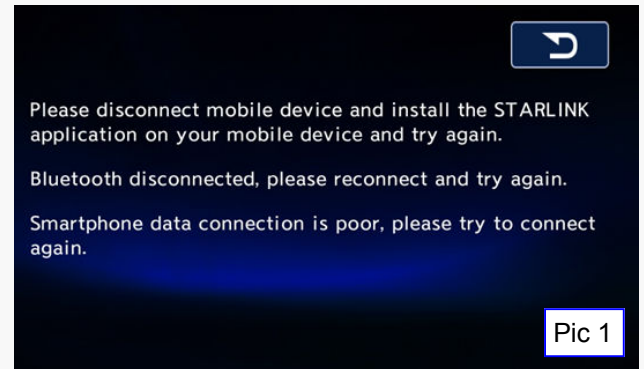

Pic 1

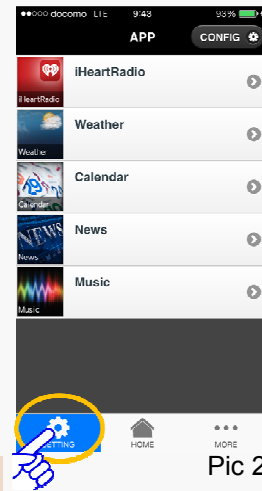

Pic 2

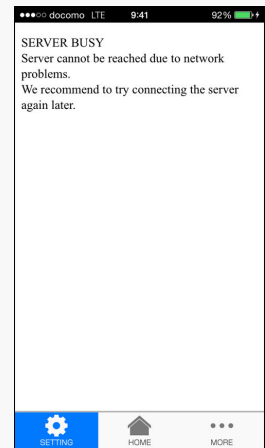

Pic 3

2. Troubleshooting

STARLINK APPS SCREEN WILL NOT DISPLAY

Condition: After pressing STARLINK a white screen is displayed

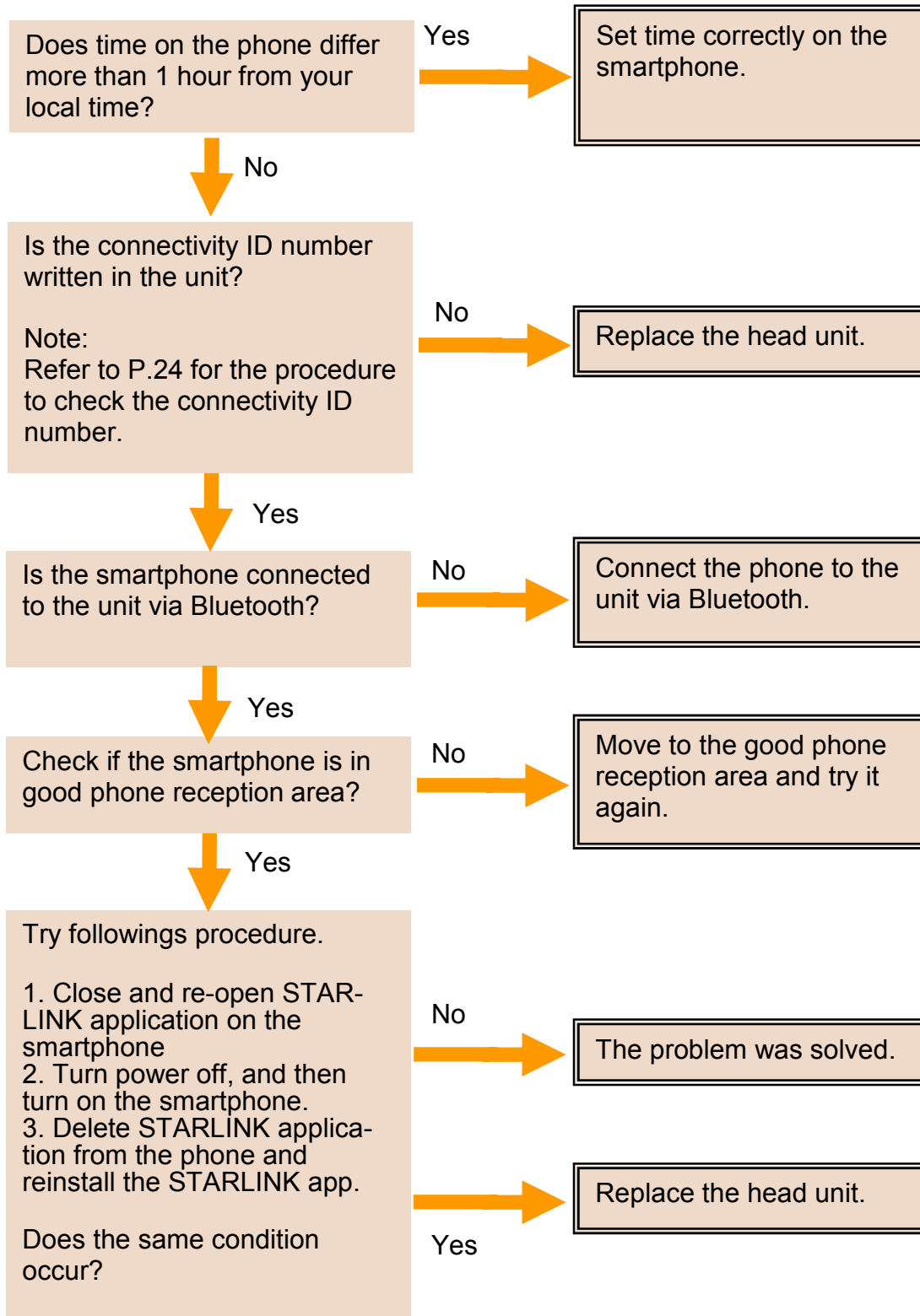

2. Troubleshooting

STARLINK DISPLAYS NO IMAGES

Condition: After pressing STARLINK, images are not shown.

Perform followings on the unit.

1. Select APPS and STARLINK.
2. While the error message is displayed on the screen, touch and hold the lower right corner of the screen for 30 seconds.
3. Remove a finger from the screen.
4. The screen will switch to "Radio" or "Audio Source"
5. Try the STARLINK Application.

Does the same condition occur?

No

The problem was solved.

Yes

Replace the head unit.

Does the same condition occur?

No

The problem was solved.

Yes

Contact Clarion USA.

2. Troubleshooting

MIRRORLINK APP DOES NOT WORK

Condition: Mirrorlink App is grayed out

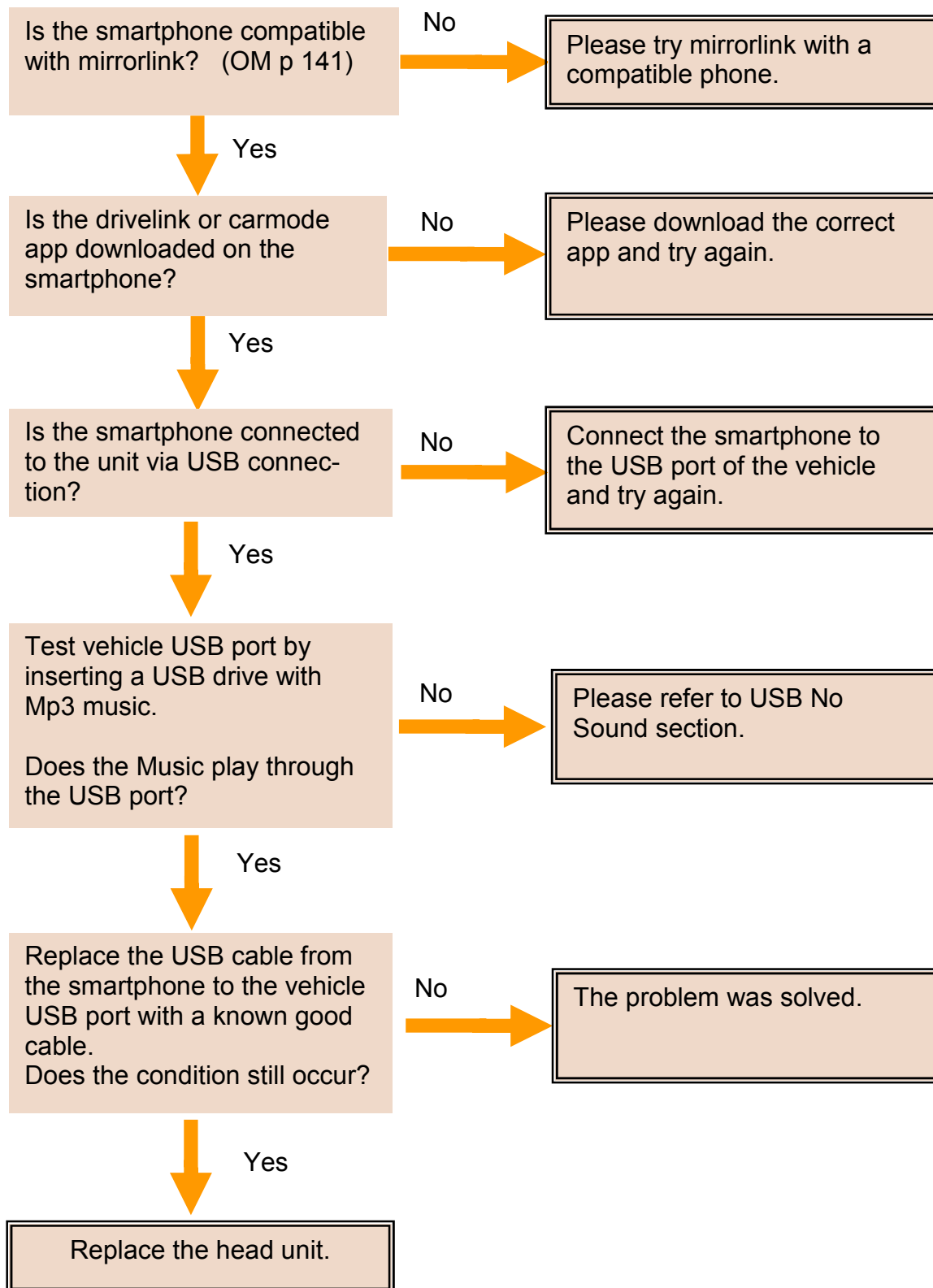

2. Troubleshooting

aha RADIO - Caution Message

Caution Message:

Please make sure the aha app is running on your mobile device.

Symptoms:

- aha application shuts down by itself.
- Unable to enter aha Mode.

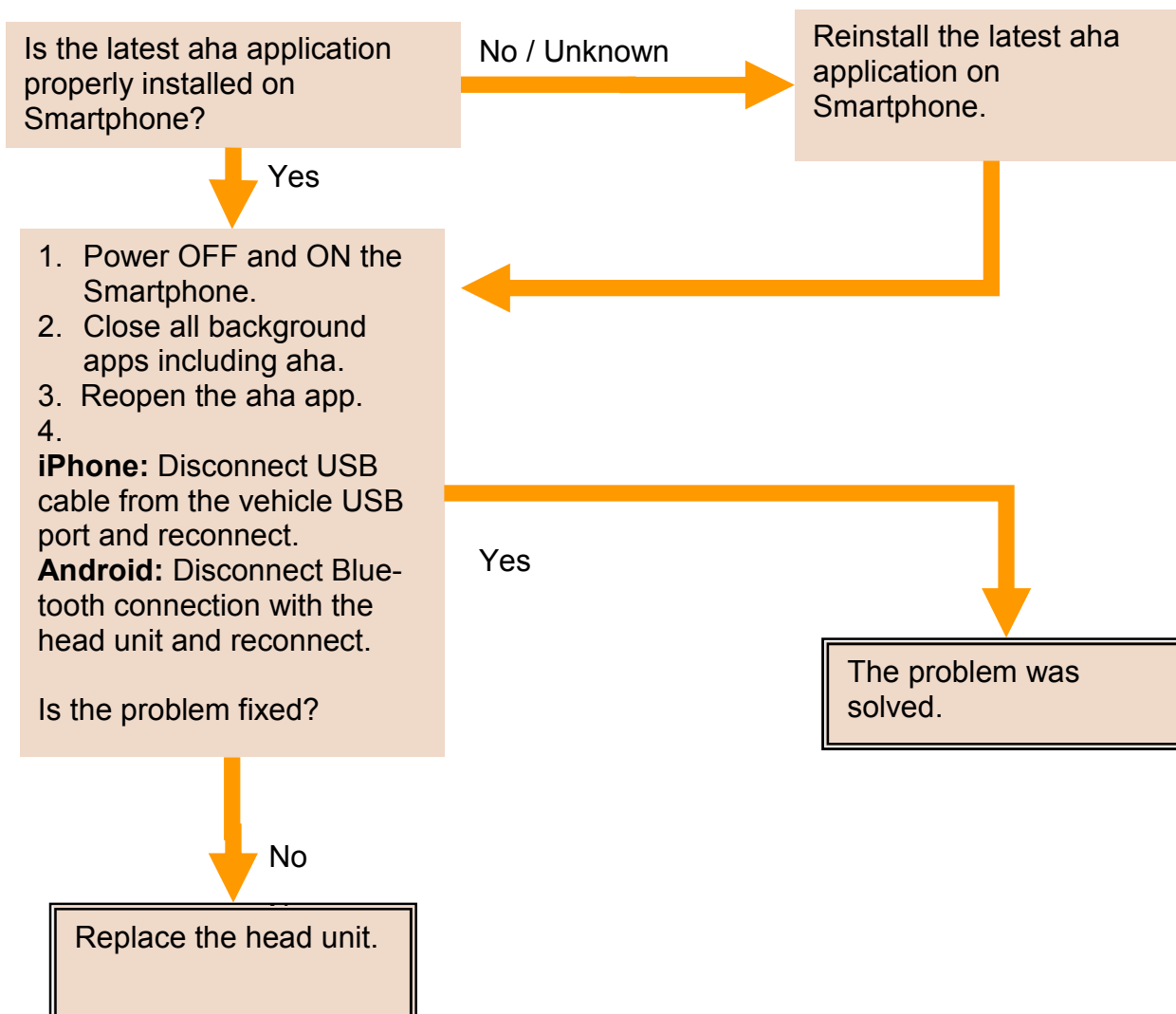

2. Troubleshooting

aha RADIO - Caution Message

Caution Message:

Please update your aha application.

Symptom:

Unable to enter aha Mode.

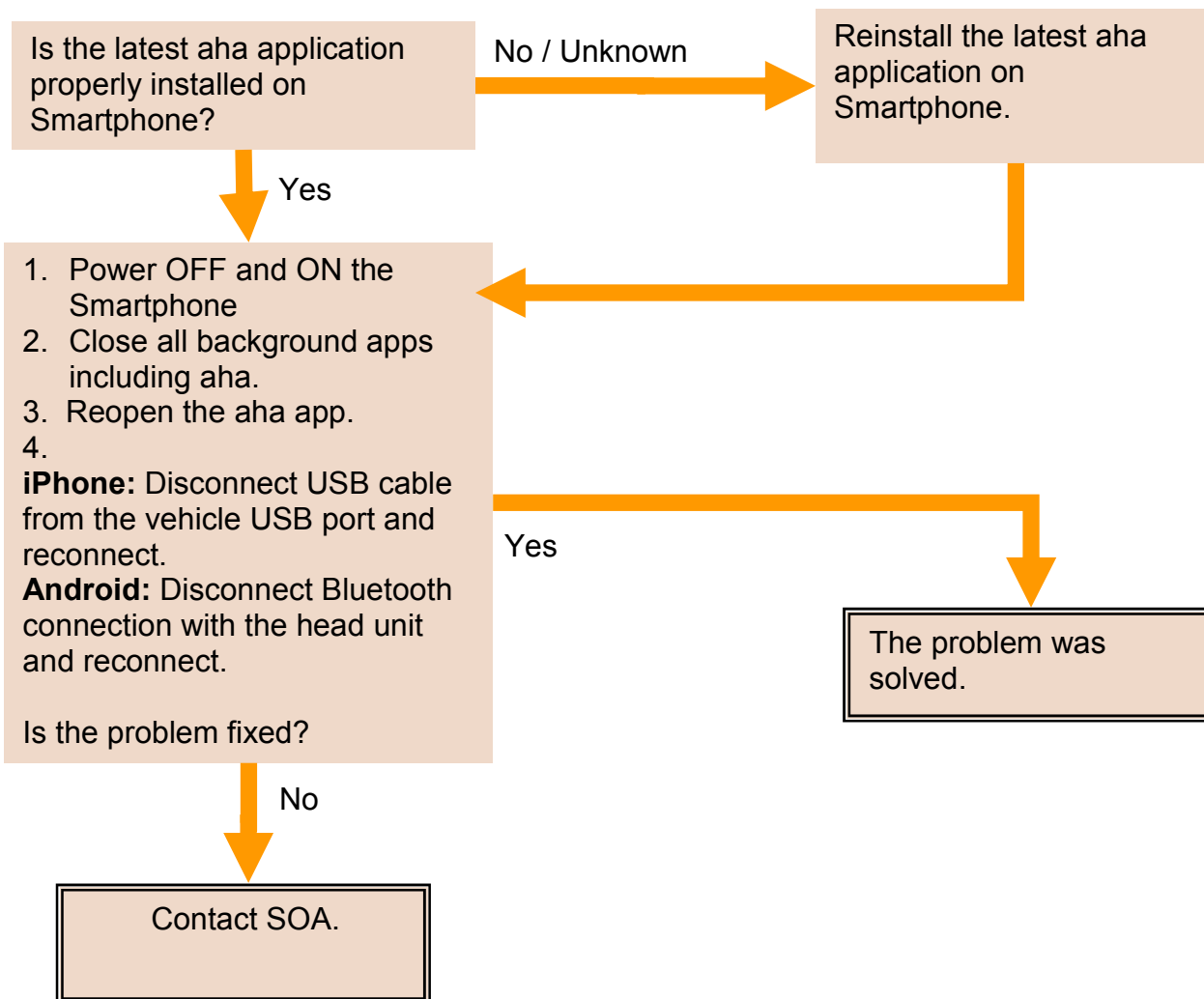

2. Troubleshooting

aha RADIO - Caution Message

Caution Message:

Please reconnect mobile device.

Symptom:

Unable to enter aha Mode on the head unit.

1. Power OFF and ON the Smartphone.
2. Close all background apps including aha.
3. Reopen the aha app.
- 4.

iPhone: Disconnect USB cable from the vehicle USB port and reconnect.

Android: Disconnect Bluetooth connection with the head unit and reconnect.

Is the problem fixed?

Yes

The problem was solved.

No

Replace the head unit.

2. Troubleshooting

aha RADIO - Caution Message

Caution Message:

Poor wireless reception.

Symptoms:

- Programs are not played on the head unit.
- Images are not shown on the head unit.

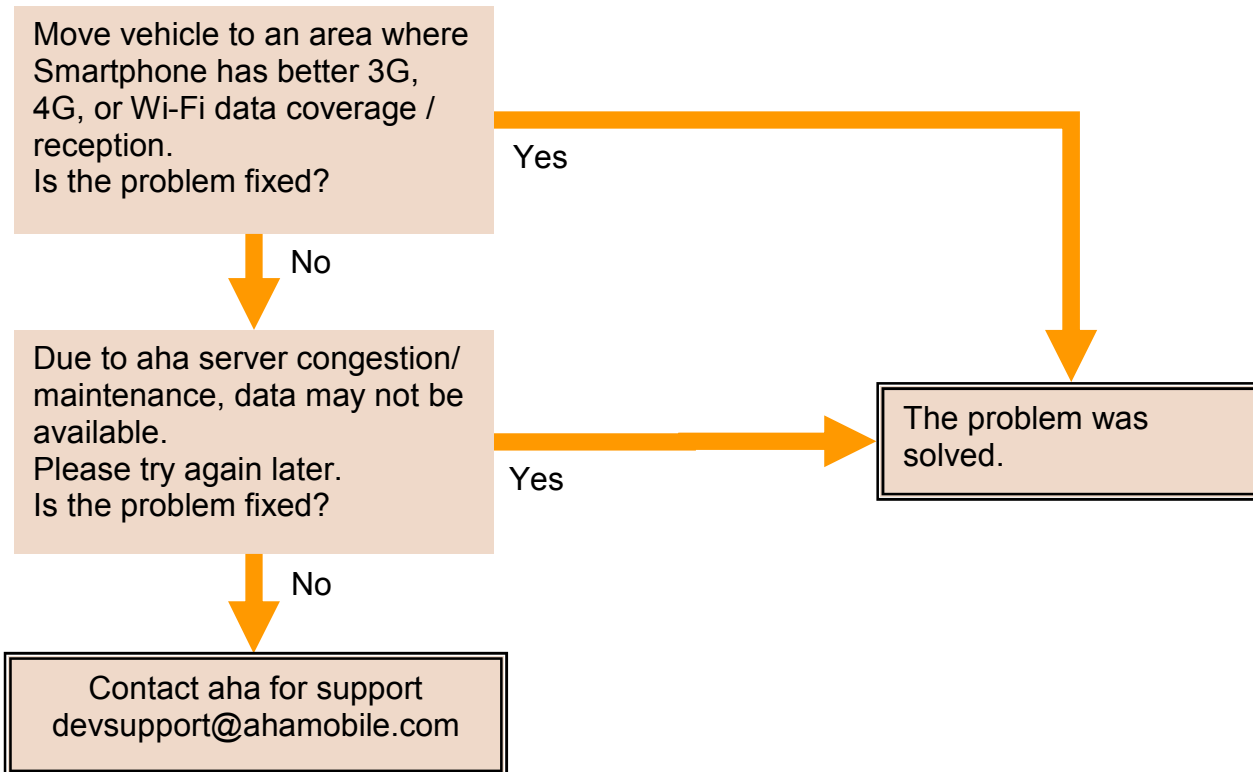

2. Troubleshooting

aha RADIO - Caution Message

Caution Message:

Entry not recognized.

Symptom:

All aha Mode functions on the head unit do not work.

1. Power OFF and ON the Smartphone
2. Close all background apps including aha.
3. Reopen the aha app.
- 4.

iPhone: Disconnect USB cable from the vehicle USB port and reconnect.

Android: Disconnect Bluetooth connection with the head unit and reconnect.

Is the problem fixed?

Yes

The problem was solved.

No

Disconnect the smart phone from the unit and try the same function on Smartphone alone.

Does the function work on the Smartphone alone?

Yes

Replace the head unit.

No

Contact aha for support
devsupport@ahamobile.com

2. Troubleshooting

aha RADIO - Caution Message

Caution Message:

Please log into the aha app.

Symptom:

Unable to enter aha Mode on the head unit

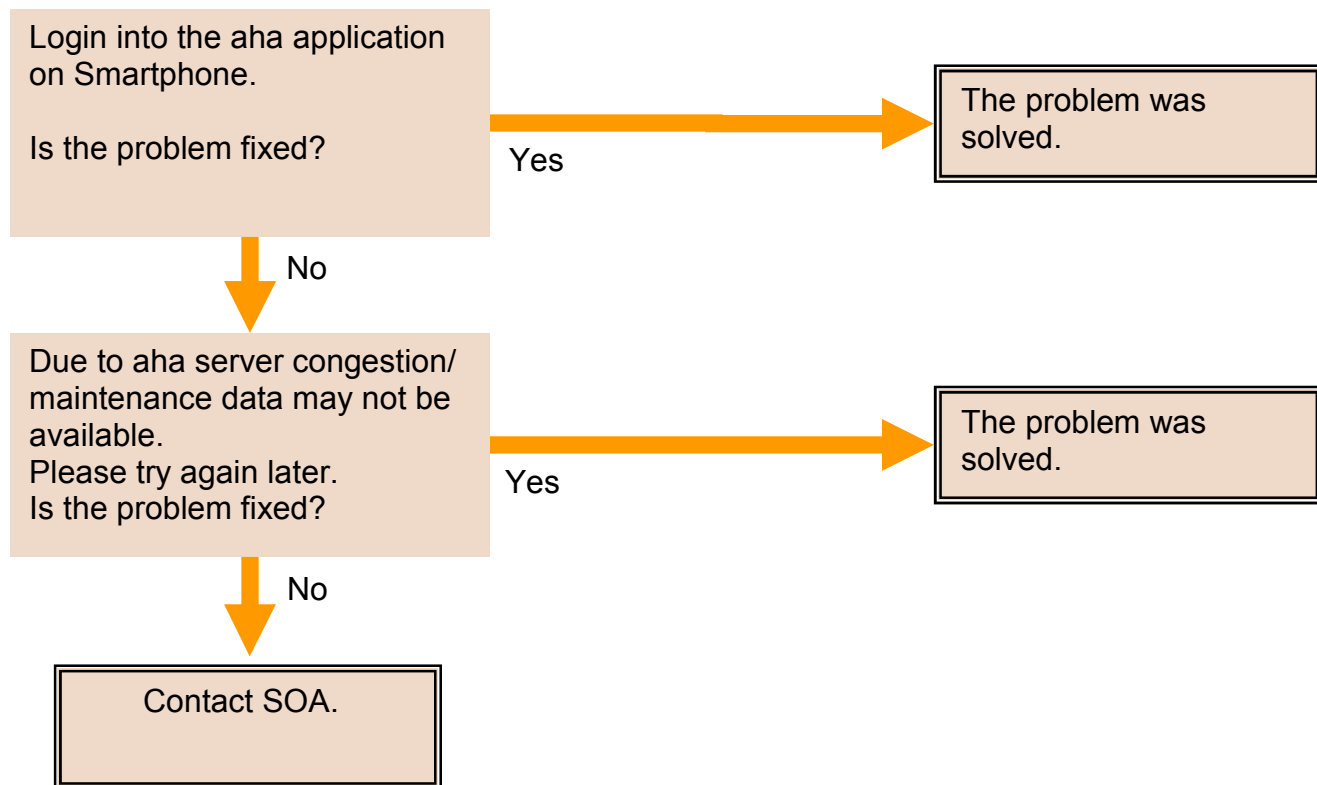

2. Troubleshooting

aha RADIO - Caution Message

Caution Message:

The station list cannot be acquired.

Symptom:

aha Radio Station List is not shown
the head unit.

1. Power OFF and ON the Smartphone
2. Close all background apps including aha.
3. Reopen the aha app.
- 4.

iPhone: Disconnect USB cable from the vehicle USB port and reconnect.

Android: Disconnect Bluetooth connection with the head unit and reconnect.

Is the problem fixed?

Yes

The problem was solved.

No

Disconnect the smart phone from the unit and try the same function on Smartphone alone.

Does the function work on the Smartphone alone?

Yes

Replace the head Unit.

No

Contact aha for support
devsupport@ahamobile.com

2. Troubleshooting

aha RADIO - Caution Message

Caution Message:

The content cannot be acquired.

Symptom:

aha Radio Content is not shown on the head unit.

Press  (Refresh button) on the head unit.

Is the problem fixed?

Yes

The problem was solved.

No

1. Power OFF and ON the Smartphone
2. Close all background apps including aha.
3. Reopen the aha app.
- 4.

iPhone: Disconnect USB cable from the vehicle USB port and reconnect.

Android: Disconnect Bluetooth connection with the head unit and reconnect.

Is the problem fixed?

Yes

The problem was solved.

No

Disconnect the smart phone from the unit and try the same function on Smartphone alone.

Does the function work on the Smartphone alone?

Yes

Replace the head unit.

No

Contact aha for support
devsupport@ahamobile.com

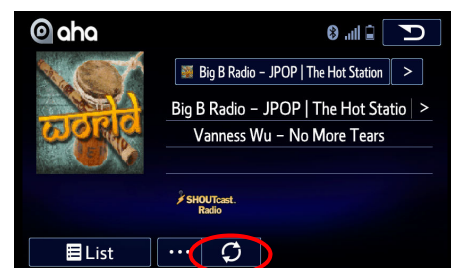

Refresh button

2. Troubleshooting

aha RADIO - Caution Message

Caution Message:

Information acquisition error.

Symptom:

aha Radio Icons or Logos are not shown the head unit.

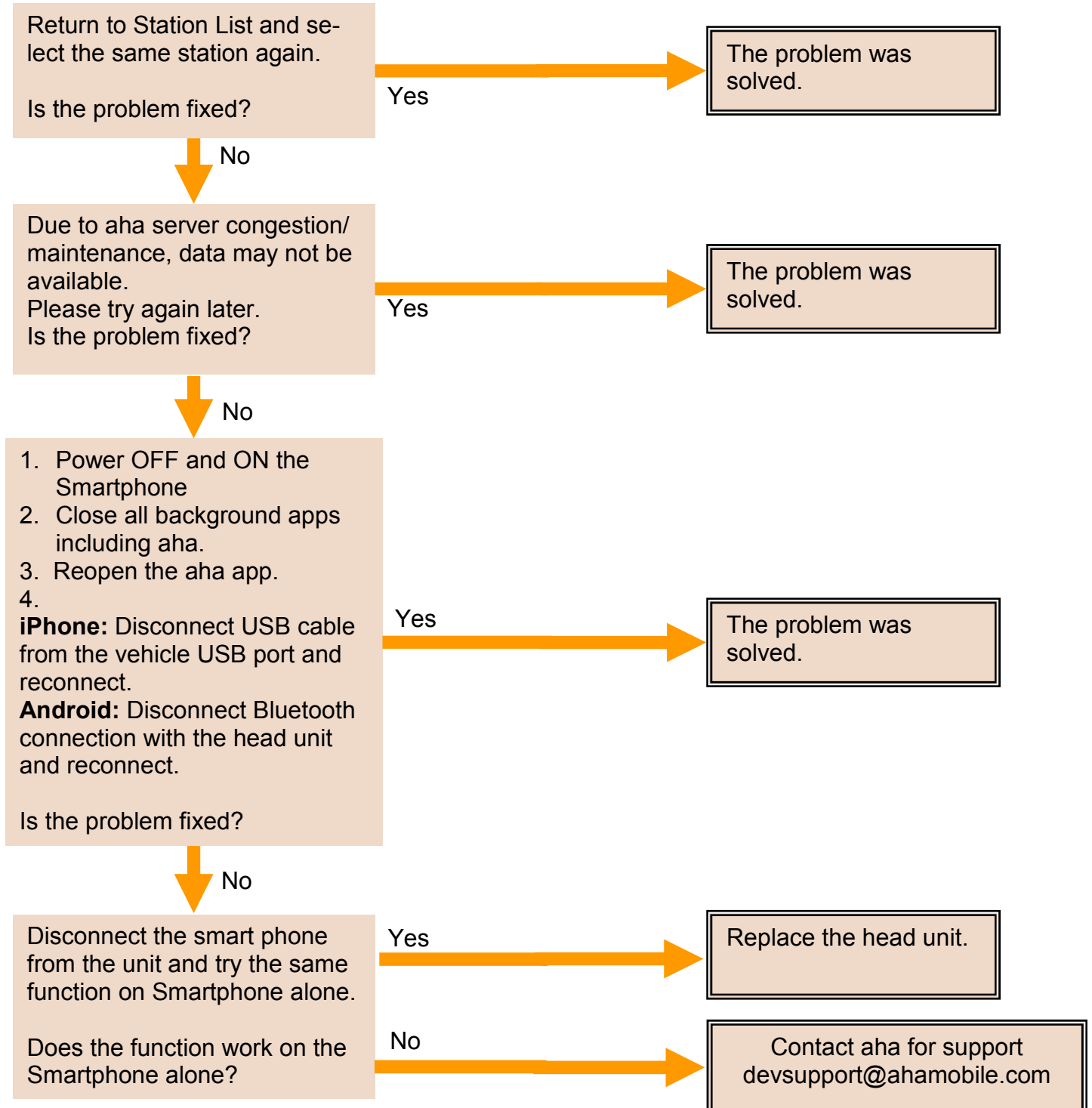

2. Troubleshooting

aha RADIO - Caution Message

Caution Message:

Action not available.

Symptom:

- All aha Mode functions do not work on the head unit.
- Forward/Reverse functions do not work on the head unit.

Due to aha server congestion/
maintenance, data may not be
available.
Please try again later.
Is the problem fixed?

Yes

The problem was
solved.

No

1. Power OFF and ON the
Smartphone
 2. Close all background apps
including aha.
 3. Reopen the aha app.
 - 4.
- iPhone:** Disconnect USB ca-
ble from the vehicle USB port
and reconnect.
Android: Disconnect Blue-
tooth connection with the head
unit and reconnect.

Yes

The problem was
solved.

Is the problem fixed?

No

Disconnect the smart phone
from the unit and try the same
function on Smartphone alone.

Yes

Replace the head unit.

Does the function work on the
Smartphone alone?

No

Contact aha for support
devsupport@ahamobile.com

2. Troubleshooting

aha RADIO - Caution Message

Caution Message:

aha Server Error - Please check connection or reception.

Symptom:

aha Radio content cannot be played on the head unit.

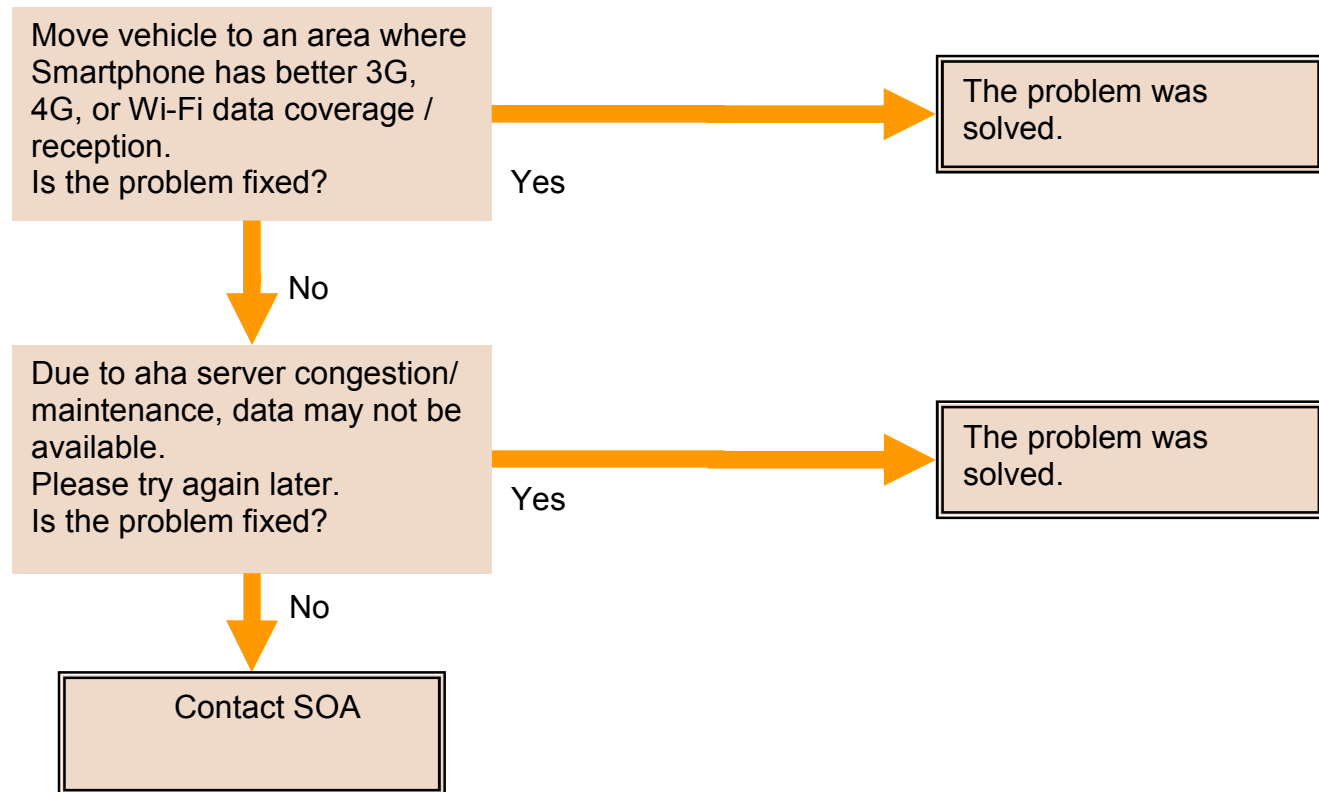

2. Troubleshooting

aha RADIO - Caution Message

Caution Message:

aha Server Down - Please try again later.

Symptom:

aha Radio content cannot be played on the head unit.

Move vehicle to an area where Smartphone has better 3G, 4G, or Wi-Fi data coverage / reception.
Is the problem fixed?

Yes

The problem was solved.

No

Contact SOA

2. Troubleshooting

aha RADIO - Caution Message

Caution Message:

**aha Station Contents Not Available -
Please Try Again Later.**

Symptom:

aha Radio content cannot be played on the head unit

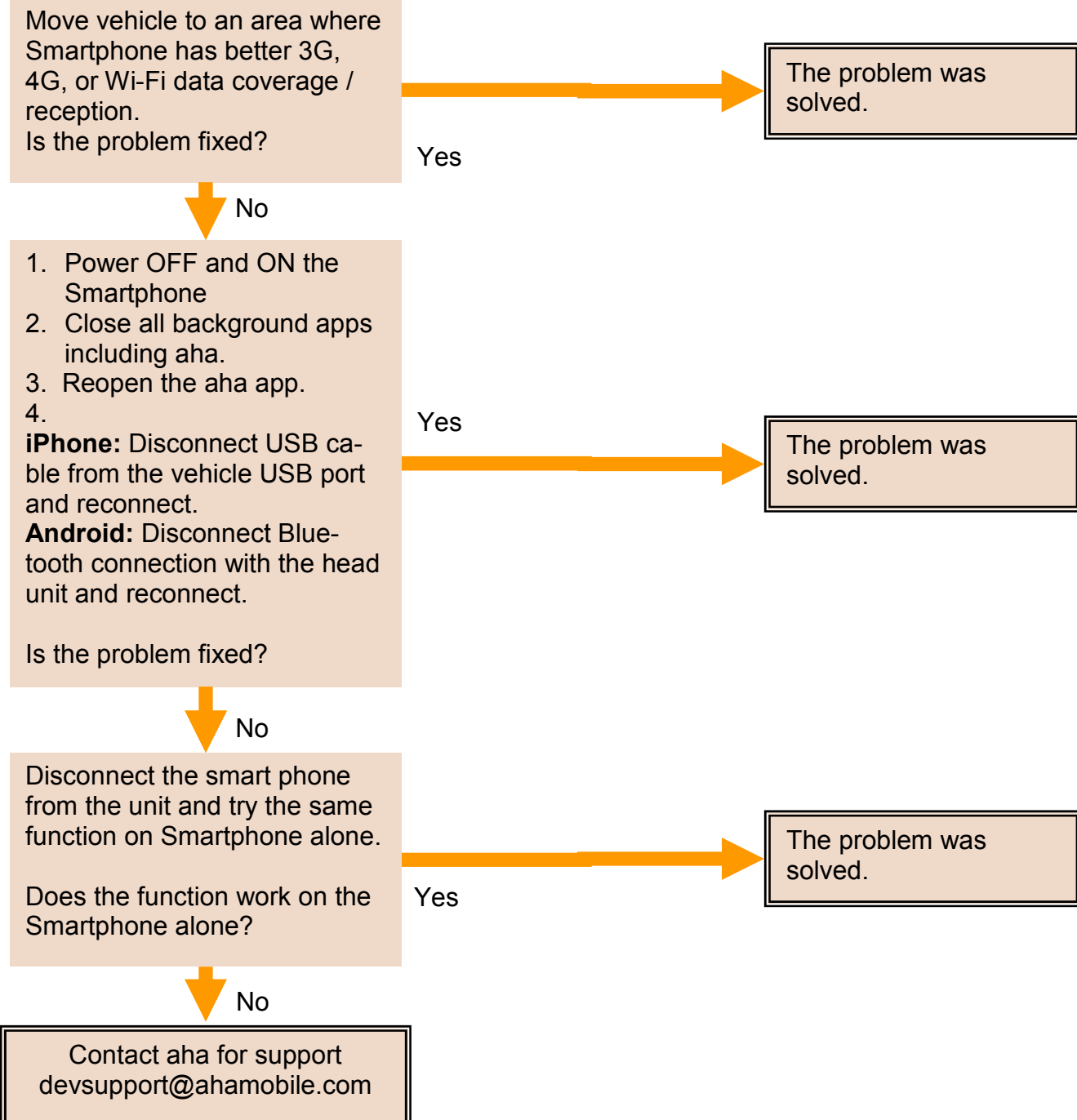

2. Troubleshooting

aha RADIO - Caution Message

Caution Message:

aha Communication Error - Please Check Owner's Manual.

Symptom:

aha Radio content cannot be played on vehicle Navigation Head Unit.

Move vehicle to an area where Smartphone has better 3G, 4G, or Wi-Fi data coverage / reception.
Is the problem fixed?

Yes

The problem was solved.

No

Due to aha server congestion/ maintenance, data may not be available.
Please try again later.
Is the problem fixed?

Yes

The problem was solved.

No

1. Power OFF and ON the Smartphone
2. Close all background apps including aha.
3. Reopen the aha app.
4.
iPhone: Disconnect USB cable from the vehicle USB port and reconnect.
Android: Disconnect Bluetooth connection with the head unit and reconnect.

Yes

The problem was solved.

Is the problem fixed?

No

Contact SOA.

2. Troubleshooting

aha RADIO - Caution Message

Caution Message:

Failed.

Symptom:

Map is not updated when pressing "Map Update" button of aha Radio on the head unit.

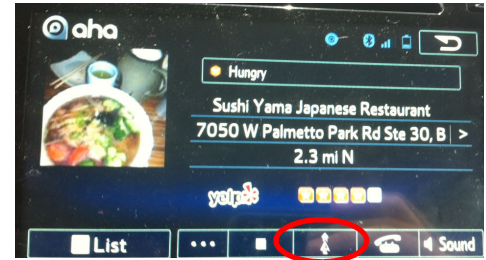

Map Update Button

Move vehicle to an area where Smartphone has better 3G, 4G, or Wi-Fi data coverage / reception.
Is the problem fixed?

Yes

The problem was solved.

No

Due to aha server congestion/ maintenance, data may not be available.
Please try again later.
Is the problem fixed?

Yes

The problem was solved.

No

1. Power OFF and ON the Smartphone
2. Close all background apps including aha.
3. Reopen the aha app.
4.
iPhone: Disconnect USB cable from the vehicle USB port and reconnect.
Android: Disconnect Bluetooth connection with the head unit and reconnect.

Yes

The problem was solved.

Is the problem fixed?

No

Disconnect the smart phone from the unit and try the same function on Smartphone alone.

Yes

Replace the head unit.

Does the function work on the Smartphone alone?

No

Contact aha for support
devsupport@ahamobile.com

2. Troubleshooting

aha RADIO - Caution Message

Caution Message:

Please select the type of connection in 'aha Settings'.

Condition:

Android device is connected via Bluetooth and iPhone is connected via USB.

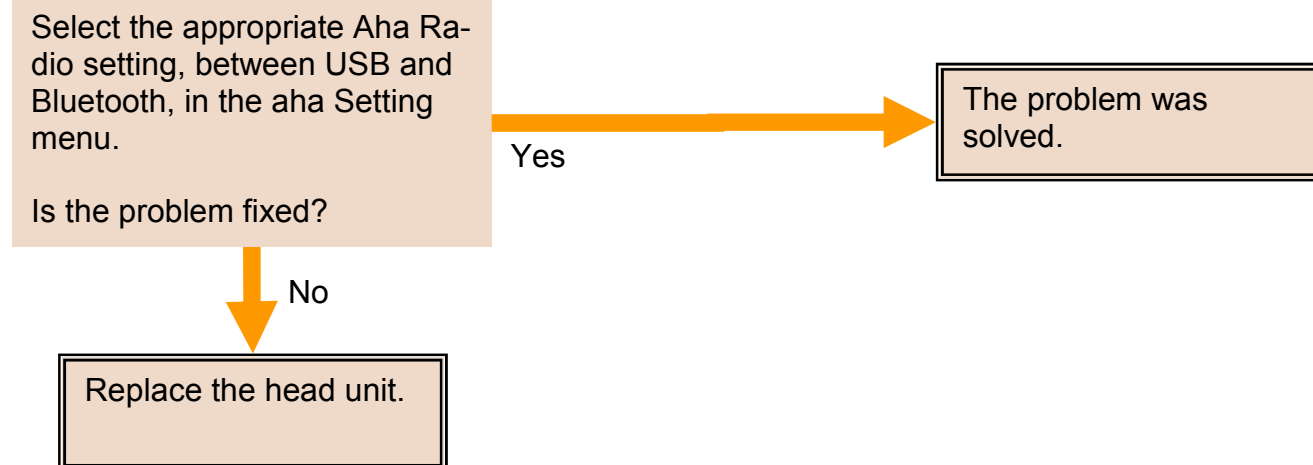

How to change “aha Radio Setting”:

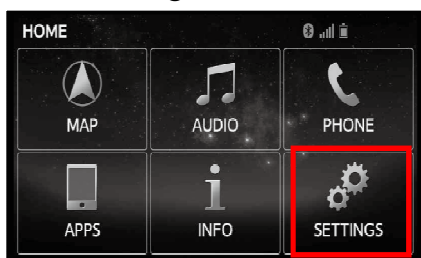

1. Press “HOME” and select “Settings”

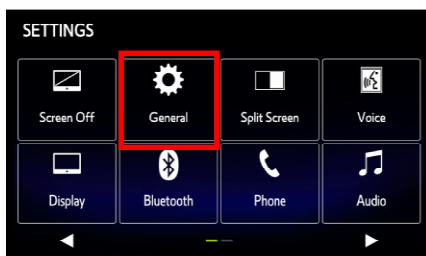

2. Select “General”

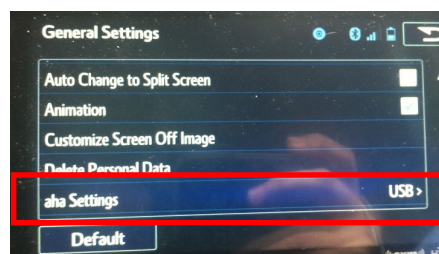

3. Select “aha Settings”

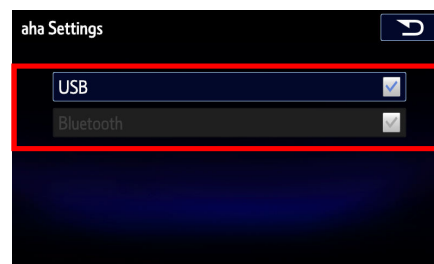

4. Select “USB” or “Bluetooth”

2. Troubleshooting

aha RADIO - Caution Message

Caution Message:

'aha Settings' change failed. Please try again later.

Symptom:

aha Radio Setting on the head unit cannot be changed.

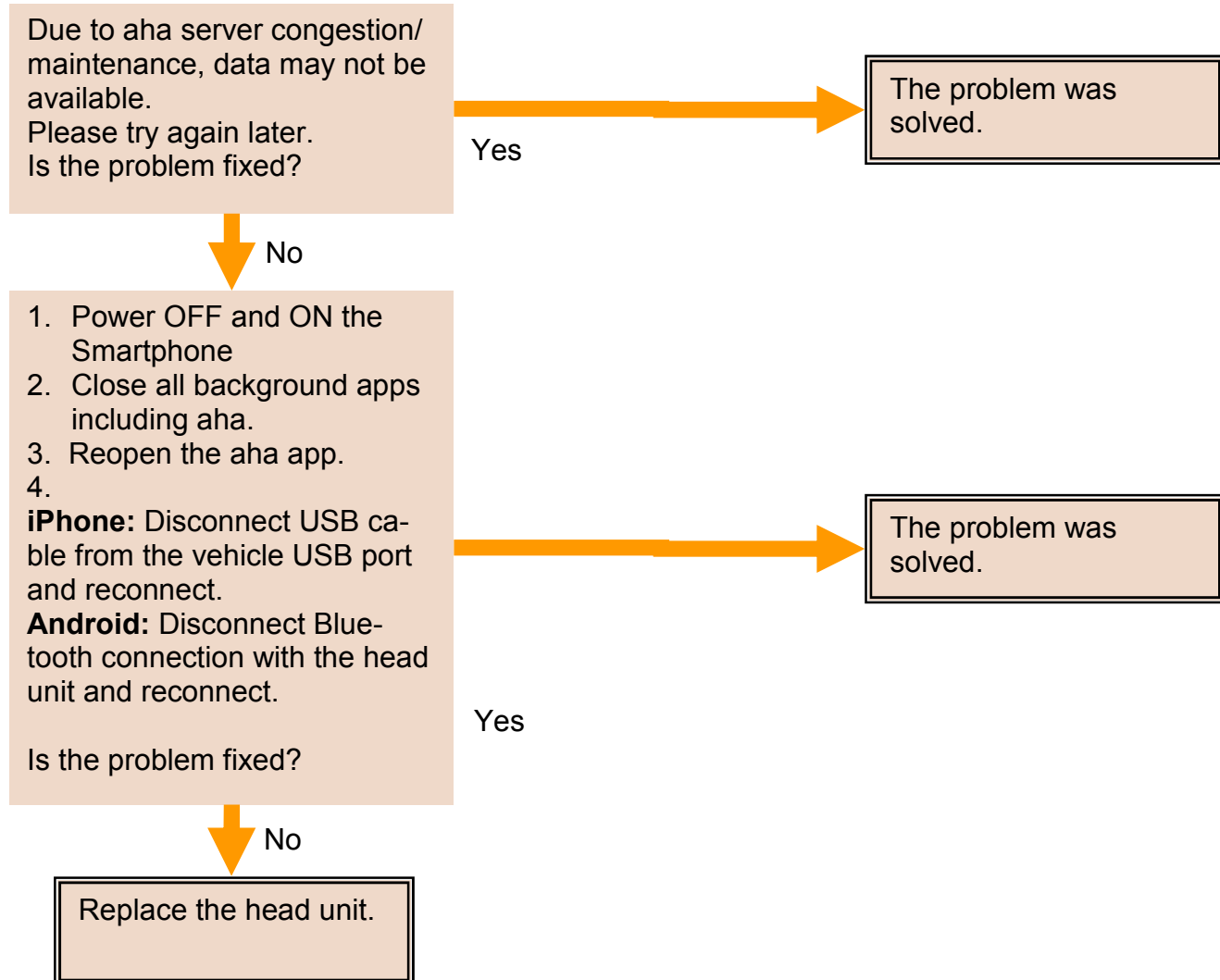

2. Troubleshooting

aha RADIO - Caution Message

Caution Message:

**Connection with aha app is not completed.
Please try again later.**

Symptom:

Voice Recognition Mode does not work for Aha Radio.

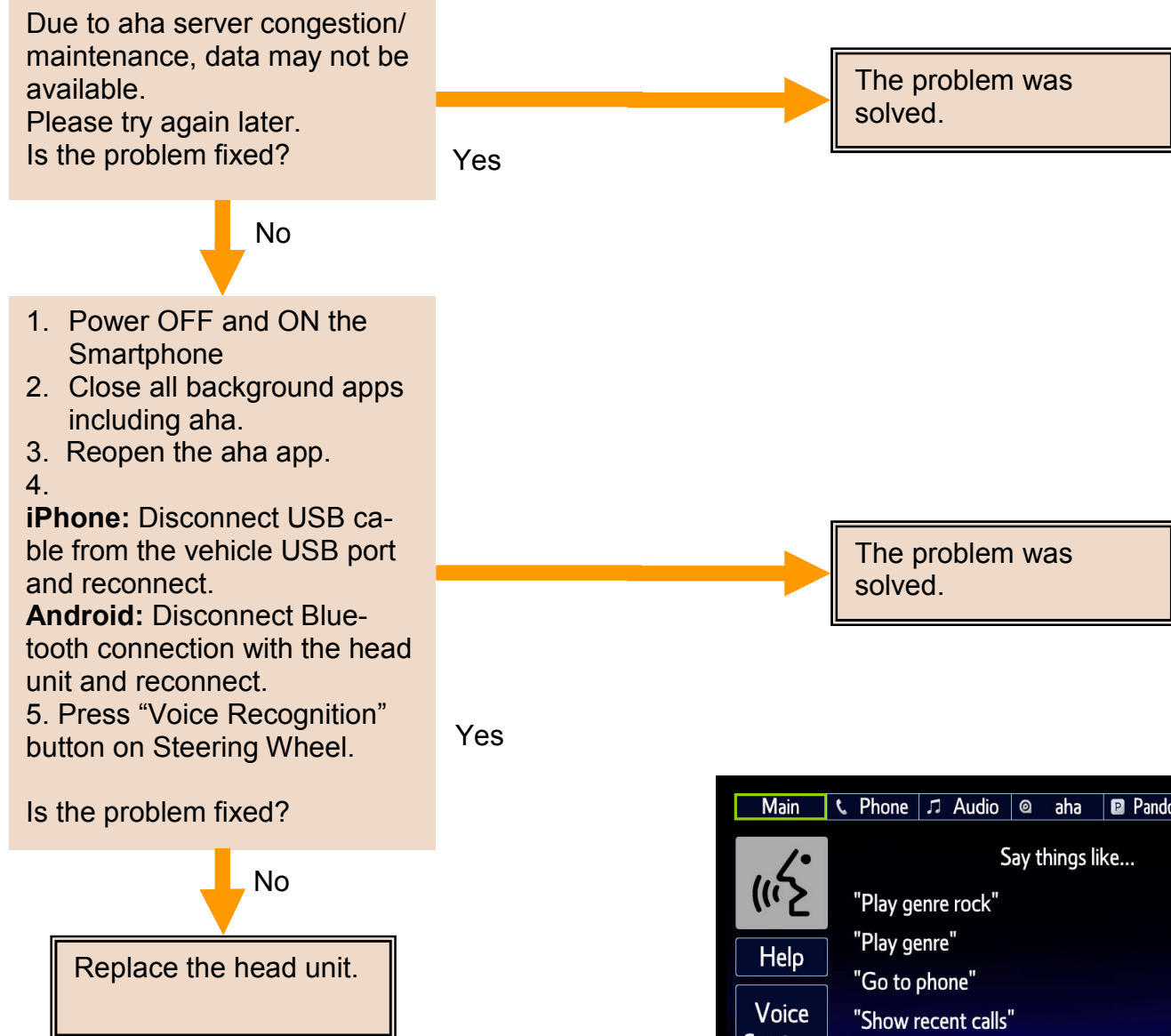

2. Troubleshooting

*Pandora RADIO - Pandora Button is Inactive/Grayed Out

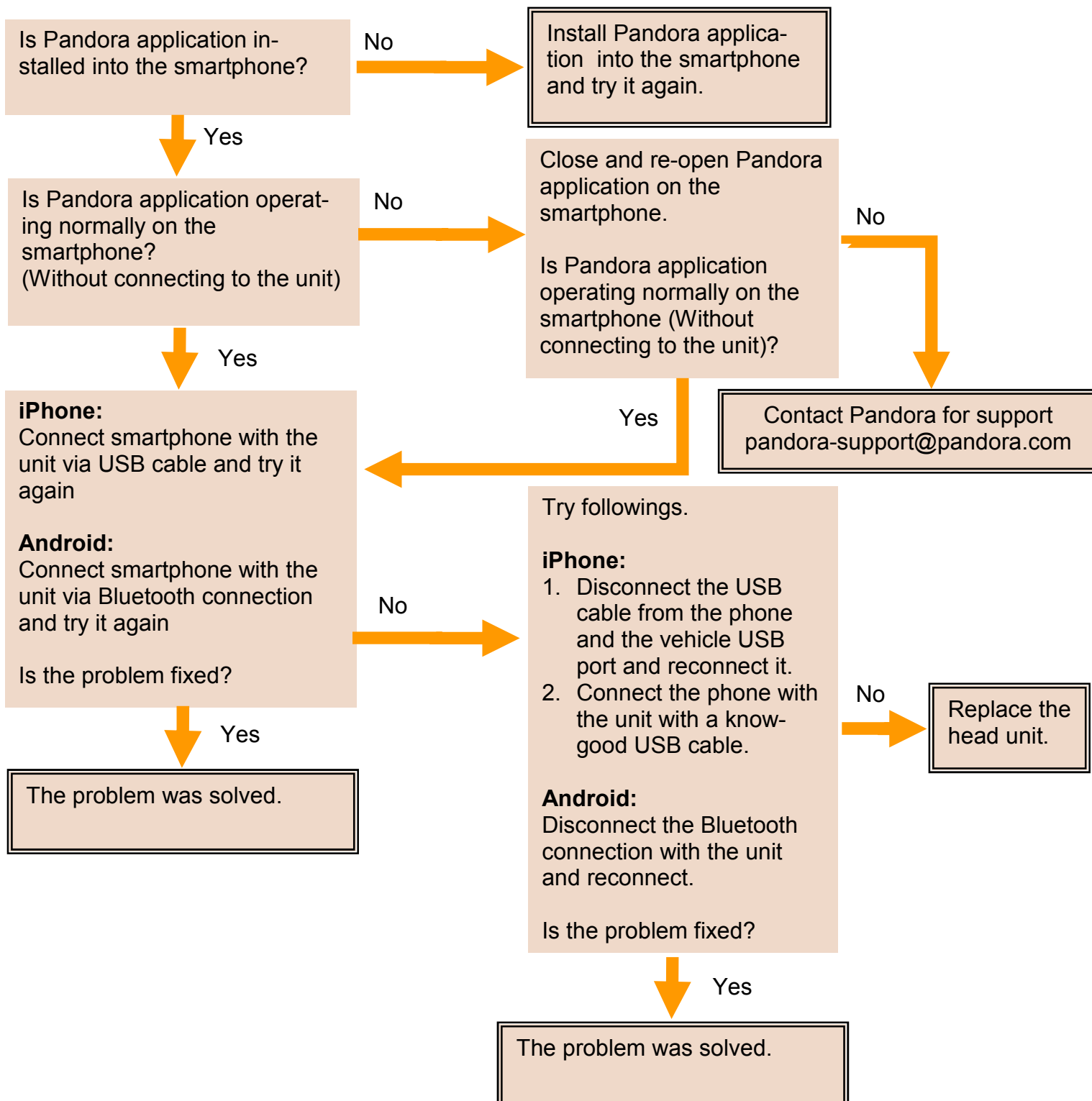

*Not available for Canadian model

2. Troubleshooting

*Pandora RADIO - Caution Message

Caution Message:

Please make sure that the Pandora app is installed correctly on your mobile device.

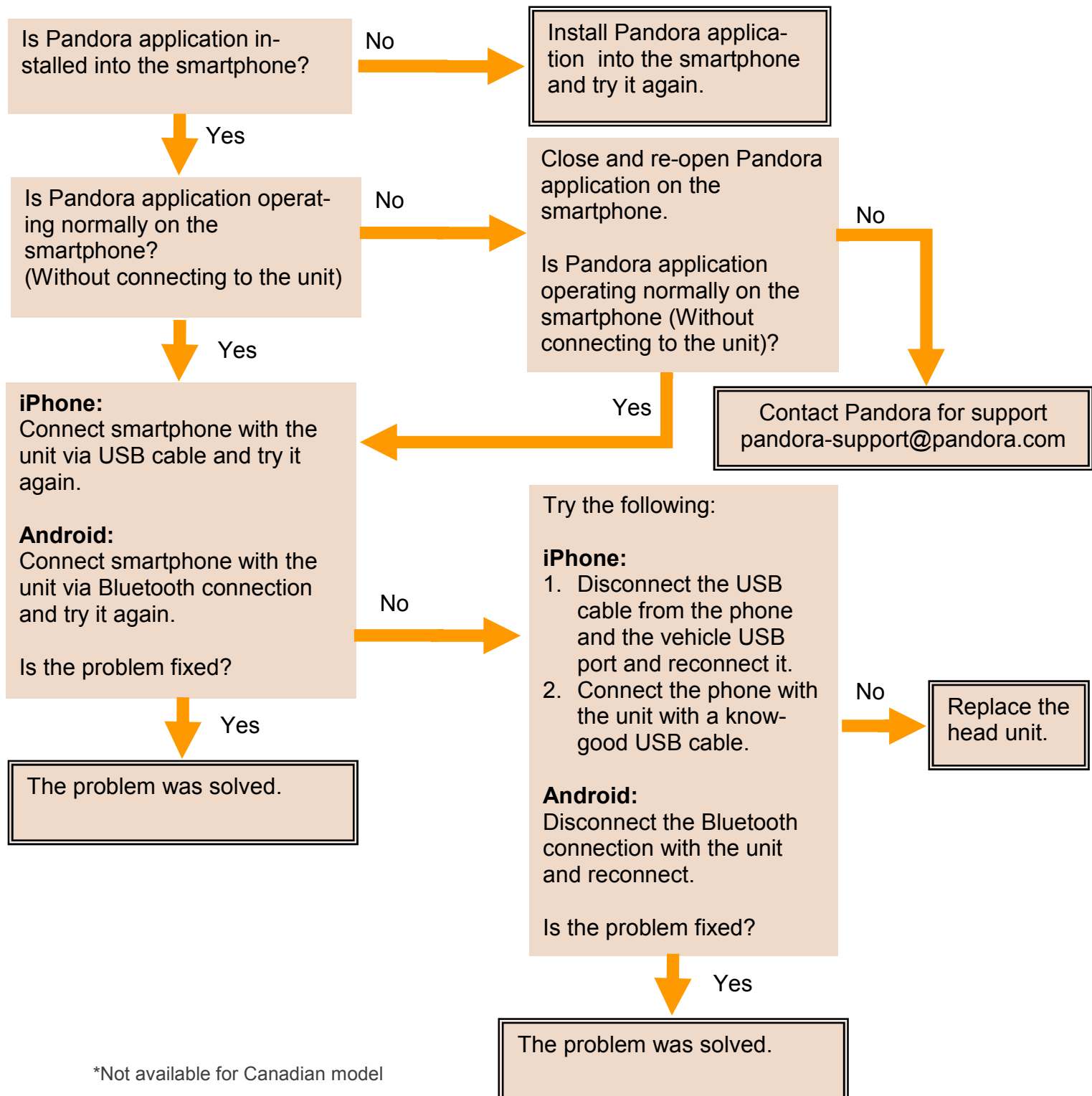

2. Troubleshooting

*Pandora RADIO - Caution Message

Caution Message:

Please update the Pandora application on your mobile device.

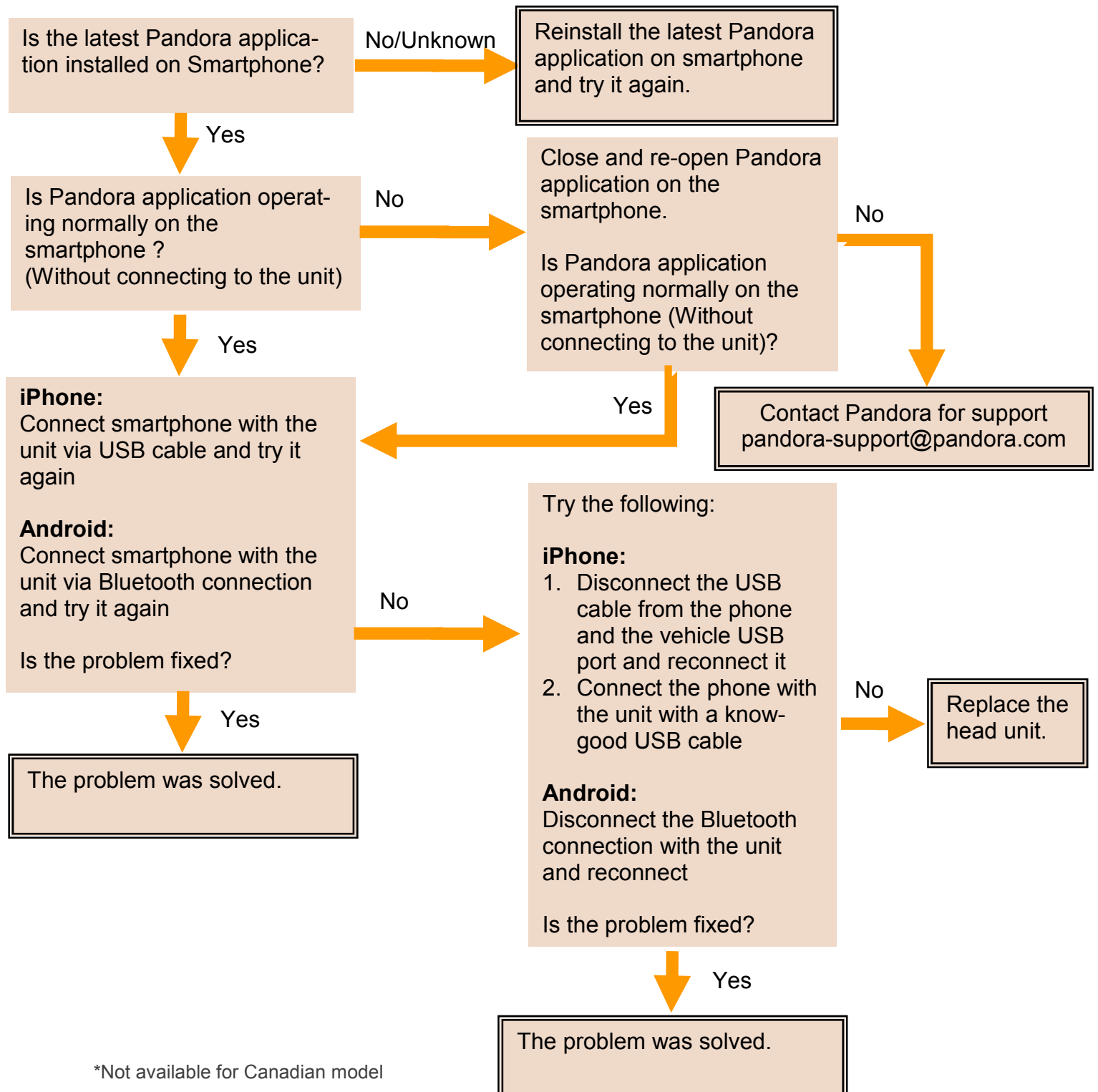

*Not available for Canadian model

2. Troubleshooting

*Pandora RADIO - Caution Message

Caution Message:

No stations have been added to your list

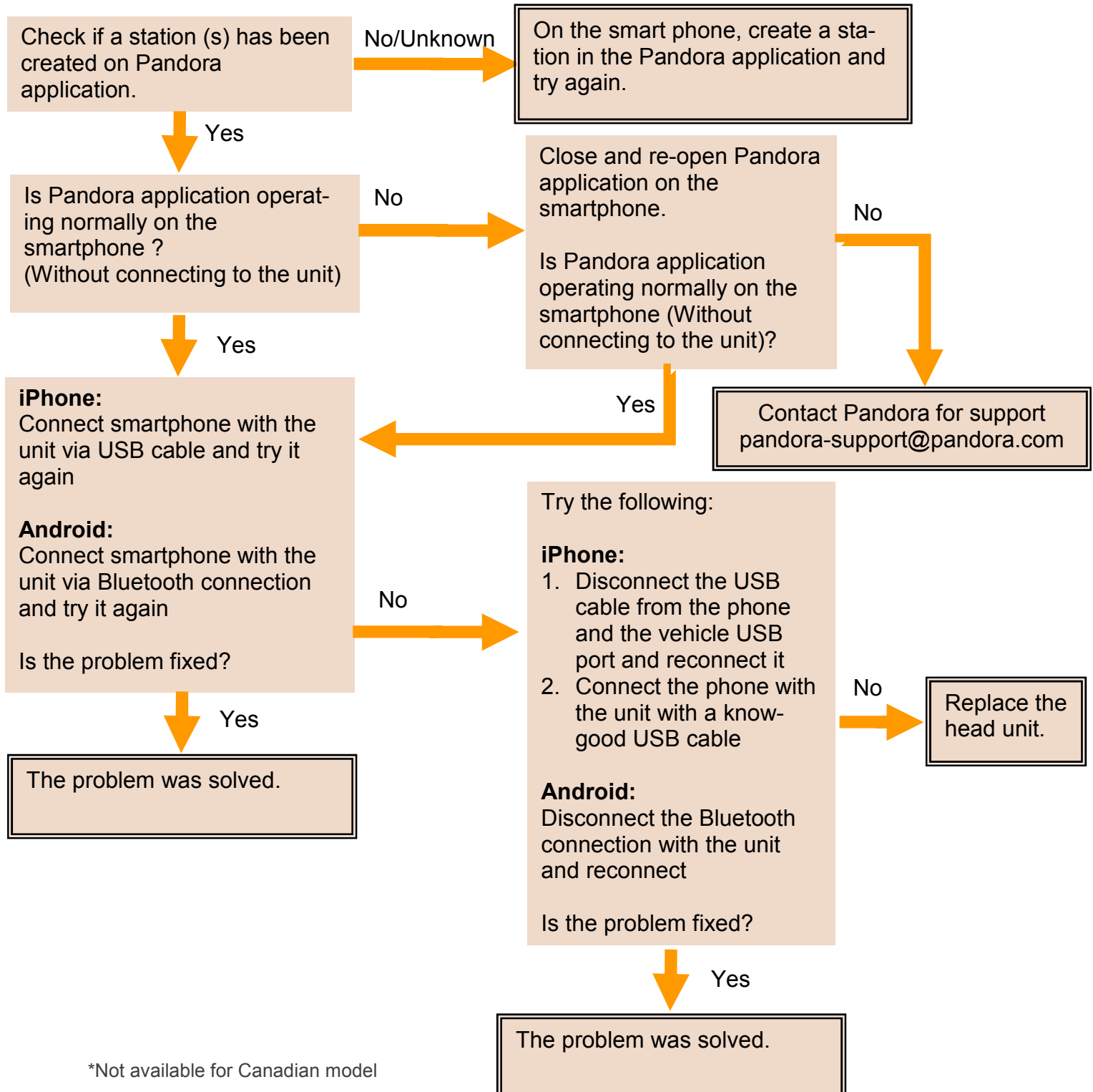

*Not available for Canadian model

2. Troubleshooting

*Pandora RADIO - Caution Message

Caution Message:

You have reached the maximum number of skipped songs.

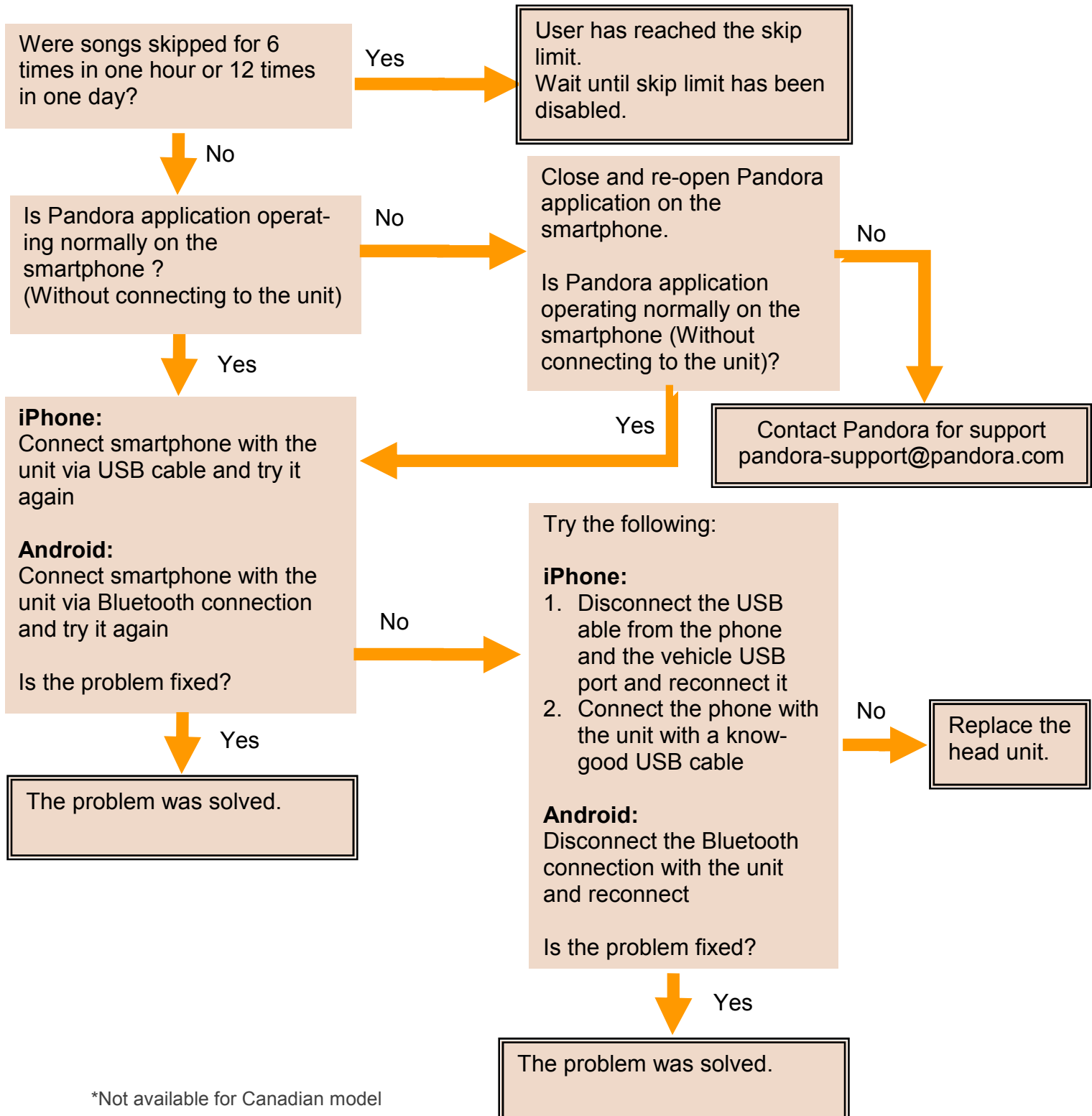

*Not available for Canadian model

2. Troubleshooting

*Pandora RADIO - Caution Message

Caution Message:

Your ratings information was not able to be saved.

Rating information (Thumb Up/Down) may not be saved to the Pandora Server.

Is Pandora application operating normally on the smartphone?
(Without connecting to the unit)

No

Close and re-open Pandora application on the smartphone.

Is Pandora application operating normally on the smartphone (Without connecting to the unit)?

No

Yes

iPhone:
Connect smartphone with the unit via USB cable and try it again.

Android:
Connect smartphone with the unit via Bluetooth connection and try it again.

Is the problem fixed?

No

Yes

The problem was solved.

Yes

Contact Pandora for support
pandora-support@pandora.com

Try the following:

iPhone:

1. Disconnect the USB cable from the phone and the vehicle USB port and reconnect it
2. Connect the phone with the unit with a know-good USB cable

Android:

Disconnect the Bluetooth connection with the unit and reconnect

Is the problem fixed?

No

Replace the head unit.

Yes

The problem was solved.

*Not available for Canadian model

2. Troubleshooting

*Pandora RADIO - Caution Message

Caution Message:

Bookmark not saved.

Bookmark information may not be saved to the Pandora Server.

Is Pandora application operating normally on the smartphone?
(Without connecting to the unit)

No

Close and re-open Pandora application on the smartphone.

Is Pandora application operating normally on the smartphone (Without connecting to the unit)?

No

Contact Pandora for support
pandora-support@pandora.com

Yes

iPhone:
Connect smartphone with the unit via USB cable and try it again.

Android:
Connect smartphone with the unit via Bluetooth connection and try it again.

Is the problem fixed?

No

Try the following:

iPhone:

1. Disconnect the USB cable from the phone and the vehicle USB port and reconnect it
2. Connect the phone with the unit with a know-good USB cable.

No

Replace the head unit.

Yes

The problem was solved.

Android:

Disconnect the Bluetooth connection with the unit and reconnect.

Is the problem fixed?

Yes

The problem was solved.

*Not available for Canadian model

2. Troubleshooting

*Pandora RADIO - Caution Message

Caution Message:

Waiting for service...

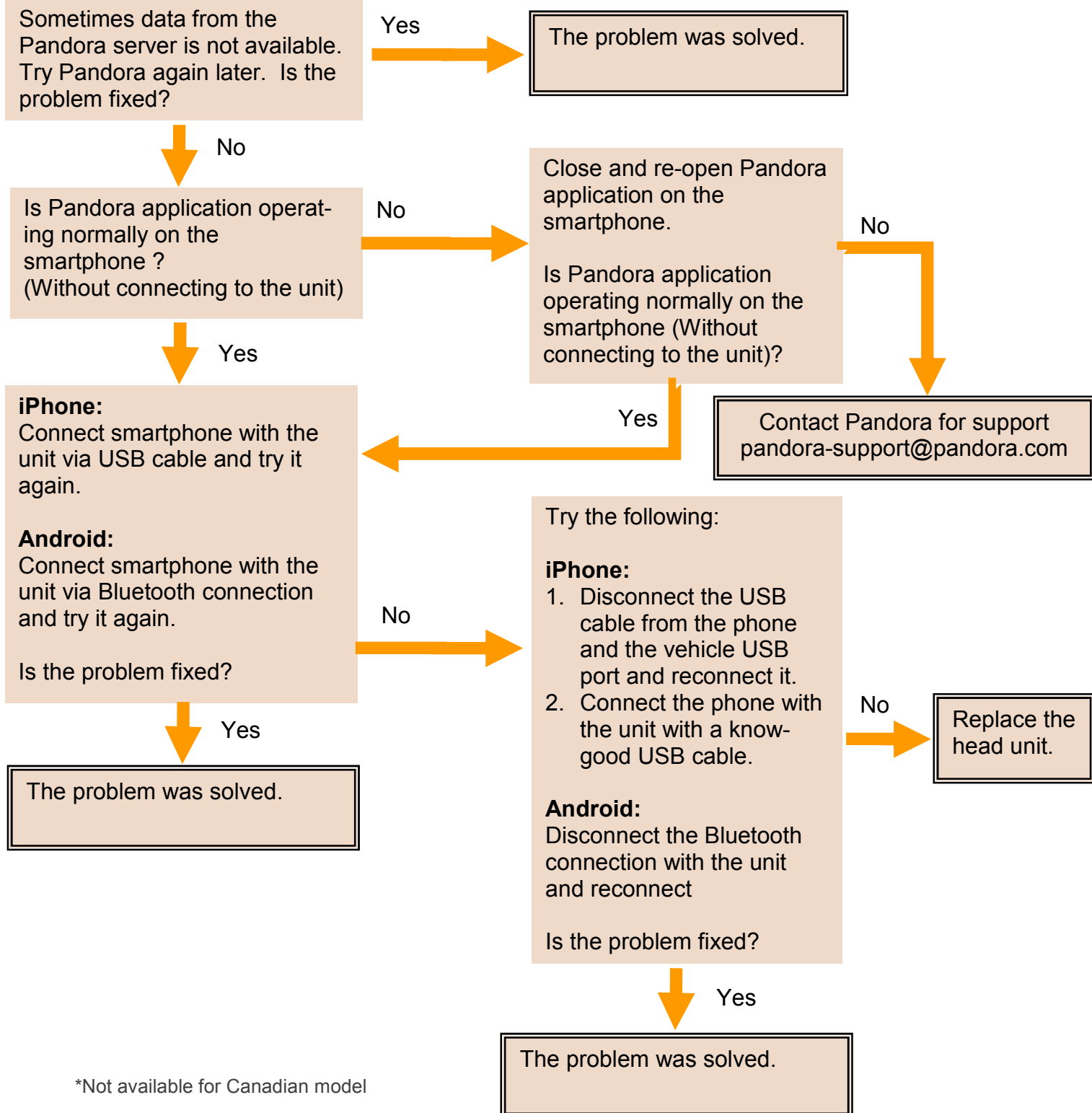

*Not available for Canadian model

2. Troubleshooting

*Pandora RADIO - Caution Message

Caution Message:

Pandora is not available at your current location.

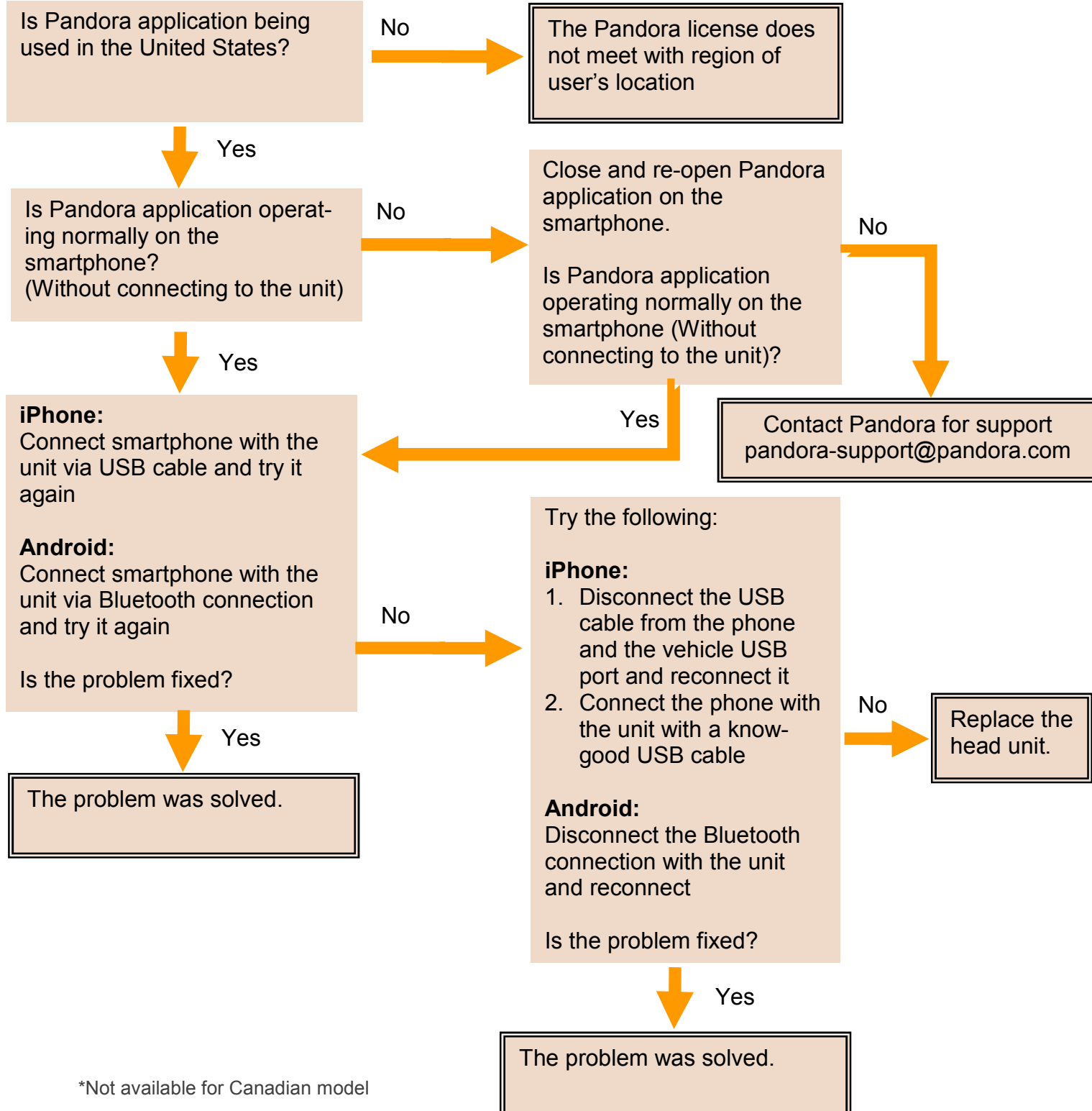

*Not available for Canadian model

2. Troubleshooting

*Pandora RADIO - Caution Message

Caution Message:

Failed to log into user's account. Please check your login username and password on your mobile device.

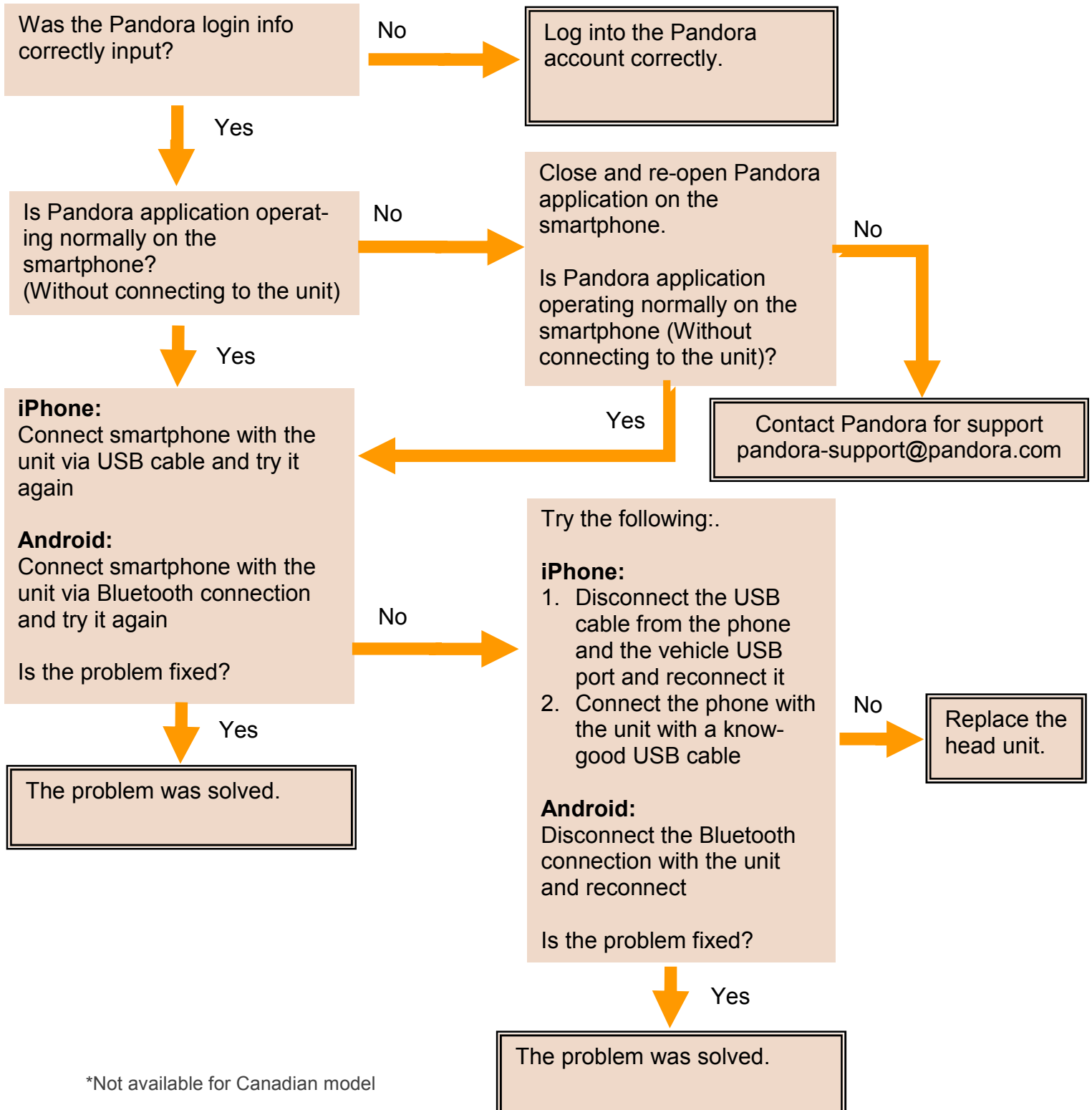

*Not available for Canadian model

2. Troubleshooting

*Pandora RADIO - Caution Message

Caution Message:

The selected Pandora station is no longer available.

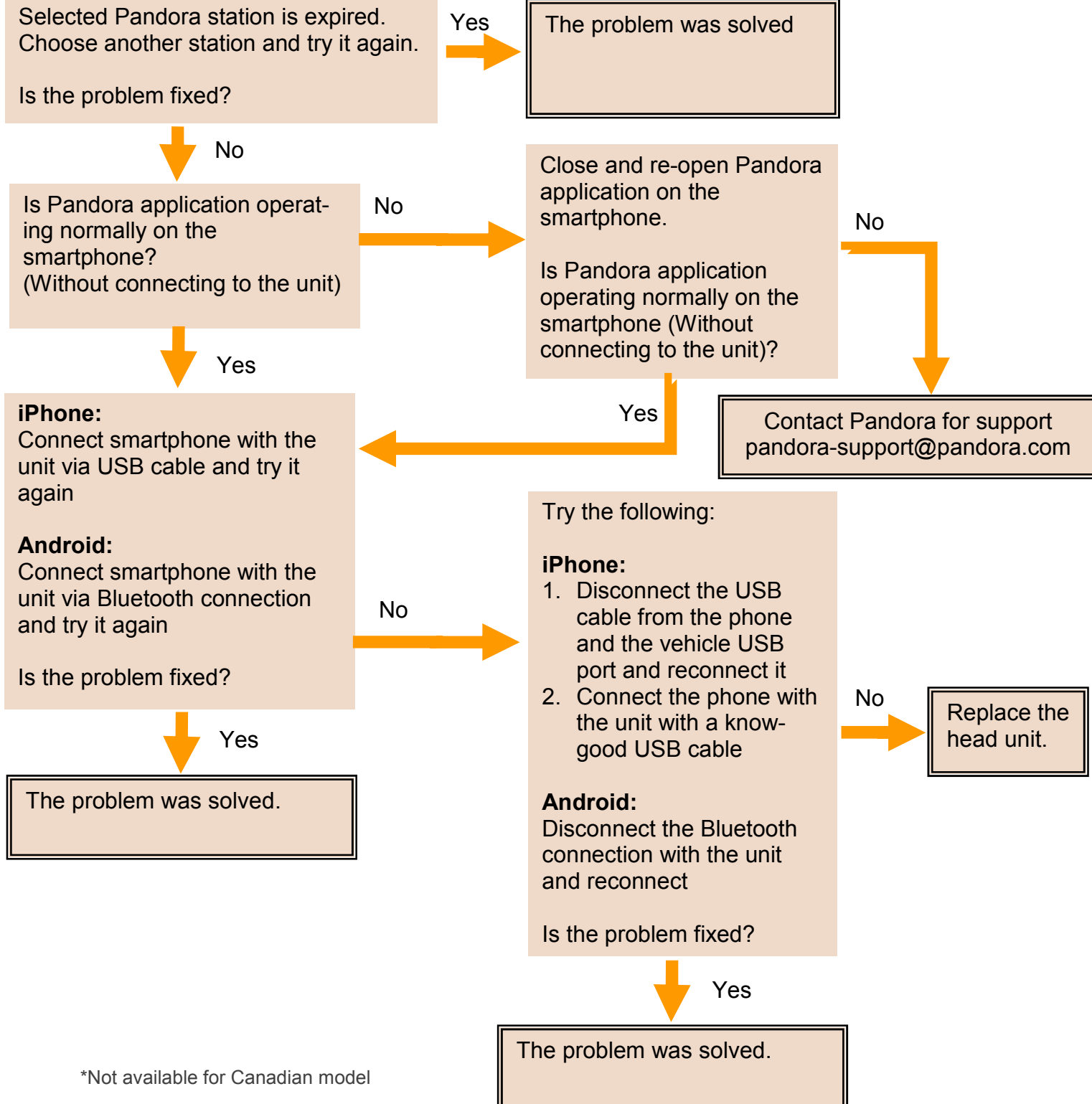

*Not available for Canadian model

2. Troubleshooting

*Pandora RADIO - Caution Message

Caution Message:

Pandora Error.

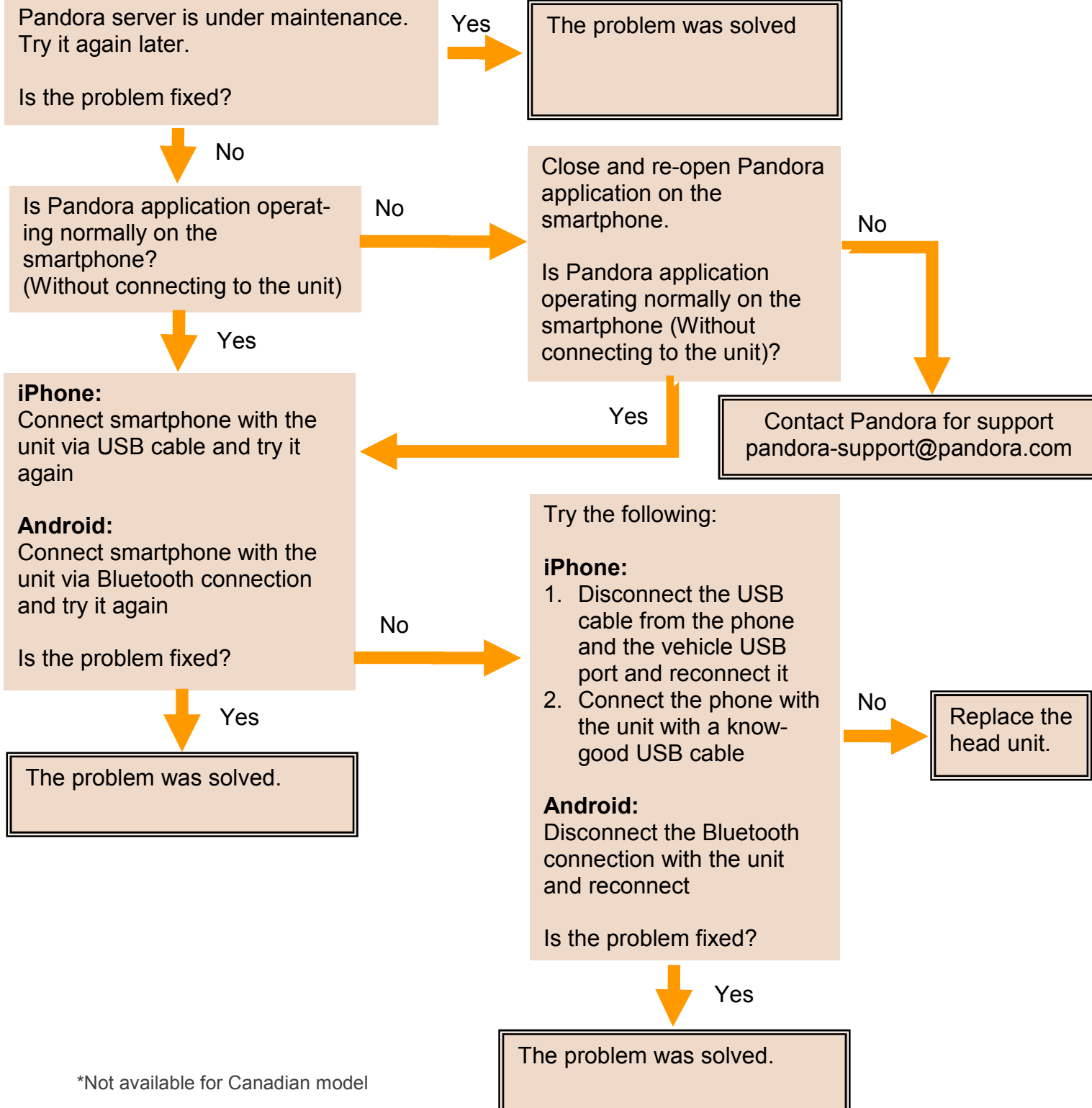

*Not available for Canadian model

2. Troubleshooting

DCM

Conditions: "SOS" or "I" button does not respond
Operator's voice is not heard
Operator cannot hear driver's voice

STARLINK Telematics does not work



"SOS" (red) and "I" (blue) buttons

Is DTC for DCM detected by using Subaru Select Monitor?

Yes

Troubleshoot using Subaru Service Manual



"Telematics Service in Progress" Screen

No

Does the display change to "Telematics Service in Progress" screen?

No

Disconnect the "F" connector from the unit and touch Pin 8 on the unit to GND. Does the display change to "Telematics Service in Progress" screen and sound is muted?

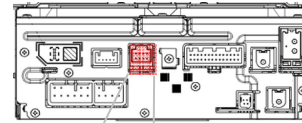

#	Pin	Descriptions
1	N.C.	Not Connected
2	N.C.	Not Connected
3	N.C.	Not Connected
4	N.C.	Not Connected
5	N.C.	Not Connected
6	N.C.	Not Connected
7	N.C.	Not Connected
8	MUTE IN	DCM

No

Replace the head unit

Yes

Troubleshoot DCM system using Subaru Service Manual

Is operator's voice heard normally?

No

Check speakers and AMP (if equipped) and connection between the head unit and speakers

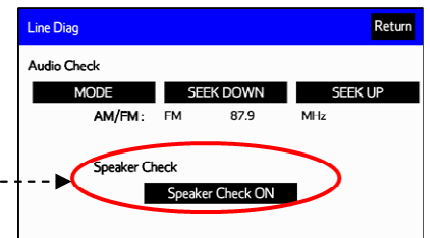

Refer to Subaru Service Manual for details

Yes

Is an operator able to hear driver's voice?

No

Check microphone and connection between the head unit and microphone

The head unit is good

Yes

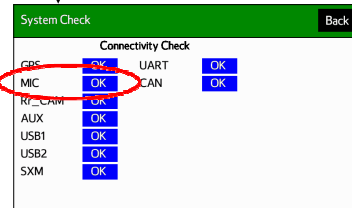
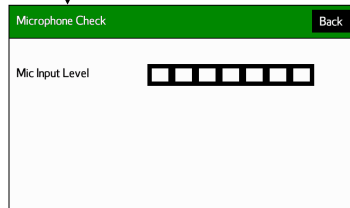

Refer to Subaru Service Manual for details

2. Troubleshooting

Siri is not enabled

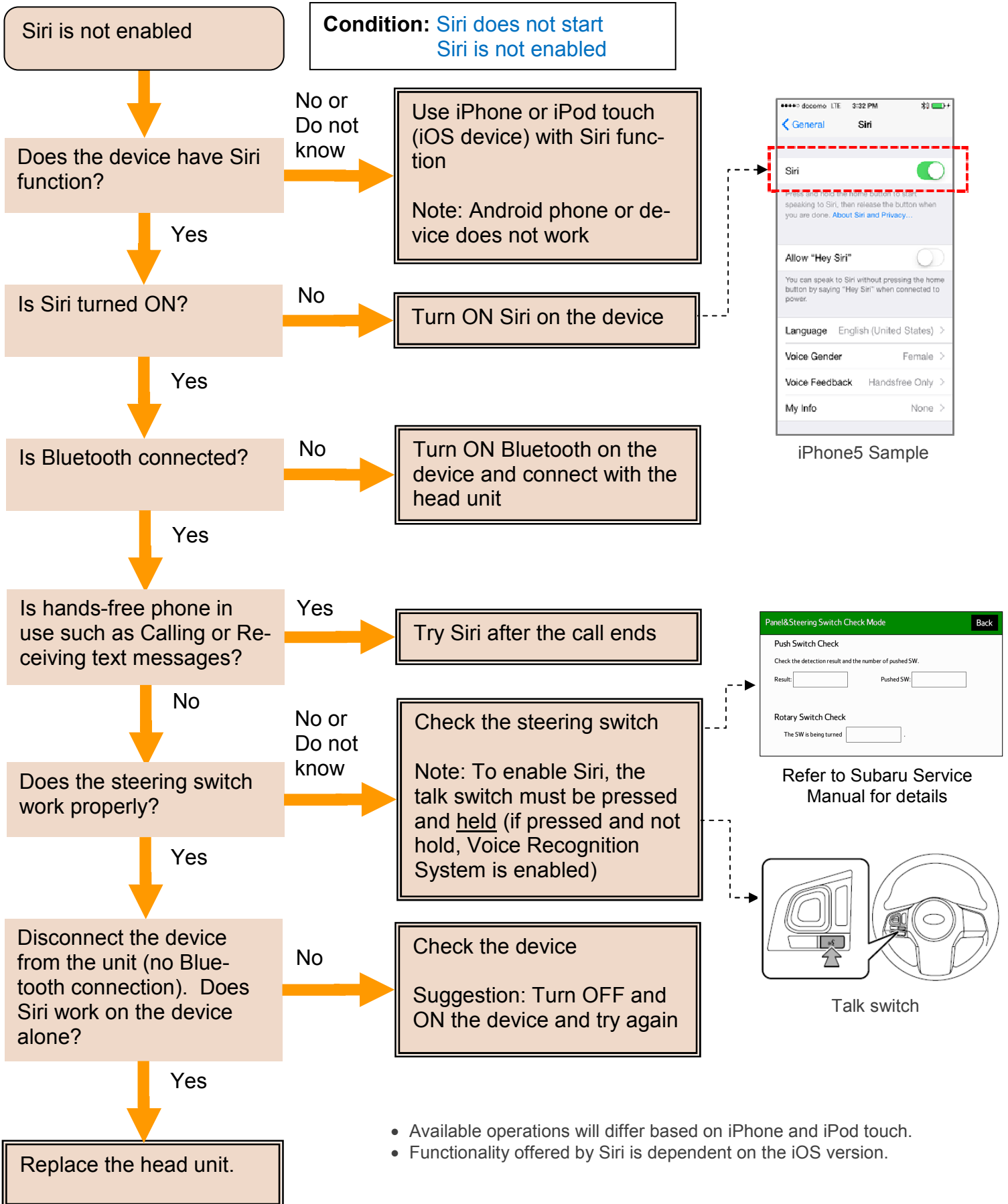

2. Troubleshooting

Siri does not recognize voice commands

Condition: Siri is enabled but does not recognize voice commands

Siri does not recognize voice commands

Does the microphone work properly?

No or Do not know

Check the microphone

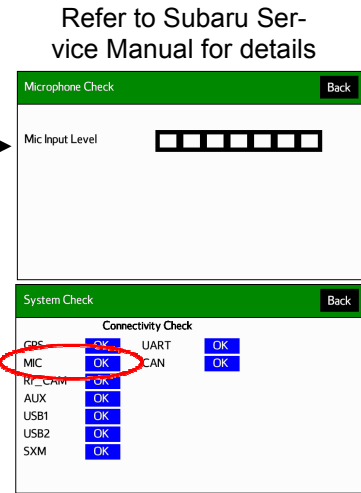

Refer to Subaru Service Manual for details

Do you use the same language on the Siri language setting?

No

Change Siri language setting on the device

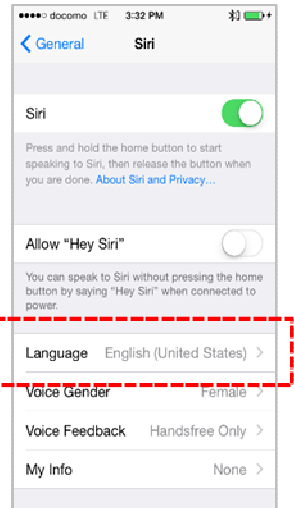

Is Siri ready to use?

No or Do not know

Press the Siri icon on the display of the head unit and try again

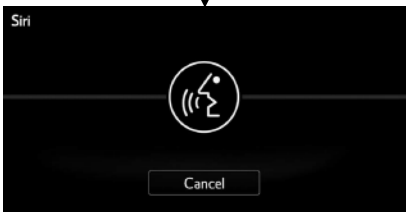

Siri Screen

Disconnect the device from the unit (no Bluetooth connection). Does Siri work on the device alone?

No

Check the device
Suggestion: Turn OFF and ON the device and try again

Replace the head unit.

- Available operations will differ based on iPhone and iPod touch.
- Functionality offered by Siri is dependent on the iOS version.

2. Troubleshooting

Unable to hear Siri's voice

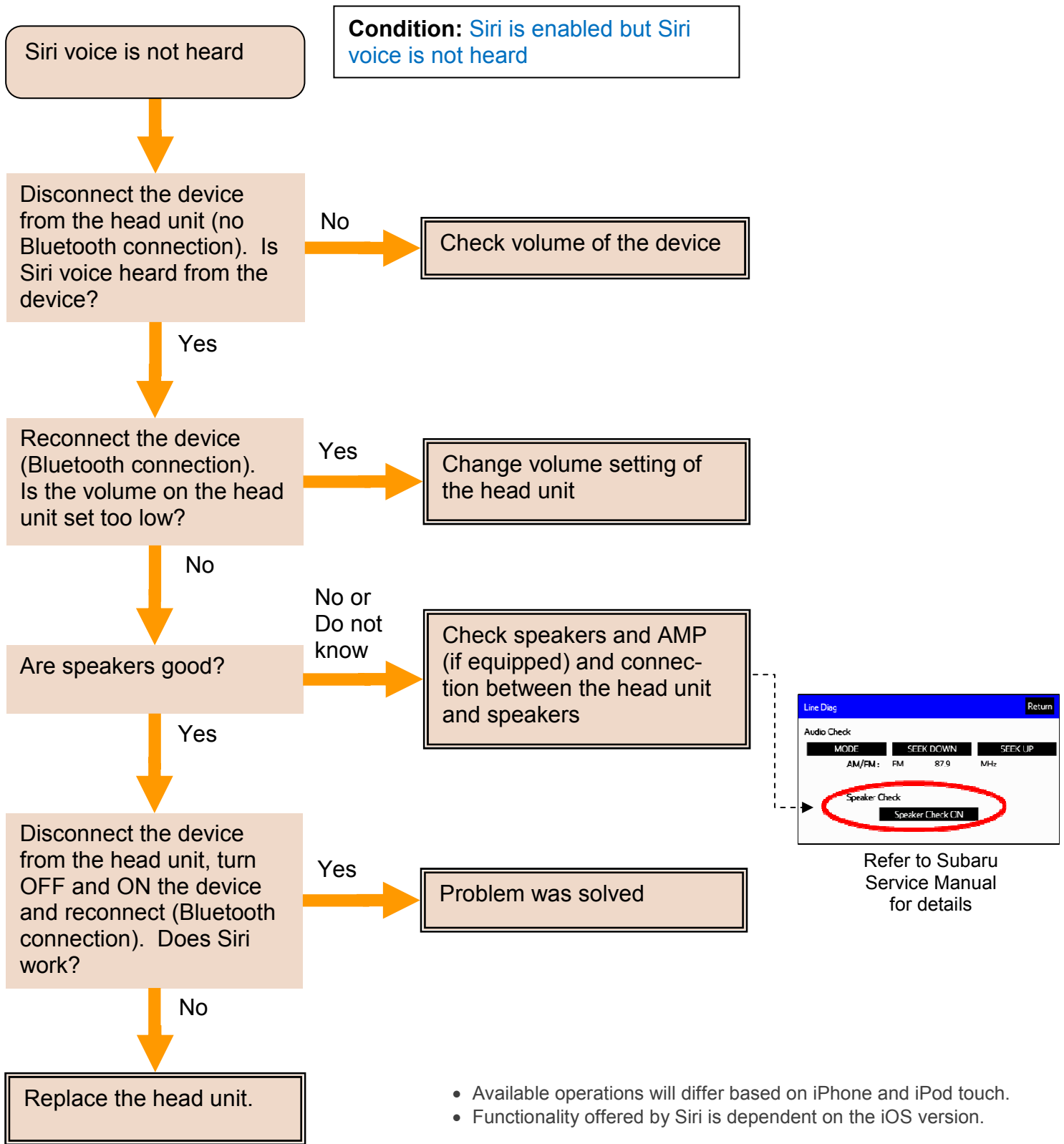

3. Frequently Asked Questions (FAQ)

Navigation

Q1	Is it possible to change the Navigation Voice Guidance from male to female?
A1	Yes, this can be changed in Voice Language Setting. (Gen 2.0 - OM P230 / Gen 2.1 - OM P241)
Q2	Can I replace the Map SD from another unit and will the Navigation work properly?
A2	Yes.
Q3	How can I register my HOME to the unit?
A3	Select MAP=>Menu=>Destination=>Go Home=>Yes=> Enter your home address=>Go (Gen 2.0 - OM P27 / Gen 2.1 - OM P29)
Q4	How can I set my HOME as a destination?
A4	Select MAP=>Menu=>Destination=>Go Home=>Next=>Go (Gen 2.0 - OM P30 / Gen 2.1 - OM P32)
Q5	How can I adjust the Navigation Voice Guidance Volume?
A5	<ul style="list-style-type: none">• When the Navigation Voice Guidance is giving a voice prompt, you can adjust the volume by turning the POWER/VOLUME knob on the unit.• Select MAP=>Menu. There are Guidance Volume setting buttons on the lower right of the Menu screen. (Gen 2.0 - OM P192 / Gen 2.1 - OM P203)• Select HOME=>SETTINGS=>Voice => Set the desired volume.• (Gen 2.0 - OM P184 / Gen 2.1 - OM P194)
Q6	Does the Route Guidance consider traffic conditions when driving to a destination?
A6	Yes. The unit will update the driver with traffic conditions and will provide the "Detour" option to avoid the traffic if selected. (Gen 2.0 - OM P231 / Gen 2.1 - OM P242)
Q7	The unit says "traffic ahead". How can I see a traffic summary of the conditions ahead?
A7	To view the traffic on your route, select the "Menu" button on the map screen and then select the Traffic icon on the lower left of the screen to show a traffic summary. (Gen 2.0 - OM P192 / Gen 2.1 - OM P203)
Q8	How do I change the Voice Guidance Voice/Language?
A8	Select MAP=>Menu=>More=>Settings=>Sounds and Warning=>Voice Language Please be aware, to be able to give Navigation Voice Commands to the unit, you must have the TTS (Text To Speech) voice selected. (Gen 2.0 - OM P229 / Gen 2.1 - OM P241)

3. Frequently Asked Questions (FAQ)

Navigation

Q9	Navigation Voice Guidance will not read street names. Why?
A9	TTS (Text To Speech) voice language is not selected in Voice Language setting.

Q10	How can I remove and insert the Map SD card?
-----	--

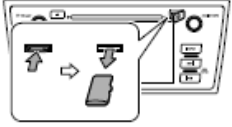
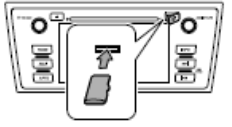
A10	<p>Remove: Turn the ignition to OFF. Open the SD card slot cover, Press in the SD card until you hear it “click”, let go off the card and then pull it straight out.</p>  <p>Insert: Turn the ignition to OFF. Open the SD card slot cover, Insert the SD card, making sure it is fully inserted. (Gen 2.0 - OM P38 / Gen 2.1 - OM P42)</p>  <p>Caution:</p> <ul style="list-style-type: none">• Do not touch terminals of the SD card to avoid contaminating them. It may cause readout failure of the SD card• Do not insert something other than the SD card. It may damage the SD card slot.• Face up the side with ▲ of the SD card when inserting it into the SD card slot• Don't forcefully push the SD card once it hits the stopper in the SD card slot
-----	---

Q11	Can the unit play music or video if I put audio/video files to the Map SD card?
-----	---

A11	No. You need to use a different SD card for music/video playback. (Gen 2.0 - OM P81 / Gen 2.1 - OM P87)
-----	--

Q12	"Unable to read the map SD data. Check the map SD. If necessary, consult your dealer" is shown on screen. Why?
-----	--

A12	Map SD card is not inserted, the SD card that is inserted does not contain map data or map data is corrupted. (Gen 2.1 - OM P19 / Gen 2.1 - OM P21)
-----	---

3. Frequently Asked Questions (FAQ)

Bluetooth Hands-Free

Q1	Can more than one phone be registered to the unit and be used at the same time?
A1	Up to 5 phones can be registered to unit, but only one phone can be used at the time. (Gen 2.0 - OM P172 / Gen 2.1 - OM P180)
Q2	How can I register a phone to the unit?
A2	<ol style="list-style-type: none">1. Turn ON the Bluetooth connection setting of your cellular phone2. Press "Phone" button for Display Audio model (Non Navigation). Press Home => Phone for Navigation model3. Select "Yes" to register the phone4. Search for "Subaru BT" in the your phone's Bluetooth menu and select it5. Select OK after the connection status changes from "Connection waiting" to "Connected" (Gen 2.0 - OM P166 / Gen 2.1 - OM P174)
Q3	Why does the receiving caller hear wind noise?
A3	This could be caused by the center air vents pointed upward toward the microphone. The microphone is located on the map light area. Lower the air vents to prevent the noise. (Gen 2.0 - OM P108 / Gen 2.1 - OM P116)
Q4	What does "Transmit Volume Setting" adjust?
A4	Transmit Volume adjusts the out going call volume of the Bluetooth hands free system. (Gen 2.0 - OM P118 / Gen 2.1 - OM P126)
Q5	How come phone calls drop when the phone is connected to Bluetooth?
A5	If the problem is intermittent, this could be a problem with the phone. Please make a few test phone calls with the cell phone not connected to the Bluetooth system to verify if there are no issues with the phone itself.
Q6	Why is the Bluetooth sound quality poor (Echo)?
A6	If the problem is intermittent, this could be a problem with the phone. Please make a few test phone calls with the cell phone not connected to the Bluetooth system to verify there are no issues with the phone itself.
Q7	How many Bluetooth devices can be registered to the head unit?
A7	Up to 5 devices can be registered to the head unit. (Gen 2.0 - OM P172 / Gen 2.1 - OM P180)
Q8	Where is the incoming voice heard from in the vehicle?
A8	Both front speakers. (Gen 2.0 - OM P107 / Gen 2.1 - OM P115)

3. Frequently Asked Questions (FAQ)

Bluetooth Hands-Free

Q9	How many "Call History" (missed, incoming and outgoing) can be displayed on the Phone screen of the unit?
A9	Up to 30. (Gen 2.0 - OM P112 / Gen 2.1 - OM P120)
Q10	How many phone contacts can be registered?
A10	Up to 2500 contacts with a maximum of 4 phone numbers and e-mail address per contact. (Gen 2.0 - OM P113 / Gen 2.1 - OM P121)
Q11	What Bluetooth profiles are required to transfer phone contacts to the unit?
A11	PBAP (Phonebook Access Profile) or OPP (Object Push Profile) (Gen 2.0 - OM P169 / Gen 2.1 - OM P178)
Q12	How many Speed Dial can be registered to the unit?
A12	Up to 15 contacts. (maximum of 4 numbers per contact) (Gen 2.0 - OM P132 / Gen 2.1 - OM P140)
Q13	Where can I find approved phones that work with the unit?
A13	http://www.subaru.com/owners/index.html

3. Frequently Asked Questions (FAQ)

Audio & Visual

Q1	Does the unit display cover art image when listening to Sirius XM radio?
A1	No for Gen 2.0. Yes for 2.1, but depending on the channel
Q2	Does the unit display the Sirius XM signal strength?
A2	No.
Q3	Can I watch video/slideshow from USB flash memory or SD card while driving?
A3	No. You will only hear the audio from the video files while driving. (Gen 2.0 - OM P71 / Gen 2.1 - MO P81)
Q4	How do I mute the audio?
A4	<ul style="list-style-type: none">• Press the "POWER/VOLUME" button to turn audio off (Gen 2.0 - OM P19 / Gen 2.1 - OM P21)• Press the "Mute" on steering switches. (Gen 2.0 - OM P87 / Gen 2.1 - OM P96)
Q5	How do I turn the screen off?
A5	<ul style="list-style-type: none">• Press and hold the "POWER/VOLUME" button.• Press Home=>Settings=>Screen Off (Gen 2.0 - OM P26 / Gen 2.1 - OM P28)
Q6	Can I view pictures on the unit from USB Flash Memory and the SD card?
A6	Yes. (Gen 2.0 - OM P74, 81 / Gen 2.1 - OM P81, 84) Pictures need to be in JPG or JPEG format.
Q7	How do I change the display from full screen to split screen?
A7	Press and hold the "AUDIO/TUNE" knob. (Gen 2.0 - OM P43 / Gen 2.1 - OM P47)
Q8	Can I set the unit to change to split screen automatically?
A8	Yes. Press Home=> Settings=>General=>Auto Change to Split Screen (Gen 2.0 - OM P179 / Gen 2.1 - OM P189)
Q9	Why is the cover art not displayed when on Sirius XM mode?
A9	Gen 2.0 - Sirius XM mode does not support displaying the cover art. Gen 2.1 - SXM does display Album Cover Art (Depending on the station) . Station Logos will also be displayed.
Q10	Can the unit accept more than one disc?
A10	No. The unit is a single disc player.
Q11	Which audio mode supports a "Tag" function?
A11	HD Radio and Sirius XM Radio modes

3. Frequently Asked Questions (FAQ)

Audio & Visual

Q12	Why can I not download my Tagged songs onto my USB/Phone?
A12	Tagged songs can only be downloaded to iPod/ iPhones. (Gen 2.0 - OM P62 / Gen 2.1 - OM P66)
Q13	Can the unit play a picture slideshow from the USB Flash Memory?
A13	Yes. The slideshow can be displayed from the USB memory or the SD Card. Photo files must be JPG or JPEG only. (Gen 2.0 - OM P71 / Gen 2.1 - OM P81)
Q14	Can I replace the opening screen with my own picture?
A14	No. The opening screen cannot be replaced or customized.
Q15	Can I play DVD/Blu-ray movies?
A15	No. The system does not support DVD or Blu-ray playback.
Q16	How can I find the XM Radio ID number?
A16	Tune to channel 000 for the Radio ID number. (Gen 2.0 - OM P68 / Gen 2.1 - OM P73)
Q17	Why will my iPhone not play apps (Pandora/aha)?
A17	When using an iPhone to access aha or Pandora, a USB cable connection is needed from the iPhone to the Unit. (Gen 2.0 - OM P142, 150 / Gen 2.1 - OM P152, 158)
Q18	Can I listen to music or watch videos when I put music and/or movie files to my SD card?
A18	Yes. But you cannot watch a movie while driving. (Gen 2.0 - OM P78 / Gen 2.1 - OM P87)
Q19	Can I reorder the audio sources on the Audio Source page?
A19	Yes. (Gen 2.0 - OM P51 / Gen 2.1 - OM P55)
Q20	How many Tags can be stored to the unit?
A20	50. (Gen 2.0 - OM P62 / Gen 2.1 - OM P66)
Q21	What is Tag function?
A21	The user can "Tag" songs they would be interested in purchasing later on. When an iPod is connected to the unit, the "Tags" are transferred to the iPod and when the iPod is connected to a computer with iTunes, the "Tags" suggest songs for the user to purchase. (Gen 2.0 - OM P62 / Gen 2.1 - OM P67)

3. Frequently Asked Questions (FAQ)

Audio & Visual

Q22	While listening to HD Radio, sometimes I see Album Art, but sometimes I do not, Why?
A22	You can see Album Art only when the HD radio station broadcasts album image data. (Gen 2.0 - OM P63 / Gen 2.1 - OM P67)
Q23	What is the Cache Function?
A23	Gen 2.0 - The unit can record a FM/AM radio program and play it back in a time shifted manner (20 minutes max recording capacity). (OM P63) Gen 2.1 - The unit can record a SXM or FM/AM Radio program and play it back in a time shifted manner. Any SXM, AM, or FM Radio program you are currently listening to, will be cached (OM P67,74)
Q24	How long can Cache radio function store audio data?
A24	Gen 2.0 - 20 minutes for FM/AM (OM P63) Gen 2.1 - 20 minutes for FM/AM and anywhere from 30 to 60 minutes for SXM. Depending on the size of the content the SXM module adjusts the length of the cache accordingly (OM P67,74)
Q25	Can I watch videos from the iPod?
A25	No.
Q26	Can iPod's be charged when they are connected to the USB port?
A26	Yes.
Q27	Which iPod is supported?
A27	iPod Compatibility Chart can be found on the Owners Manual (Gen 2.0 - OM P97 / Gen 2.1 - OM P106)
Q28	Can I set an image to appear when I turn the screen off?
A28	Yes. Create a folder labeled "image" on a USB Flash Memory Device, and up to 10 Jpg or JPEG images can be added to this folder. You will then be able to copy those images to the unit. (Gen 2.0 - OM P181 / Gen 2.1 - OM P191)
Q29	Can I view picture slideshow on the unit from USB Flash Memory or the SD card?
A29	Yes. (Gen 2.0 - OM P71, 78 / Gen 2.1 - OM P81, 87) Pictures need to be in JPG or JPEG format.
Q30	Can I listen to music or watch videos when I put music and/or movie files to my USB Flash Memory or SD card?
A30	Yes. But you cannot watch a movie while driving. (Gen 2.0 - OM P71, 78 / Gen 2.1 - OM P81, 87)
Q31	Does the unit support video playback on USB Flash Memory or the SD card? If so what formats?
A31	Yes. Supported file formats are WMV, AVI, and MPEG4 (Gen 2.0 - OM P101 / Gen 2.1 - OM P 110)

3. Frequently Asked Questions (FAQ)

Audio & Visual

Q32	What functions are supported by USB Flash Memory and the SD Card?
A32	Audio/Video/Slideshow playback
Q33	What USB Flash Memory Device is supported?
A33	Communication format: USB2.0 File format: FAT16/32 Class: Mass storage class. (Gen 2.0 - OM P96 / Gen 2.1 - OM P106)
Q34	What Audio formats are supported for USB flash memory and the SD card?
A34	MP3/WMA/AAC. (Gen 2.0 - OM P98 / Gen 2.1 - OM P107)
Q35	What is the micro SD card's supported capacity?
A35	32GB. (Gen 2.0 - OM P97 / Gen 2.1 - OM P107)
Q36	What are Smart Favorites?
A36	Gen 2.1 - Smart Favorites are set up by the user. They can be up to 5 SXM presets that the user can select to cache radio programming. (OM P75)
Q37	What is Tune Start?
A37	Gen 2.1 - With Tune Start turned on, any Smart Favorite channel that is selected, will start playing audio from the beginning of the song or program that is currently playing on that station (OM P75)
Q38	What is Tune Scan?
A38	Gen 2.1 - Tune Scan is when the unit will go through all the Smart Favorite channels and play the first 10 seconds of each song or program that is cached. Not all stations have the ability to be Tune Scanned (OM P76)
Q39	What are "Featured Favorites"?
A39	Gen 2.1 - With Featured Favorites Turned on, the user will be given a Featured Favorite section in the Category list. Featured Favorites are created by SXM several times throughout the year. (OM P76)

3. Frequently Asked Questions (FAQ)

APPS

Q1	How do I connect the STARLINK App on my smart phone to the unit?
A1	Gen 2.0 - USB connection for iPhone, Bluetooth connection Android phone. Gen 2.1 - Bluetooth connection for both iPhone and Android phones (Gen 2.0 - OM P138 / Gen 2.1 - OM P149)
Q2	How do I connect the MirrorLink on my smart phone to the unit?
A2	USB connection for Android phone. (Gen 2.0 - OM P139 / Gen 2.1 - OM P150)
Q3	What are the supported devices for MirrorLink?
A3	MirrorLink compatible device information can be found on the following website: http://www.mirrorlink.com/ . Depending on differences between models and software versions, some model phones might be incompatible with this system.
Q4	What is aha?
A4	aha is a cloud-based application that connects to the system and gives you access to you favorite web content safely and easily. (Gen 2.0 - OM P142 / Gen 2.1 - OM P152)
Q5	What is Pandora?
A5	Pandora is a free personalized radio that offers effortless and endless music enjoyment and discovery. (Gen 2.0 - OM P150 / Gen 2.1 - OM P158)
Q6	What Bluetooth profile is required for APPS function?
A6	SPP (Serial Port Profile) (Gen 2.0 - OM P169 / Gen 2.1 - OM P178)
Q7	Why will my iPhone not play apps (Pandora/aha)?
A7	When using an iPhone to access aha or Pandora, a USB cable connection is needed from the iPhone to the Unit. (Gen 2.0 - OM P142, 150 / Gen 2.1 - OM P152, 158)
Q8	Do I need to install aha/Pandora/Starlink/Mirrorlink applications to my smart phone to use these functions?
A8	Yes. (Gen 2.0 - OM P137 / Gen 2.1 - OM P147)
Q9	How do I connect my smartphone with the unit for the aha/Pandora function?
A9	iPhone for USB connection. Android phone for Bluetooth connection (OM P142, 150 / Gen 2.1 OM - P152, 158)
Q10	I have 55 aha preset stations on my phone. Can the system display all 55 preset stations?
A10	No. The system displays the top 35 stations. (Gen 2.0 - OM P143, 144 / Gen 2.1 - OM P153, 154)

3. Frequently Asked Questions (FAQ)

APPS

Q11	Where can I find the aha/Pandora app to install on my smartphone?
A11	iPhone: Apple App Store. Android device: Google Play Store. (Gen 2.0 - OM P145 / Gen 2.1 - OM P147)
Q12	What wireless network is required for aha, Pandora, STARLINK and MirrorLink?
A12	3G, 4G, Wi-Fi or 4G LTE. (Gen 2.0 - OM P145 / Gen 2.1 - OM P147)
Q13	What are the supported devices for aha/Pandora?
A13	iPhone: iOS 5.0 or later. Android: Android 2.2 or later. (Gen 2.0 - OM P146, 151 / Gen 2.1 - OM P154, 160)

3. Frequently Asked Questions (FAQ)

INFO

Q1	Will the Weather Information update automatically based on my location?
A1	Yes for Navigation model. No for Display Audio model (Non-Navigation) Select the location manually (Gen 2.0 - OM P155 / Gen 2.1 - OM P163)
Q2	What information is provided by Sirius XM Radio Data Service?
A2	Weather, Stocks, Sports, Fuel and Traffic (Gen 2.0 - OM P154 / Gen 2.1 - OM P162)
Q3	Does Sirius XM Radio Data Service cover Canada?
A3	Gen 2.0 - No Gen 2.1 - Yes, except for fuel services
Q4	Do I need a paid subscription to receive Sirius XM Satellite Radio Data Service?
A4	Yes (Gen 2.0 - OM P154 / Gen 2.1 - OM P162)

3. Frequently Asked Questions (FAQ)

Voice Recognitions & Others

Q1	How do I find a list of voice commands to use with the system?
A1	The information can be found from Owner's Manual (Gen 2.0 - OM P245 / Gen 2.1 - OM P261)
Q2	How come I cannot give Navigation Voice Commands to the system?
A2	Navigation Voice Commands can only be given to the system when using the TTS (Text To Speech) voice for the Navigation (Gen 2.0 - OM P35 / Gen 2.1 - OM P39)
Q3	What data can be deleted by pressing "Delete Personal Data"?
A3	General settings, Navigation Settings, Audio settings, Sirius XM Radio settings, Sirius XM Radio service contents and Phone settings (Gen 2.0 - OM P183 / Gen 2.1 - OM P193)
Q4	What is the "Maintenance" function in Information screen?
A4	The system reminds users when to replace certain parts or components and shows dealer information on the screen (Gen 2.0 - OM P186 / Gen 2.1 OM P196)
Q5	On Messaging function does the system display photos with text message?
A5	No. The unit can only display Text when the vehicle is stopped.
Q6	Does the system support Bluetooth Message function?
A6	Yes (Gen 2.0 - OM P119 / Gen 2.1 - OM P127)
Q7	Can I view the received text message on the unit while driving?
A7	No. (Gen 2.0 - OM P122 / Gen 2.1 - OM P130)
Q8	Why won't the system show notifications when using 3rd party messaging apps?
A8	The system can not support 3rd party messaging apps. Please use the original phone messaging app.
Q9	How many "Quick Reply Message " are stored in the unit?
A9	15 (Gen 2.0 - OM P122 / Gen 2.1 - OM P130)

3. Frequently Asked Questions (FAQ)

Voice Recognitions & Others

Q10	Why will my iPhone not show incoming text messages?
A10	<p>Follow the steps below to receive messages on the iPhone.</p> <ol style="list-style-type: none">1. Pair the Phone to the unit.2. On the phone screen press the envelope on the top right of the screen3. Select yes, you want to setup messaging. 4. On the phone select settings5. On the phone select Bluetooth6. On the Bluetooth page, select the Information “I” next to the Subaru system7. On the information page, turn on “Show Notifications” <p>Now when a text message comes in on the iPhone, and it is connected to the unit, it will display the message on screen. If messages do not show up right away. Turn the ACC off and back on and let the phone automatically reconnect to the system.</p>
Q11	Why will my Voice Recognition not understand any of my commands?
A11	<p>Voice Commands may not be recognized if:</p> <ul style="list-style-type: none">• Spoken too quickly.• Spoken at a low or high volume.• Driving with the window open.• Passengers are talking while voice commands are spoken.• The air conditioning speed is set to high.• Air vents are pointed upward and blowing air over the microphone.
Q12	How can I use Siri?
A12	<p>Gen 2.1 - Customer must have a Siri supported Apple iPhone product connected via Bluetooth to the head unit. Press and hold the VR button on the steering wheel until the Siri screen shows on the head unit (OM P252)</p>
Q13	What Commands can I give Siri?
A13	<p>Gen 2.1 - Phone Commands – “Dial, Call....” Text Commands – “Text John I will be running late...” Call local establishments – “Find the closest Chinese restaurant” Check the weather - “What is the Forecast?” Take Notes - “Make a Note, Sign up for the Gym this week” Create Reminders - “Remind me to pick up flowers for my wife at 4PM” The iPhone will restrict some commands when driving. Not all commands will work when connected to the vehicle.</p>
Q14	Why won't Siri put directions on the vehicle's map screen?
A14	<p>Gen 2.1 - Siri is not able to transfer direction to the vehicle's navigation system</p>

3. Frequently Asked Questions (FAQ)

STARLINK (General)

A-Q1	What is STARLINK?
A-A1	The STARLINK system puts news, food, weather, music, podcasts, audiobooks, and other multimedia content into your vehicle and at your fingertips.
A-Q2	How can I use "STARLINK"? Can I use STARLINK by only connecting Smartphone to the head unit?
A-A2	Install "STARLINK App" to your smartphone from "Apple Store" or "Google Play". Open "STARLINK App" on your smartphone. Refer to the following procedure. [Procedure] 1) Connect your smartphone with the head unit (Gen 2.0: USB for iPhone, Bluetooth for Android. Gen 2.1: Bluetooth for both iPhone and Android) 2) Press APP button of the head unit. 3) Click STARLINK icon on the display. 4) If App icons are displayed on the display, the connection has been successfully established. *Regarding how to connect with Bluetooth, please refer to the manual for your smartphone.
A-Q3	How long can smartphone run by using STARLINK without charging the phone battery?
A-A3	Battery consumption depends on your smartphone and connection method.
A-Q4	Do I need any subscription to be updated when head unit or smartphone was replaced?
A-A4	No.
A-Q5	Is it possible to use STARLINK without Bluetooth?
A-A5	No for Gen 2.0 with Android phone and Gen 2.1 for both iPhone and Android phone.
A-Q6	Is it possible to connect to STARLINK 7 days a week 24 hours a day?
A-A6	Yes.
A-Q7	Do I need to pay to download STARLINK App?
A-A7	No. It's free.
A-Q8	Which has better sound quality when listening to music, STARLINK or CD?
A-A8	Sound quality depends on CD or music data on your smartphone. (STARLINK compress music data when it's streaming. Music on CD is not compressed.)
A-Q9	Can I link my email or other smartphone apps to STARLINK?
A-A9	No.

3. Frequently Asked Questions (FAQ)

STARLINK (General)

A-Q10	Does STARLINK increase data usage?
A-A10	Yes. STARLINK increase data usage on your smartphone. Usage depends on how you use. 1) News: Downloading text - a few kilobytes per article 2) Calendar: Downloading schedule - a few kilobytes per schedule 3) Weather: a few kilobytes per minute 4) Music: a few kilobytes at startup 5) iHeart: 10-15 megabytes per 30 minutes
A-Q11	Do I need smartphone to use STARLINK?
A-A11	Yes. STARLINK connects to internet and cloud service via Smartphone.
A-Q12	Are there any trouble shooting guides available if STARLINK, Mirrorlink, or Aha does not work?
A-A12	Trouble shootings for STARLINK, and Aha are available on the owners manual.
A-Q13	What Apps does STARLINK offer? Will STARLINK offer more Apps in the future?
A-A13	Gen 2.0: News, Music, Weather, iHeart Radio, and Calendar Gen 2.1: News, Music, Weather, iHeart Radio, Calendar and Stitcher More Apps will be available in future.
A-Q14	How will the customer know when new Apps are available for STARLINK?
A-A14	New Apps will be added to the Home screen as soon as they become available.
A-Q15	What will happen when a phone call is received while listening to music through STARLINK?
A-A15	A phone call has priority. STARLINK Apps will be temporary paused when a phone call is received.
A-Q16	Is it possible to use STARLINK via tablet with 3G/4G connection?
A-A16	Yes.
A-Q17	Are there any instructions available on the STARLINK web site?
A-A17	No. Instructions are currently not available on the web site.
A-Q18	Is there any way to confirm if the communication is successful or not?
A-A18	Communication is successful when the globe icon on the upper right corner is blue.

3. Frequently Asked Questions (FAQ)

STARLINK (General)

A-Q19	Is there any way to confirm the version of STARLINK App?
A-A19	Version of STARLINK can be confirmed on your smartphone. [iPhone] 1) Go to Setting 2) Click General 3) Click Usage 4) Select STARLINK under STORAGE [Android] 1) Go to Setting 2) Go to Application Manager 3) Select STARLINK
A-Q20	What kind of wireless communications with my smartphone is required to use STARLINK? (ex. Wi-Fi, 3G, 4G, 4G LTE?)
A-A20	Any wireless communications work.
A-Q21	Will Apps on the head unit be updated?
A-A21	No. Apps on the head unit won't be updated. Only Apps on your smartphone will be updated.
A-Q22	Is it possible to use other smartphone based Apps?
A-A22	No. You can't use other smartphone based Apps on STARLINK.
A-Q23	Is it possible to play music downloaded through other Apps on my smartphone?
A-A23	Yes. STARLINK can play music on your smartphone if its format is MP3 or ACC.
A-Q24	Is there any way to use STARLINK with any other phone than smartphone?
A-A24	No. STARLINK is available only for smartphones.
A-Q25	Are there any differences in STARLINK between iPhone and Android?
A-A25	No.
A-Q26	Is it possible to investigate STARLINK problem with retailer technician's smartphone instead of customer's?
A-A26	Yes.
A-Q27	Can I use STARLINK on a smartphone without connecting it to the head unit?
A-A27	No.

3. Frequently Asked Questions (FAQ)

STARLINK (General)

A-Q28	What should I do when the head unit is replaced?
A-A28	Your smartphone needs to be paired by Bluetooth again.
A-Q29	Can I move the STARLINK data from one vehicle to another?
A-A29	No.
A-Q30	When I sell my vehicle, can I delete the STARLINK Data?
A-A30	Yes. Go to General setting > Delete personal data
A-Q31	Can I operate STARLINK while I am driving?
A-A31	Operation of STARLINK Apps will be limited over 5 mph. Limitation depends on each App. Some information may be hidden on the display while driving over 5 mph.
A-Q32	What should I do when STARLINK freezes?
A-A32	Press "HOME" button to go back to Home screen.
A-Q33	STARLINK icon is active, but it won't launch by pressing the icon.
A-A33	STARLINK App must be running on your smartphone before launching STARLINK on the head unit. Make sure that STARLINK App is running on your smartphone before pressing STARLINK icon on the head unit.
A-Q34	Why are my Aha and STARLINK icons grayed out?
A-A34	There are three possible causes. 1) STARLINK App is not installed on your smartphone 2) Head unit and your smartphone are not connected 3) STARLINK App is not running on your smartphone
A-Q35	Can I use STARLINK with the steering wheel control?
A-A35	No.
A-Q36	Can I operate STARLINK with the hard buttons on the head unit?
A-A36	No.

3. Frequently Asked Questions (FAQ)

STARLINK (General)

A-Q37	What should I do if I deleted STARLINK App?
A-A37	<p>Download STRALINK App to your smartphone again.</p> <p>Clear the cache with the following procedures.</p> <ol style="list-style-type: none">1) Touch "STARLINK" on APPS2) Touch and hold the bottom right of the display for 30 seconds.3) Initialization is complete when "Select Audio Source" shows4) Run STARLINK again

3. Frequently Asked Questions (FAQ)

STARLINK (Connection)

B-Q1	Can I use multiple smartphones for STARLINK?
B-A1	Yes. Up to 5 smartphones can be registered with STARLINK. However, only one smartphone can be connected at the same time.
B-Q2	Can I use one smartphone for STARLINK on multiple vehicles?
B-A2	Yes. However, only one setting is available per smartphone. It can't have multiple settings.
B-Q3	What happens if more than one smartphones registered with STARLINK are in the same vehicle?
B-A3	The smartphone connected before ACC was turned off last time will automatically be connected. Automatic connection feature can be turned off on the SETTING.
B-Q4	What is Mirrorlink?
B-A4	Mirrorlink offers seamless connectivity between a smartphone and the head unit. Drivers just connect the phone with a cable and immediately gain access to phone applications via the head unit's screen.
B-Q5	Can I charge my iPhone with USB port while Aha is being streamed?
B-A5	Yes. However, there is a possibility of not being charged if your iPhone is overheated by using Apps.
B-Q6	What happens if I connect iPhone to USB while Bluetooth connection is established with another phone for STARLINK?
B-A6	Refer to the flowchart attached.
B-Q7	I have an Android Smartphone. Can I use STARLINK by connecting Smartphone with USB cable?
B-A7	STARLINK can be used with only Bluetooth connection. USB can be connected for charging purpose while using STARLINK over Bluetooth connection.
B-Q8	Can I use STARLINK while I am using hands-free phone?
B-A8	Yes. However, only hands-free sound can be listened.
B-Q9	Do I need customer's smartphone when I troubleshoot SATRLINK?
B-A9	It depends on the symptom. Customer's smartphone is not always necessary, but it is a good practice to test the system with the customer's smartphone.

3. Frequently Asked Questions (FAQ)

STARLINK (Connection)

B-Q10	What should I do if I get a new smartphone?
B-A10	<p>Download STRALINK App to your new smartphone. Android phone needs to be paired via Bluetooth again.</p> <p>If you still have a problem, clear the cache with the following procedures.</p> <ol style="list-style-type: none">1) Touch "STARLINK" on APPS2) Touch and hold the bottom right of the display for 30 seconds.3) Initialization is complete when "Select Audio Source" shows4) Run the STARLINK again.
B-Q11	The launcher screen of STARLINK is not displayed properly.
B-A11	Push right bottom of screen for more than 30 seconds then release. Switch to Audio menu screen after release.
B-Q12	<p>Following error messages are displayed.</p> <p>"Please disconnect mobile device and install the STARLINK application on your mobile device and try again."</p> <p>"Bluetooth disconnected, please reconnect and try again."</p> <p>"Smartphone data connection is poor, please try to connect again."</p>
B-A12	<p>Download STARLINK App to your smartphone again.</p> <ol style="list-style-type: none">1) Go to "HOME" > "SETTING" > "Bluetooth"2) Select connected device3) Select "Disconnect All"4) After disconnecting your device, select "Connect All"
B-Q13	Do I need to download other Apps than STARLINK App?
B-A13	No.
B-Q14	How can I update STARLINK App?
B-A14	Update of STARLINK can be checked on App Store or Google Play on your smartphone.
B-Q15	Can I use STARLINK if the smartphone screen is locked?
B-A15	Yes. STARLINK can be used as long as STARLINK App is running on the smartphone even if the screen is locked.
B-Q16	Can I use STARLINK if the smartphone is turned off?
B-A16	No.
B-Q17	Region can't be added on CONFIG of the Weather App.
B-A17	Regions can be saved up to 6 regions. Delete other region before adding a new region.

3. Frequently Asked Questions (FAQ)

STARLINK (Connection)

B-Q18	Source can't be added on CONFIG of the News App.
B-A18	News sources can be added up to 6 sources. Delete other source before adding a new source.
B-Q19	Error message shows when selecting the SETTING tab.
B-A19	Data communication is failed. Move to better reception area and try again.
B-Q20	Maintenance message shows when selecting the SETTING tab.
B-A20	The server is under maintenance.
B-Q21	How can I go back to the Apps list after selecting Google login on the Calendar App?
B-A21	Select SETTING tab.
B-Q22	Who should I contact if STARLINK App is not working?
B-A22	(USA) Clarion Corporation of America Mr. Don Starnes <dsstarnes@clarionus.com> c.c. Mr. Gilbert Carter <gcarter@clarionus.com> Mr. Nobuyuki Yoshizawa <nyoshizawa@clarionus.com> (CANADA) Clarion Canada Inc. Mr. Kee Chang <kchang@clarioncanada.com>
B-Q23	"Search failed" shows when registering URL on the News App.
B-A23	Check if the URL is correct.

3. Frequently Asked Questions (FAQ)

STARLINK (Apps - Calendar)

C-Q1	How do I sync Google calendar with STARLINK?
C-A1	1) Run STARLINK App on your smartphone 2) Go to "SETTING" 3) Go to "Calendar" 4) Go to "CONFIG" (upper right corner) 5) Go to "Google Login" and log in to your Google account
C-Q2	"Reconnect after logging in from your smartphone"
C-A2	Go to "SETTING" > "Calendar" > "CONFIG" Log in to your calendar
C-Q3	I can't enter schedule.
C-A3	Calendar App does not have a function to enter schedule. Enter schedule on your smartphone or PC.
C-Q4	"???" in Calendar.
C-A4	Font is not supported by the head unit.
C-Q5	"Update failed. Update again?"
C-A5	No internet connection. Check your internet connection.
C-Q6	No information on the calendar.
C-A6	No communication with the server. Check if the globe icon is blue.
C-Q7	Calendar information is not updated.
C-A7	Click "Update" to update information.
C-Q8	Is it possible to display the next day's schedule?
C-A8	Yes. Push the right or left arrow on the side of today's date to change to future or past date.
C-Q9	Can I turn on/off the national holidays?
C-A9	No. Change setting on your Google calendar with PC or smartphone.
C-Q10	How can I jump to today's schedule?
C-A10	There is no function to jump to today's schedule. Select the date from the calendar.
C-Q11	Schedule added by smartphone does not show on the calendar.
C-A11	Click "Update" to update your calendar.

3. Frequently Asked Questions (FAQ)

STARLINK (Apps - Calendar)

C-Q12	I can't operate Calendar App.
C-A12	Operation of Calendar App is disabled while driving. Stop the vehicle to operate it.

3. Frequently Asked Questions (FAQ)

STARLINK (Apps - iHeart Radio)

D-Q1	Is iHeart Radio included in STARLINK on my vehicle?
D-A1	Yes.
D-Q2	How can I start listening to iHeart Radio?
D-A2	iHeart Radio can be found on STARLINK. Select iHeart Radio icon from STARLINK menu.
D-Q3	How can I play Live radio Station on iHeart Radio?
D-A3	Click "Live Radio" on the home menu. Click one of the followings. "Stations Near You" will display the closest radio station. "Stations by Location" will display the radio stations by locations. "Music & Entertainment" will display the radio station by music categories.
D-Q4	How can I create Custom Music Station?
D-A4	Click "Create Station" while listening to a live radio station. A new Custom Music Station will be created based on the station you are listening to. You can also click "Create Station" on the home menu, then search artists. A new Custom Music Station will be created by selecting an artist.
D-Q5	What is "Shows & Personalities"?
D-A5	"Shows & Personalities" are on-demand talk stations with customizable access. You will be prompted to log in to Facebook or iHeart Radio account when you play talk stations.
D-Q6	How can I save a station to listen later?
D-A6	Click "Add to Favorites" while you are listening to the station. The station will be saved to your Favorites list. To access to your Favorites list, click "Favorites" on the menu. You will be prompted to log in to Facebook or iHeart Radio account when you save a station to Favorites list.
D-Q7	What do the Thumbs buttons do?
D-A7	When listening to a Customer Music Station, you can personalize the music playing on the station by clicking "Thumbs Up" or "Thumbs Down". When listening to a Live Radio Station, clicking "Thumbs Up" or "Thumbs Down" button will indicate if you like the music or not to the DJ. You will be prompted to log in to Facebook or iHeart Radio when you click "Thumbs" buttons.

3. Frequently Asked Questions (FAQ)

STARLINK (Apps - iHeart Radio)

D-Q8	What does the Discovery button do?
D-A8	<p>When listening to a Customer Music Station, you can personalize the music playing on the station by clicking "Discovery". Choose "Familiar", "Mixed", or "Less Familiar". The station will adjust the music to play depending on your response.</p> <p>You will be prompted to log in to Facebook or iHeart Radio when you click "Discovery" button.</p>

3. Frequently Asked Questions (FAQ)

STARLINK (Apps - Music)

E-Q1	How much music data can be saved on the server?
E-A1	Music App plays music stored in your smartphone. It does not save music on the server.
E-Q2	I can't listen to music on Music App.
E-A2	Music App plays music stored in your smartphone. Check if your smartphone has any music files to play.
E-Q3	Music App does not show album art.
E-A3	Check if music file on your smartphone has album art data.
E-Q4	"???" in song title.
E-A4	Font is not supported by the head unit.
E-Q5	The letters on the tab changed to orange when a list was selected on the list screen. What
E-A5	Track information will be displayed when a list is selected. The letters on the tab will change to orange while showing track information. Music will play by selecting a track.
E-Q6	How can I cancel the track information on the list screen?
E-A6	Click one of the tabs ("Playlists", "Artists", or "Tracks").
E-Q7	Can I search music by steps ("Artist" > "Album" > "Track")?
E-A7	No. Track can be selected under the following tabs only. -Playlists -Artists -Albums
E-Q8	Can I use seek function on the progress bar?
E-A8	No.
E-Q9	When I click Rewind, it plays the current track or the previous track from the beginning.
E-A9	If the music played 5 seconds or more when Rewind was clicked, it plays from the current track from the beginning. If it's less than 5 seconds, it plays the previous track from the beginning. If Rewind is clicked while stopping the music, it always plays the previous music from the beginning.
E-Q10	When I change the track on my smartphone, the loading mark displayed and track information was cancelled. Why?
E-A10	If the track was changed on your smartphone, track information will be cancelled on the head unit. Change track on the head unit in order to keep track information displayed.

3. Frequently Asked Questions (FAQ)

STARLINK (Apps - Music)

E-Q11	I can't find any music Apps on my smartphone that works with the head unit.
E-A11	There is no music Apps to work with the head unit.

3. Frequently Asked Questions (FAQ)

STARLINK (Apps - News)

F-Q1	How can I add or change news sources on News App?
F-A1	Go to "SETTING" > "News" > "CONFIG". Choose news source or directly enter URL.
F-Q2	"Download failed"
F-A2	No internet connection. Check your internet connection. Click Update again.
F-Q3	"Cannot display while driving"
F-A3	High volume articles will be disabled while driving.
F-Q4	"No article is registered"
F-A4	You don't have any article in Favorites.
F-Q5	No news list displayed.
F-A5	No communication with the server. Check if the globe icon is blue.
F-Q6	How can I change news source?
F-A6	Click left or right button on the news source.
F-Q7	Articles are not listed with the newest on the top.
F-A7	Order of the articles displayed is determined by the news source.
F-Q8	Articles are not updated.
F-A8	articles won't be updated automatically. Click Update.
F-Q9	Can I change the order of articles displayed?
F-A9	No.
F-Q10	How can I cancel Favorites?
F-A10	Click Favorites again to cancel.
F-Q11	Do favorites always display by news source?
F-A11	Favorites are always displayed by news source. They can't be mixed.
F-Q12	How can I add the article to Favorites?
F-A12	Click "Star" mark on the left of the news title. Color of Star changes to orange if the articles was added to Favorites.

3. Frequently Asked Questions (FAQ)

STARLINK (Apps - News)

F-Q13	"Please disconnect mobile device and install the STARLINK app on mobile device and try again. "
F-A13	Communication with the server is disconnected. Check the connection.
F-Q14	What is "Star" mark on the news title?
F-A14	You can add the article to Favorites by clicking "Star" mark.
F-Q15	Can I swipe on News App?
F-A15	No. There is no swipe function.

3. Frequently Asked Questions (FAQ)



STARLINK (Apps - Weather)

G-Q1	It takes a long time to change the initial screen.
G-A1	It may take longer for the first time because it is accessing to Weather Information Server. Once the information is stored in cache, it won't take long time.
G-Q2	How can I choose a city?
G-A2	In the App, go to "SETTING" > "Weather" > "CONFIG". Choose city.
G-Q3	How often is weather information updated?
G-A3	STARLINK will update weather every 10 minutes. However, update of the information depends on the Weather Information Server.
G-Q4	What is weather source?
G-A4	http://www.wunderground.com/
G-Q5	No weather information.
G-A5	No communication with the server. Check if the globe icon is blue.
G-Q6	Error message from the Weather Information Server displays.
G-A6	Click Update. There may be error of the weather information on the server.
G-Q7	How can I change location?
G-A7	Click icon on the right of location name to choose different location only if another city has been registered on the App.
G-Q8	How can I go back to the current location?
G-A8	Choose current location in the location change. You can also go to current location by re-starting Weather App.
G-Q9	Is it possible to change temperature unit?
G-A9	No. Temperature displays only in Fahrenheit.
G-Q10	How can I add location?
G-A10	Add location with STARLINK App on your smartphone.
G-Q11	Weather information for the current location won't be displayed.
G-A11	Check your smartphone if GPS is ON.
G-Q12	Location was changed on the smartphone, but it won't change on the head unit.
G-A12	Restart Weather App on the head unit.

4. Glossary

[A] - [M]

[Alphabetical Order]

Term	Definition
aha	<p>Aha is a comprehensive “automotive grade” cloud platform, providing automotive manufacturers a single integration point to bring the widest range of current and future Web infotainment content safely into their vehicles.</p> 
AUX	<p>AUX (Auxiliary Port [Input]) is an analog audio connector, which has a 3.5mm audio jack.</p>
Bluetooth (B/T)	<p>Bluetooth is a high-speed wireless data communication system that uses the 2.4 GHz frequency band prescribed by the Bluetooth SIG (Special Interest Group), with communication at a speed of up to 1 Mbps. Bluetooth is a trademark owned by Bluetooth SIG, Inc.</p> 
Copy-control CD Label Gate CD	<p>This refers to music data that is encoded to prevent saving, alteration, or storing of music data on a computer or other electronic device. Copy Control CDs and Label Gate CDs are labeled with the following symbol. Before using, be sure to refer to information that comes with the product.</p> 
DivX	<p>DivX is a brand name of products created by DivX, Inc., including the DivX Codec which has become popular due to its ability to compress lengthy video segments into small sizes while maintaining relatively high visual quality.</p>
Green route	<p>Searches for the route that conserves the most energy, taking into account the merits of “Fast” and “Short”.</p>
GPS (Global Positioning System)	<p>GPS is positioning system that utilizes satellites traveling at high speed along a 21,000 km orbit. These satellites emit electromagnetic waves that allow the longitude, latitude and height of a given position to be identified.</p>
HD radio	<p>HD Radio, which originally stood for "Hybrid Digital", is the trademark for iBiquity's in-band on-channel (IBOC) digital radio technology used by AM and FM radio stations to transmit audio and data via a digital signal in conjunction with their analog signals.</p> <p><i>Note: HD Radio service available in USA only (as of December 2014)</i></p>
iPhone	<p>iPhone is a smartphone designed and marketed by Apple.</p>
iPod	<p>iPod is a portable media player designed and marketed by Apple.</p>
MirrorLink	<p>MirrorLink function allows smartphone contents to be operated with the unit NOTE: This App is only compatible with certain Nokia and Samsung Phones. See OM (Page 141) for details.</p>

4. Glossary

[M] - [S]

Term	Definition
MP3	MP3 is short for MPEG Audio Layer 3, and is a standard format for audio compression technology. MP3 compresses sound data to eliminate sounds that are outside the range of human hearing, allowing the original file to be compressed to 1/10th their size.
MP4	MP4(MPEG-4) is a multimedia container format standard specified as a part of MPEG-4.
Navigation System	Navigation system is capable of containing map data, determining a vehicle's location and providing suggested direction.
NAVTEQ	Navteq is a Chicago, Illinois-based provider of Geographic Information Systems data and is a dominant company in providing the base electronic navigable maps. The company is a wholly owned subsidiary of Nokia but operates independently.
Pandora	Pandora is a free personalized radio that offers effortless and endless music enjoyment and discovery. (Not available for Canadian model)
PKB-SIGNAL (Parking Brake-Signal)	This is a signal that activates when the parking brake is on.
Positioning	Vehicle position can be obtained when information is received from 3 or more GPS satellites.
REV-SIGNAL (Reverse-Signal)	This is a signal that activates when the shift lever is put into Reverse.
Satellite radio	Satellite radio is an analogue or digital radio signal that is relayed through one or more satellites and thus can be received in a much wider geographical area than terrestrial FM radio stations.
STARLINK	STARLINK is the "in-car connectivity system" that allow the unit to link with smartphone via Bluetooth connection
Micro SD	Micro SD (Secure Digital) is a non-volatile memory card format developed by the SD Card Association for use in portable devices.
SMS	SMS (Short Message Service) is a text messaging service component of phone, web, or mobile communication systems, using standardized communications protocols that allow the exchange of short text messages between fixed line or mobile phone devices.
SPD-SIGNAL (Speed-Signal)	This indicates the vehicle speed pulse signal generated by movement of the vehicle.
SACD (Super Audio CD)	A high-quality audio disc standard that utilizes the DSD (Direct Stream Digital) format. This format enables digital recording in a form extremely similar to analog waves of the original.

4. Glossary

[U] - [number]

Term	Definition
USB (Universal Serial Bus)	USB is a specification to establish communication between devices and a host controller. USB flash drive consists of a flash memory storage device integrated with a USB 1.1 or 2.0 interface.
WMA (Windows Media Audio)	WMA is an audio data compression technology developed by Microsoft.
WMV (Windows Media Video)	WMV is a video data compression technology developed by Microsoft.
XM	XM Satellite Radio is one of two satellite radio services in the United States and Canada, operated by Sirius XM Radio.
2-dimensional and 3- dimensional positioning	<p>GPS calculates position based on a three-point system. Distance from the first satellite is first calculated, and then current position is calculated using information received from three satellites. Even if signals are received from 3 GPS satellites, only latitude and longitude can be measured, giving 2-dimensional positioning. This results in lower accuracy.</p> <p>When information can be obtained from 4 satellites, latitude, longitude, and height measurements can be obtained for 3-dimensional positioning. This is more accurate than 2D positioning, and results in a decreased occurrence of vehicle positioning errors.</p>

