

Subject

Timing Chain Installation Repair Manual Clarification

Market

USA

Service Category

Engine/Hybrid System

Section

Engine Mechanical

Applicability

2013-2014 Scion FR-S

APPLICABLE VEHICLES

2013-2015

FR-S

CONDITION

This document provides some clarification of the timing chain Removal and Installation. Use this procedure in addition to the Repair Manual.

RECOMMENDATIONS
FR-S FA20 Engine Timing Chain REMOVAL and INSTALLATION

The Timing Chain REMOVAL procedure is AS IMPORTANT as the Installation procedure!!! The following clarifies both.

Preliminary Tips:

The "Alignment Marks" (Triangles) on the VVT Controllers are difficult to identify. They are lightly stamped onto the faceplate of the controllers. The following photos show where to find the Alignment Marks on the Intake and Exhaust controllers. All four controllers are different and NOT interchangeable!

Once you identify the controller Triangle "Alignment Marks", mark them with a permanent marker to make them visible.

Bank 1 (Passenger Side) Intake



Bank 2 (Driver Side) Intake



Bank 1 Exhaust



Bank 2 Exhaust

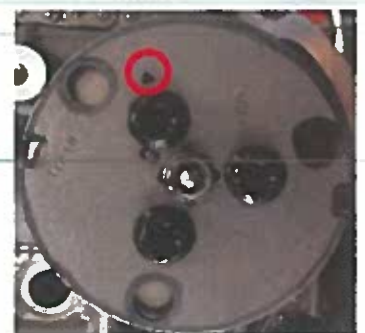

Subject:

Market:

Timing Chain Installation Repair Manual Clarification

USA

Applicability:

2013-2014 Scion FR-S

RECOMMENDATIONS

The Crankshaft Gear "Alignment Mark" is the gear tooth just to the right of the Keyway slot (when looking at the face of the gear). The Keyway aligns with a recess and the Alignment Mark aligns with the tooth next to the recess. In the following photos, the Crank Gear Alignment Mark has been highlighted in white for better visibility.

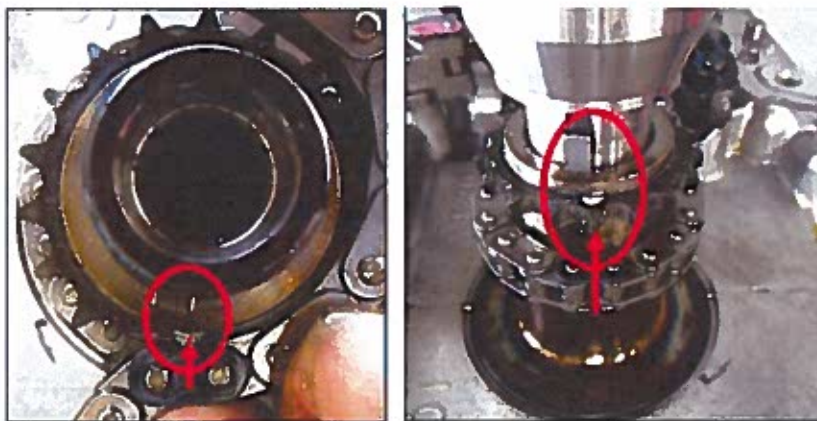

Follow the Repair Manual procedure! This document contains only highlights of the RM procedure to alleviate any misinterpretation of the RM illustrations.

FA20 Timing Chain REMOVAL:

Model Year: 2013	Model: FR-S	Doc ID: RM0000056U900BX
Title: FA20 ENGINE MECHANICAL: TIMING CHAIN: REMOVAL (2013 FR-S)		

REMOVAL

1. REMOVE TIMING CHAIN OR BELT COVER SUB-ASSEMBLY

2. REMOVE CHAIN SUB-ASSEMBLY (for Bank 1)

Bank 1 is Passenger

(a) Temporarily install the pulley belt to the crankshaft.

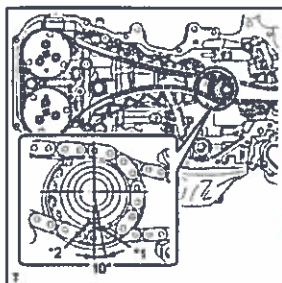

(b) Turn the crankshaft and align the alignment marks of the crankshaft timing gear or sprocket, camshaft timing intake gear assembly RH and camshaft timing exhaust gear assembly RH.

Text in Illustration

"1	Alignment Mark
"2	Key

HINT:

The crankshaft key faces downward at this time.

Subject

Market

Timing Chain Installation Repair Manual Clarification

USA

Applicability

2013-2014 Scion FR-S

RECOMMENDATIONS

Step 2 states "temporarily install the pulley bolt" to be able to turn the crankshaft. To not deform the bolt, a better practice is to use the Oil Pump Drive and Crank Pulley to turn the Crankshaft.

When preparing to remove Bank 1 Timing Chain, rotate the Crankshaft Clockwise so that the Crankshaft Keyway is pointing straight down and the triangle alignment marks on the intake and exhaust controllers are pointing at each other ON BOTH BANKS (see the photo below the illustration).

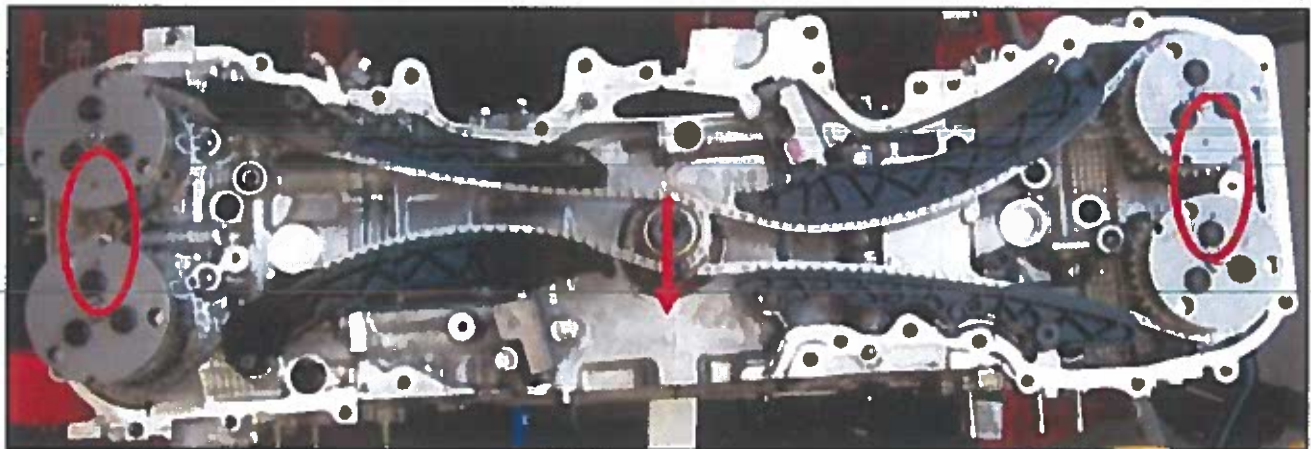
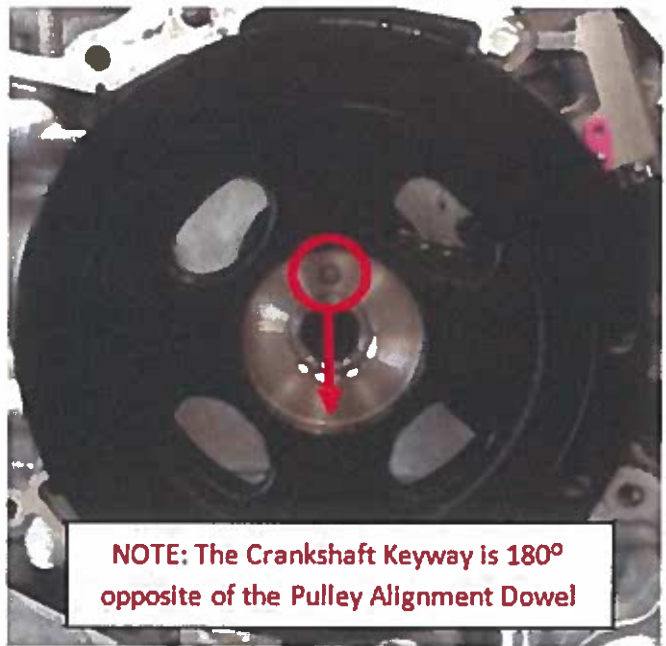
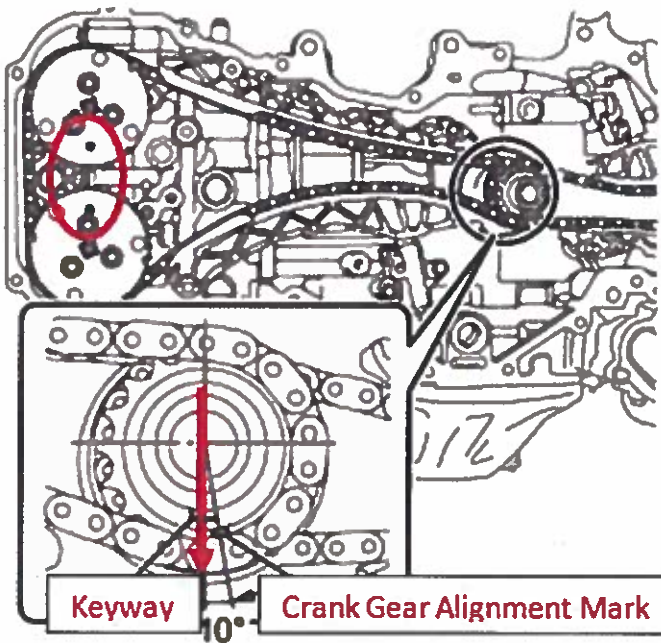

Remove the Bank 1 Timing Chain guide tensioner and guides, and remove the Bank 1 Chain.

Subject

Market

Timing Chain Installation Repair Manual Clarification

USA

Applicability

2013-2014 Scion FR-S

RECOMMENDATIONS

VERY IMPORTANT: DO NOT REMOVE THE BANK 2 GUIDES AND CHAIN YET! THE BANK 2 VALVES AND CAMSHAFTS ARE UNDER TENSION FROM THE VALVE SPRINGS IN THE CURRENT POSITION. REMOVING THE BANK 2 CHAIN AT THIS TIME WILL CAUSE THE BANK 2 CAMSHAFTS TO JUMP TO AN UNDESIREABLE POSITION!

Before removing the Bank 2 Chain, the Crankshaft has to be rotated to move the Bank 2 Camshafts to their UNLOADED positions.

3. REMOVE CHAIN SUB-ASSEMBLY (for Bank 2)

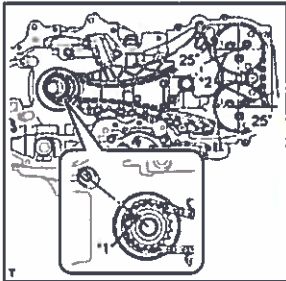

(a) Turn the crankshaft and position each alignment mark on the crankshaft timing gear or sprocket, camshaft timing intake gear assembly LH and camshaft timing exhaust gear assembly LH as shown in the illustration.

Text in Illustration

*1	Key
*2	Alignment Mark

Rotate the Crankshaft clockwise so that the Crankshaft Keyway is pointing up and away from Bank 2 and the Triangle Alignment Marks on the Bank 2 Controllers are as follows:

The Intake controller Triangle Alignment Mark will be facing toward the core plug on the Bank 2 Head.

The Exhaust controller Triangle Mark will face 180° opposite of the Intake controller Triangle Mark.

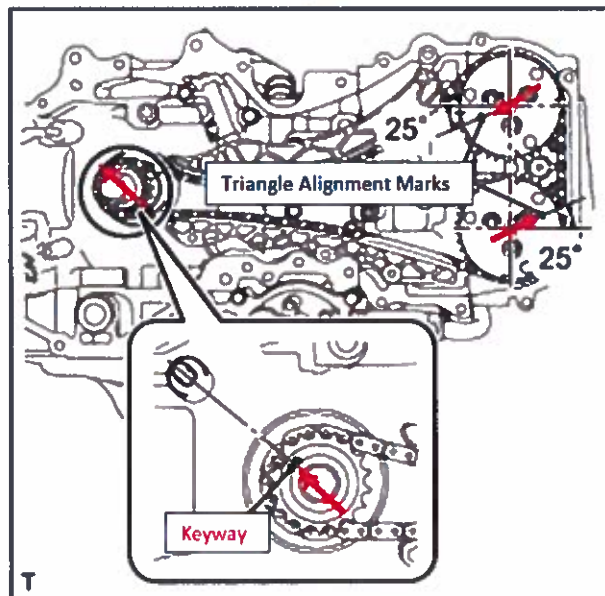

Subject

Market

Timing Chain Installation Repair Manual Clarification

USA

Applicability

2013-2014 Scion FR-S

RECOMMENDATIONS

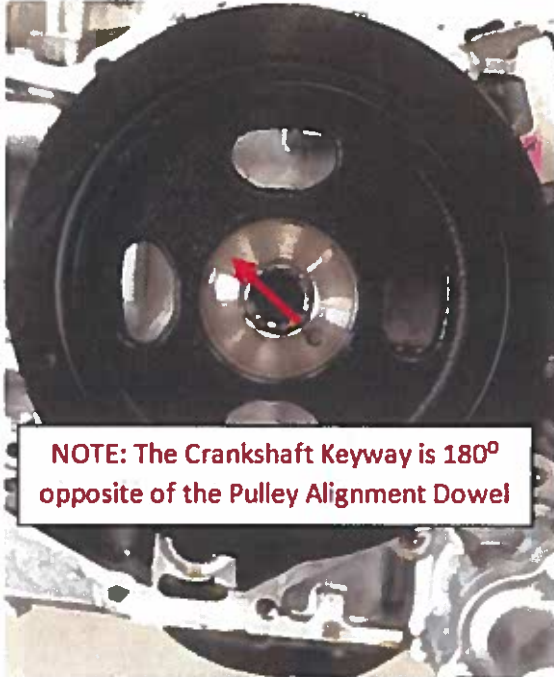

NOTE: The Crankshaft Keyway is 180° opposite of the Pulley Alignment Dowel

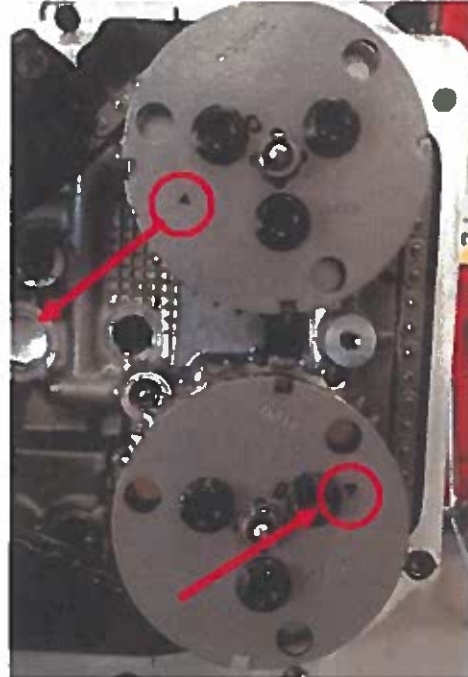

Remove the Bank 2 Timing Chain guide tensioner and guides, and remove the Bank 2 Chain.

Note:

When the Camshafts are in their UNLOADED positions, Bank 1 Intake and Exhaust Camshafts should rotate freely approximately 100°.

Bank 2 Exhaust Camshaft should also rotate freely, but Bank 2 Intake Camshaft will NOT rotate freely. The valves are unloaded but the Camshaft is locked in place!

NOTICE:

- With the chain sub-assembly removed, the valve heads may contact each other if the camshafts are turned, causing the valve stems to bend. To avoid this, do not turn the exhaust camshaft LH more than the zero-lift range (the range where the camshaft can be turned lightly by hand).
- At this time, the No. 1 and No. 4 pistons are located near TDC. If the intake camshaft is turned, the valves may come into contact with the piston, causing the valve stems to bend. To avoid this, do not turn the intake camshaft LH.

Timing Chain Removal is complete.

Subject:

Timing Chain Installation Repair Manual Clarification

Market:

USA

Applicability:

2013-2014 Scion FR-S

RECOMMENDATIONS
FA20 Timing Chain INSTALLATION:

Timing Chain installation is essentially the reverse order of removal. However there are some tips to ease installation:

VVT Controller Timing Marks: On the side of the controllers are grooves that the pink links on the Timing Chain will align with. It is recommended to highlight the grooves with a permanent marker for better visibility and identification.

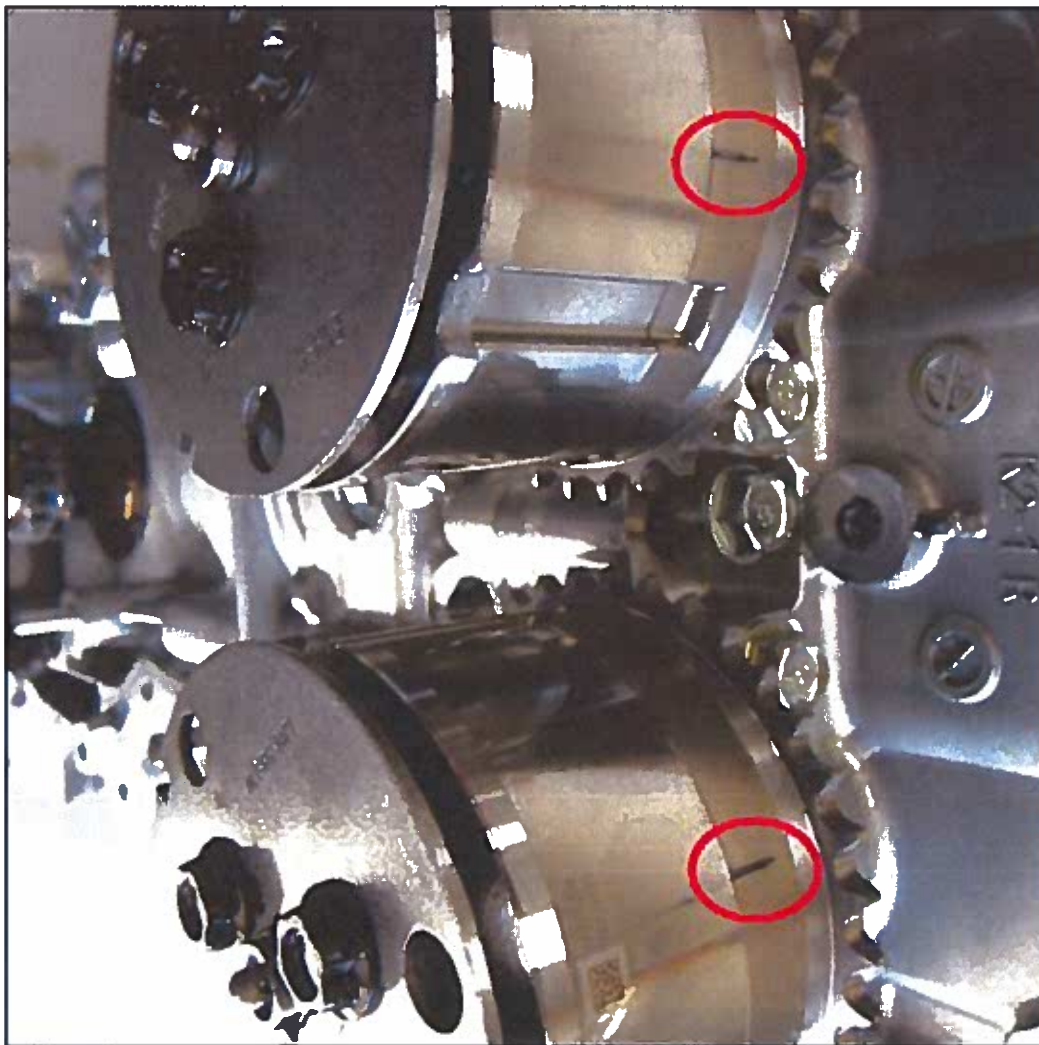

Subject

Timing Chain Installation Repair Manual Clarification

Market

USA

Applicability

2013-2014 Scion FR-S

RECOMMENDATIONS

Model Year: 2013	Model: FR-S	Doc ID: RM0000056U7009X
Title: FA20 ENGINE MECHANICAL: TIMING CHAIN: INSTALLATION (2013 FR-S)		

INSTALLATION

1. INSTALL CHAIN SUB-ASSEMBLY (for Bank 2)

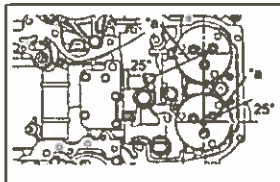

(d) Align the alignment mark on the camshaft timing intake gear assembly LH and camshaft timing exhaust gear assembly LH with the position shown in the illustration.

NOTICE:

To avoid damaging the valves, do not turn the camshaft timing intake gear assemblies more than the zero-lift range (the range where camshaft timing intake gear assemblies can be turned lightly by hand).

Text in Illustration

"a	Alignment Mark
----	----------------

Ensure the Triangle Alignment Marks on the Bank 2 controllers are facing the proper directions:

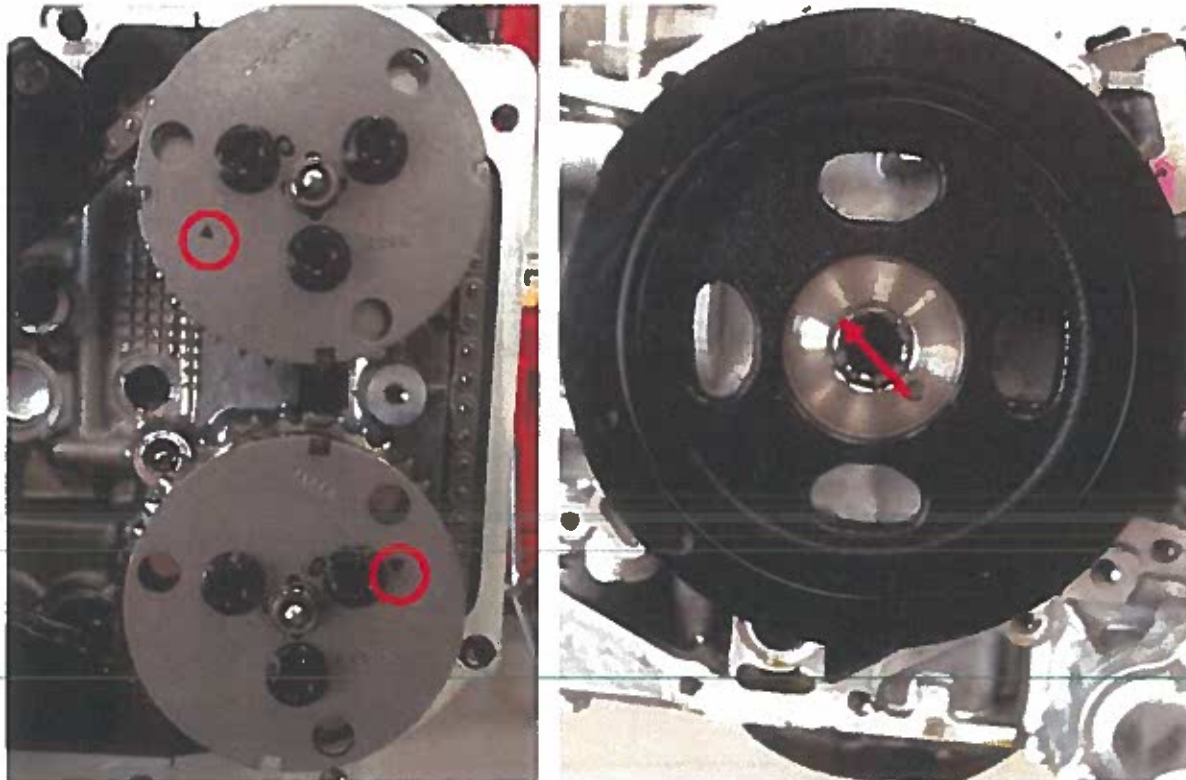

Set the Crankshaft so the Keyway is pointing up and away from Bank 2.

Subject

Timing Chain Installation Repair Manual Clarification

Market

USA

Applicability

2013-2014 Scion FR-S

RECOMMENDATIONS

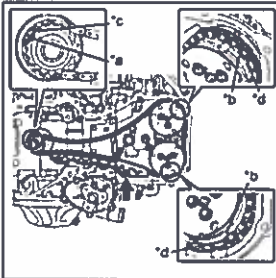

(e) Align the timing chain mark plate (blue) with the alignment mark of the crankshaft timing gear or sprocket.

Text in Illustration

"a	Alignment Mark
"b	Timing Mark
"c	Mark plate (Blue)
"d	Mark plate (Pink)

(f) Align the timing chain mark plate (pink) with the timing mark on the camshaft timing intake gear assembly LH.

(g) Align the timing chain mark plate (pink) with the timing mark on the camshaft timing exhaust gear assembly LH.

Hang the Bank 2 Chain so the BLUE link aligns with the Alignment Mark on the Crank Gear and the PINK links align with the Timing Marks on the side of the controllers as illustrated below:

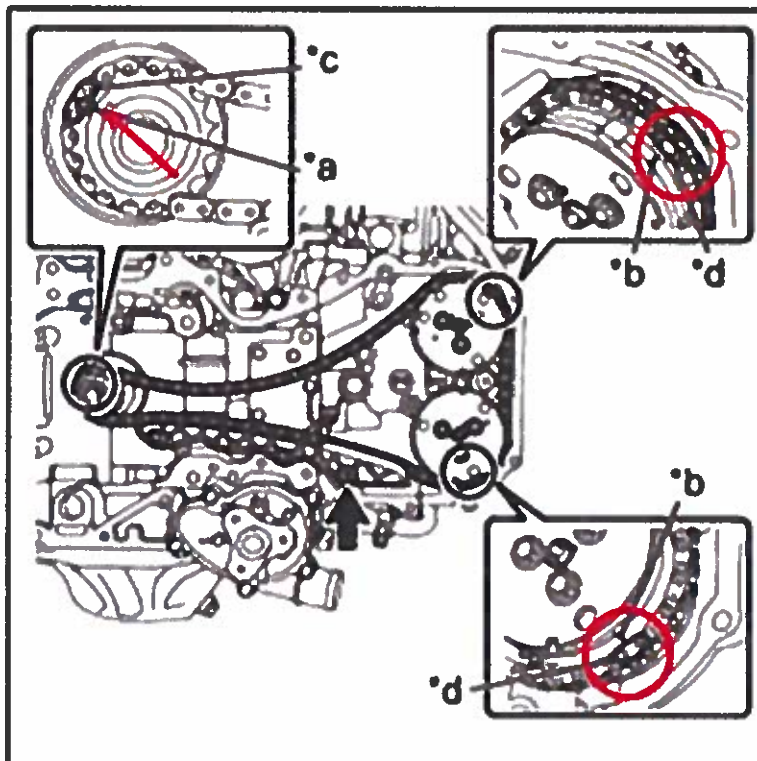

Subject

Timing Chain Installation Repair Manual Clarification

Market

USA

Applicability

2013-2014 Scion FR-S

RECOMMENDATIONS

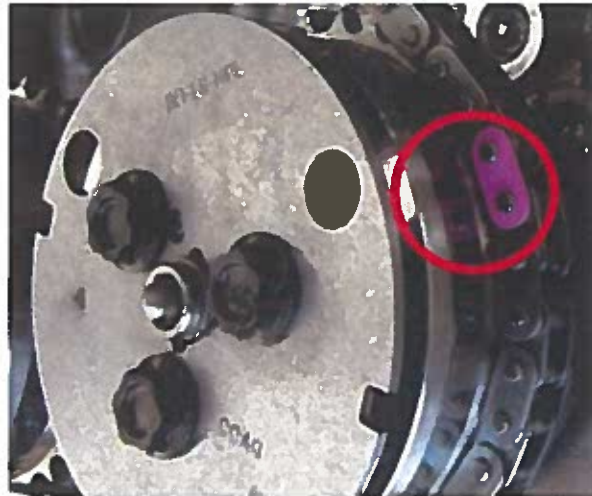
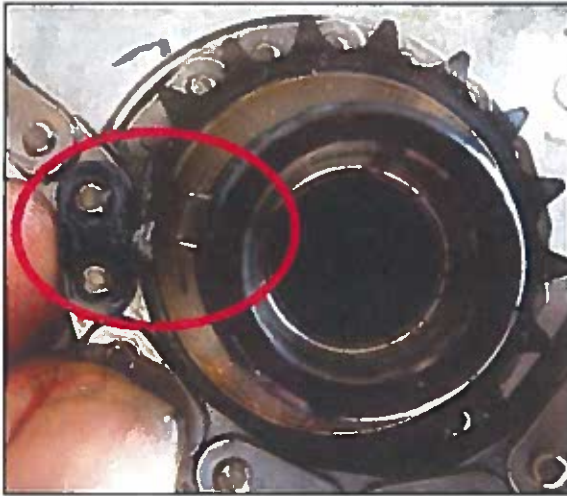

Install the Bank 2 Timing Chain guides and Guide Tensioner as per the RM.

NOTE: In order to hang the Bank 1 Chain, the Crankshaft has to be rotated so that the Crankshaft Keyway faces straight down and the Triangle Alignment Marks on the Bank 2 controllers point at each other.

The Repair Manual states to rotate the Crankshaft *clockwise* and check for any binding before installing Bank 1 Chain:

- (o) Temporarily install the pulley bolt to the crankshaft.
- (p) Turn the crankshaft clockwise, and make sure that there are no abnormal conditions.

NOTICE:

Be sure to perform this confirmation.

2. INSTALL CHAIN SUB-ASSEMBLY (for Bank 1)

When rotating the crankshaft clockwise, in order to get the Keyway facing down and the Bank 2 controller Alignment Marks to face each other, the crankshaft has to be rotated more than one revolution, and the colored links on the Timing Chain will **no longer be in alignment** with the Timing Marks on the controllers and Crank Gear.

Subject

Market

Timing Chain Installation Repair Manual Clarification

USA

Applicability

2013-2014 Scion FR-S

RECOMMENDATIONS

TIP:

After installing the Bank 2 Chain, if the crankshaft is rotated **Counterclockwise** approximately 135° so that the Keyway is facing straight down, the Triangle Alignment Marks on the Bank 2 controllers will be facing each other and the colored links on the Timing Chain will still be in alignment with the Timing Marks on the controllers and Crank Gear.

The engine is now positioned for the Bank 1 Timing Chain to be installed. And after Bank 1 Timing Chain installation, ALL the links on both Timing Chains can be checked to ensure that ALL the links align with their Timing Marks (before installing the Timing Cover). At that point rotate the Crankshaft **Clockwise** to confirm there are no abnormal conditions.

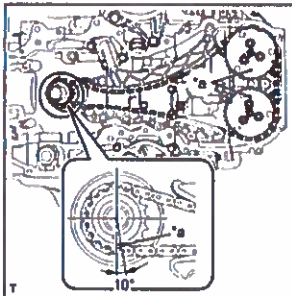

(c) Turn the crankshaft and align the alignment marks of the crankshaft timing gear or sprocket, camshaft timing intake gear assembly LH and camshaft timing exhaust gear assembly LH shown in the illustration.

Text in Illustration

"a	Alignment Mark
----	----------------

HINT:

When the marks are aligned with the positions in the illustration, crankshaft key faces directly underneath.

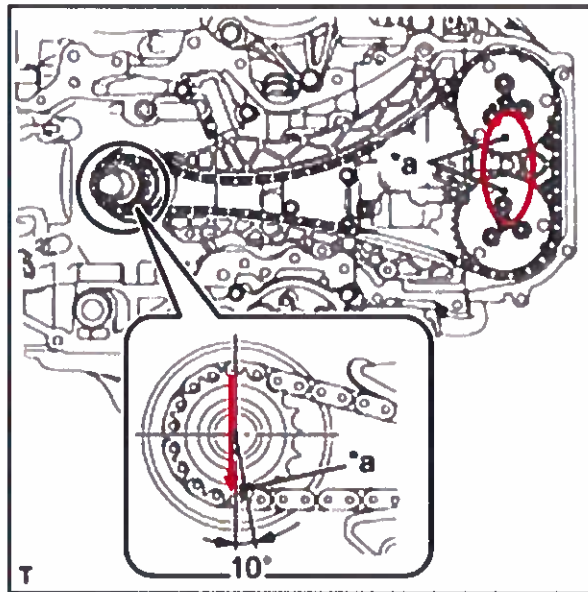

Subject

Timing Chain Installation Repair Manual Clarification

Market
USA

Applicability

2013-2014 Scion FR-S

RECOMMENDATIONS

Driver Side Bank (Bank 2)

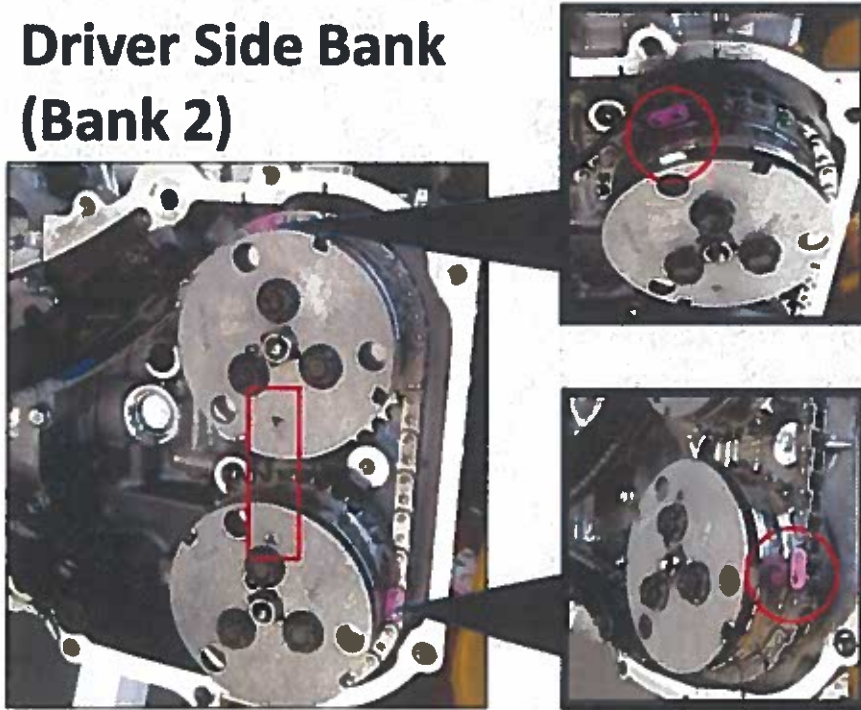

(d) Align the alignment marks of the camshaft timing intake gear assembly RH and camshaft timing exhaust gear assembly RH as shown in the illustration.

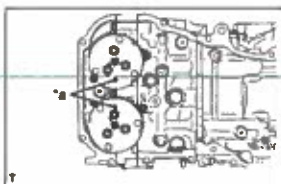

NOTICE:

To avoid damaging the valves, do not turn the camshaft timing intake gear assembly RH and camshaft more than the zero-lift range (the range where the camshaft timing intake gear assembly can be turned lightly by hand).

Text in Illustration

*a

Alignment Mark

Align the Bank 1 controllers so the Triangle Alignment Marks point at each other as shown in the illustration below:

Subject

Market

Timing Chain Installation Repair Manual Clarification

USA

Applicability

2013-2014 Scion FR-S

RECOMMENDATIONS

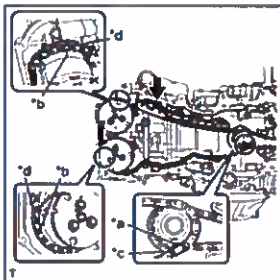
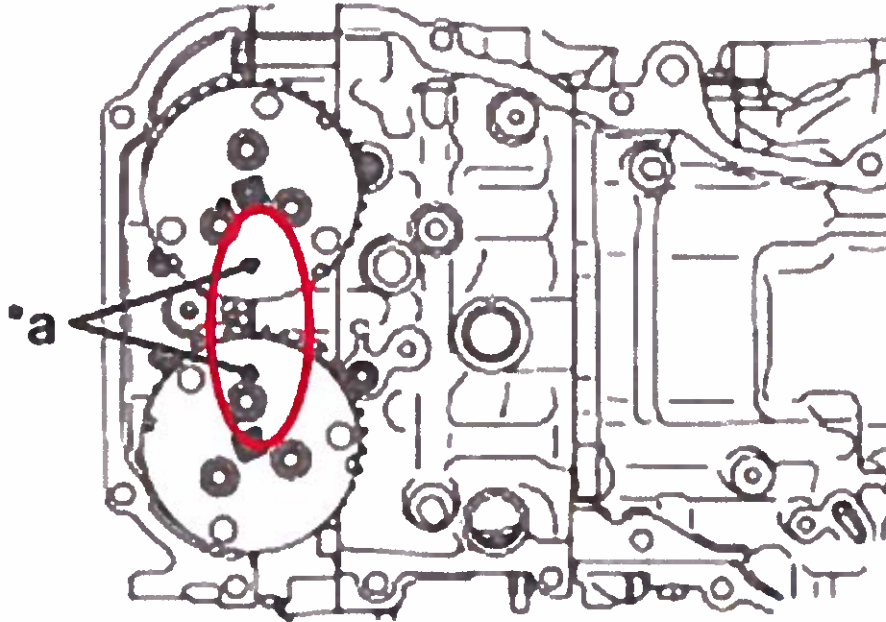

(e) Align the timing chain mark plate (blue) with the alignment mark on the crankshaft timing gear or sprocket.

Text in Illustration

"a	Alignment Mark
"b	Timing Mark
"c	Mark plate (Blue)
"d	Mark plate (Pink)

(f) Align the timing chain mark plate (pink) with the timing mark on the camshaft timing intake gear assembly RH.

(g) Align the timing chain mark plate (pink) with the timing mark on the camshaft timing exhaust gear assembly RH.

Hang the Bank 1 Chain so the BLUE link aligns with the Alignment Mark on the Crank Gear and the PINK links align with the Timing Marks on the side of the controllers as illustrated below:

Subject

Timing Chain Installation Repair Manual Clarification

Market
USA

Applicability

2013-2014 Scion FR-S

RECOMMENDATIONS

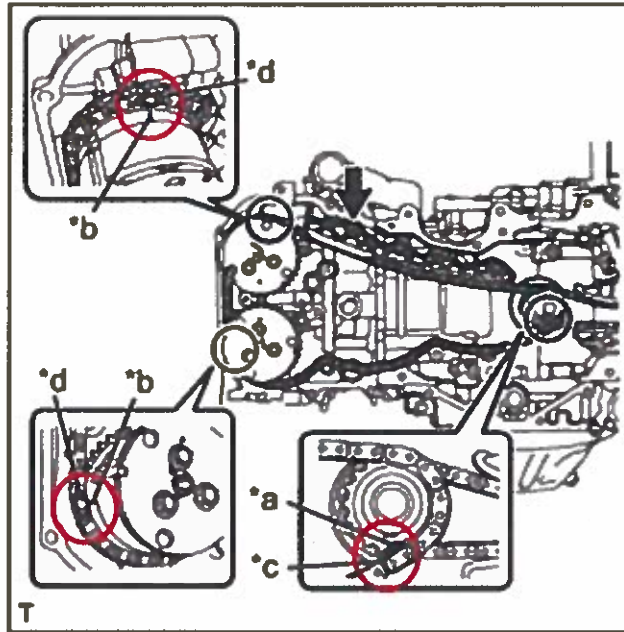

Passenger Side Bank (Bank 1)

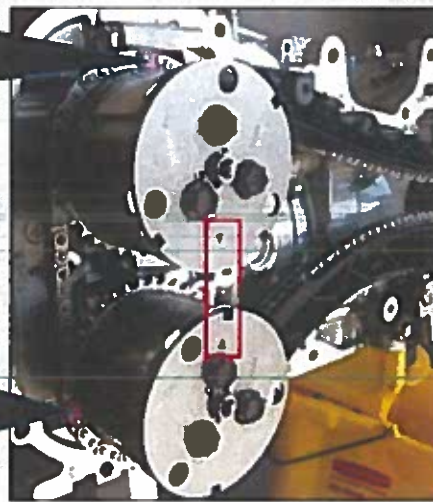

Install the Bank 1 Timing Chain guides and Guide Tensioner as per the RM.

Subject

Timing Chain Installation Repair Manual Clarification

Market

USA

Applicability

2013-2014 Scion FR-S

RECOMMENDATIONS

RECHECK ALL TIMING MARKS ARE CORRECT:

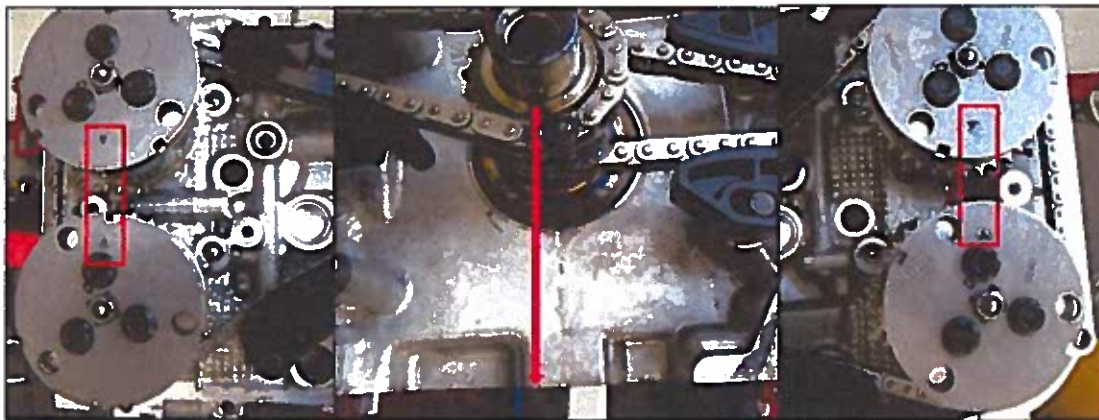
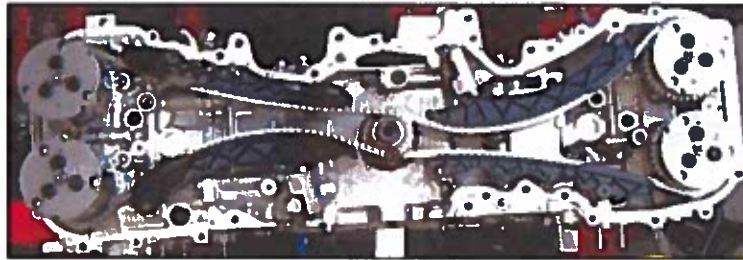

Passenger Side Bank (Bank 1)



Driver Side Bank (Bank 2)



And NOW rotate the Crankshaft *Clockwise* to confirm there are no abnormal conditions.

Timing Chain Installation is Complete

Subject

Market

Timing Chain Installation Repair Manual Clarification

USA

Applicability

2013-2014 Scion FR-S

LINK REFERENCES

1. [FA20 ENGINE MECHANICAL: TIMING CHAIN: REMOVAL; 2013 MY FR-S \[03/2012 - ???????\]](#)
2. [FA20 ENGINE MECHANICAL: TIMING CHAIN: INSTALLATION; 2013 MY FR-S \[03/2012 - ???????\]](#)

