

Service Campaign Bulletin

Campaign No. 2013010001, February 2013

TO: ALL MERCEDES-BENZ CENTERS

SUBJECT: **Model 207, 212, 218, 221, 231 with Engine M278, Model Year 2013
Remove Check Valve for Left and Right Secondary Chain Tensioners**

This Service Campaign has been initiated because Daimler AG (DAG) has determined that the check valve of the left and right secondary chain tensioners installed at the factory may have been pressed too deep into the cylinder heads. As a result oil supply into the cylinder head cannot be ensured. An authorized Mercedes-Benz dealer will remove the check valve of the left and right side secondary chain tensioners at the next workshop service.

Prior to performing this Service Campaign:

- Please check VMI to determine if the vehicle is involved in the Campaign and if it has been previously repaired.
- Please review the entire Service Campaign bulletin and follow the repair procedure exactly as described.

Please note that Recall and Service Campaigns **do not expire** and may also be performed on a vehicle with a vehicle status indicator.

Approximately 167 vehicles are affected.

Order No. P-SC- 2013010001

This bulletin has been created and maintained in accordance with MBUSA-SLP S423QH001, Document and Data Control, and MBUSA-SLP S424HH001, Control of Quality Records.

Service Campaign Bulletin

Service Campaign Bulletin

Service Campaign Bulletin

Service Campaign Bulletin

Service Campaign Bulletin

Procedure

A. Remove Left and Right Secondary Chain Tensioner

Note:

Do not remove chain tensioners at the same time. After removal of the first chain tensioner, remove the corresponding check valve, reinstall the chain tensioner and continue with the second chain tensioner.

Note: (regarding below WIS instructions)

- Drain coolant at radiator only, do not drain coolant from engine block.
 - Using a Torx 40 bit X 72 mm (locally sourced tool, see special tools section) will allow for easier access to lower oil filter housing bolts.
1. For models 207, 212, 218 refer to WIS: AR05.10-P-7800ELB.
 2. For models 216, 221 refer to WIS: AR05.10-P-7800MMB.
 3. For model 231 refer to WIS: AR05.10-P-7800RKB and additional information below:

CAUTION!

Refer to safety precautions located in WIS: AS20.00-Z-0001-01A, AS00.00-Z-0010-01A, AH20.00-N-2080-01A.

- Remove/install charge air ducts (refer to attached WIS document on page 6).
- Remove lower engine compartment panels, refer to WIS: AR61.020-P-1105RK.
- Drain coolant from radiator (arrow, Figure 1).

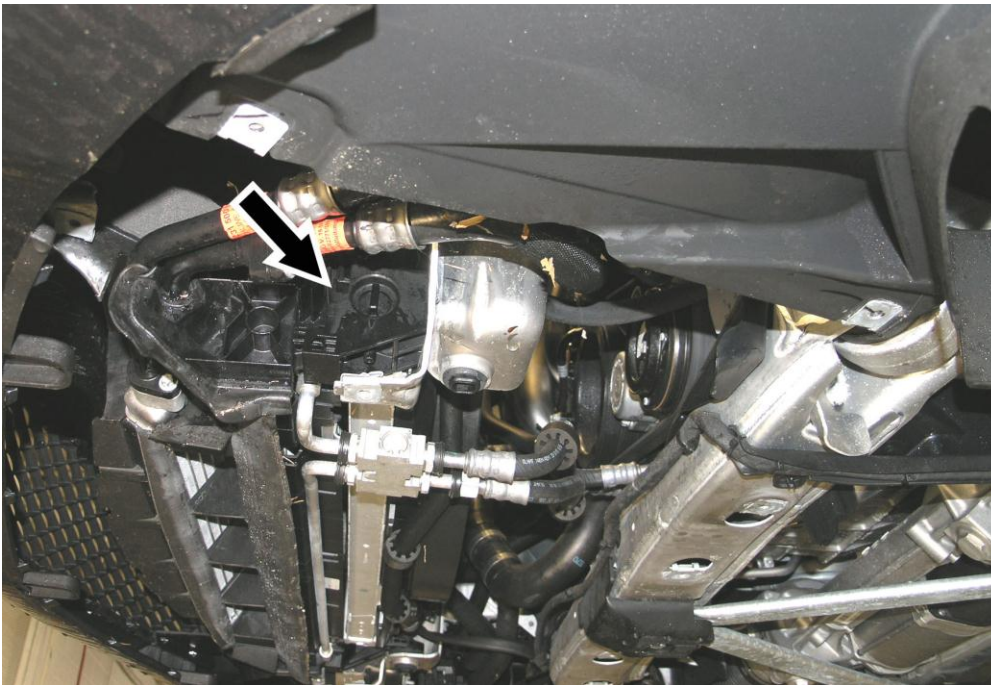

Figure 1 (model 231)

- Refill cooling system and bleed (after performing subject B), refer WIS: AR20.00-P-1142-04A
- Check cooling system for leaks (after performing subject B), refer to WIS document on page 9.

B. Remove Check Valve from Cylinder Head

1. Set puller W 605 589 00 33 00 with washers and an M6 nut to a remaining length of approx. 4 mm (Figure 2).

**Figure 2**

2. Remove check valve (A, Figure 3) with set puller (B) W 605 589 00 33 00 from cylinder head.

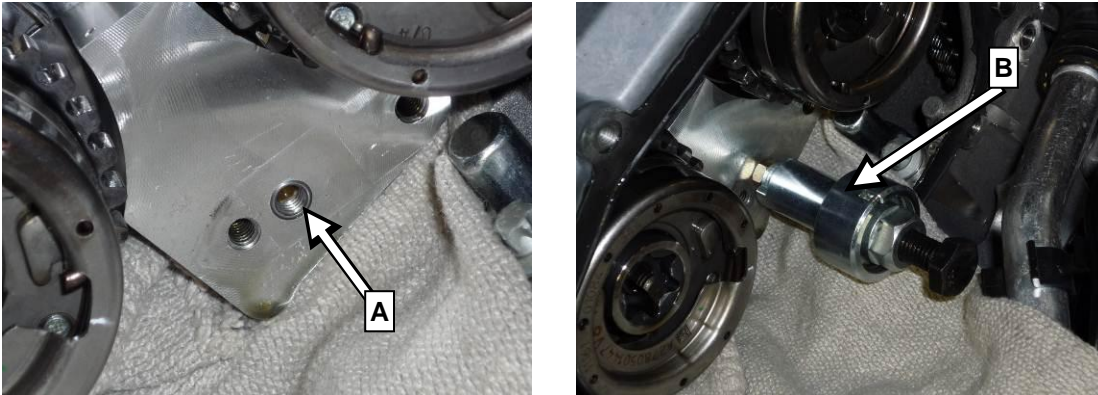
**Figure 3** (Shown on right side)**Note:**

Cover chain case opening with rag so no parts can fall in.

4. Assemble in the reverse order.

Note:

Be sure to refill cooling system, bleed system, and check for leaks.

Special Tools

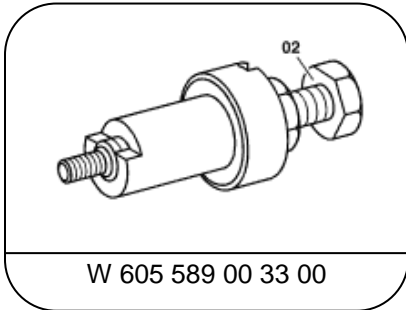

W 605 589 00 33 00

Puller



Locally Sourced

Torx 40 bit x 70 mm*

* Please be advised that the Torx 40 bit x 70mm (2.75") length is available through your Local Tool dealers (e.g. Snap-on, Matco, Mac) or online via these websites:

- Wiha Tools @ <http://www.wihatools.com/700seri/745ser70.htm>
- All Spec @ <http://www.all-spec.com/products/49ATX40.html>

Torx Tool Part Numbers:

Wiha part number 74561 - Torx 40 bit by 70mm (2.75") length

Facom part number EXR140L - Torx 40 bit by 70mm (2.75") length

Note (regarding WIS documents referenced in this Procedure):

Replacement of parts not listed in the parts table of this Procedure are not claimable under this campaign. If replacement of additional part(s) is necessary, check coverage prior to submitting under warranty.

Primary Parts Information

Qty.	Part Name	Part Number	Estimated Replacement Rate
16	Front cover hexalobular bolt (left, right)	N 000000 006365	100%
1	Thermostat O-ring	A 022 997 64 45	
1	Thermostat molded seal	A 278 201 02 80	
1	Oil filter housing molded seal	A 278 184 02 80	
1 (15 vehicles)	Loctite 7200 cleaner ¹⁾	A 010 989 90 71	
1 (5 vehicles)	Loctite 7063 cleaner spray ²⁾	A 001 986 71 71 10	
1	Loctite 5970 sealant	A003 989 98 20 10	
1 Gal.	Engine Coolant	BQ 1 03 0004	
4	O-rings	A 023 997 44 45	

¹⁾ Loctite 7200 - sufficient for 15 vehicles, submit as Local Purchase - LTG00117, Qty 1, handling is included.

²⁾ Loctite 7063 - sufficient for 5 vehicles, submit as Local Purchase - LTC00242, Qty 1, handling is included.

Note:

- Please be aware that only the part number(s) referenced in the Campaign Bulletin is/are approved for use to repair the vehicle. Repairs performed using any other part(s) will not have been performed in accordance with the campaign. Accordingly, warranty claims submitted with reference to an improper part number(s) will be denied.
- The following allowable labor operation should be used when submitting a warranty claim for this repair:

Warranty Information

Operation: Remove check valve for secondary drive chain tensioner (02-7954).

Damage Code	Operation Number	Labor Time (hrs.)
05 900 31 7	02-7954	4.2

Note:

Labor times are subject to change.

AR09.41-P-8620RKB Remove/install charge air ducts



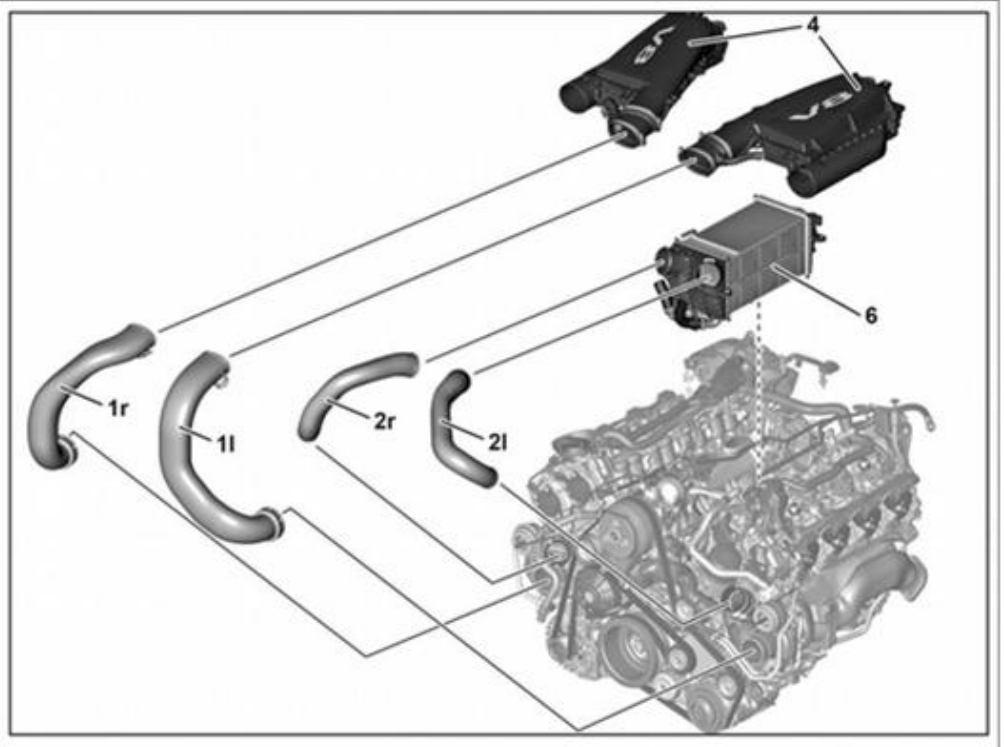
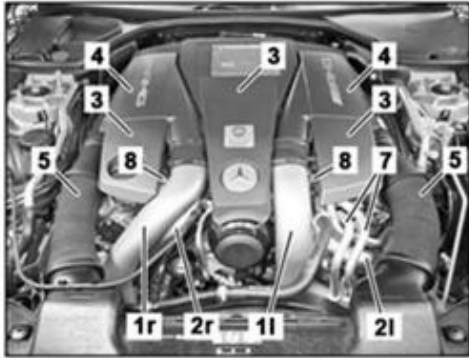

17.10.12

















ENGINE 157, 278 in MODEL 231



1l Upper charge air duct on the left
 1r Upper charge air duct on the right
 2l Lower charge air duct on the left
 2r Lower charge air duct on the right
 3 Engine cover

4 Air cleaner housing
 5 Engine suction air duct
 6 Charge air cooler
 7 Oil line
 8 Screw/bolt

	Remove/install		
1	Remove engine covers (3)		
2	Remove right and left engine suction air duct (5)		
3.	Remove oil lines (7) for engine oil cooling from oil filter housing and lay to the side outside of the working area	ENGINE 157 in MODEL 231  Plug openings.  Installation: Replace sealing rings and clean connection area of the oil lines (7).  Record plug	129 589 00 91 00

4	Release clamp for upper charge air duct on the left (1l) or for upper charge air duct on the right (1r) on boot air filter housing (4)	 The boot remains on the air filter housing (4).	
5	Release clamp for upper charge air duct on the left (1l) or for upper charge air duct on the right (1r) on turbocharger	 The boot remains on the upper charge air duct on the left (1l) or for upper charge air duct on the right (1r).	
6	Unscrew screw/bolt (8) upper charge air duct on the left (1l) or for upper charge air duct on the right (1r) on cylinder head cover	 Bolt, charge air manifold to front cover/oil filter housing/cylinder head/cylinder head cover	BA09.40-P-1008-01R
7	Remove upper charge air duct on the left (1l) or upper charge air duct on the right (1r)	 Seal openings on air intake pipe (6) and turbocharger.  Set of protective caps	001 589 02 91 00
8	Remove air filter housing (4)		
9	Release clamp for upper charge air duct on the left (2l) or for upper charge air duct on the right (2r) on charge air cooler (6)	 The boot remains on the charge air cooler (6).	
10	Release clamp for boot for lower charge air duct on the left (2l) or for lower charge air duct on the right (2r) on turbocharger	 The boot remains on the turbocharger.	
11	Remove bolts for right lower charge air duct (2r) from cylinder head	 When removing the right lower charge air duct (2r)	
12	Remove screw/bolts for lower charge air duct on the left (2l) from cylinder head and oil filter housing	 When removing the lower charge air duct on the left (2r)  Bolt, charge air manifold to front cover/oil filter housing/cylinder head/cylinder head cover	BA09.40-P-1008-01R
13	Remove lower charge air duct on the left (2l) or lower charge air duct on the right (2r)	 Seal openings on air intake pipe (6) and turbocharger.  Set of protective caps	001 589 02 91 00
	Check		
14	Check boots, rubber seal and clamp for damage	 Replace if necessary.	
15	Install in the reverse order		
	Check		
 Danger!	Risk of accident from vehicle starting off by itself when engine running. Risk of injury (bruises and burns) resulting from working on the engine while it is being started or when it is running.	Secure vehicle to prevent it from starting off by itself. Wear closed and snug-fitting work clothes. Do not touch hot or rotating parts.	AS00.00-Z-0005-01A
16	Carry out engine test run, checking the engine for proper operation and leaks		

 Turbocharger

Number	Designation		ENGINE 157	ENGINE 278
BA09.40-P-1008-01R	Bolt, charge air manifold to front cover/oil filter housing/cylinder head/ cylinder head cover	Nm	9	9

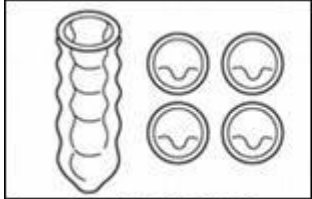

001 589 02 91 00

Set of protective caps

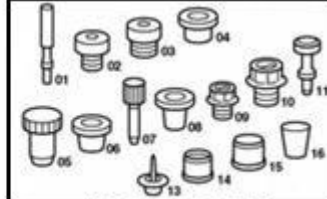

129 589 00 91 00

Record plug

AR20.00-P-1010RK	Inspecting cooling system for leaks	15.5.12
------------------	-------------------------------------	---------

157, 276, 278 in MODEL 231











Shown on engine 276







- 1 Cap
- 2 Coolant expansion reservoir
- 3 Tester cap
- 4 Pressure pump



P20.00-2455-05

☒	Removing		
⚠ Danger!	<p>Risk of injury caused by fingers being pinched or crushed when removing, installing or aligning hoods, doors, trunk lids, liftgates or sliding roof</p>	Keep body parts and limbs well clear of moving parts.	AS00.00-Z-0011-01A
⚠ Danger!	<p>Risk of injury to skin and eyes caused by scalding from contact with hot coolant spray. Risk of poisoning caused by swallowing coolant.</p>	<p>Do not open cooling system unless coolant temperature is below 90°C. Open cap slowly and release the pressure. Do not pour coolant into beverage containers.</p> <p>Wear protective gloves, protective clothing and safety glasses.</p>	AS20.00-Z-0001-01A
1	Switch on ignition		

2	Adjust heater to maximum heat output		
3	Unscrew cap (1) from coolant expansion reservoir (2)	 Unscrew cap (1) slowly and relieve overpressure.	
4	Check coolant level and antifreeze content coolant	 If antifreeze content of coolant is too small, either antifreeze protection must be added or the coolant must be replaced.	
	Notes on coolant		AH20.00-N-2080-01A
5	Screw on test cap (3) at coolant expansion reservoir (2)	 Test cap	210 589 00 91 00
6	Connect pressure pump (4) at tester cap (3)	 Pressure pump	124 589 24 21 00
		 Test cap	210 589 00 91 00
7	Apply test pressure to cooling system	 The specified test pressure must not be exceeded. To avoid any damage to the cooling system.	BE20.30-P-1005-01A
	Checking		
8	Check condition and seating of the Henn coupling.	 Replace catch springs if necessary.	AR09.41-P-1311-01AL
9	Perform visual inspection on coolant carrying components	 Check condition and coolant loss for all coolant carrying components and connections. The coolant carrying components should be checked for inner leaktightness if there is no external coolant loss. There is the possibility, for example, that coolant can find its way over a defective cylinder head gasket into the combustion chamber or over a defective water heat exchanger into the oil circuits.	
	Install		

10	Relieve test pressure in cooling system	 To do this actuate pressure relief button on the  pressure pump (4)	
		 Pressure pump	124 589 24 21 00
11	Remove pressure pump (4) from tester cap (3)		
12	Unscrew tester cap (3) from coolant expansion reservoir (2)		
13	Switch off ignition		
14	Check coolant level and antifreeze content coolant	 Mixture ratio for coolant	BF20.00-P-1001-04A
	Notes on coolant		AH20.00-N-2080-01A
	Notes on coolant level		AH20.00-P-1142-01V
15	Screw cap (1) onto coolant expansion reservoir (2)		

Cap for radiator or expansion reservoir

Number	Designation	2-stage cap
BE20.30-P-1005-01A	Test pressure for pressure-testing cooling system	bar gage 1.4

 **Mixture ratio for coolant**

Number	Designation	Engine all
BF20.00-P-1001-04A	Mixture ratio for coolant	Antifreeze/water up to -37°C 50/50
		up to -45°C 55/45
	Specifications for service products	Sheet BB00.40-P-0310-01A

			Sheet	BB00.40-P-0325-00A
--	--	--	-------	--------------------

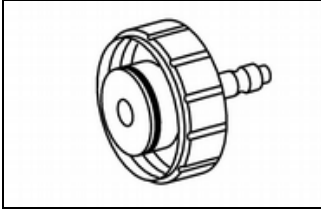

210 589 00 91 00

Test cap

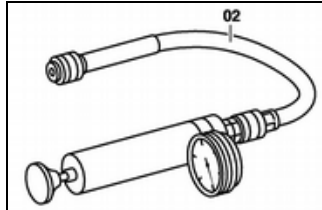

124 589 24 21 00

Pressure pump