

ATTENTION:

- GENERAL MANAGER
- PARTS MANAGER
- CLAIMS PERSONNEL
- SERVICE MANAGER

IMPORTANT - All Service Personnel Should Read and Initial in the boxes provided, right.



QUALITY DRIVEN® SERVICE

PRODUCT CAMPAIGN BULLETIN

APPLICABILITY: 2003-2004 Baja
 2003-2008 Legacy and Outback
 2004-2005 Impreza, WRX, STI

SUBJECT: Takata Front Passenger Air Bag Inflator Replacement

NUMBER: WQR-53R
DATE: June 2, 2015
REVISED: April 12, 2016
NHTSA ID: 15V-323

UPDATE – April 2016: New and different inflators are available for affected 2004-2005 Impreza, WRX, and STI vehicles. As a result, there are different installation instructions depending on the inflator being installed. Please refer to the appropriate service procedure instructions and parts information which were updated to reflect the new parts.

The vehicles included in this consolidated national recall include the following:

- Affected 2004-2005 Impreza, WRX, and STI models from the national expansion of the WQP-51 recall
- 2003-2004 Legacy, Outback, and Baja vehicles affected by and not yet repaired under the WQL-48 recall
- 2004 Impreza, WRX, and STI vehicles affected by and not yet repaired under the WQL-48 recall
- 2005-2008 Legacy and Outback vehicles, including the 2005 models not yet repaired under the WQP-51 recall

In the event of a crash necessitating deployment of the passenger side frontal air bag, the front passenger-side air bag inflator in these vehicles could rupture with metal fragments striking the vehicle occupants potentially resulting in serious injury or death.

Although the percentage of affected vehicles is unknown, this recall will involve replacing the front passenger air bag inflator on all of the potentially affected vehicles.

AFFECTED VEHICLES

This condition may exist on certain 2003-2004 model year Legacy, Outback, and Baja vehicles, and certain 2004-2005 model year Impreza, WRX, and STI vehicles and 2005-2008 model year Legacy and Outback models listed below.

MODEL YEAR	MODEL	STARTING PRODUCTION DATE	ENDING PRODUCTION DATE
2003	Legacy	01/22/2003	05/14/2003
2004		03/17/2003	02/10/2004
2005		11/25/2003	05/27/2005
2006		11/09/2004	07/12/2006
2007		12/08/2005	03/12/2007
2008		11/16/2006	05/05/2008

Continued...

MODEL YEAR	MODEL	STARTING PRODUCTION DATE	ENDING PRODUCTION DATE
2003	Outback	02/18/2003	04/15/2003
2004		02/28/2003	02/11/2004
2005		12/01/2003	06/02/2005
2006		11/09/2004	07/13/2006
2007		12/08/2005	03/14/2007
2008		11/16/2006	05/05/2008
2003	Baja	01/22/2003	05/06/2003
2004		03/03/2003	07/21/2004
2004	Impreza, WRX, STI	01/08/2003	02/13/2004
2005		02/11/2004	05/31/2005

Vehicle coverage for this recall must be confirmed by using the Vehicle Coverage Inquiry function on subarunet.com.

June 2015: All Subaru Impreza, WRX, and STI vehicles affected by the WQP-51 regional recall that were not yet repaired will be included in the WQR-53 national recall. Any open WQP-51 coverage has been expired.

September 2015: All vehicles affected by the WQL-48 recall that were not yet repaired will be transferred into to the WQR-53 national recall. Any open WQL-48 coverage will be expired once owner notification begins.

January 2016: All 2005 model year Legacy and Outback vehicles affected by the WQP-51 regional recall that were not yet repaired will be included in the WQR-53 national recall. Any open WQP-51 coverage has been expired.

OWNER NOTIFICATION

Notification letters were previously mailed on June 17, 2015 and July 24, 2015 to owners of all Subaru Impreza, WRX, and STI vehicles previously affected by the national expansion of the WQP-51 recall. Copies of those letters are included in this bulletin.

September 2015: Notification letters will be mailed to all owners of vehicles affected by and not yet repaired under the WQL-48 recall. Copies of these letters are also included in this bulletin.

January 2016: Notification letters will be mailed to the affected 2005-2008 model year Legacy and Outback owners with registration history in the high absolute humidity (HAH) areas, as those vehicles are included in the highest priority group (Priority Group 1) as defined in the NHTSA (National Highway Traffic Safety Administration) Coordinated Remedy Order. For more information about this Order, please refer to <http://www.safercar.gov/rs/takata/index.html>. A copy of the notification letter is included at the end of this bulletin.

February 2016: Notification letters will be mailed to the remaining affected 2005-2008 model year Legacy and Outback owners. A copy of the owner notification letter is included at the end of this bulletin.

April 2016: Second owner notification will begin to owners of all affected Impreza, WRX, and STI vehicles that have not had the repair performed yet. Mailings will be phased based on parts supply status, based on the age of the inflator in the vehicle.

RETAILER AFFECTED VIN LISTS

Each Subaru retailer will receive an affected VIN list from their Zone Office when owner notification begins. Vehicles will be assigned to retailers in the affected VIN list as follows:

Continued...

- Original vehicle owners are assigned to the original selling retailer when their current address is within a 100 mile radius of that retailer.
 - If the original selling retailer is inactive, the VIN has been assigned to the nearest active retailer.
 - For any new owners or when original owners live more than 100 miles from the original selling retailer, the VIN has been assigned to the nearest active retailer.
- Important: Retailer affected VIN lists include owner name and address information for vehicles affected by this recall. This information will enable retailers to follow-up with owners of potentially affected vehicles. The lists contain owners' names and addresses obtained from State Motor Vehicle Registration Records. The use of such motor vehicle registration data for any other purpose is unlawful. Accordingly, retailers are required to limit the use of these lists for the purpose of completion of this safety recall.**

SUBARU RETAILER PROGRAM RESPONSIBILITY

Retailers are to promptly perform the applicable service procedures to correct all affected vehicles in their inventory. Additionally, whenever a vehicle subject to this recall is taken into inventory or in for service, necessary steps should be taken to ensure the recall correction has been made before selling or releasing the vehicle.

Any vehicles listed in a recall/campaign that are in the retailer's stock must be:

- Immediately identified.
- Tagged or otherwise marked to prevent their delivery or use prior to inspection and/or repair.
- Repaired in accordance with the repair procedures outlined in this Product Campaign Bulletin.

Please be advised that it is a violation of Federal law for a retailer to deliver a new motor vehicle covered by a recall under a sale or lease until the defect is remedied. In addition, any Authorized Subaru Retailer failing to perform the applicable service procedures to correct all affected vehicles in their inventory prior to the vehicle being placed in service will be in breach of the Subaru Dealer Agreement.

PARTS INFORMATION

The parts required for this recall are the passenger air bag inflator module kits listed below. **New and different inflators are available for affected Impreza, WRX, and STI vehicles. You may receive a different part number than ordered, and the inflator may physically look different from previous replacement parts. As a result, there are different installation instructions depending on which part number is being installed. The parts information listed below and the service procedure information were updated to reflect the new parts.**

PART NUMBER	APPLICABILITY	DESCRIPTION	ORDER QUANTITY
98279AE00A	2003-2004 Legacy, 2003-2004 Outback and 2003-2004 Baja	Air Bag Inflator Module Kit	1
98279FE000	2004-2005 Impreza, WRX, and STI	Air Bag Inflator Module Kit (Inflator Type 1)	1
98279FE070		Air Bag Inflator Module Kit (Inflator Type 2)	1
98279AG00A	2005-2008 Legacy and Outback	Air Bag Inflator Module Kit	1

Continued...

In order to maintain an adequate part supply, SOA requests that retailers only order quantities necessary to satisfy anticipated demand. Orders will be monitored by SOA Parts for reasonableness based on AOR assigned VIN population.

As a reminder, if a customer requests a loaner car due to the insufficient supply of parts, retailers should make every effort to comply with this request, and should follow normal warranty procedures to obtain reimbursement for the loaner car. See Section 8.4.7 of the Claims Policies and Procedures Manual on subarunet.com for details on rental authorizations.

If you have any questions, please contact the Parts Information Coordinators.

PART RETURN PROCEDURES

Please read the 'Inflator Returns' instructions included as 'Appendix A' of this bulletin carefully, as the return procedure has changed.

- A company called **Takata XPO** will arrange pick up of the inflators and return them to Takata.
- FedEx will no longer handle the return shipments. **However, if you do not have a large amount of inflators to pick up, you may be directed to use FedEx for return. Please follow the instructions given to you by Takata XPO.**
- Once a month or upon accumulating 200 kits for return (whichever comes first) please call **Takata XPO** at 1-877-650-3476 for pick up. Please see step 6 of the return instructions.

- If you continue to receive inventory of inflators with the original FedEx documentation, please follow the instructions in step 4b. of the new 'Inflator Returns' instructions. **DO NOT CALL FEDEX.**

- Upon claim approval, Subaru of America, Inc. will generate a Part Return Notice requesting the old and new inflator serial number information only. **DO NOT WAIT FOR **TAKATA XPO** TO PICK UP THE INFLATOR TO SEND THIS INFORMATION TO THE PARTS COLLECTION CENTER (PCC).**
- **IMPORTANT:** Each removed air bag inflator must be returned directly to the supplier, Takata USA, in the same box in which the new one was received.

The shipping box contains a bar code label, which will be used by Takata USA to document the replacement of the old inflator with the new inflator. **Therefore, it is very important that the removed inflator be returned in the exact same box that contained the newly-installed inflator for that vehicle.** If the original box cannot be re-used, please refer to the shipping instructions under "Requesting a new box/ shipping labels."

- **IMPORTANT:** When affixing the shipping label to the shipping box do not obstruct the bar code label.
- A completed SOA Warranty Parts Tag (MSA5W402A) must be attached to the returned inflator. The tag must contain the following information: claim number, repair date, full 17-digit VIN, and mileage.

Continued...

SOA PART RETURN NOTICE

- Upon claim approval, Subaru of America, Inc. will generate a Part Return Notice requesting information only.
- To ensure proper claim credit, the old and new inflator serial numbers must be recorded on the Part Return Notice and sent to SOA Part Collection Center (PCC) as instructed on the return notice.
- The completed Part Return Notice should then be sent using the YRC web portal and utilizing the “Ship Small Parcel” link which will direct the user to the appropriate UPS web page application to complete the shipment. Please keep the UPS tracking number for your records.
- **DO NOT WAIT FOR TAKATA XPO TO PICK UP THE PART TO SEND THIS INFORMATION TO THE PCC.**

Under no circumstances should the air bag inflator be sent to Subaru of America, Inc.

SERVICE PROCEDURE

This Campaign involves the replacement of the inflator portion of the passenger-side front airbag assembly. The subject inflators could have been assembled with improperly manufactured propellant components which may affect how the assembly inflates in the event of a collision resulting in an increased risk of injury to vehicle occupants. This procedure will outline removal of the passenger-side airbag assembly and replacement of the inflator component and related wiring harness.

VERY IMPORTANT: Failure to follow these service procedures carefully and correctly may result in an accidental deployment of the inflator and potentially cause serious injury. Please read through and understand these procedures COMPLETELY before beginning repairs. In addition, proper operation of the airbag after reassembly may be compromised if these service procedures are not followed.

TABLE OF CONTENTS – SERVICE PROCEDURES

Description	Starting Page Number
Service Procedure for 2005-2008 Legacy/Outback Models	8
Service Procedure for 2003-2004 Legacy/Outback and Baja Models	18
Service Procedure for 2004-2005 Impreza, WRX, and STI Models, Inflator Type 1, part number <u>98279FE000</u>	25
Service Procedure for 2004-2005 Impreza, WRX, and STI Models, Inflator Type 2, part number <u>98279FE070</u>	31

Continued...

Tools Required

DESCRIPTION	BRAND OR TYPE	QUANTITY
Pliers	-	1
Wire Cutters	-	1
Needle-Nose Pliers	-	1
Torque Wrench	Inch-Pound	1
Safety Goggles	-	1
Flat-Blade Screwdriver	-	1
Scissors	-	1
Ratchet	1/4" Drive	1
8 mm and 10 mm Socket		1 ea,
Airbag Deployment Fixture	J-39401-B	1

NOTE: Although the service procedure is similar for Legacy / Outback / Baja and Impreza models, there are some significant differences. For this reason, procedures for each model will be outlined.

CAUTION: Before starting this service procedure, perform a visual inspection of both front airbags looking for any damage or abnormality. Next, turn the ignition switch to the “ON” position and confirm the airbag warning lamp illuminates then extinguishes normally. If it does not or if **ANY** concern is noted with the airbag system, **STOP** and report these findings to the customer **BEFORE** proceeding further. Any concerns identified with the airbag system (when no airbag deployment has occurred), are not related to this campaign and must be addressed separately. Even if the system has a concern, this may not preclude completion of this campaign. If you are unsure about proceeding, document and fully diagnose the concern then contact the SOA Technical Helpline to review your findings. It is in the best interest of the retailer to fully document any concerns found during this preliminary inspection and review with the customer **BEFORE** proceeding with the campaign service procedure.

- **Vehicles that do not contain Genuine Subaru air bags are not eligible for this recall repair.** For more information on identifying counterfeit air bags and how to address related customer situations, please refer to STIS for the “Counterfeit Air Bag Information” Dealer Advisory Bulletin dated October 25, 2012 by going to [Subarunet>Service>STIS>Online Reference](#) - choose Publication Type: ‘Other/Miscellaneous’ and search keywords: ‘Air Bag’).
- **Do not proceed with this repair if your inspection reveals a non-Genuine Subaru air bag module has been installed in the vehicle.** Follow the instructions described in the “Counterfeit Air Bag Information” Dealer Advisory Bulletin and contact the SOA Warranty Helpline to close out the WQL-48 recall coverage on the vehicle.
- **IMPORTANT:** Always examine airbag modules closely before and during removal. Confirm they match the photos of the Genuine Subaru airbag components supplied throughout this bulletin **BEFORE** proceeding. The photos below are just 2 examples of aftermarket or counterfeit airbag components identified by retailers since the release of this campaign bulletin. These photos are being provided as only 2 examples of what may be a wide variety of non-OEM components.
- If an aftermarket or counterfeit passenger airbag or inflator is identified at any point during the campaign service procedure, **STOP IMMEDIATELY. NEVER attempt to remove or otherwise disable any aftermarket or counterfeit device.**

Continued...

- Document the presence of the aftermarket or counterfeit device on the repair order and with photos. Report this information immediately on a Quality Monitoring Report (QMR).
- Once the QMR has been submitted, contact the Subaru Claims Helpline to discuss the details. They will advise you on how to proceed with treatment of the open campaign.



The shape, holes, and copper-colored stud indicate this not a Genuine Subaru inflator.

No visible stopper plates, a 6-nut configuration and rubber harness boots are other examples to indicate this is not a Genuine Subaru airbag module.

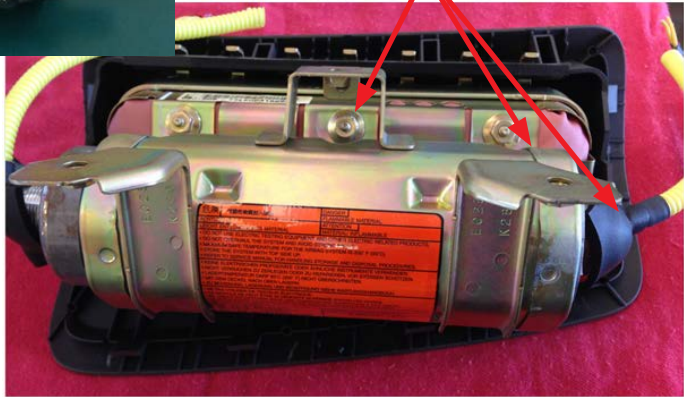

SERVICE PROCEDURE FOR 2005-2008 MY LEGACY / OUTBACK MODELS

CAUTION: Refer to the “CAUTION” section in the General Description portion of Airbag System AB in the Body Section of the Service Manual before handling or servicing any airbag module!

STEP 1- PREPARATION:

- Turn the ignition “OFF”.
- Disconnect the Negative (ground) cable from the battery and wait at least 20 seconds before proceeding further.
- Follow the procedures in the applicable Service Manual for removing the instrument panel assembly as required to access the passenger side airbag module.
- Disconnect the wiring harness and remove the airbag module.
- Secure the airbag module to the Airbag Deployment Fixture (part number J-39401-B) as shown in the photo below.

IMPORTANT: Whenever beginning to remove (or install) the airbag assembly, and periodically while performing the procedure or after stepping away, remove any possible static charge from your body by momentarily touching a clean, bare metal ground point on the vehicle (e.g. the door striker). Remove from your person all electronic devices including cell phones before proceeding.

IMPORTANT: DO NOT destroy or damage the Kit Box as it MUST be used for the original inflator’s return shipping.

Open the Kit Box and confirm all the necessary components are included

- 4 Self-Locking nuts
- New Inflator (yellow tape applied to one end to identify it as the replacement part)
- New Inflator Harness
- Electro-Tap (red shorting crimp connector)
- New Stopper Plate with D-Shaped hole
- Self-Adhesive Foam Protector
- Shipping Documentation



Continued...

To access the passenger's airbag module, the complete instrument panel assembly must be removed. Follow the procedures in the applicable Service Manual for removing the instrument panel assembly in addition to the necessary related interior trim components.

NOTE: When removing the "A" pillar trim, be **VERY CAREFUL** not to damage the upper metal retaining clip. The clip is located just below where the trim panel meets the head liner. If the metal retaining clip becomes damaged or separated from the trim panel, the trim panel **MUST** be replaced as the clip is not available separately. Use a plastic trim tool to push and release the upper portion of the metal clip from the body. Be careful to not pull the trim panel open any further than necessary to gain access for releasing the clip. There is a plastic retaining clip in the lower portion of the trim panel which will release easily once the upper retaining clip is loose. At reassembly and using a plastic trim tool, make sure the inner lip of the door weatherstrip overlaps the outer fabric edge of the trim panel to help secure it.

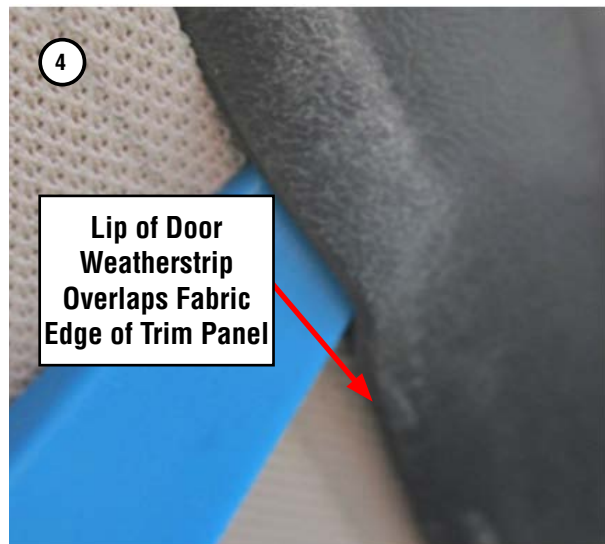
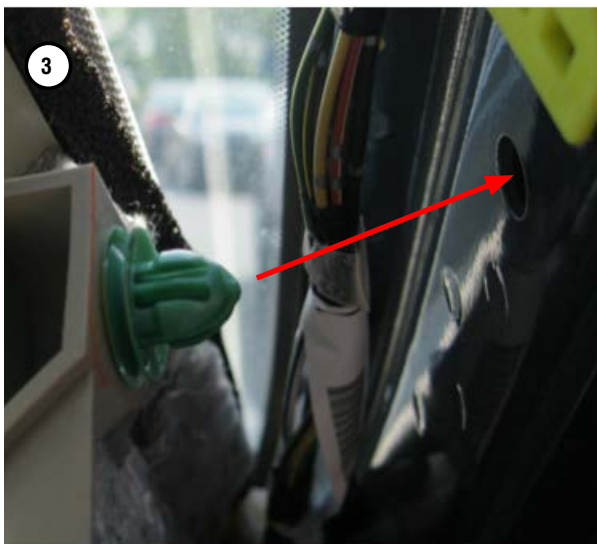
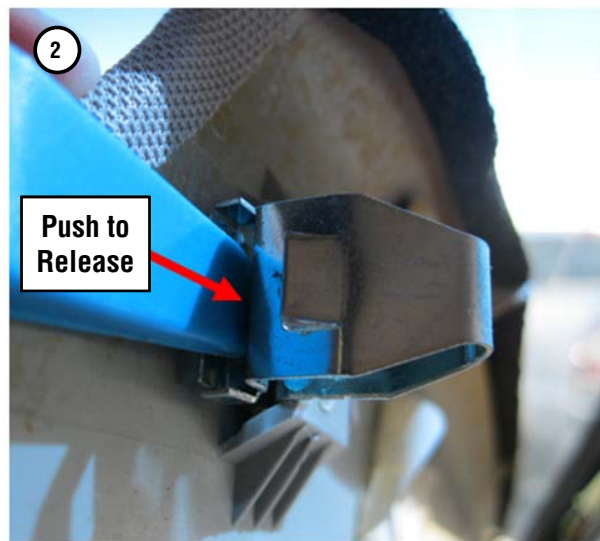
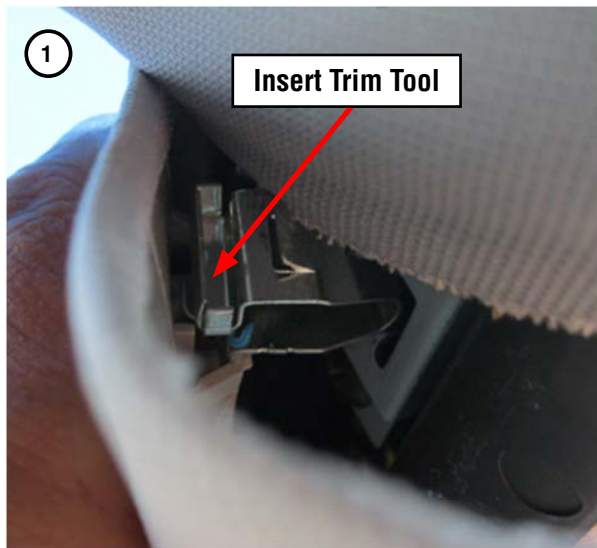

Once the instrument panel assembly has been removed from the vehicle, **CAREFULLY** separate the airbag module from it.

IMPORTANT: The removed airbag module must be mounted to the Airbag Deployment Fixture (part number J-39401-B) as shown in the photo below to better secure it during the inflator and wiring harness component replacement procedures. When mounting the module to the fixture, pay close attention to the harness routing as shown in the photo below. Always perform this work in an area away from others to reduce chances of inadvertent injury should any deployment occur. Take your surroundings into account to avoid possible hazards should inadvertent deployment occur or sources of static or other electricity that could potentially induce such a deployment.

STEP 2- Remove both sides of the harness from the retainer bracket holders then secure the airbag module to the Airbag Deployment Fixture as shown in the photos below.

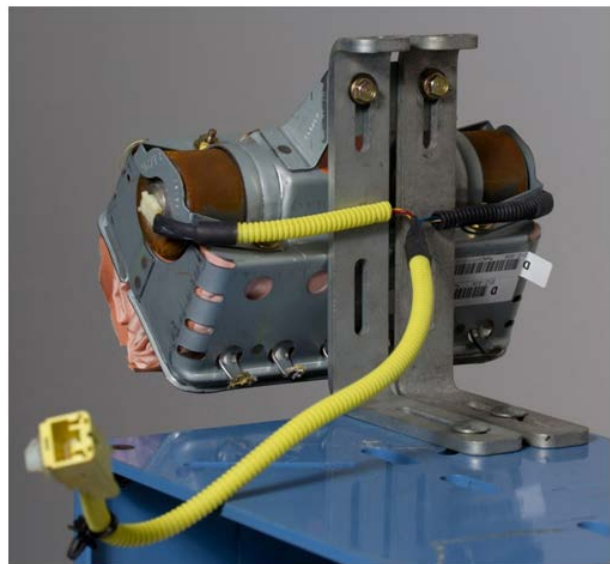
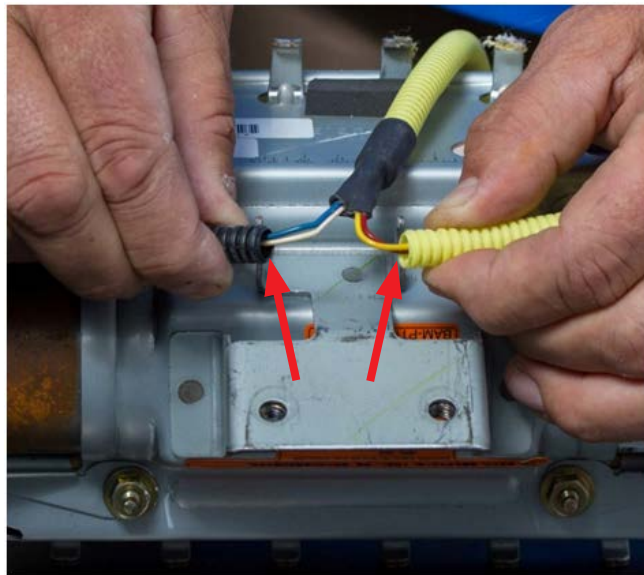

STEP 3- CAREFULLY cut the yellow harness cover (approximately 1 1/2 inches) enough to expose the 2 yellow and red wires inside and provide enough room to install the Electro-Tap (shorting) connector using a scissor or wire cutter (no knives or razors).

TAKE YOUR TIME AND BE CAREFUL TO NOT CUT THE 2 WIRES!

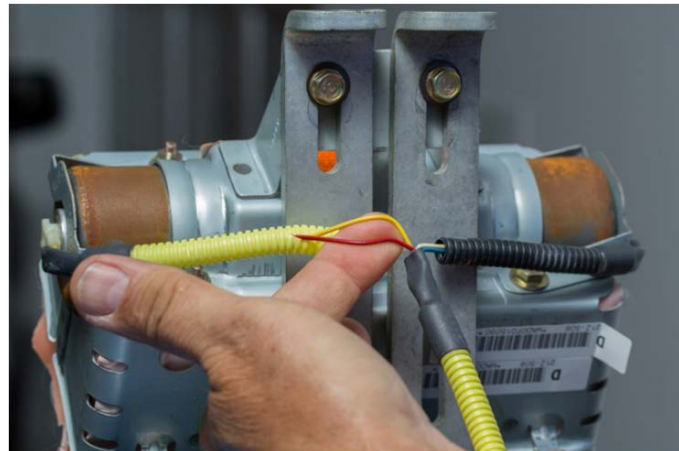

STEP 4- Short the yellow and red wires together by installing the Electro-Tap connector. The connector creates a short circuit which acts as a safeguard to prevent against static discharge that may deploy the removed inflator. The tab portion of the Electro-Tap connector **MUST** be cut off prior to use to insure a good short-circuit is made as shown in the illustration below. **Follow the sequence below** for installing the Electro-Tap connector. Use pliers to squeeze closed the two sections of the connector together, **one section at a time**.

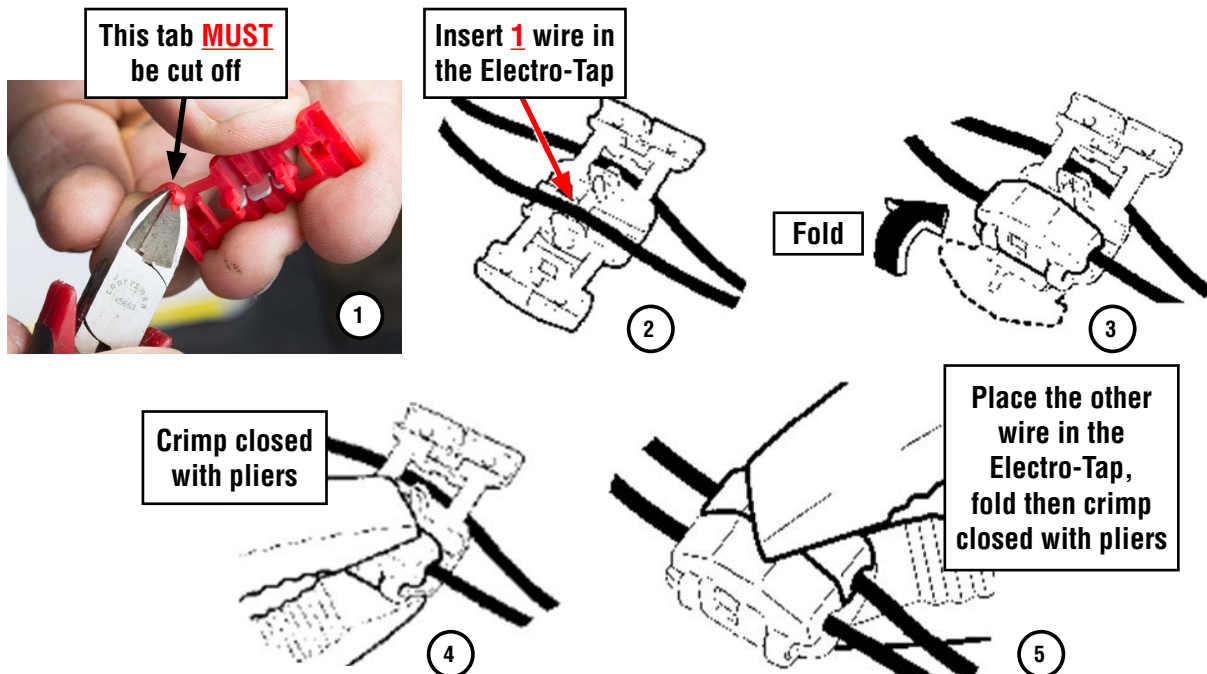

Continued...

STEP 5- Once the Electro-Tap connector is fully crimped in place, cut the yellow and red wires on the **body harness connector side** of the Electro-Tap connector as shown below.

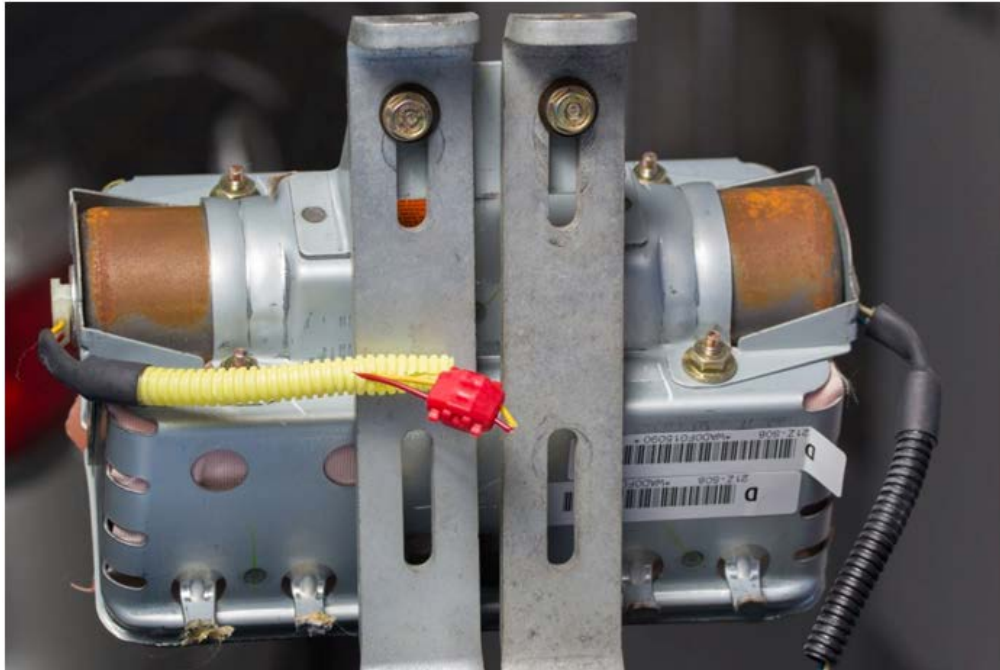

STEP 6- Loosen but **do not remove** the two 10mm self-locking nuts securing the stopper plate securing the end of the inflator with the blue and white wires as leaving them in place will help keep the airbag assembly together. Remove the two nuts and the stopper plate on the opposite end of the inflator mounting bracket and discard them. **NEVER ATTEMPT TO REMOVE THE HARNESS CONNECTORS FROM THE INFLATOR!** With the stopper plate removed and the other 2 self-locking nuts loosened, slide the original inflator out of the mounting bracket while feeding the cut off portion of the wiring harness under the remaining stopper plate. Place the removed original air bag inflator in the “cradle” of the Kit Box insert.

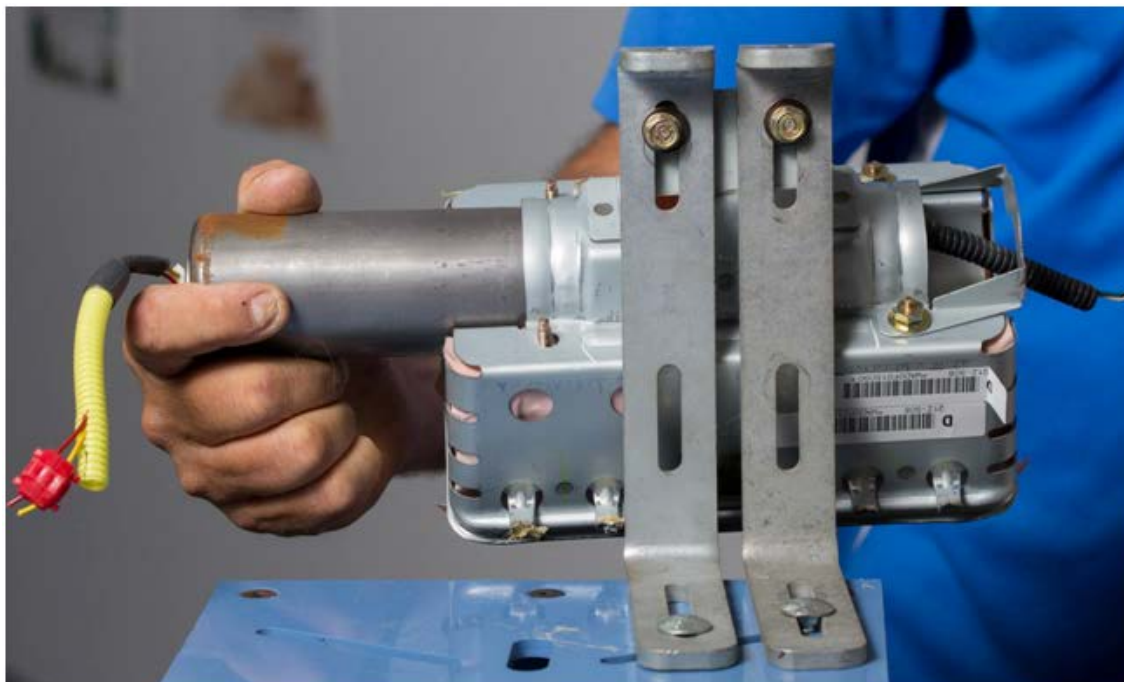

STEP 7 - VERY IMPORTANT: Record the **11-digit alpha-numeric serial number** for both the new and the removed inflators on the hard copy of the Repair Order. This information will be required for completion of the Part Return Notice which will be forwarded by the retailer to the PCC.



STEP 8- Install the new inflator into the mounting bracket so the yellow taped end aligns with the stopper plate still installed on the mounting bracket. Make sure the “D-shaped” portion of the inflator harness connector boss aligns with the “D-shaped” portion of the hole in the new replacement stopper plate as shown below. Do not peel the white harness connection dust cover at this time. Use 2 NEW self-locking nuts to secure the new stopper plate but do not fully tighten them. Remove the other 2 nuts securing the other stopper plate on the mounting bracket and replace them with 2 NEW self-locking nuts. When properly installed, both ends of the inflator will be seated tight against both stopper plates with no gaps.

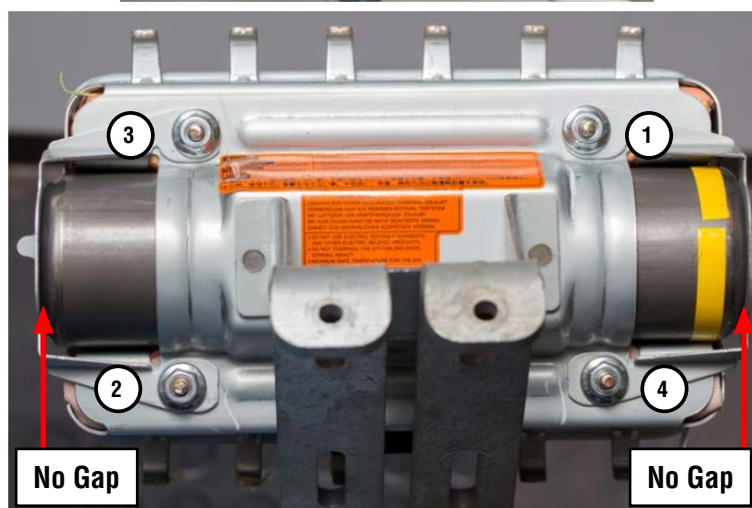
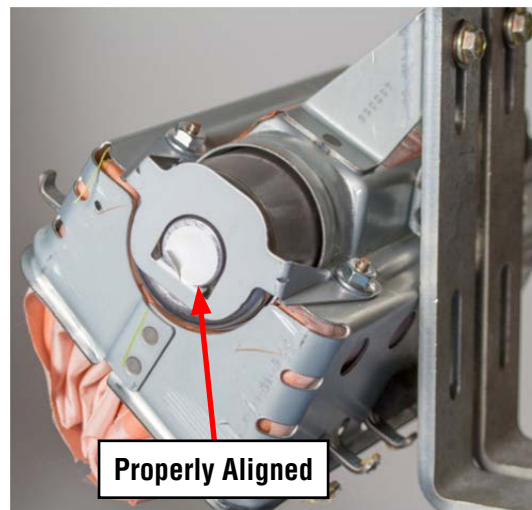

Continued...

STEP 9- Once all 4 **NEW** nuts are in place, **torque to 31 - 38 inch pounds in the sequence shown above.** Use a marker to mark the nuts after torquing to indicate they have been fully tightened.

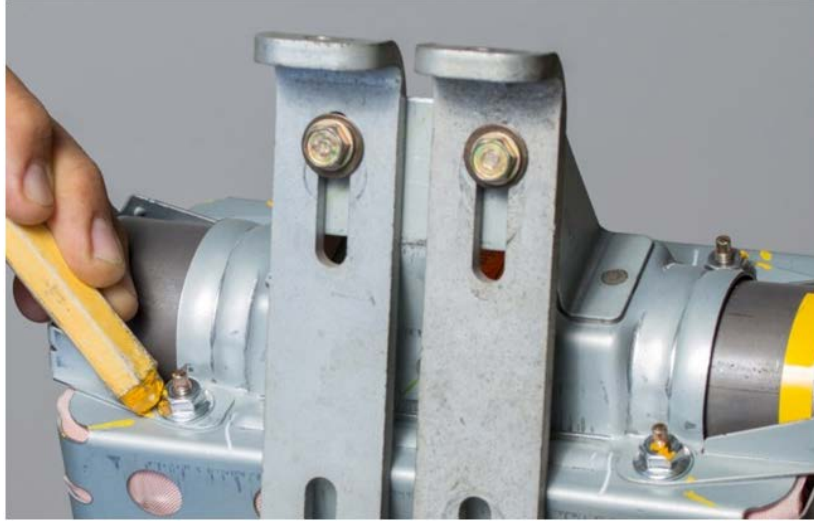

STEP 10- Install the black foam self-adhesive protector onto the D-Shaped stopper and mounting bracket positioned as shown in the photo sequence below. Once adhered in place on the new stopper plate, fold over the excess as shown. Always make sure the placement area for the protector is free of any grease or dirt before application.

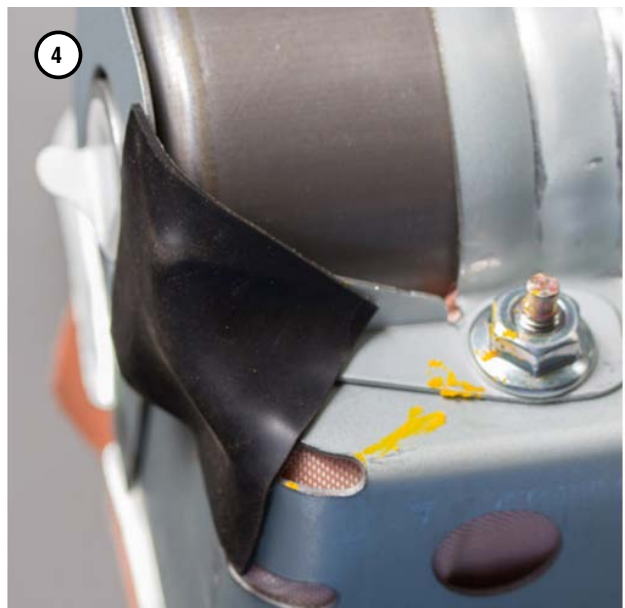
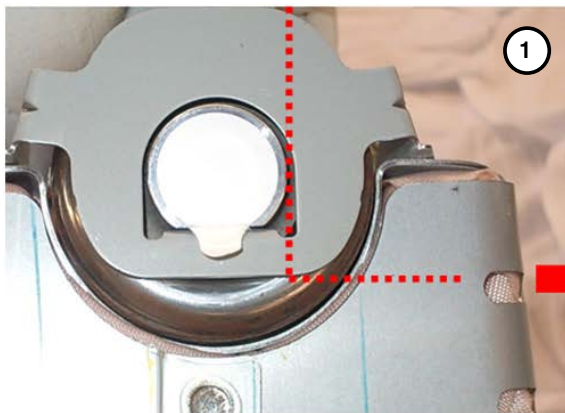

Continued...

STEP 11- The new inflator wiring harness has 2 “sides” with round 2-pin connectors on both ends. The side with the yellow corrugated tube and red / yellow wires will connect to the end of the inflator with the D-Shaped wiring harness connector boss, new stopper plate and foam protector as shown below. Peel off the white dust cover from the D-Shaped end of the inflator **ONLY**. **IMPORTANT: NEVER PEEL BOTH THE WHITE DUST COVERS OFF AT THE SAME TIME! CAREFULLY** align the pins with the female terminals of the harness connector (red / yellow wires) as shown in the photos below. Once pin alignment is confirmed, push down firmly to engage the connector’s 3 locking tangs into the locking groove inside the connector boss. Confirm the connector is locked by prying up **LIGHTLY** with a small flat-blade screwdriver. Repeat the procedure on the opposite end with the blue / white wires.

VERY IMPORTANT: When connecting the new harness to the inflator, both sides of the harness **MUST** be routed toward the module’s mounting brackets as shown in the photos below.

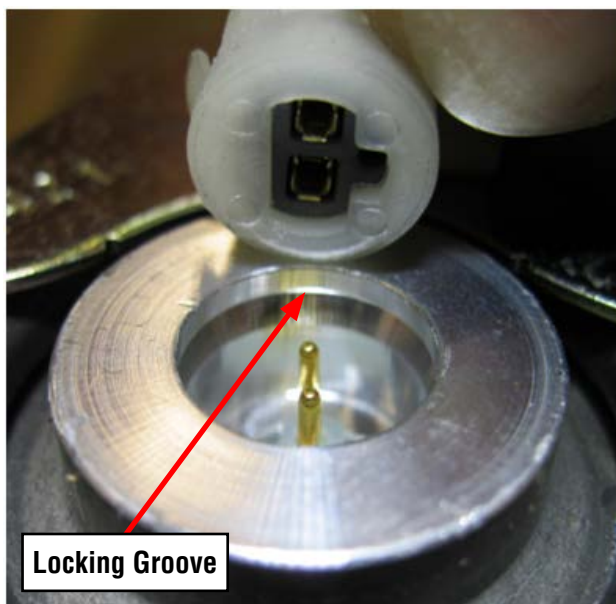

Continued...

STEP 12- Refit the ends of the harness corrugated tubes to the retaining grooves of the mounting bracket as shown to complete the airbag module reassembly.

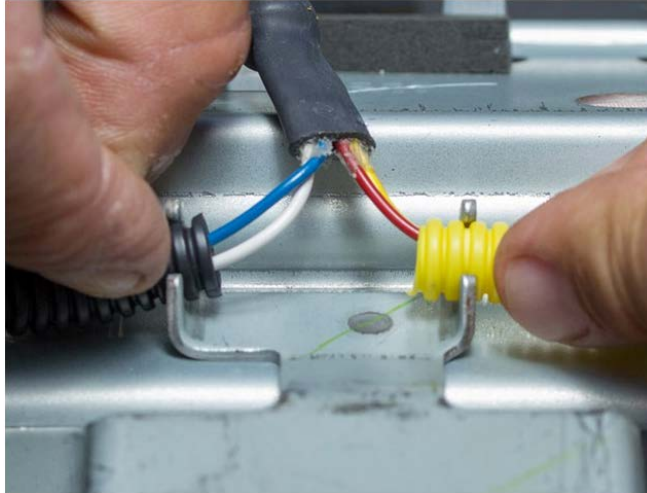

STEP 13- CAREFULLY reinstall the airbag module assembly into the instrument panel as shown below.



STEP 14- To eliminate a possible source of a rattling sound from the dash, wrap the 2 hooks and locator pin with non-woven material, p.n. SOA963W110 (or an equivalent self-adhesive foam) as shown below.

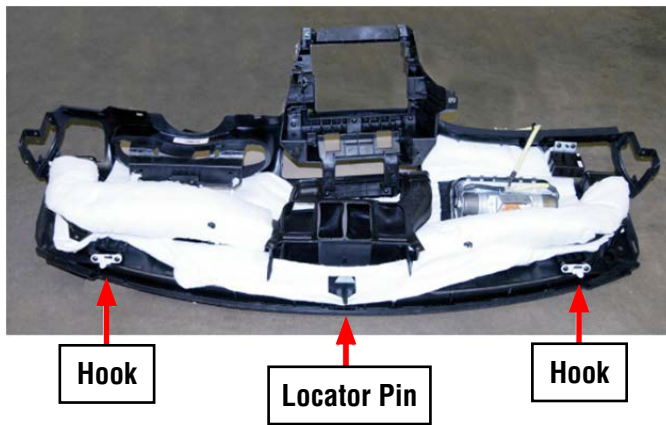

REMINDER: 1 sheet of the SOA963W110 non-woven material is enough for approximately 8 vehicles.

STEP 15- Reinstall the instrument panel assembly into the vehicle in reverse order of disassembly. Once the negative battery cable has been reconnected, turn the ignition key “ON” and confirm the AIRBAG warning light comes on then cycles off properly. Once proper warning light operation is confirmed, reinstall the remaining components to complete the procedure.

STEP 16- Place the removed original air bag inflator in the “cradle” of the Kit Box insert, with a completed SOA warranty parts tag (MSA5W402A) attached to it. The tag must contain the following information: **Claim Number, Repair Date, 17-digit VIN, and vehicle mileage.** Refer to the “PART RETURN PROCEDURES” section of this bulletin (page 4) for further return shipping instructions and information. **Ensure both the removed and installed inflator serial numbers have been recorded correctly as previously instructed on the repair order hard copy before returning the removed part to your Parts Department.**

IMPORTANT: UNDER NO CIRCUMSTANCES SHOULD ANY AIR BAG INFLATORS BE RETURNED TO SUBARU OF AMERICA, INC.

SERVICE PROCEDURE FOR 2003-2004 LEGACY / OUTBACK AND BAJA MODELS

CAUTION: Refer to the “CAUTION” section in the General Description portion of Airbag System AB in the Body Section of the Service Manual before handling or servicing any airbag module!

STEP 1- PREPARATION:

- Turn the ignition “OFF”.
- Disconnect the Negative (ground) cable from the battery and wait **at least 20 seconds** before proceeding further.
- Remove the glove box assembly following the procedure in the applicable Service Manual and using the tips below.

The glove box is held in place by 8 screws.

- o The 2 upper left and right hand corner screws have a distinctive gold finish and 10mm hex head. It is helpful to leave these 2 screws until last when removing and install first during replacement to support the weight of the assembly.
- o It is necessary to remove the knockout plugs (stopper in the Service Manual) to gain access to all the mounting screws.
- o It is possible to leave the stoppers in place during servicing by carefully bending in the sides of the glove box until the stoppers are cleared.
- To prevent damage, do not bend them in any further than necessary.
- **IMPORTANT: Whenever beginning to remove (or install) the airbag assembly, and periodically while performing the procedure or after stepping away, remove any possible static charge from your body by momentarily touching a clean, bare metal ground point on the vehicle (e.g. the door striker). Remove from your person all electronic devices including cell phones before proceeding.**
- Disconnect the airbag module harness connector (A) and release it from the support beam bracket.

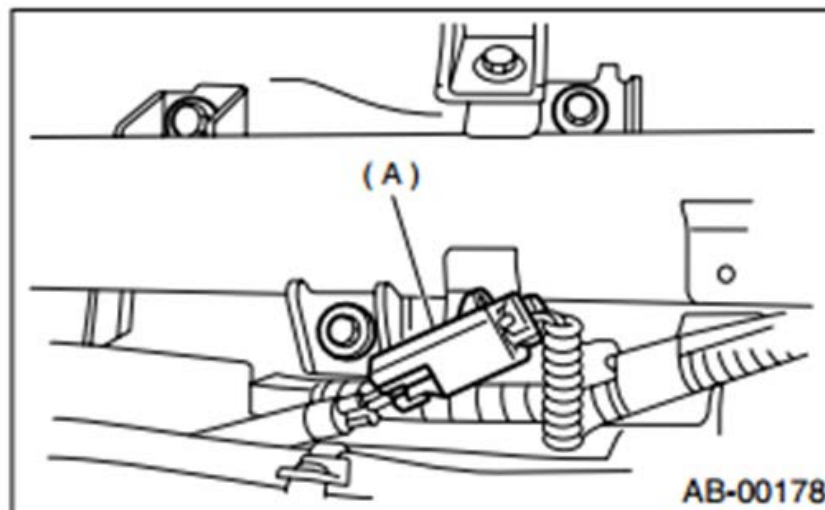

Continued...

- Remove the 3 retaining bolts and **CAREFULLY** remove the airbag module from the vehicle and place it on a clean cloth to protect the dash trim outer surface portion from damage.

IMPORTANT: DO NOT destroy or damage the Kit Box as it MUST be used for the original inflator's return shipping.

- Open the Kit Box and confirm all the necessary components are included:
 - 4 Self-Locking nuts
 - New Inflator (yellow tape applied to one end to identify it as the replacement part)
 - New Inflator Harness
 - Electro-Tap (red shorting crimp connector)
 - Shipping Documentation and Instructions



- **IMPORTANT: The removed airbag module must be mounted to the Airbag Deployment Fixture (part number J-39401-B) as shown in the photo below to better secure it during the inflator and wiring harness component replacement procedures.** When mounting the module to the fixture, pay close attention to the harness routing as shown in the photo below. Always perform this work in an area away from others to reduce chances of inadvertent injury should any deployment occur. Take your surroundings into account to avoid possible hazards should inadvertent deployment occur or sources of static or other electricity that could potentially induce such a deployment.



STEP 2- Remove the harness clip from the retainer bracket by rotating the harness / clip 90 degrees then releasing it from the bracket with needle-nose pliers.

STEP 3- CAREFULLY cut the yellow harness cover (approximately 1 1/2 inches) enough to expose the 2 yellow wires inside and provide enough room to install the Electro-Tap (shorting) connector using a scissor or wire cutter (no knives or razors). **TAKE YOUR TIME AND BE CAREFUL TO NOT CUT THE 2 YELLOW WIRES!**



STEP 4- Short the 2 yellow wires together by installing the Electro-Tap connector. The connector creates a short circuit which acts as a safeguard to prevent against static discharge that may deploy the removed inflator. The tab portion of the Electro-Tap connector **MUST** be cut off prior to use to insure a good short-circuit is made as shown in the illustration below. **Follow the sequence below** for installing the Electro-Tap connector. Use pliers to squeeze closed the two sections of the connector together, **one section at a time**.

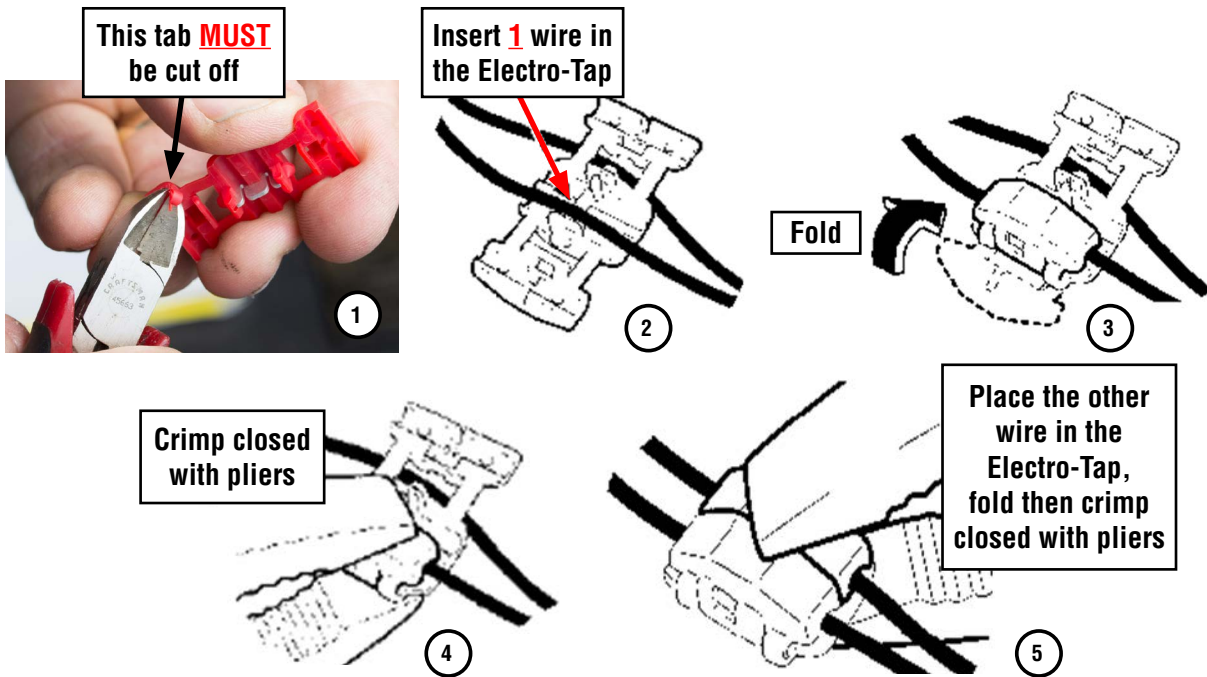

STEP 5- Once the Electro-Tap connector is fully crimped in place, cut the 2 yellow wires on the **body harness connector side** of the Electro-Tap connector.

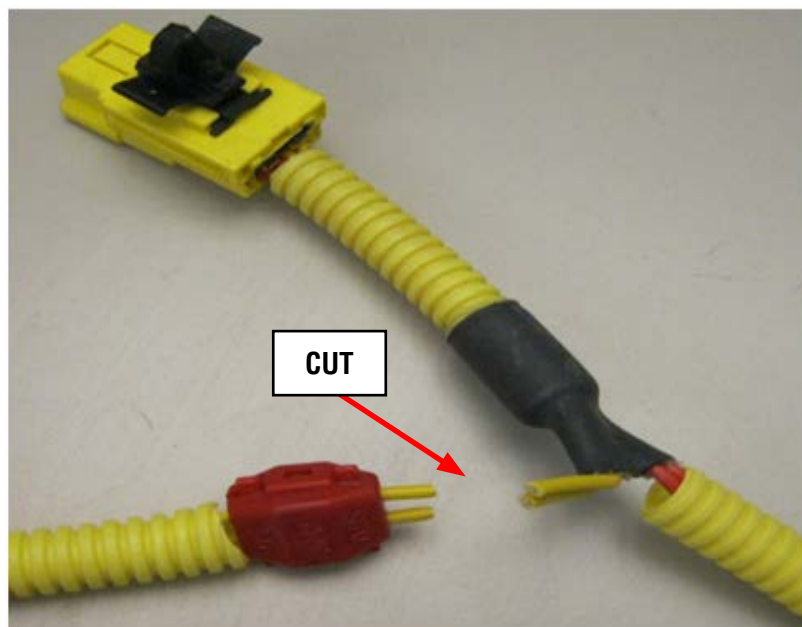

STEP 6- Remove the two 8mm self-locking nuts securing the stopper plate. Loosen but **do not remove** the other two nuts on the mounting bracket as leaving them in place will help keep the airbag assembly together.

NEVER ATTEMPT TO REMOVE THE HARNESS CONNECTORS FROM THE INFLATOR!

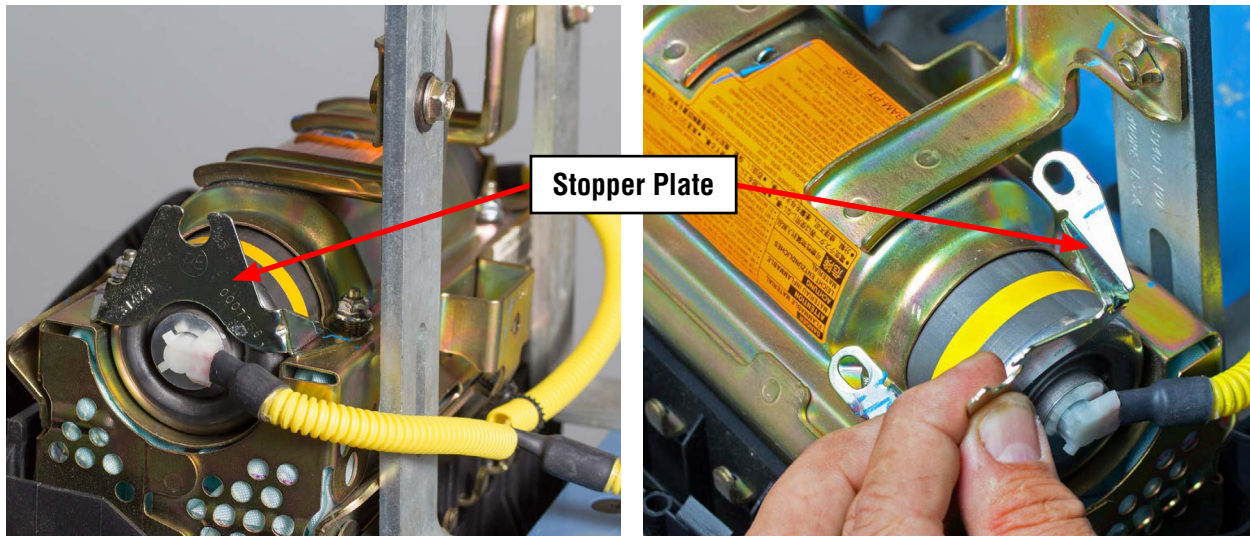

STEP 7- With the stopper plate removed and the other 2 self-locking nuts loosened, unseat the inflator off the mounting bracket end plate then rotate it slightly **CLOCKWISE** to make it easier to remove as shown below. Slide the original inflator out of the mounting bracket while feeding the cut off portion of the wiring harness through the “D-Shaped” hole in the end plate.

NEVER ATTEMPT TO REMOVE THE HARNESS CONNECTORS FROM THE INFLATOR! Place the removed original air bag inflator in the “cradle” of the Kit Box insert.

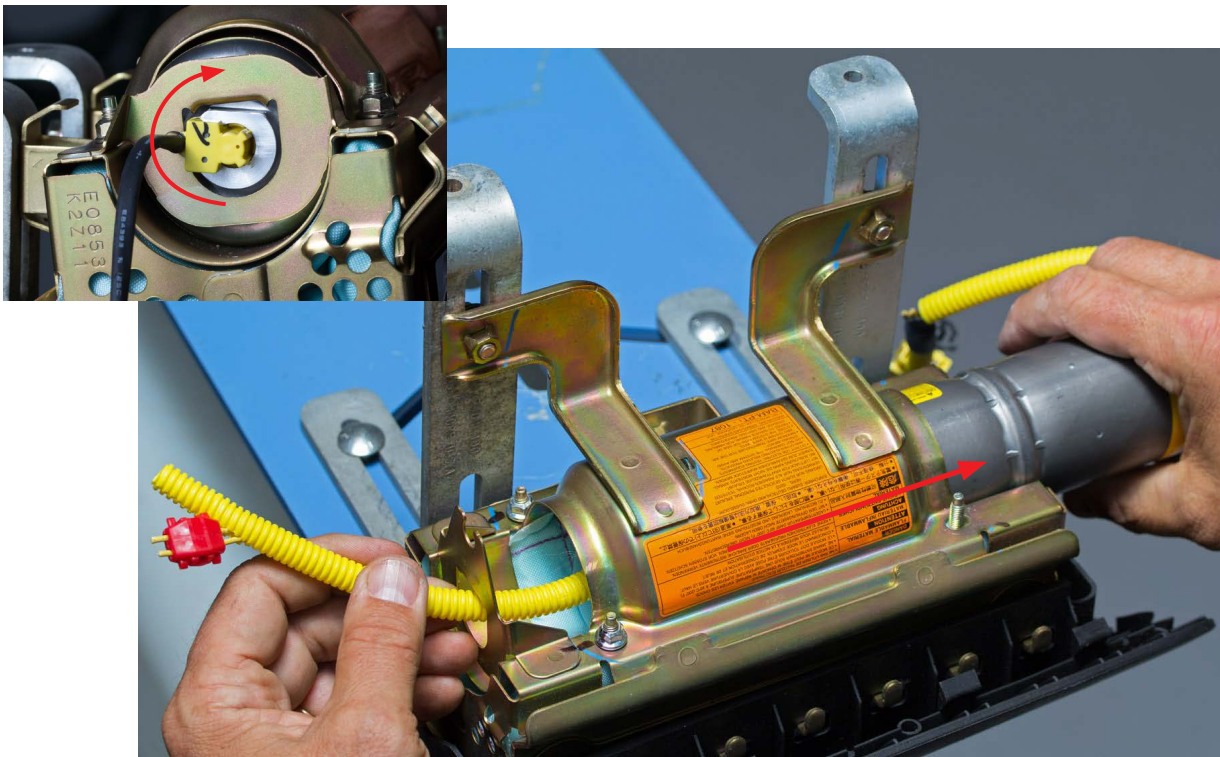

Continued...

STEP 8- VERY IMPORTANT: Record the **11-digit alpha-numeric serial number** for both the new and the removed inflators on the hard copy of the Repair Order. This information will be required for completion of the Part Return Notice which will be forwarded by the retailer to the PCC.



STEP 9- Install the new inflator into the mounting bracket so the yellow taped end aligns with the removed stopper plate. Make sure the “D-shaped” portion of the inflator harness connector boss aligns with the “D-shaped” portion of the hole in the end of the mounting bracket as shown below. When properly installed, the end of the inflator will be seated tight against the mounting bracket. Do not peel the white harness connection dust cover at this time.

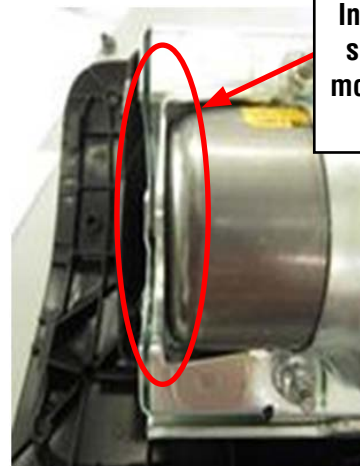

Inflator properly seated against mounting bracket (NO GAP)

STEP 10- As shown below, install but **do not fully tighten** 2 of the NEW self-locking nuts while holding the stopper plate tight against the inflator. Remove the nuts still installed on the mounting bracket and replace them with 2 NEW self-locking nuts. Once all 4 NEW nuts are in place, **torque to 31 - 38 inch pounds in the sequence shown below**. Use a marker to mark the nuts after torquing to indicate they have been fully tightened.

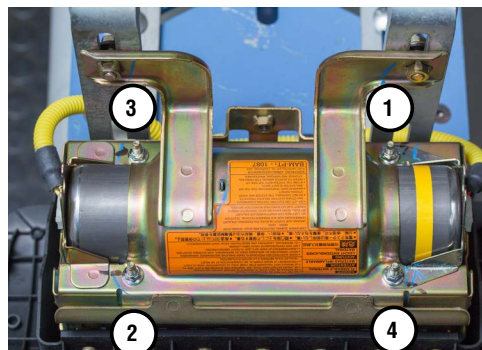

Continued...

STEP 11- The new inflator wiring harness has a “long side” and a “short side” with round 2-pin connectors on both ends. The short side with red wires will connect to the end of the inflator with the round wiring harness connector boss, yellow tape and removable stopper plate. **VERY IMPORTANT: When connecting the new harness to the inflator, both sides of the harness MUST be routed toward the module’s mounting brackets as shown in the photos below.**



Peel off the white dust cover from the round connector boss end of the inflator **ONLY**. **CAREFULLY** align the pins with the female terminals of the harness connector (2 red wires) as shown in the sequence below. **IMPORTANT: NEVER PEEL BOTH THE WHITE DUST COVERS OFF AT THE SAME TIME!** Once pin alignment is confirmed, push down firmly to engage the connector’s 3 locking tangs into the locking groove inside the connector boss. Confirm the connector is locked by prying up **LIGHTLY** with a small flat-blade screwdriver. Repeat the procedure on the D-shaped connector boss end (2 yellow wires). Reinstall the black wiring harness retaining clip into the mounting bracket to complete the airbag reassembly.

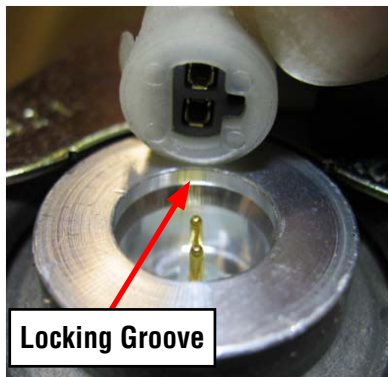

Locking Groove

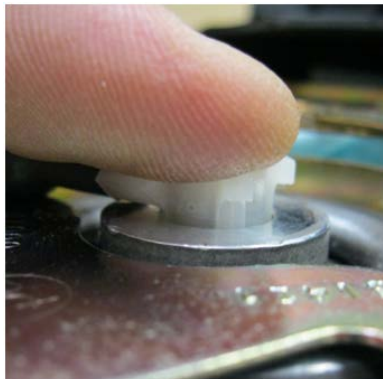

STEP 12- Reinstall the airbag assembly into the vehicle in reverse order of disassembly. Before installing the glove box assembly, reconnect the negative battery cable. Turn the ignition key “ON” and confirm the AIRBAG warning light comes on then cycles off properly. Once proper warning light operation is confirmed, reinstall the glove box assembly to complete the procedure.

STEP 13- Place the removed original air bag inflator in the “cradle” of the Kit Box insert, with a completed SOA warranty parts tag (MSA5W402A) attached to it. The tag must contain the following information: **Claim Number, Repair Date, 17-digit VIN, and vehicle mileage.** Refer to the “PARTS RETURN PROCEDURES” section of this bulletin (page 4) for further return shipping instructions and information. **Ensure both the removed and installed inflator serial numbers have been recorded correctly as previously instructed on the repair order hard copy before returning the removed part to your Parts Department.**

IMPORTANT: UNDER NO CIRCUMSTANCES SHOULD ANY AIR BAG INFLATORS BE RETURNED TO SUBARU OF AMERICA, INC.

- Refer to Page 39 for instructions on completing and installing the Recall Identification Label.

Continued...

SERVICE PROCEDURE FOR IMPREZA, WRX and STI MODELS, INFLATOR TYPE 1, P.N. 98279FE000

CAUTION: Refer to the “CAUTION” section in the General Description portion of Airbag System AB in the Body Section of the Service Manual before handling or servicing the airbag module!

STEP 1- PREPARATION:

- Turn the ignition “OFF”.
- Disconnect the Negative (ground) cable from the battery and wait **at least 20 seconds** before proceeding further.
- Remove the glove box assembly following the procedure in the applicable Service Manual.

IMPORTANT: Whenever beginning to remove (or install) the airbag assembly, and periodically while performing the procedure or after stepping away, remove any possible static charge from your body by momentarily touching a clean, bare metal ground point on the vehicle (e.g. the door striker). Remove from your person all electronic devices including cellphones before proceeding.

- Disconnect the airbag module harness connector from the support beam bracket.
- Remove the 3 retaining bolts and **CAREFULLY** remove the airbag module from the vehicle and place it on a clean cloth to protect the dash trim surface portion from damage.

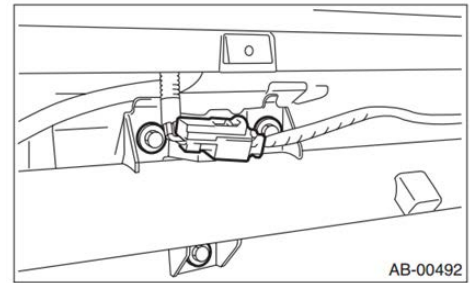

NOTE: There may be a Security Module secured with the lower airbag module mounting bolt on some models.

IMPORTANT: DO NOT destroy or damage the kit box as it MUST be used for the original inflator’s return shipping.

- Open the Kit Box and confirm all the necessary components are included:
 - 4 Self-Locking nuts
 - New **Type 1** Inflator (yellow tape applied to one end to identify it as the replacement part)
 - New Inflator Harness
 - Electro-Tap (red shorting crimp connector)
 - 1 ½” X 2 ¼” piece of self-adhesive Sponge Tape
 - Shipping Documentation and Instructions



Continued...

IMPORTANT: The removed airbag module must be mounted to the Airbag Deployment Fixture (part number J-39401-B) as shown in the photo below to better secure it during the inflator and wiring harness component replacement procedures. Always perform this work in an area away from others to reduce chances of inadvertent injury should any deployment occur. Take your surroundings into account to avoid possible hazards should inadvertent deployment occur or sources of static or other electricity that could potentially induce such a deployment.



STEP 2- Peel the Sponge Tape and remove the harness clip from the retainer bracket by pushing the tangs inward with a flat-blade screwdriver as shown below. Always remove any Sponge Tape adhesive residue from the airbag mounting bracket using mild solvent on a clean shop cloth. **CAUTION:** Never use any silicone-based products for this purpose.

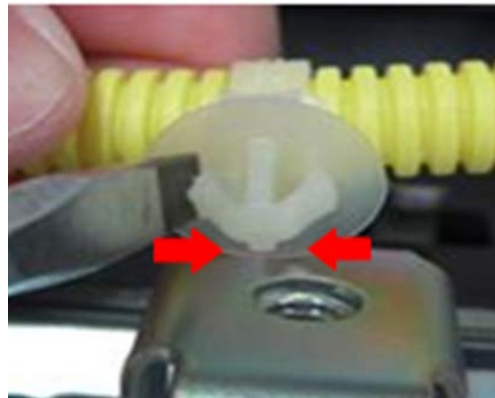

STEP 3- CAREFULLY cut the yellow harness cover enough (approximately 2 inches) to expose the 2 red (or yellow) wires inside and provide enough room to install the Electro-Tap (shorting) connector using a wire cutter or scissor (no knives or razors). **TAKE YOUR TIME AND BE CAREFUL TO NOT CUT THE 2 WIRES!**

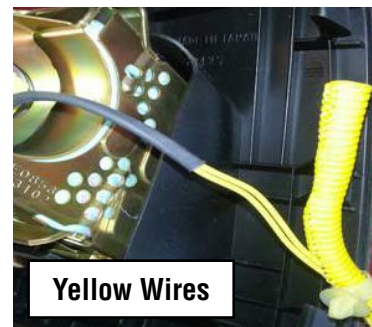
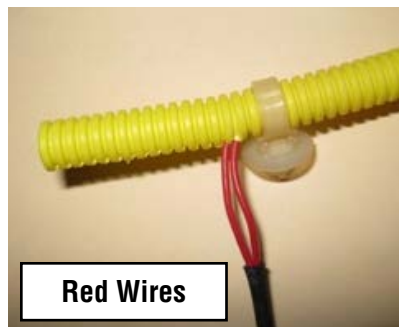

STEP 4- Short the 2 wires together by installing the Electro-Tap connector. The connector creates a short circuit which acts as a safeguard to prevent against static discharge that may deploy the removed inflator. The tab portion of the Electro-Tap connector **MUST** be cut off prior to use to insure a good short-circuit is made as shown in the illustration below. **Follow the sequence** below for installing the Electro-Tap connector. Use pliers to squeeze closed the two sections of the connector together, **one section at a time**.

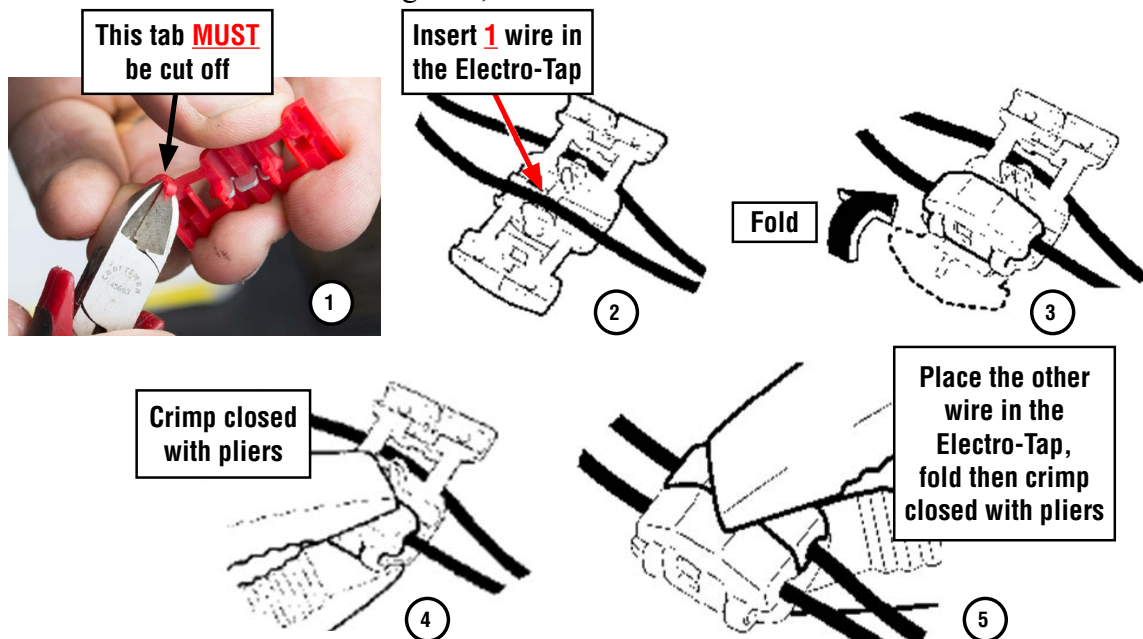

STEP 5- Once the Electro-Tap connector is fully crimped in place, cut the 2 wires on the **body harness connector side** of the Electro-Tap connector.

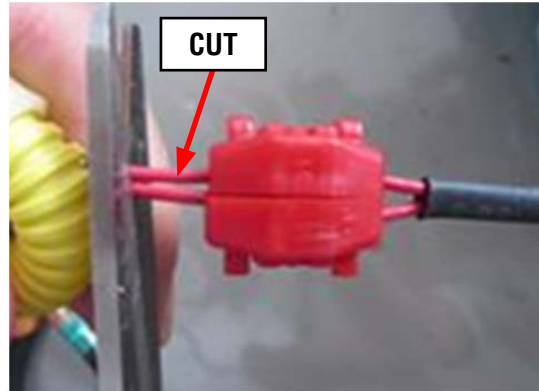

STEP 6- Remove the two 8mm self-locking nuts securing the stopper plate. Loosen but **do not remove** the other two nuts on the mounting bracket as leaving them in place will help keep the airbag assembly together.

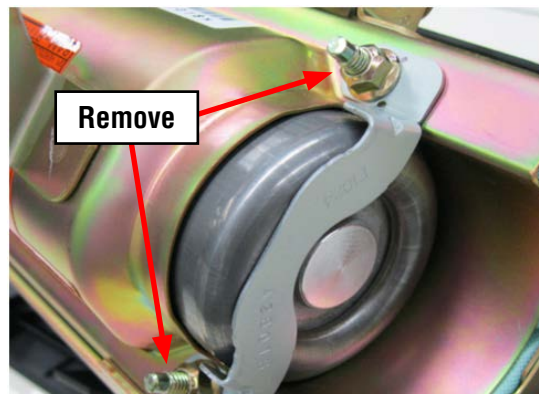

STEP 7- With the stopper plate removed and the other 2 self-locking nuts loosened, unseat the inflator off the mounting bracket end plate then rotate it slightly **CLOCKWISE** to make it easier to remove as shown in the photo to the right. Slide the inflator out of its mounting while feeding the cut off portion of the wiring harness through the “D-Shaped” hole in the end of the mounting bracket.

NEVER ATTEMPT TO REMOVE THE HARNESS FROM THE INFLATOR!

Place the removed original air bag inflator in the “cradle” of the Kit Box insert.



STEP 8- VERY IMPORTANT: Record the **11-digit alpha-numeric serial number** for both the new and the removed inflators on the hard copy of the Repair Order. This information will be required for completion of the Part Return Notice which will be forwarded by the retailer to the PCC. The new serial number is also a requirement for claim entry.



STEP 9- Install the new inflator into the mounting bracket with the harness connector end going in first toward the mounting bracket. Make sure the “D-shaped” portion of the inflator harness connector boss aligns with the “D-shaped” portion of the hole in the end of the mounting bracket as shown below. When properly installed, the end of the inflator will be seated tight against the mounting bracket. Do not peel the white harness connection dust cover at this time.

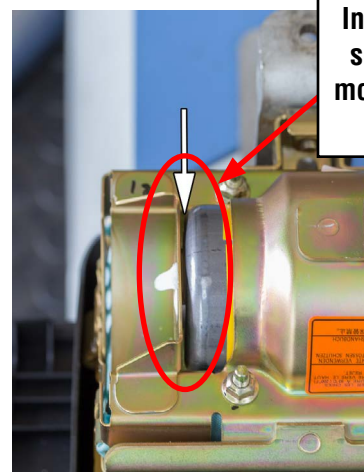
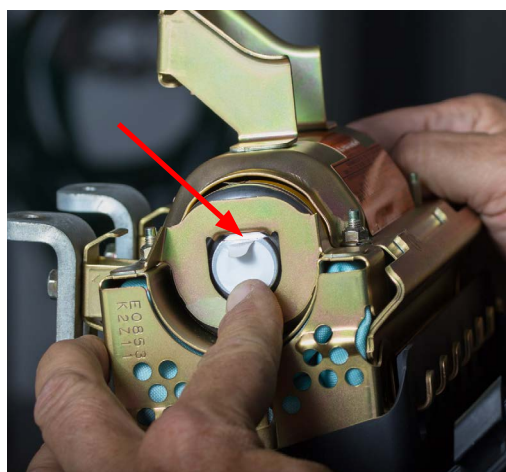

Inflator properly seated against mounting bracket (NO GAP)

Continued...

STEP 10- As shown below, install but do not fully tighten 2 of the NEW self-locking nuts while holding the stopper plate tight against the inflator. Remove the nuts still installed on the mounting bracket and replace them with 2 NEW self-locking nuts. Once all 4 NEW nuts are in place, torque to 31 - 38 inch pounds in the sequence shown below. Use a marker to mark the nuts after torquing indicating they have been fully tightened.

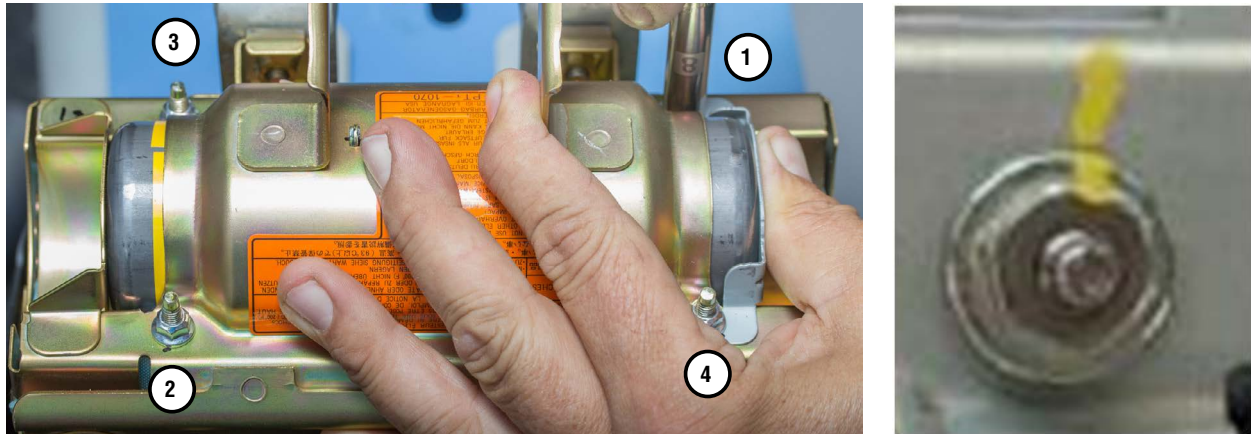

STEP 11- VERY IMPORTANT: When connecting the new harness to the inflator, the harness **MUST** be routed toward the module's mounting brackets as shown in the photo below. Peel off the white dust cover and **CAREFULLY** align the 2 inflator pins with the female terminals of the harness connector as shown in the sequence below. Once pin alignment is confirmed, push down firmly to engage the connector's 2 locking tangs into the locking groove of the connector boss. Confirm the connector is fully locked by prying up **LIGHTLY** with a small flat-blade screwdriver.

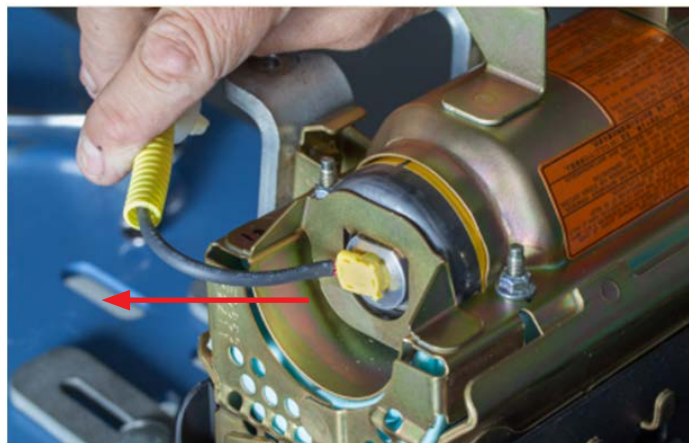

STEP 12- Reinstall the wiring harness retaining clip into its position on the mounting bracket.

Continued...

STEP 13- Peel the adhesive backing and install the new Sponge Tape onto the yellow harness tube first then adhere it to the airbag mounting bracket as shown in the illustrations below.

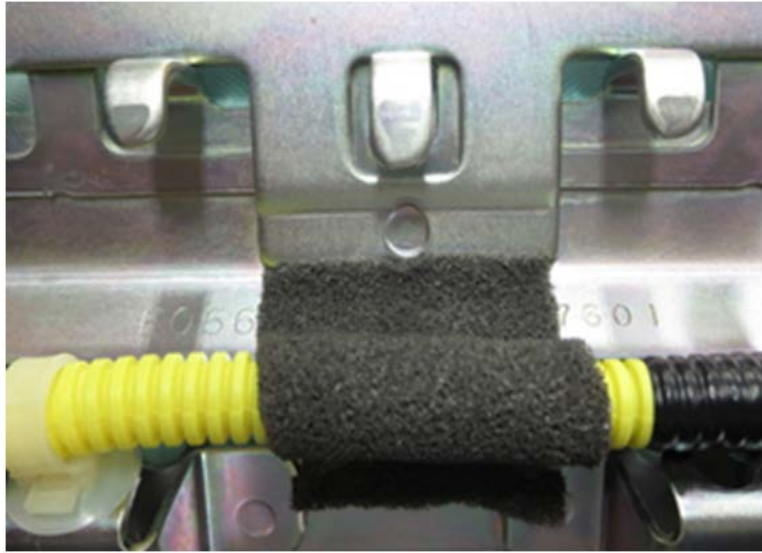

Placement of Sponge Tape

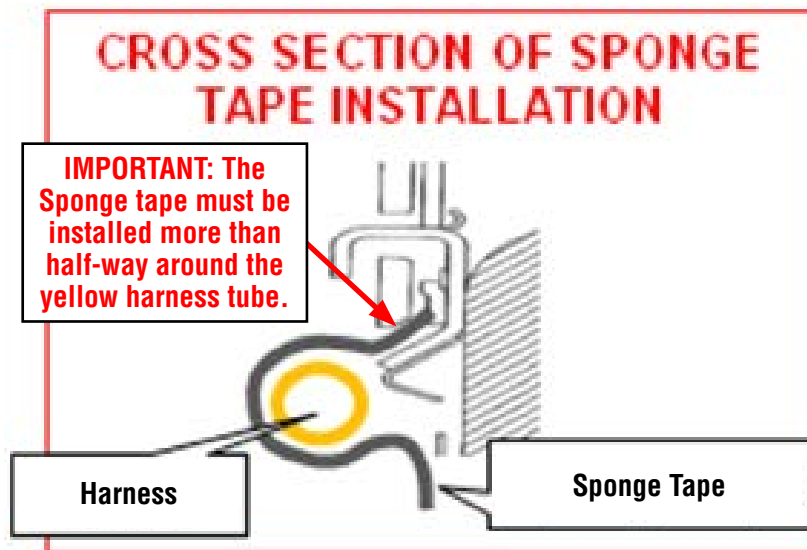

STEP 14- Reinstall the airbag assembly into the vehicle in reverse order of disassembly.
NOTE: If the accessory security module is installed to one of the airbag module mounting bolts, torque that specific bolt to 7.5 +/-1ft. lb. rather than the normal 5.4 ft. lb. specified in the Service Manual. Before installing the glove box assembly, reconnect the negative battery cable. Turn the ignition key “ON” and confirm the AIRBAG warning light comes on then cycles off properly. Once proper warning light operation is confirmed, reinstall the glove box assembly while making sure the cord loop for the opening dampener (if equipped) stays connected to complete the procedure.

STEP 15- Place the removed air bag inflator in the “cradle” of the Kit Box insert, with a completed SOA warranty parts tag (MSA5W402A) attached to it. The tag must contain the following information: **Claim Number, Repair Date, 17-digit VIN, and vehicle mileage.** Refer to the “PARTS RETURN PROCEDURES” section of this bulletin (page 4) for further return shipping instructions and information.

IMPORTANT: UNDER NO CIRCUMSTANCES SHOULD ANY AIR BAG INFLATORS BE RETURNED TO SUBARU OF AMERICA, INC.

Continued...

SERVICE PROCEDURE FOR IMPREZA, WRX AND STI MODELS, INFLATOR TYPE 2, P.N. 98279FE070

CAUTION: Refer to the “CAUTION” section in the General Description portion of Airbag System AB in the Body Section of the Service Manual before handling or servicing the airbag module!

STEP 1- PREPARATION:

- Turn the ignition “OFF”.
- Disconnect the Negative (ground) cable from the battery and wait **at least 20 seconds** before proceeding further.
- Remove the glove box assembly following the procedure in the applicable Service Manual.

IMPORTANT: Whenever beginning to remove (or install) the airbag assembly, and periodically while performing the procedure or after stepping away, remove any possible static charge from your body by momentarily touching a clean, bare metal ground point on the vehicle (e.g. the door striker). Remove from your person all electronic devices including cellphones before proceeding.

- Disconnect the airbag module harness connector from the support beam bracket.
- Remove the 3 retaining bolts and **CAREFULLY** remove the airbag module from the vehicle and place it on a clean cloth to protect the dash trim surface portion from damage.

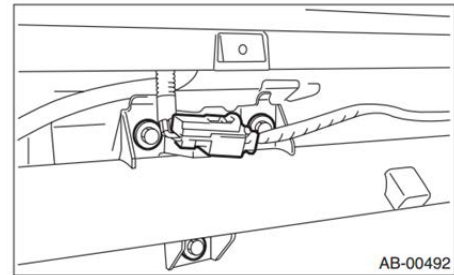

NOTE: There may be a Security Module secured with the lower airbag module mounting bolt on some models.

IMPORTANT: **DO NOT** destroy or damage the kit box as it **MUST** be used for the original inflator’s return shipping.

- Open the Kit Box and confirm all the necessary components are included:
 - 4 Self-Locking nuts
 - New **Type 2** Inflator (pink collars on each end identify it as the replacement part)
 - New Inflator Harness
 - New Stopper Plate**
 - Electro-Tap (red shorting crimp connector)
 - 1 ½” X 2 ¼” piece of self-adhesive Sponge Tape
 - Shipping Documentation and Instructions



Continued...

IMPORTANT: The removed airbag module must be mounted to the Airbag Deployment Fixture (part number J-39401-B) as shown in the photo below to better secure it during the inflator and wiring harness component replacement procedures. Always perform this work in an area away from others to reduce chances of inadvertent injury should any deployment occur. Take your surroundings into account to avoid possible hazards should inadvertent deployment occur or sources of static or other electricity that could potentially induce such a deployment.



STEP 2- Peel the Sponge Tape and remove the harness clip from the retainer bracket by pushing the tangs inward with a flat-blade screwdriver as shown below. Always remove any Sponge Tape adhesive residue from the airbag mounting bracket using mild solvent on a clean shop cloth. **CAUTION:** Never use any silicone-based products for this purpose.

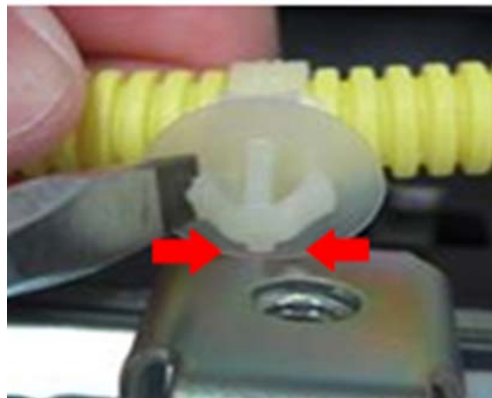

STEP 3- CAREFULLY cut the yellow harness cover enough (approximately 2 inches) to expose the 2 red (or yellow) wires inside and provide enough room to install the Electro-Tap (shorting) connector using a wire cutter or scissor (no knives or razors). **TAKE YOUR TIME AND BE CAREFUL TO NOT CUT THE 2 WIRES!**

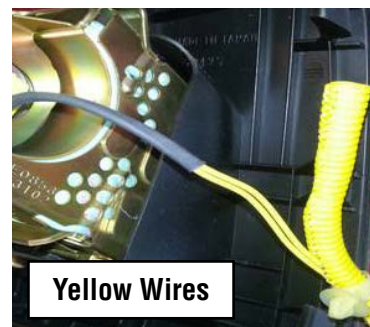
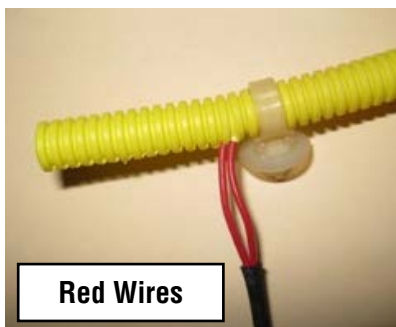

STEP 4- Short the 2 wires together by installing the Electro-Tap connector. The connector creates a short circuit which acts as a safeguard to prevent against static discharge that may deploy the removed inflator. The tab portion of the Electro-Tap connector **MUST** be cut off prior to use to insure a good short-circuit is made as shown in the illustration below. **Follow the sequence** below for installing the Electro-Tap connector. Use pliers to squeeze closed the two sections of the connector together, **one section at a time**.

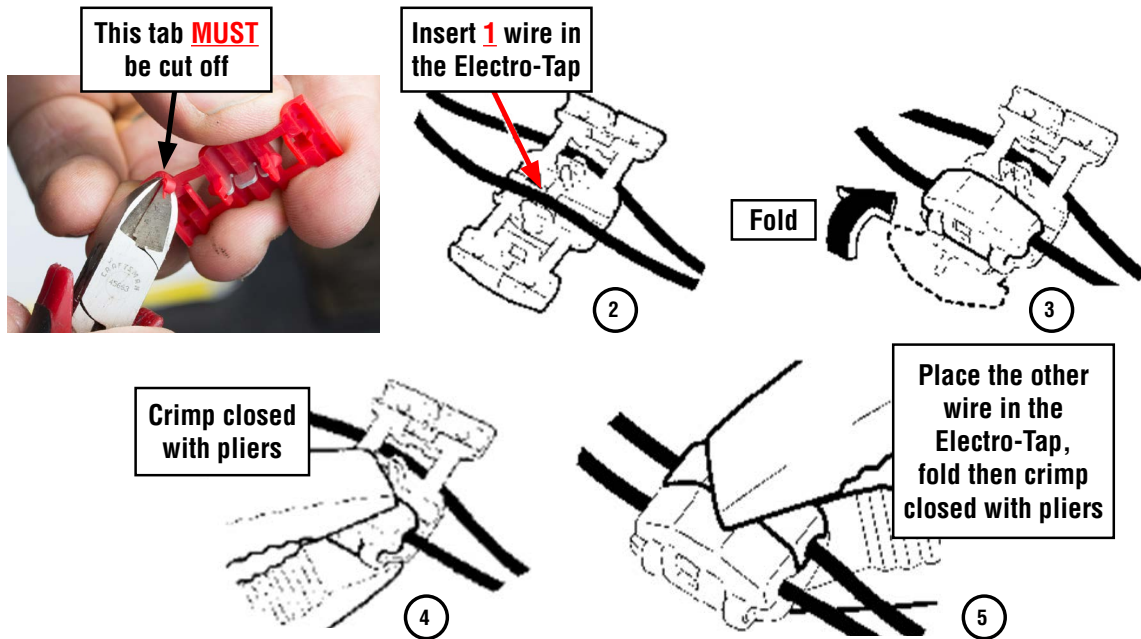

STEP 5- Once the Electro-Tap connector is fully crimped in place, cut the 2 wires on the **body harness connector side** of the Electro-Tap connector.

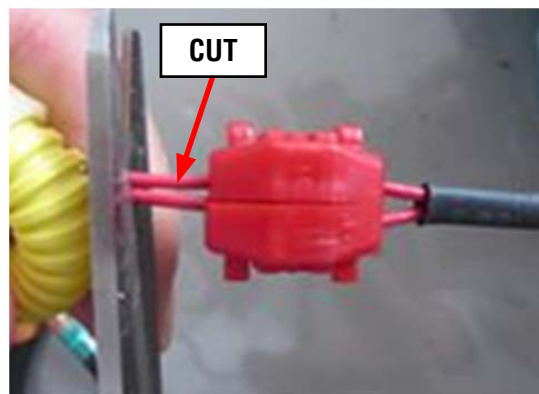

STEP 6- Remove the two 8mm self-locking nuts securing the stopper plate. Loosen but **do not remove** the other two nuts on the mounting bracket as leaving them in place will help keep the airbag assembly together.

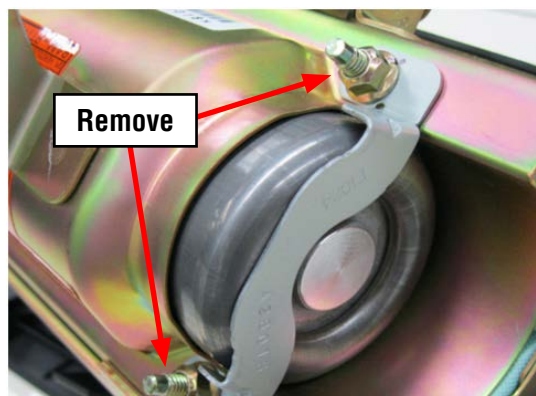

Continued...

STEP 7- With the stopper plate removed and the other 2 self-locking nuts loosened, unseat the inflator off the mounting bracket end plate then rotate it slightly **CLOCKWISE** to make it easier to remove as shown in the photo to the right. Slide the inflator out of its mounting while feeding the cut off portion of the wiring harness through the “D-Shaped” hole in the end of the mounting bracket.
NEVER ATTEMPT TO REMOVE THE HARNESS FROM THE INFLATOR!
 Place the removed original air bag inflator in the “cradle” of the Kit Box insert.



STEP 8- VERY IMPORTANT: Record the **11-digit alpha-numeric serial number for both the removed (Type 1) and 14-digit numeric serial number for the new (Type 2) inflator** on the Repair Order hard copy. This information will be required for completion of the Part Return Notice which will be forwarded by the retailer to the PCC. The new 14 digit numeric serial number is also a requirement for claim entry.



STEP 9- Inspect the new **Type 2** inflator to confirm the locating protrusions on each of the pink collar portions are aligned as shown below. The “short” collar can be rotated as needed to align it with the protrusion on the “long” collar if necessary.

NOTE: The **Type 2** inflator is installed in the opposite direction of the original. This change puts the connector on the other end. The new harness has been extended approximately 2” to compensate.

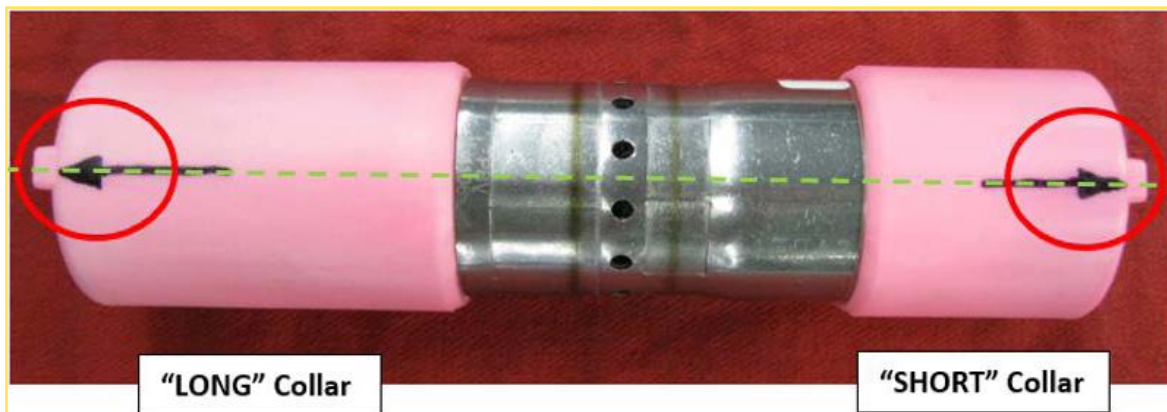

Continued...

STEP 10- Install the new inflator into the mounting bracket, short collar with the “blank” (no harness connector) end going in first. The protrusion on the short collar will fit in the gap at the bottom of the fixed stopper plate portion. At the same time, the ridge portion of the inflator side of the stopper plate will fit into the “notch” in the end of the collar. When properly installed, the end of the inflator will be seated tight against the mounting bracket with NO gap. DO NOT peel the white harness connection dust cover at this time.

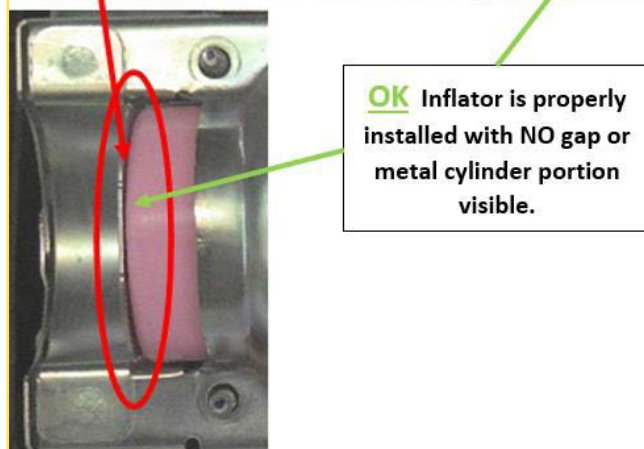
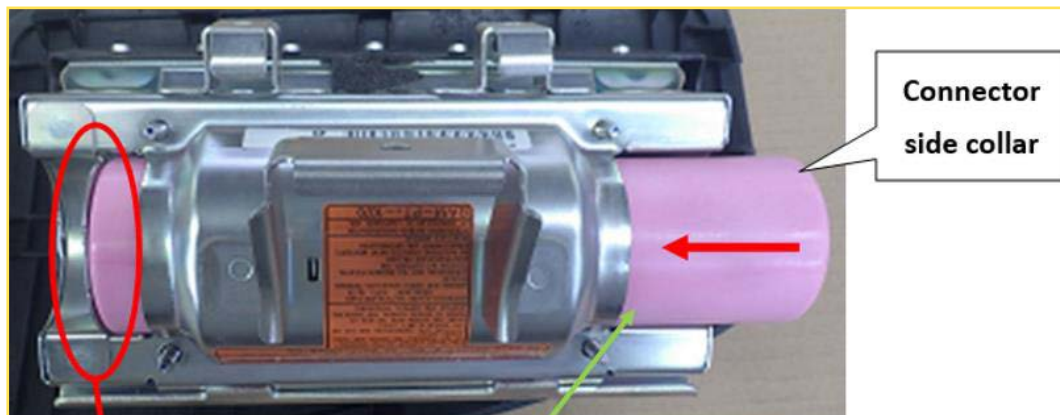
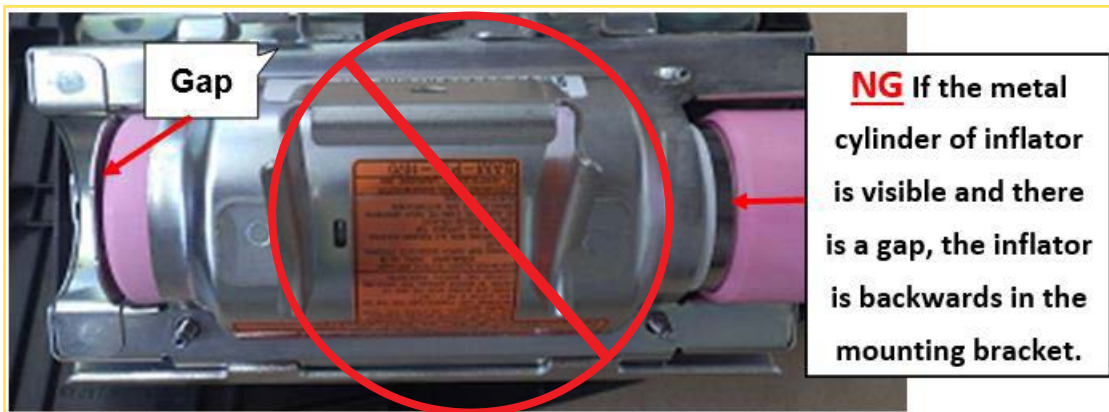
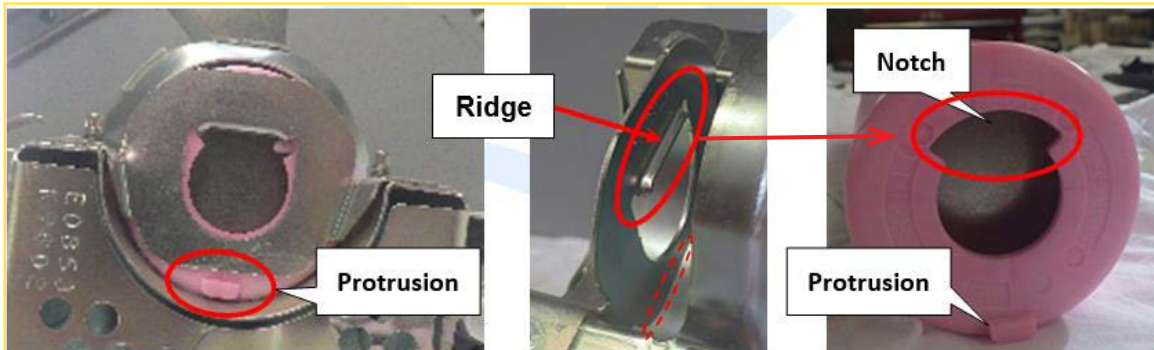

Continued...

STEP 11- Install the new stopper plate over the harness connector end of the new inflator.

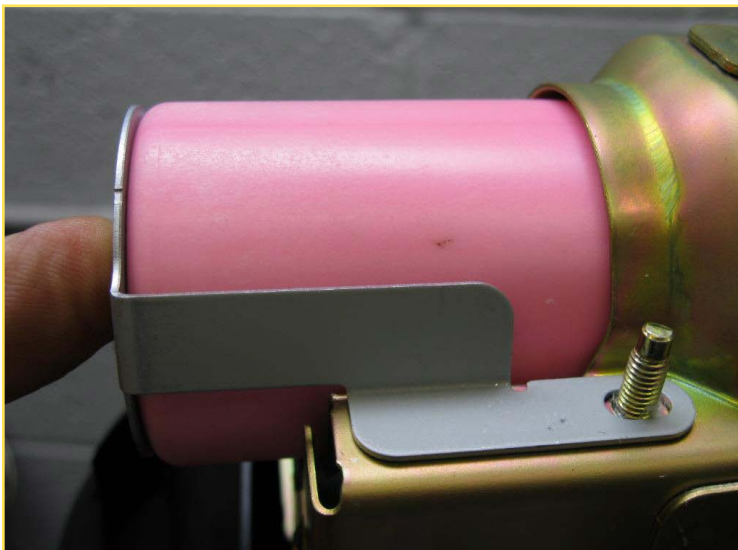

Always hold the stopper plate tight against the inflator as shown when installing and tightening the **NEW** self-locking nuts. **NEVER** reuse the original nuts.

Remove the 2 nuts still installed on the mounting bracket and replace them with 2 **NEW** self-locking nuts. Once all 4 **NEW** nuts are in place, torque to 31 - 38 inch pounds in the new sequence shown below. Use a marker to mark the nuts after torquing indicating they have been fully tightened.



STEP 12- Peel off the white dust cover and **CAREFULLY** align the tang of the new harness connector with the receiving slot in the inflator connector. This assures proper routing of the harness in relation to the airbag assembly mounting brackets.

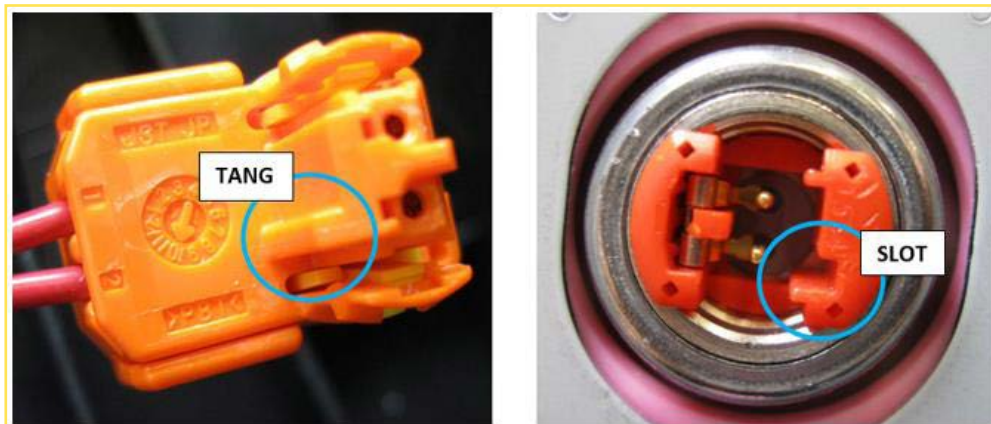

Continued...

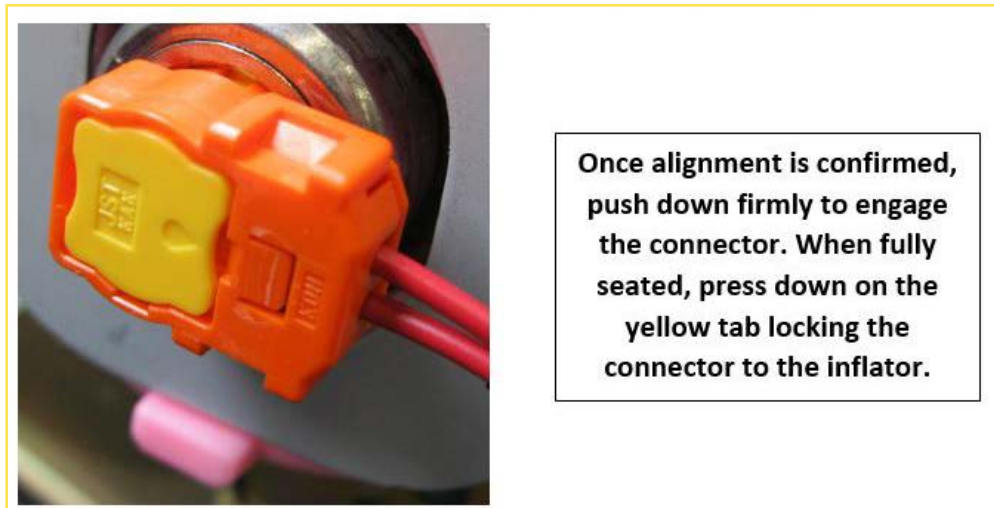

Step 13- Reinstall the wiring harness retaining clip into its position on the mounting bracket.
IMPORTANT: Confirm the harness is not twisted at the inflator connector as shown below.

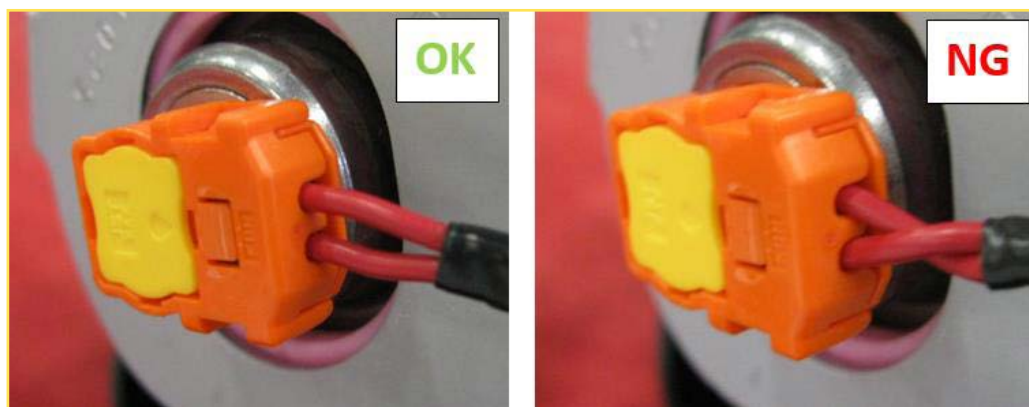

STEP 14- Peel the adhesive backing and install the new Sponge Tape onto the yellow harness tube first then adhere it to the airbag mounting bracket as shown in the illustrations below.

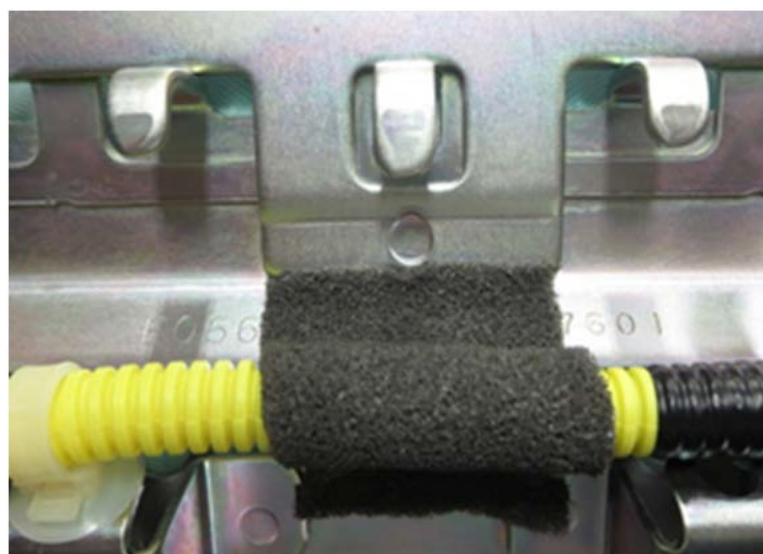

Placement of Sponge Tape

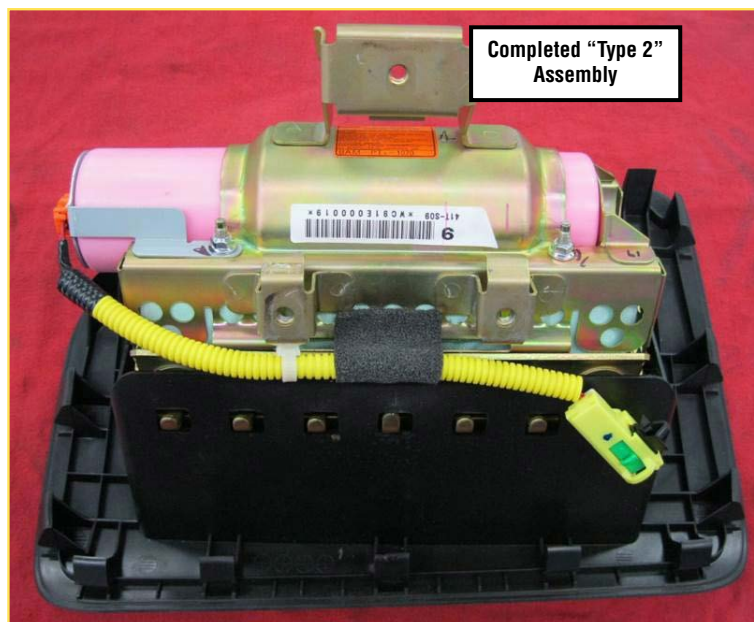
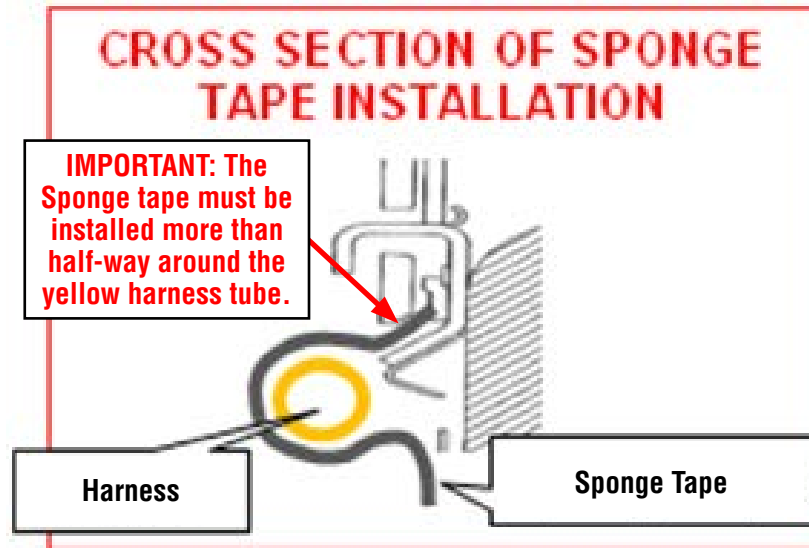

STEP 15- Reinstall the airbag assembly into the vehicle in reverse order of disassembly.
NOTE: If the accessory security module is installed to one of the airbag module mounting bolts, torque that specific bolt to 7.5 +/-1ft. lb. rather than the normal 5.4 ft. lb. specified in the Service Manual. Before installing the glove box assembly, reconnect the negative battery cable. Turn the ignition key "ON" and confirm the AIRBAG warning light comes on then cycles off properly. Once proper warning light operation is confirmed, reinstall the glove box assembly while making sure the cord loop for the opening dampener (if equipped) stays connected to complete the procedure.

STEP 16- Place the removed air bag inflator in the "cradle" of the Kit Box insert, with a completed SOA warranty parts tag (MSA5W402A) attached to it. The tag must contain the following information: **Claim Number, Repair Date, 17-digit VIN, and vehicle mileage.** Refer to the "PARTS RETURN PROCEDURES" section of this bulletin (page 4) for further return shipping instructions and information.

IMPORTANT: UNDER NO CIRCUMSTANCES SHOULD ANY AIR BAG INFLATORS BE RETURNED TO SUBARU OF AMERICA, INC.

Continued...

RECALL IDENTIFICATION LABEL

Type or print the necessary information on a Service Program identification label. The completed label should be attached to the vehicle's upper radiator support.

Additional labels are available through normal parts ordering channels. The part number is MSA6P1302. Ordering qty 1 = 1 sheet of 20 labels.

PART NUMBER	APPLICABILITY	DESCRIPTION	ORDER QUANTITY
MSA6P1302	All models	Campaign Completion Labels (contains one sheet of 20 labels)	1

SUBARU
Campaign Code
WQR-53
COMPLETED
DIST./DEALER NO.
SERIAL NO.
DO NOT REMOVE

CLAIM REIMBURSEMENT AND ENTRY PROCEDURES

Credit to perform this recall will be based on the submission of properly completed repair order information. Retailers may submit claims through 'Vehicle Claim Entry' on Subarunet.com.

Listed below is claim entry information:

CLAIM TYPE	CAMPAIGN CODE	LABOR	DESCRIPTION	LABOR TIME
RC	WQR-53	A182-031	2003-2004 Legacy, Outback, Baja 2004-2005 Impreza, WRX, STI Front Passenger Air Bag Inflator Replacement	0.8
			2005-2008 Legacy, Outback Front Passenger Air Bag Inflator Replacement	1.8

PART NUMBER	APPLICABILITY	DESCRIPTION	ORDER QUANTITY
98279AE00A	2003-2004 Legacy, 2003-2004 Outback and 2003-2004 Baja	Air Bag Inflator Module Kit	1
98279FE000	2004-2005 Impreza, WRX, and STI	Air Bag Inflator Module Kit (Inflator Type 1)	1
98279FE070		Air Bag Inflator Module Kit (Inflator Type 2)	1
98279AG00A	2005-2008 Legacy and Outback	Air Bag Inflator Module Kit	1

Miscellaneous Detail	Enter the serial number of the NEW air bag inflator installed in the "Misc. Details" field.
-----------------------------	---

Continued...

OWNER NOTIFICATION LETTER

IMPORTANT SAFETY RECALL

This notice applies to the VIN identified in the address section printed below.



SUBARU

Subaru of America, Inc

Subaru Plaza

PO Box 6000

Cherry Hill, NJ 08034-6000

800-782-2783

www.subaru.com

Subaru Recall Campaign WQR-53

NHTSA Recall No. 15V-323

June 2015

Dear Subaru Owner:

This notice is sent to you in accordance with the National Traffic and Motor Vehicle Safety Act.

SUBARU OF AMERICA, INC. has decided that a defect, which relates to motor vehicle safety, exists in certain 2004 and 2005 model year Impreza, WRX, and STI vehicles.

You received this notice because our records indicate that you currently own one of these vehicles.

DESCRIPTION OF THE SAFETY DEFECT AND SAFETY HAZARD

The affected vehicles are equipped with a passenger side frontal air bag that may be susceptible to moisture intrusion which, over time, could cause the inflator to rupture upon its deployment.

In the event of a crash necessitating deployment of the passenger's frontal air bag, the inflator could rupture with metal fragments striking the vehicle occupants potentially resulting in serious injury or death.

REMEDY

WHAT YOU SHOULD DO

You should immediately contact your Subaru retailer (dealer) for an appointment to have the front passenger air bag inflator replaced with a new one.

Until this repair is performed, do not allow passengers to ride in the front passenger seat.

Subaru will replace the inflator for your front passenger air bag at no cost to you.

HOW LONG WILL THE REPAIR TAKE?

The time to replace the front passenger air bag inflator is approximately 40 minutes. However, it may be necessary to leave your vehicle for a longer period of time on the day of your scheduled appointment to allow your Subaru retailer flexibility in scheduling. Please present this letter to your Subaru retailer at the time this repair procedure is performed.

CHANGED YOUR ADDRESS OR SOLD YOUR SUBARU?

If you have moved or sold your vehicle, please complete the enclosed prepaid postcard and mail it to us. Or if you prefer to update this information online, please go to www.subaru.com, select 'Customer Support,' then select 'Address Update' or 'Ownership Update' from the drop down menu.

Continued...

IF YOU NEED FURTHER ASSISTANCE:

To locate the nearest Subaru retailer you can access our website at www.subaru.com and select 'Find a Retailer.'

For additional information and the most Frequently Asked Questions, please go to:

- <http://www.wqr53.service-campaign.com>

If you need additional assistance, please contact us directly:

- By e-mail: Go to www.subaru.com and select "Contact Us"
- By telephone: 1-800-SUBARU3 (1-800-782-2783)
Monday through Thursday between 7:30 a.m. and 8:00 p.m. ET
Friday between 10:30 a.m. and 5:00 p.m. ET
Saturday between 9:00 a.m. and 3:30 p.m. ET
- By U.S. Postal mail: Write us at Subaru of America, Inc., Attn: Customer-Retailer Services Department,
P.O. Box 6000, Cherry Hill, NJ 08034-6000

Please contact us immediately if the Subaru retailer fails or is unable to make the necessary repairs free of charge.

You may also contact the Administrator, National Highway Traffic Safety Administration, 1200 New Jersey Ave. SE, West Building, Washington, DC 20590 or call the toll free Auto Safety Hotline at 1-888-327-4236 (TTY: 1-800-424-9153) or go to <http://www.safercar.gov> if you believe the Subaru retailer has failed or is unable to remedy your vehicle without charge within a reasonable amount of time.

Your continued satisfaction with your Subaru is important to us. Please understand that we have taken this action in the interest of your safety and your vehicle's proper operation. We sincerely apologize for any inconvenience this matter may cause and urge you to schedule an appointment as soon as possible to have this repair performed.

Sincerely,
Subaru of America, Inc.

Notice to Lessors: Under Federal law the lessor of a vehicle who receives this letter must provide a copy of it to the vehicle lessee(s) within 10 business days from receipt. The lessor must also keep a record of the lessee(s) to whom this letter is sent, the date sent, and the applicable vehicle identification number (VIN). (For the purposes of this section, a lessor means a person or entity that in the last twelve months prior to the date of this notification has been the owner, as referenced on the vehicle's title, of any five or more leased vehicles. A leased vehicle is a vehicle leased to another person for a term of at least four months.)

A subsidiary of Fuji Heavy Industries Ltd.

Continued...

OWNER NOTIFICATION LETTER

IMPORTANT SAFETY RECALL

This notice applies to the VIN identified in the address section printed below.



SUBARU

Subaru of America, Inc

Subaru Plaza

PO Box 6000

Cherry Hill, NJ 08034-6000

800-782-2783

www.subaru.com

Subaru Recall Campaign WQR-53

NHTSA Recall No. 15V-323

July 2015

Dear Subaru Owner:

This notice is sent to you in accordance with the National Traffic and Motor Vehicle Safety Act.

SUBARU OF AMERICA, INC. has decided that a defect, which relates to motor vehicle safety, exists in certain 2004 and 2005 model year Impreza, WRX, and STI vehicles.

You received this notice because our records indicate that you currently own one of these vehicles.

DESCRIPTION OF THE SAFETY DEFECT AND SAFETY HAZARD

The affected vehicles are equipped with a passenger side frontal air bag that may be susceptible to moisture intrusion which, over time, could cause the inflator to rupture upon its deployment.

In the event of a crash necessitating deployment of the passenger's frontal air bag, the inflator could rupture with metal fragments striking the vehicle occupants potentially resulting in serious injury or death.

REPAIR

Subaru will replace the inflator for your front passenger air bag at no cost to you.

WHAT YOU SHOULD DO

We are currently experiencing a parts shortage for affected Impreza, WRX, and STI vehicles. As the parts supply improves, you will be notified with another letter advising you to schedule an appointment with your Subaru retailer (dealer) to have the front passenger airbag inflator replaced with a new one if you have not already had the repair performed.

Until this repair is performed, do not allow passengers to ride in the front passenger seat.

HOW LONG WILL THE REPAIR TAKE?

The time to replace the front passenger air bag inflator is approximately 40 minutes. However, it may be necessary to leave your vehicle for a longer period of time on the day of your scheduled appointment to allow your Subaru retailer flexibility in scheduling. Please present this letter to your Subaru retailer at the time this repair procedure is performed.

CHANGED YOUR ADDRESS OR SOLD YOUR SUBARU?

If you have moved or sold your vehicle, please complete the enclosed prepaid postcard and mail it to us. Or if you prefer to update this information online, please go to www.subaru.com, select 'Customer Support,' then select 'Address Update' or 'Ownership Update' from the drop down menu.

Continued...

IF YOU NEED FURTHER ASSISTANCE:

To locate the nearest Subaru retailer you can access our website at www.subaru.com and select 'Find a Retailer.'

For additional information and the most Frequently Asked Questions, please go to:

- <http://www.wqr53.service-campaign.com>

If you need additional assistance, please contact us directly:

- By e-mail: Go to www.subaru.com and select "Contact Us"
- By telephone: 1-800-SUBARU3 (1-800-782-2783)
Monday through Thursday between 7:30 a.m. and 8:00 p.m. ET
Friday between 10:30 a.m. and 5:00 p.m. ET
Saturday between 9:00 a.m. and 3:30 p.m. ET
- By U.S. Postal mail: Write us at Subaru of America, Inc., Attn: Customer-Retailer Services Department,
P.O. Box 6000, Cherry Hill, NJ 08034-6000

Please contact us immediately if the Subaru retailer fails or is unable to make the necessary repairs free of charge.

You may also contact the Administrator, National Highway Traffic Safety Administration, 1200 New Jersey Ave. SE, West Building, Washington, DC 20590 or call the toll free Auto Safety Hotline at 1-888-327-4236 (TTY: 1-800-424-9153) or go to <http://www.safercar.gov> if you believe the Subaru retailer has failed or is unable to remedy your vehicle without charge within a reasonable amount of time.

Your continued satisfaction with your Subaru is important to us. Please understand that we have taken this action in the interest of your safety and your vehicle's proper operation. We sincerely apologize for any inconvenience this matter may cause and urge you to schedule an appointment as soon as possible to have this repair performed.

Sincerely,
Subaru of America, Inc.

Notice to Lessors: Under Federal law the lessor of a vehicle who receives this letter must provide a copy of it to the vehicle lessee(s) within 10 business days from receipt. The lessor must also keep a record of the lessee(s) to whom this letter is sent, the date sent, and the applicable vehicle identification number (VIN). (For the purposes of this section, a lessor means a person or entity that in the last twelve months prior to the date of this notification has been the owner, as referenced on the vehicle's title, of any five or more leased vehicles. A leased vehicle is a vehicle leased to another person for a term of at least four months.)

A subsidiary of Fuji Heavy Industries Ltd.

Continued...

OWNER NOTIFICATION LETTER

IMPORTANT SAFETY RECALL

This notice applies to the VIN identified in the address section printed below.



SUBARU

Subaru of America, Inc
Subaru Plaza
PO Box 6000
Cherry Hill, NJ 08034-6000
800-782-2783
www.subaru.com

**Subaru Recall Campaign WQR-53
Legacy, Outback, and Baja
NHTSA Recall No. 15V-323
September 2015**

Dear Subaru Owner:

This notice is sent to you in accordance with the National Traffic and Motor Vehicle Safety Act.

SUBARU OF AMERICA, INC. has decided that a defect, which relates to motor vehicle safety, exists in certain 2003-2004 model year Legacy, Outback, and Baja vehicles.

DESCRIPTION OF THE SAFETY DEFECT AND SAFETY HAZARD

Subaru is consolidating two previous national recalls into one. The vehicles included in this consolidated national recall may contain a front passenger-side air bag inflator which could rupture with metal fragments striking the vehicle occupants potentially resulting in serious injury or death.

You received this notice because our records indicate that you currently own one of these vehicles and the recall has not yet been completed. If you have already had this repair performed, please disregard this notice.

REPAIR

Subaru will replace the inflator for your front passenger air bag at no cost to you.

WHAT YOU SHOULD DO

You should immediately contact your Subaru retailer (dealer) for an appointment to have the front passenger air bag inflator replaced with a new one.

You should immediately contact your Subaru retailer (dealer) for an appointment to have the front passenger air bag inflator replaced with a new one.

HOW LONG WILL THE REPAIR TAKE?

The time to replace the front passenger air bag inflator is approximately 40 minutes. However, it may be necessary to leave your vehicle for a longer period of time on the day of your scheduled appointment to allow your Subaru retailer flexibility in scheduling. Please present this letter to your Subaru retailer at the time this repair procedure is performed.

CHANGED YOUR ADDRESS OR SOLD YOUR SUBARU?

If you have moved or sold your vehicle, please complete the enclosed prepaid postcard and mail it to us.

Continued...

IF YOU NEED FURTHER ASSISTANCE:

To locate the nearest Subaru retailer you can access our website at www.subaru.com and select “Find a Retailer”.

For additional information and the most Frequently Asked Questions, please go to:

- <http://www.wqr53.service-campaign.com>

If you need additional assistance, please contact us directly:

- By e-mail: Go to www.subaru.com and select “Contact Us”
- By telephone: 1-800-SUBARU3 (1-800-782-2783)
Monday through Thursday between 7:30 a.m. and 8:00 p.m. ET
Friday between 10:30 a.m. and 5:00 p.m. ET
Saturday between 9:00 a.m. and 3:30 p.m. ET
- By U.S. Postal mail: Write us at Subaru of America, Inc., Attn: Customer-Retailer Services Department,
P.O. Box 6000, Cherry Hill, NJ 08034-6000

Please contact us immediately if the Subaru retailer fails or is unable to make the necessary repairs free of charge.

You may also contact the Administrator, National Highway Traffic Safety Administration, 1200 New Jersey Ave. SE, West Building, Washington, DC 20590 or call the toll free Auto Safety Hotline at 1-888-327-4236 (TTY: 1-800-424-9153) or go to <http://www.safercar.gov> if you believe the Subaru retailer has failed or is unable to remedy your vehicle without charge within a reasonable amount of time.

Your continued satisfaction with your Subaru is important to us. Please understand that we have taken this action in the interest of your safety and your vehicle’s proper operation. We sincerely apologize for any inconvenience this matter may cause and urge you to schedule an appointment as soon as possible to have this repair performed.

Sincerely,
Subaru of America, Inc.

Notice to Lessors: Under Federal law the lessor of a vehicle who receives this letter must provide a copy of it to the vehicle lessee(s) within 10 business days from receipt. The lessor must also keep a record of the lessee(s) to whom this letter is sent, the date sent, and the applicable vehicle identification number (VIN). (For the purposes of this section, a lessor means a person or entity that in the last twelve months prior to the date of this notification has been the owner, as referenced on the vehicle’s title, of any five or more leased vehicles. A leased vehicle is a vehicle leased to another person for a term of at least four months.)

A subsidiary of Fuji Heavy Industries Ltd.

Continued...

OWNER NOTIFICATION LETTER

IMPORTANT SAFETY RECALL

This notice applies to the VIN identified in the address section printed below.



SUBARU

Subaru of America, Inc
Subaru Plaza
PO Box 6000
Cherry Hill, NJ 08034-6000
800-782-2783
www.subaru.com

**Subaru Recall Campaign WQR-53
Impreza, WRX, and STI
NHTSA Recall No. 15V-323
September 2015**

Dear Subaru Owner:

This notice is sent to you in accordance with the National Traffic and Motor Vehicle Safety Act.

SUBARU OF AMERICA, INC. has decided that a defect, which relates to motor vehicle safety, exists in certain 2004 model year Impreza, WRX, and STI vehicles.

DESCRIPTION OF THE SAFETY DEFECT AND SAFETY HAZARD

Subaru is consolidating two previous national recalls into one. The vehicles included in this consolidated national recall may contain a front passenger-side air bag inflator which could rupture with metal fragments striking the vehicle occupants potentially resulting in serious injury or death.

You received this notice because our records indicate that you currently own one of these vehicles and the recall has not yet been completed. If you have already had this repair performed, please disregard this notice.

REPAIR

Subaru will replace the inflator for your front passenger air bag at no cost to you.

WHAT YOU SHOULD DO

We are currently experiencing a parts shortage for affected Impreza, WRX, and STI vehicles. As the parts supply improves, you will be notified with another letter advising you to schedule an appointment with your Subaru retailer (dealer) to have the front passenger airbag inflator replaced with a new one if you have not already had the repair performed.

Until this repair is performed, do not allow passengers to ride in the front passenger seat.

HOW LONG WILL THE REPAIR TAKE?

The time to replace the front passenger air bag inflator is approximately 40 minutes. However, it may be necessary to leave your vehicle for a longer period of time on the day of your scheduled appointment to allow your Subaru retailer flexibility in scheduling.

CHANGED YOUR ADDRESS OR SOLD YOUR SUBARU?

If you have moved or sold your vehicle, please complete the enclosed prepaid postcard and mail it to us.

Continued...

IF YOU NEED FURTHER ASSISTANCE:

To locate the nearest Subaru retailer you can access our website at www.subaru.com and select ‘Find a Retailer.’

For additional information and the most Frequently Asked Questions, please go to:

- <http://www.wqr53.service-campaign.com>

If you need additional assistance, please contact us directly:

- By e-mail: Go to www.subaru.com and select “Contact Us”
- By telephone: 1-800-SUBARU3 (1-800-782-2783)
Monday through Thursday between 7:30 a.m. and 8:00 p.m. ET
Friday between 10:30 a.m. and 5:00 p.m. ET
Saturday between 9:00 a.m. and 3:30 p.m. ET
- By U.S. Postal mail: Write us at Subaru of America, Inc., Attn: Customer-Retailer Services Department,
P.O. Box 6000, Cherry Hill, NJ 08034-6000

Please contact us immediately if the Subaru retailer fails or is unable to make the necessary repairs free of charge.

You may also contact the Administrator, National Highway Traffic Safety Administration, 1200 New Jersey Ave. SE, West Building, Washington, DC 20590 or call the toll free Auto Safety Hotline at 1-888-327-4236 (TTY: 1-800-424-9153) or go to <http://www.safercar.gov> if you believe the Subaru retailer has failed or is unable to remedy your vehicle without charge within a reasonable amount of time.

Your continued satisfaction with your Subaru is important to us. Please understand that we have taken this action in the interest of your safety and your vehicle’s proper operation. We sincerely apologize for any inconvenience this matter may cause.

Sincerely,
Subaru of America, Inc.

Notice to Lessors: Under Federal law the lessor of a vehicle who receives this letter must provide a copy of it to the vehicle lessee(s) within 10 business days from receipt. The lessor must also keep a record of the lessee(s) to whom this letter is sent, the date sent, and the applicable vehicle identification number (VIN). (For the purposes of this section, a lessor means a person or entity that in the last twelve months prior to the date of this notification has been the owner, as referenced on the vehicle’s title, of any five or more leased vehicles. A leased vehicle is a vehicle leased to another person for a term of at least four months.)

A subsidiary of Fuji Heavy Industries Ltd.

Continued...

OWNER NOTIFICATION LETTER

IMPORTANT SAFETY RECALL

This notice applies to the VIN identified in the address section printed below.



SUBARU

Subaru of America, Inc
Subaru Plaza
PO Box 6000
Cherry Hill, NJ 08034-6000
800-782-2783
www.subaru.com

**Subaru Recall Campaign WQR53
NHTSA Recall No. 15V-323
2005-2008 Legacy and Outback
January 2016**

Dear Subaru Owner:

This notice is sent to you in accordance with the National Traffic and Motor Vehicle Safety Act.

Subaru of America, Inc. has decided that a defect which relates to motor vehicle safety exists in certain 2005-2008 model year Subaru Legacy and Outback vehicles.

You received this notice because our records indicate that you currently own one of these vehicles.

REASON FOR THIS NOTICE

Subaru is expanding a previously issued recall to include additional vehicles. Your vehicle is among those added.

SAFETY HAZARD

In the event of a crash necessitating deployment of the front passenger air bag, the inflator could rupture with metal fragments striking vehicle occupants and potentially causing serious injury or death.

The registration history of your vehicle indicates that your vehicle has been registered in an area of high absolute humidity. Therefore, your vehicle is included in the highest priority group (Priority Group 1) as defined in the NHTSA (National Highway Traffic Safety Administration) Coordinated Remedy Order. For more information about this Order, please refer to <http://www.safercar.gov/rs/takata/index.html>.

REMEDY

Subaru will replace the inflator for your front passenger air bag at no cost to you.

WHAT YOU SHOULD DO

You should immediately contact your Subaru retailer (dealer) for an appointment to have the front passenger air bag inflator replaced with a new one.

It is important that you are aware that your vehicle is affected by this safety recall and that you should take the following precaution:

Until this repair is performed, do not allow passengers to ride in the front passenger seat.

HOW LONG WILL THE REPAIR TAKE?

The time to replace the front passenger air bag inflator is approximately one hour and 45 minutes. It may be necessary to leave your vehicle for a longer period of time on the day of your scheduled appointment to allow your Subaru retailer flexibility in scheduling. Please present this letter to your Subaru retailer at the time this repair procedure is performed.

Continued...

CHANGED YOUR ADDRESS OR SOLD YOUR SUBARU?

If you have moved or sold your vehicle, please complete the enclosed prepaid postcard and mail it to us. Or if you prefer to update this information online, please go to www.subaru.com, select 'Customer Support,' then select 'Address Update' or 'Ownership Update' from the drop down menu.

IF YOU NEED FURTHER ASSISTANCE:

To locate the nearest Subaru retailer you can access our website at www.subaru.com and select 'Find a Retailer.'

For additional information and the most Frequently Asked Questions, please go to:

- <http://www.wqr53.service-campaign.com>

If you need additional assistance, please contact us directly:

- By e-mail: Go to www.subaru.com and select "Contact Us"
- By telephone: 1-800-SUBARU3 (1-800-782-2783)
Monday through Thursday between 7:30 a.m. and 8:00 p.m. ET
Friday between 10:30 a.m. and 5:00 p.m. ET
Saturday between 9:00 a.m. and 3:30 p.m. ET
- By U.S. Postal mail: Write us at Subaru of America, Inc., Attn: Customer-Retailer Services Department, P.O. Box 6000, Cherry Hill, NJ 08034-6000

Please contact us immediately if the Subaru retailer fails or is unable to make the necessary repairs free of charge.

You may also contact the Administrator, National Highway Traffic Safety Administration, 1200 New Jersey Ave. SE, West Building, Washington, DC 20590 or call the toll free Auto Safety Hotline at 1-888-327-4236 (TTY: 1-800-424-9153) or go to <http://www.safercar.gov> if you believe the Subaru retailer has failed or is unable to remedy your vehicle without charge within a reasonable amount of time.

Your continued satisfaction with your Subaru is important to us. Please understand that we have taken this action in the interest of your safety and your vehicle's proper operation. We sincerely apologize for any inconvenience this matter may cause and urge you to schedule an appointment as soon as possible to have this repair performed.

Sincerely,
Subaru of America, Inc.

Notice to Lessors: Under Federal law the lessor of a vehicle who receives this letter must provide a copy of it to the vehicle lessee(s) within 10 business days from receipt. The lessor must also keep a record of the lessee(s) to whom this letter is sent, the date sent, and the applicable vehicle identification number (VIN). (For the purposes of this section, a lessor means a person or entity that in the last twelve months prior to the date of this notification has been the owner, as referenced on the vehicle's title, of any five or more leased vehicles. A leased vehicle is a vehicle leased to another person for a term of at least four months.)

A subsidiary of Fuji Heavy Industries Ltd.

Continued...

OWNER NOTIFICATION LETTER

IMPORTANT SAFETY RECALL

This notice applies to the VIN identified in the address section printed below.



SUBARU

Subaru of America, Inc
Subaru Plaza
PO Box 6000
Cherry Hill, NJ 08034-6000
800-782-2783
www.subaru.com

**Subaru Recall Campaign WQR53
NHTSA Recall No. 15V-323
2005-2008 Legacy and Outback
February 2016**

Dear Subaru Owner:

This notice is sent to you in accordance with the National Traffic and Motor Vehicle Safety Act.

Subaru of America, Inc. has decided that a defect which relates to motor vehicle safety exists in certain 2005-2008 model year Subaru Legacy and Outback vehicles.

You received this notice because our records indicate that you currently own one of these vehicles.

REASON FOR THIS NOTICE

Subaru is expanding a previously issued recall to include additional vehicles. Your vehicle is among those added.

SAFETY HAZARD

In the event of a crash necessitating deployment of the front passenger air bag, the inflator could rupture with metal fragments striking vehicle occupants and potentially causing serious injury or death.

REMEDY

Subaru will replace the inflator for your front passenger air bag at no cost to you.

WHAT YOU SHOULD DO

We are currently experiencing a parts shortage. However it is important that you are aware that your vehicle is affected by this safety recall and that you should take the following precaution:

Until this repair is performed, do not allow passengers to ride in the front passenger seat.

As the parts supply improves, you will be notified with another letter advising you to schedule an appointment with your Subaru retailer (dealer) to have the front passenger airbag inflator replaced with a new one if you have not already had the repair performed.

HOW LONG WILL THE REPAIR TAKE?

The time to replace the front passenger air bag inflator is approximately one hour and 45 minutes. It may be necessary to leave your vehicle for a longer period of time on the day of your scheduled appointment to allow your Subaru retailer flexibility in scheduling. Please present this letter to your Subaru retailer at the time this repair procedure is performed.

Continued...

CHANGED YOUR ADDRESS OR SOLD YOUR SUBARU?

If you have moved or sold your vehicle, please complete the enclosed prepaid postcard and mail it to us.

IF YOU NEED FURTHER ASSISTANCE:

To locate the nearest Subaru retailer you can access our website at www.subaru.com and select "Find a Retailer".

For additional information and the most Frequently Asked Questions, please go to:

- <http://www.wqr53.service-campaign.com>

If you need additional assistance, please contact us directly:

- By e-mail: Go to www.subaru.com and select "Contact Us"
- By telephone: 1-800-SUBARU3 (1-800-782-2783)
Monday through Thursday between 7:30 a.m. and 8:00 p.m. ET
Friday between 10:30 a.m. and 5:00 p.m. ET
Saturday between 9:00 a.m. and 3:30 p.m. ET
- By U.S. Postal mail: Write us at Subaru of America, Inc., Attn: Customer-Retailer Services Department, P.O. Box 6000, Cherry Hill, NJ 08034-6000

Please contact us immediately if the Subaru retailer fails or is unable to make the necessary repairs free of charge.

You may also contact the Administrator, National Highway Traffic Safety Administration, 1200 New Jersey Ave. SE, West Building, Washington, DC 20590 or call the toll free Auto Safety Hotline at 1-888-327-4236 (TTY: 1-800-424-9153) or go to <http://www.safercar.gov> if you believe the Subaru retailer has failed or is unable to remedy your vehicle without charge within a reasonable amount of time.

Your continued satisfaction with your Subaru is important to us. Please understand that we have taken this action in the interest of your safety and your vehicle's proper operation. We sincerely apologize for any inconvenience this matter may cause and urge you to schedule an appointment as soon as possible to have this repair performed.

Sincerely,
Subaru of America, Inc.

Notice to Lessors: Under Federal law the lessor of a vehicle who receives this letter must provide a copy of it to the vehicle lessee(s) within 10 business days from receipt. The lessor must also keep a record of the lessee(s) to whom this letter is sent, the date sent, and the applicable vehicle identification number (VIN). (For the purposes of this section, a lessor means a person or entity that in the last twelve months prior to the date of this notification has been the owner, as referenced on the vehicle's title, of any five or more leased vehicles. A leased vehicle is a vehicle leased to another person for a term of at least four months.)

A subsidiary of Fuji Heavy Industries Ltd.

Continued...

OWNER NOTIFICATION LETTER

IMPORTANT SAFETY RECALL

This notice applies to the VIN identified
in the address section printed below.



SUBARU

Subaru of America, Inc
Subaru Plaza
PO Box 6000
Cherry Hill, NJ 08034-6000
800-782-2783
www.subaru.com

Subaru Recall Campaign WQR-53
NHTSA Recall No. 15V-323
April 2016 – Second Notification

Dear Subaru Owner:

This notice is sent to you in accordance with the National Traffic and Motor Vehicle Safety Act.

SUBARU OF AMERICA, INC. has decided that a defect, which relates to motor vehicle safety, exists in certain 2004 and 2005 model year Impreza, WRX, and STI vehicles.

You received this notice because our records indicate that you currently own one of these vehicles.

DESCRIPTION OF THE SAFETY DEFECT AND SAFETY HAZARD

The affected vehicles are equipped with a passenger side frontal air bag that may be susceptible to moisture intrusion which, over time, could cause the inflator to rupture upon its deployment.

In the event of a crash necessitating deployment of the passenger's frontal air bag, the inflator could rupture with metal fragments striking the vehicle occupants potentially resulting in serious injury or death.

REPAIR

Subaru will replace the inflator for your front passenger air bag at no cost to you.

WHAT YOU SHOULD DO

In the event of a crash necessitating deployment of the front passenger air bag, the inflator could rupture with metal fragments striking vehicle occupants and potentially causing serious injury or death.

Sufficient parts supply is now available. You should immediately contact your Subaru retailer (dealer) for an appointment to have the front passenger air bag inflator replaced with a new one.

Until this repair is performed, do not allow passengers to ride in the front passenger seat.

HOW LONG WILL THE REPAIR TAKE?

The time to replace the front passenger air bag inflator is approximately 40 minutes. However, it may be necessary to leave your vehicle for a longer period of time on the day of your scheduled appointment to allow your Subaru retailer flexibility in scheduling. Please present this letter to your Subaru retailer at the time this repair procedure is performed.

Continued...

CHANGED YOUR ADDRESS OR SOLD YOUR SUBARU?

If you have moved or sold your vehicle, please complete the enclosed prepaid postcard and mail it to us.

IF YOU NEED FURTHER ASSISTANCE:

To locate the nearest Subaru retailer you can access our website at www.subaru.com and select "Find a Retailer".

For additional information and the most Frequently Asked Questions, please go to:

- <http://www.wqr53.service-campaign.com>

If you need additional assistance, please contact us directly:

- By e-mail: Go to www.subaru.com and select "Contact Us"
- By telephone: 1-800-SUBARU3 (1-800-782-2783)
Monday through Thursday between 7:30 a.m. and 8:00 p.m. ET
Friday between 10:30 a.m. and 5:00 p.m. ET
Saturday between 9:00 a.m. and 3:30 p.m. ET
- By U.S. Postal mail: Write us at Subaru of America, Inc., Attn: Customer-Retailer Services Department, P.O. Box 6000, Cherry Hill, NJ 08034-6000

Please contact us immediately if the Subaru retailer fails or is unable to make the necessary repairs free of charge.

You may also contact the Administrator, National Highway Traffic Safety Administration, 1200 New Jersey Ave. SE, West Building, Washington, DC 20590 or call the toll free Auto Safety Hotline at 1-888-327-4236 (TTY: 1-800-424-9153) or go to <http://www.safercar.gov> if you believe the Subaru retailer has failed or is unable to remedy your vehicle without charge within a reasonable amount of time.

Your continued satisfaction with your Subaru is important to us. Please understand that we have taken this action in the interest of your safety and your vehicle's proper operation. We sincerely apologize for any inconvenience this matter may cause and urge you to schedule an appointment as soon as possible to have this repair performed.

Sincerely,
Subaru of America, Inc.

Notice to Lessors: Under Federal law the lessor of a vehicle who receives this letter must provide a copy of it to the vehicle lessee(s) within 10 business days from receipt. The lessor must also keep a record of the lessee(s) to whom this letter is sent, the date sent, and the applicable vehicle identification number (VIN). (For the purposes of this section, a lessor means a person or entity that in the last twelve months prior to the date of this notification has been the owner, as referenced on the vehicle's title, of any five or more leased vehicles. A leased vehicle is a vehicle leased to another person for a term of at least four months.)

A subsidiary of Fuji Heavy Industries Ltd.

Continued...

SHIPPING DOCUMENTATION AND INSTRUCTIONS (Appendix A)

NOTE INFLATOR RETURNS

These Return Instructions are for the Continental US dealerships (48 States).

NOTE: Locations outside of the Continental United States (Hawaii, Alaska, Puerto Rico, Virgin Islands INCLUDING Mexico and Canada CANNOT follow below shipping instructions. Instead, dealerships in these locations MUST contact the following Takata/XPO USA representative directly for shipping instructions: Miguel Prigadaa – Tel #: 210-250-5078 or Email: MLGTakataRestrains_International@menlowworldwide.com

1. Shipping Documents

a) Box Label

- Supplied with each Kit
- To be affixed to each box



b) Over-pack Label

- To be supplied by XPO.
- To be affixed to the outside of each pallet

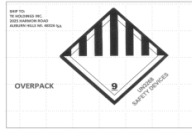

c) Bill of Lading

- To be supplied by XPO.
- Print 2 copies: 1 for Dealer Records, 1 for LTL Driver



d) ERG Document

- To be supplied by XPO.
- To be provide by the Dealer to the LTL Driver for each shipment



4b. Shipping Instructions – Label each Box

a) If you continue receiving Inflator Kits with the original FedEx Documentation:

1. Peel off the backing of the FedEx Ground PRP Shipping label and affix to top of box to left of the Class 9 label.
 - Use the scribe line on the box as a guide
 - The FedEx Ground PRP Shipping label must not touch any portion of the printing to the right of the scribe line.
2. Discard the remaining Documentation
3. Do Not contact FedEx



2. Packing Instructions

a) Confirm box is in acceptable condition. If a new box is needed, follow the New Box instructions located in Box 8 of this page.

b) Place the un-deployed air bag inflator in the "cradle" of the box insert.



5. Shipping Instructions – Prepare the Pallet

a) Accumulate and palletize Kits

b) Arrange Kits on Pallet as pictured here

- 20 boxes per row/layer (5x4)
- 10 rows/layers per pallet (200 boxes)

c) Shrink-wrap Kits to Pallet

d) Affix Over-pack Label on (1) side of Pallet (Not on Top)



3. Closure Instructions

a) Close the top box flap, per box closure instructions located on front panel of box.

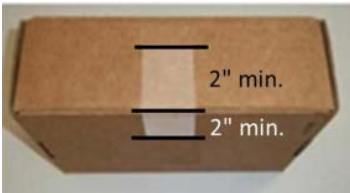

6. Shipping Instructions – Schedule LTL Pickup

a) Upon Accumulating 200 kits (1 Over-pack/Pallet) Minimum

- Call XPO at 1-877-650-3476
- If 200 Kits have not been accumulated in 30 days, please call XPO for direction

c) Have the following Information Available

- Dealer #
- Quantity of Over-packs/Pallets
- Quantity of Passenger Inflator Kits on each Pallet
- Email Address where shipping Documentation can be received

7. Shipping Instructions – Ship

a) Give 1 Copy of BOL and 1 Copy of ERG to Driver

b) Retain 1 Copy of BOL for Dealership records and archive for 2 Years

4a. Shipping Instructions - Label each Box

a) New Labels will begin shipping in each kit starting mid August, 2015

1. Subaru Inflator Kit will contain this two-part label:



2. Peel off 'Ship To' Label.

3. Affix Label to Box. Do not cover up Class 9 Marking.

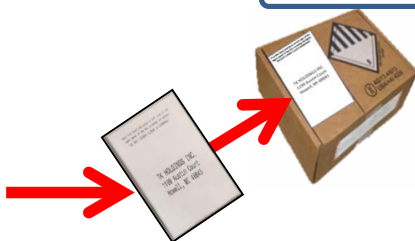

8. Requesting a New Box / Shipping Labels

If a new box or replacement shipping labels are needed, please contact the representative listed below by phone or email to request replacement materials.

Primary Contact: **Armando Gonzalez - Tel #: 210-250-5079**

E-Mail: FieldAction.14305@menlowworldwide.com

To help expedite your request, please be prepared to provide the following information:

a) Serial number on the original box

b) What Type of shipping material needed

- Replacement Box
- Two Part Return Label
- Bill of Lading
- ERG Form

c) Dealer Shipping Information

- Contact name
- Dealer Address
- Phone Number

