



SERVICE BULLETIN

Classification: EL18-017	Reference: NTB18-057	Date: August 7, 2018
-----------------------------	-------------------------	-------------------------

2018 LEAF; MALFUNCTION AND AEB WARNING LIGHTS ON

APPLIED VEHICLES: 2018 LEAF (ZE1)

IF YOU CONFIRM

Malfunction and Automatic Emergency Braking (AEB) warning lights are ON with DTCs:

- **C1B84-00** – (DIST SEN MALFUNCTION)
- **C1A17-49** – (CONTROL UNIT (INTERNAL ELECTRONIC ERROR))



Figure 1

ACTION

1. Install the new Distance Sensor.
2. Add a foam strip to the new Distance Sensor.
3. Perform Radar Alignment.

IMPORTANT: The purpose of ACTION (above) is to give you a quick idea of the work you will be performing. You **MUST** closely follow the entire SERVICE PROCEDURE as it contains information that is essential to successfully completing this repair.

Nissan Bulletins are intended for use by qualified technicians, not 'do-it-yourselfers'. Qualified technicians are properly trained individuals who have the equipment, tools, safety instruction, and know-how to do a job properly and safely. NOTE: If you believe that a described condition may apply to a particular vehicle, DO NOT assume that it does. See your Nissan dealer to determine if this applies to your vehicle.

SERVICE PROCEDURE

1. Remove the old Distance Sensor from the vehicle.

- Refer to the Electronic Service Manual (ESM), Section **REPAIR > CRUISE CONTROL & DRIVER ASSISTANCE > CRUISE CONTROL SYSTEM > REMOVAL AND INSTALLATION > DISTANCE SENSOR (ICC SENSOR)**, for removal information.

2. Install the new Distance Sensor and torque the nuts in the pattern shown in Figure 2.

- The Distance Sensor is listed in the Parts Information.
- **Do not drop or impact the Distance Sensor.**
- Torque nuts to:
10.0 N·m (1.0 kg-m, **7 ft-lb**).
- Make sure Distance Sensor harness is installed without any twists.

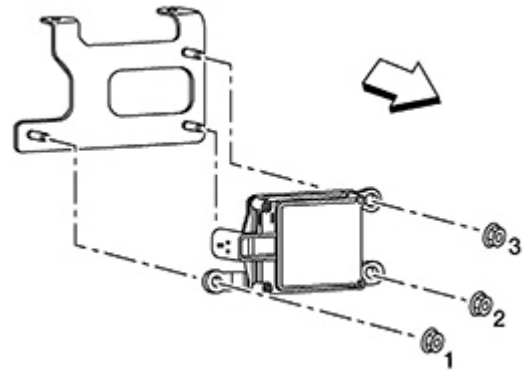

Figure 2

3. Clean the surfaces of the new Distance Sensor, shown in Figure 3.

- Use a soft cloth and isopropyl alcohol.
- Do not allow any isopropyl alcohol into vent (Figure 4).
- **Do not drop or impact the Distance Sensor.**

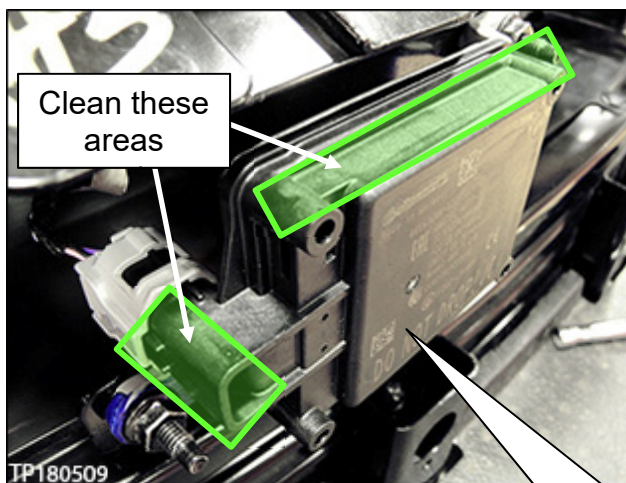

Figure 3



Figure 4

Distance Sensor

4. Attach foam strip to the Distance Sensor as follows:

- Foam strip is listed in the Parts Information.
 - a. Remove the self-adhesive protection strip from the foam strip.
 - b. Align one end of the foam strip to the driver's side and raised edge of the Distance Sensor where shown in Figures 5, 6, 7 and 8, and then start to attach.

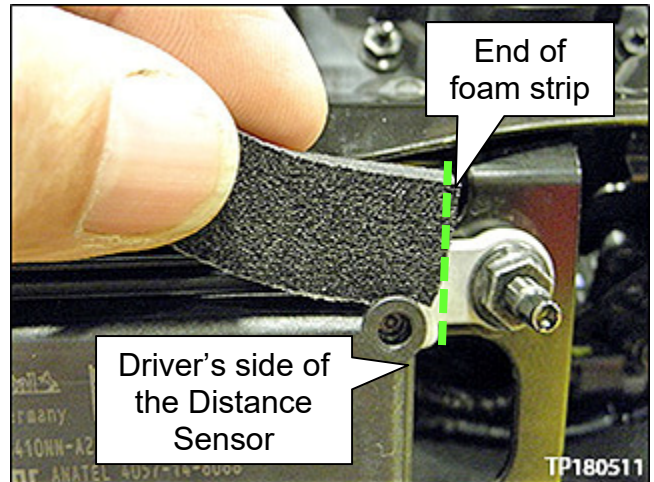

Figure 5

- Figure 6 illustrates alignment of the rear facing edge of foam strip against raised edge of Distance Sensor.

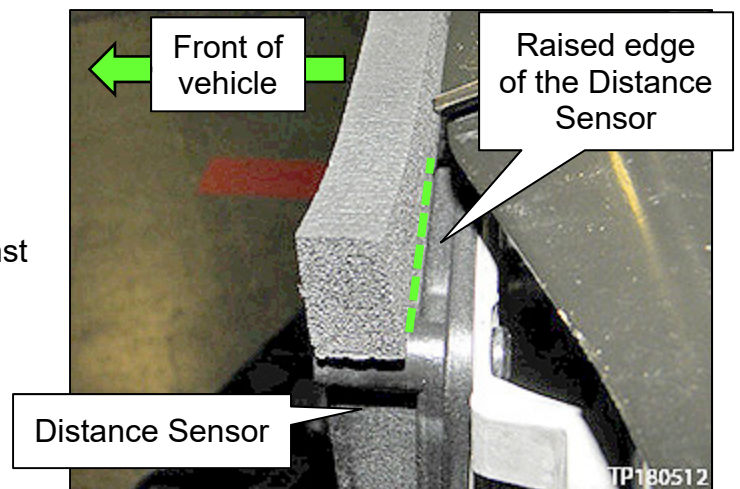

Figure 6

- c. Continue to attach the foam strip along the raised edge of the Distance Sensor.
 - Press firmly to make sure that there is good adhesion between the foam strip and the Distance Sensor.

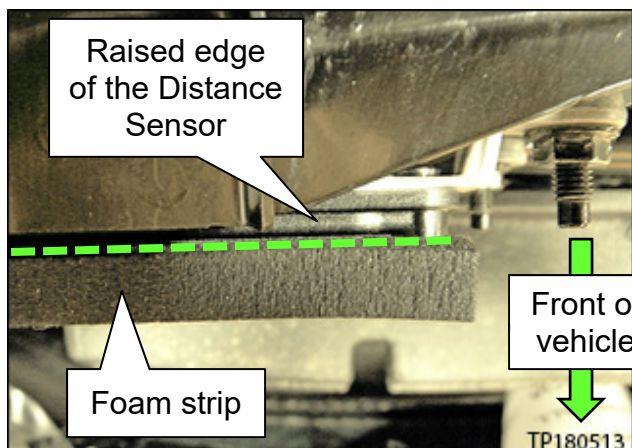

Figure 7

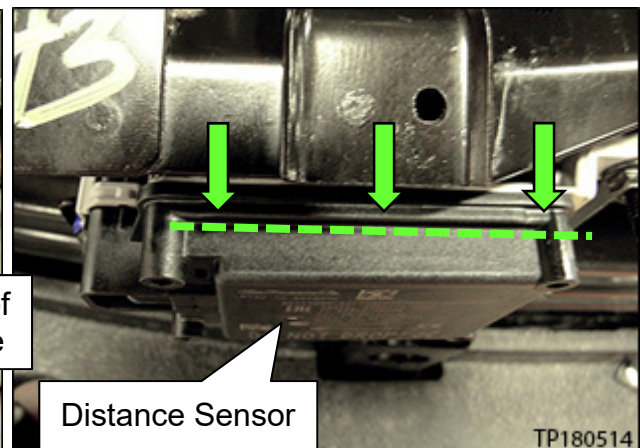

Figure 8

- d. Fold the Foam strip down the left side of the Distance Sensor and attach where shown in Figure 9.

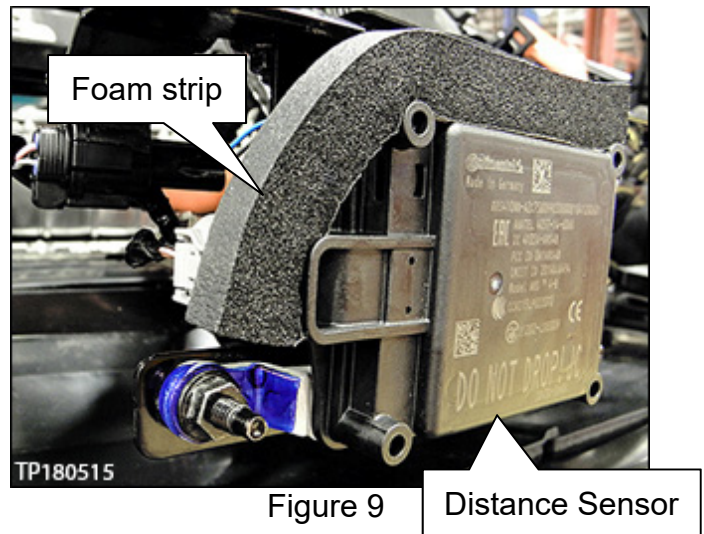

Figure 9

5. Install the remaining components in the reverse order of removal.

6. Perform Radar Alignment.

- Refer to the ESM, Section **DIAGNOSIS > CRUISE CONTROL & DRIVER ASSISTANCE > CRUISE CONTROL SYSTEM > BASIC INSPECTION > ICC > ICC SENSOR ALIGNMENT**, for alignment information.

IMPORTANT: Radar Alignment MUST be performed whenever the Distance Sensor, or components that the Distance Sensor is attached to, are moved, repaired or replaced.

PARTS INFORMATION

DESCRIPTION	PART NUMBER	QUANTITY
Distance Sensor (SENSOR ASSY-DISTANCE)	28438-5SA0C	1
Foam Strip (BRACKET-DISTANCE SENSOR_(FOAM))	28452-5SA0D	1

NOTE:

- New Distance sensor will have mounting tab colored blue, as shown in Figure 10.
- Sensor is shown uninstalled and is for reference only.

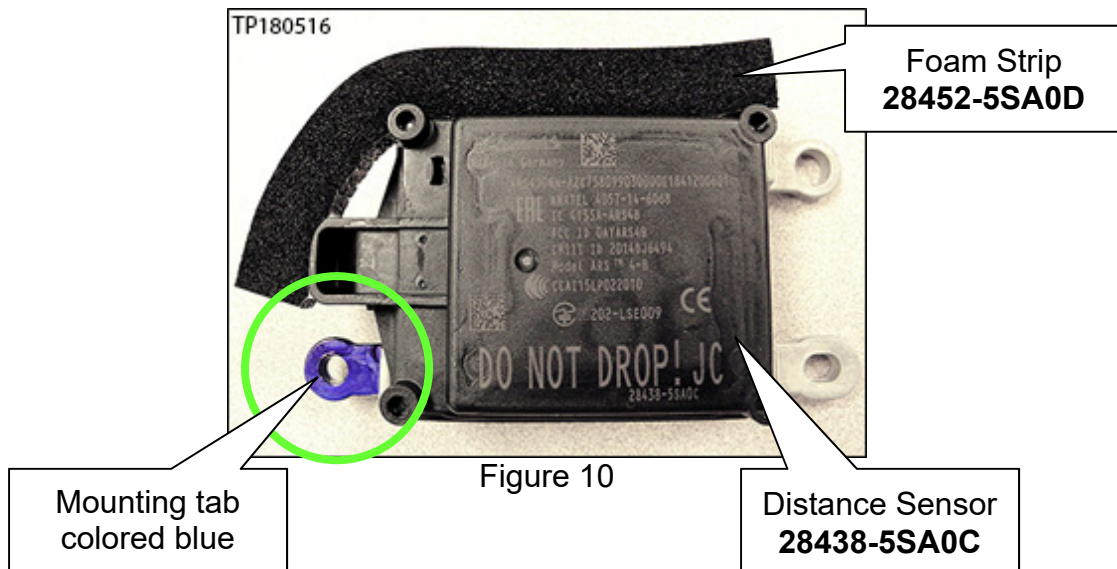

CLAIMS INFORMATION

Submit a Primary Part (PP) type line claim using the following claims coding:

DESCRIPTION	PFP	OP CODE	SYM	DIA	FRT
Install Distance Sensor	(1)	RX6JAA	ZE	32	0.9

(1) Reference the electronic parts catalog and use the Distance Sensor (28438-*****) as the Primary Failed Part (PFP).