

Emissions Recall

Code: 23U7



REVISION

Subject	2.0L TDI Engine (GEN 1) Emissions Modification – Customer Only (Retail Sold) <u>USA ONLY</u>
Release Date	September 12, 2017
Revision Summary	Updated work instructions.
Important Repair Information!	CAMPAIGN 23W1 MUST BE COMPLETED BEFORE BEGINNING THE 23U7 CAMPAIGN! Over the next few weeks there will be updates made to ODIS and the campaign circular. Do not retain any hard copies of campaign circulars – only refer to the electronic copies posted to Elsa and ServiceNet.
Affected Vehicles	U.S.A.: 2010-2013 MY Audi A3 2.0L TDI (Generation 1) <i>Check Campaigns/Actions screen in Elsa on the day of repair to verify that a VIN qualifies for repair under this action. Elsa is the <u>only</u> valid campaign inquiry & verification source.</i> <ul style="list-style-type: none"> ✓ Campaign status must show “open.” ✓ If Elsa shows other open action(s), inform your customer so that the work can also be completed at the same time the vehicle is in the workshop for this campaign.
Problem Description	The Environmental Protection Agency and California Air Resources Board have determined that Audi A3 vehicles equipped with a 2.0L 4-cylinder TDI engine do not comply with applicable emissions regulations. The emissions control systems on the vehicles will not control emissions under off-cycle conditions as effectively as during the federal test procedure. The extent of the emissions increase under off-cycle conditions depends upon how the vehicles are driven.
Corrective Action	Install updated emissions control system parts and software, install a TDI Emissions Modification – Proof of Completion Label and install a Supplemental Vehicle Emissions Control Information Label. At this time, affected new and used vehicles in dealer inventory are not included in this emissions modification release. If the vehicle has been modified by the customer prior to receiving the emissions modification in a manner that may yield a non-compliant emissions system (for example, removal of a catalyst, installation of parts that impact emissions or emissions-related parts, or modifications to the ECU or computer software of the vehicle), Audi may not be able to perform the emissions modification until the customer corrects such modification.
Parts Information	1K0254402AX (NOx Catalyst), 8P0298101A (Base Kit 1) Parts will be allocated prior to owner notification. If allocated parts have been used and your dealership is at the weekly Upper Order Limit, please submit the backordered sales document number to upperorderlimits@audi.com to have additional parts released.
Code Visibility	On or about August 11, 2017, this campaign code will show open on affected vehicles in Elsa. On or about August 11, 2017, affected vehicles will be identified with this campaign code in the VIN Lookup tool at www.audiusa.com .
Owner Notification	Owner notification took place on August 05, 2017.
Loaner Vehicle	Customers are eligible to receive a loaner vehicle. Please refer to the warranty extension bulletin AWA 17-10 for claiming instructions.

**Emissions Campaigns
Requirements
(CALIFORNIA ONLY)**

The California Air Resources Board and the Department of Motor Vehicles (DMV) require emissions-related campaigns to be completed prior to vehicle registration renewal. When campaign work is done you must provide the owner with a signed "Vehicle Emission Recall – Proof of Correction" certificate (RC EMISCAVWAWU). Order certificates online via the Compliance Label Ordering portal at www.accessaudi.com.

Additional Information

Please alert everyone in your dealership about this action, including Sales, Service, Parts and Accounting personnel. Contact Warranty if you have any questions.

Fill out and affix the appropriate TDI Emissions Modification – Proof of Completion Label and the appropriate Supplemental Vehicle Emissions Control Information Label after work is complete. ***Additional shipments will be released based on the volume of completed repairs claimed through SAGA. The parts will not be available for order through the website at this time.***

Claim Entry Instructions

After campaign has been completed, enter claim as soon as possible to help prevent work from being duplicated elsewhere. Attach the Elsa screen print showing action open on the day of repair to the repair order.

If customer refused campaign work:

- ✓ U.S. dealers: Submit the request through Audi Warranty Online under the Campaigns/Update option.

Service Number	23U7									
Damage Code	0099									
Parts Vendor Code	002									
Claim Type	Sold vehicle: 7 10									
Causal Indicator	Mark Base Kit I as causal part*									
Vehicle Wash and Loaner	Wash: Do not claim wash under this action Loaner: Refer to the warranty extension bulletin AWA 17-10 for claiming instructions									
Criteria I.D.	8P									
	Install <u>Base Kit I components</u> , install NOx catalyst, perform software update, and install a supplemental Vehicle Emissions Control Information label and TDI Emissions Modification Label. Labor operation: 2360 23 99 270 T.U.									
	<table border="1"><thead><tr><th>Quantity</th><th>Part number</th><th>Description</th></tr></thead><tbody><tr><td>1.00</td><td>8P0298101A</td><td>Base Kit I*</td></tr><tr><td>1.00</td><td>1K0254402AX</td><td>NOx Catalyst</td></tr></tbody></table>	Quantity	Part number	Description	1.00	8P0298101A	Base Kit I*	1.00	1K0254402AX	NOx Catalyst
Quantity	Part number	Description								
1.00	8P0298101A	Base Kit I*								
1.00	1K0254402AX	NOx Catalyst								
	*Labels are sent free of charge. They cannot be charged to this campaign.									

At this time, affected new and used vehicles in dealer inventory are not included in this emissions modification release.

NOTE

Damages resulting from improper repair or failure to follow these work instructions are the dealer’s responsibility and are not eligible for reimbursement under this action.

Required Parts

Quantity	Part Number	Part Description
1	8P0 298 101 A	Base Kit I
1	1K0 254 402 AX	NOx Catalyst
1	03L 010 005 G	Supplemental Vehicle Emissions Control Information Label
1	CAMPTDI 2016_1B	TDI Emissions Modification – Proof of Completion Label

Labels are sent free of charge. Additional shipments will be released based on the volume of completed repairs claimed through SAGA. Labels will not be available for order through the website at this time.
For any additional inquiries contact labelrequest@audi.com.

Required Tools



- VAS6150X – Diagnostic Tester (or equivalent)
- VAS5054X – Remote Diagnosis Head (or equivalent)

The repair information in this document is intended for use only by skilled technicians who have the proper tools, equipment and training to correctly and safely maintain your vehicle. These procedures are not intended to be attempted by "do-it-yourselfers," and you should not assume this document applies to your vehicle, or that your vehicle has the condition described. To determine whether this information applies, contact an authorized Audi dealer. ©2017 Audi of America, Inc. All Rights Reserved.



- GRX3000VAS – Battery Tester/Charger



- Socket 22mm –T10491–



- Torque wrench -V.A.G 1331- (or equivalent)



- Torque wrench -V.A.G 1332- (or equivalent)

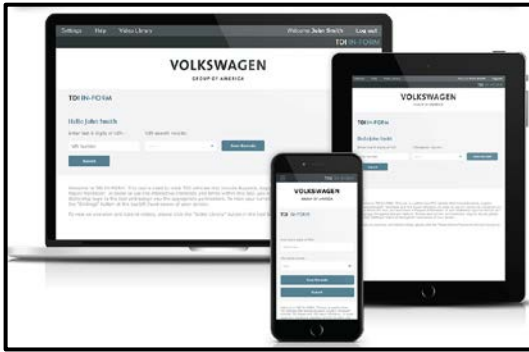

- Service Modification Validation Web App
- tdi-inform.track360.com

TIP

This web application is compatible with desktops, laptops, Apple and Android mobile devices running the most current versions of FireFox, Chrome, Safari, or Explorer as well as iOS 9+ on iPads and iPhones.

NOTE

RISK of Non-payment!

Not using the IN-FORM tool to document and validate the modification will stop the processing of payment for your dealership even if the modification has been completed.

Look for the image below to indicate labor operations, parts, or labeling that requires IN-FORM tool image documentation.



Emissions Modification Instructions

Section A - Check for Previous Emissions Modification

TIP

If the TDI Emissions Modification – Proof of Completion Label (CAMPTDI 2016_1B) is present, no further work is required.

Applicable criteria ID(s)	Campaign/Action Status
01 ← 2	Open ← 1

EXAMPLE

- Enter the VIN in Elsa and proceed to the “Campaign/Action” screen.

TIP

On the date of modification, print this screen and keep a copy with the repair order.

- Confirm the Campaign/Action is open <arrow 1>. If the status is closed, no further work is required.
- Note the Applicable Criteria ID <arrow 2> for use in determining the correct work to be done and corresponding parts associated.
- Check for other Open campaign actions <red arrow above>.
- Other Open campaign actions must be completed prior to releasing the vehicle to the customer.

Vehicle data
VIN: 3VWTL7AJXXXXXXX

Serial number	Campaign/Action	Start	Designation	Repair date	Criteria	Campaign/Action Status
1	20R9	2012-07-10	S-SERV_ACT - "Diesel Fuel Only" Information	2012-07-31	02	Closed
2	23U7	2011-10-04	A-RECALL - Diesel Fuel Injection Lines		01, 02	Open
3	23O6	2015-04-07	S-SERV_ACT - ECM Software Update		01	Open

Example

NOTE

At this time it is required to complete this action in conjunction with **Campaign 23W1**. Campaign 23U7 requires the condition of the Heated O2 Sensor -G39- to be verified **BEFORE** beginning the flash operations contained in this action.

CAMPAIGN 23W1 MUST BE COMPLETED BEFORE BEGINNING THE 23U7 CAMPAIGN!

Refer to **Campaign 23W1** at this time, and complete that action before continuing.

Proceed to Section B

Section B – Check for Service Initiation

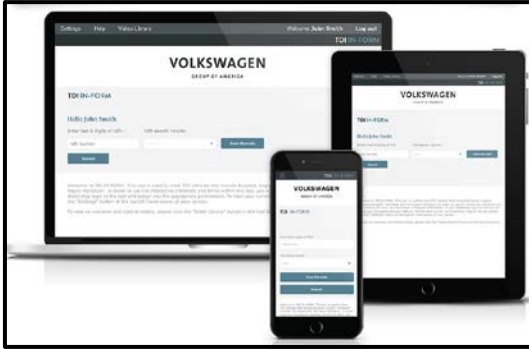

NOTE

RISK of Non-payment!

Not using the IN-FORM tool to document and validate the modification will stop the processing of payment for your dealership even if the modification has been completed.

Look for the image below to indicate labor operations, parts, or labeling that requires IN-FORM tool image documentation.



NOTE

RISK of Non-payment!

Ensure that the “check mark” <arrow> is present prior to beginning any work.

Description:			
2015 Passat Sedan 4D SE TDI 14			
Brand:	VIN:	Transmission:	Repair Type:
Volkswagen	000000000000000000	Automatic	Gen 3
Dealer Name:	Dealer Code:	Region:	Area:
Anytown	N/A	N/A	N/A

Please select a form below to continue.

- Service Modification Documentation and Validation
- Service Initiation Form
Status: Complete | Date: 12/20/2016
- Service Modification Documentation Form
Status: Not Initiated
- Service Modification Manager Validation Form
Status: Not Initiated
- Service Delivery Confirmation
Status: Not Initiated

- Ensure the Service Initiation Form has a “check mark” <arrow>.
 - If the Service Initiation Form does not have a “check mark” <arrow>, immediately contact your Service Consultant to complete the initiation.
 - If “check mark” <arrow> is present, initiate Service Modification Documentation Form and continue work.

DO NOT proceed with any work unless you can initiate the Service Modification Documentation Form.

Proceed to Section C

Section C – Check for Pre-existing conditions, Vehicle Modifications, and MIL light on



- Perform a visual inspection of the intake, exhaust, and emissions systems.
 - If the visual inspection of the intake, exhaust, or emissions equipment reveals damage or concerns, **STOP**, create an ATA ticket and contact the Audi Technicians Helpline.
 - If the visual inspection of the intake, exhaust, or emissions equipment reveals no damage or concerns, continue the work procedure.



- Check for vehicle modifications from original equipment.
 - If vehicle modifications from original equipment related to emissions components are found, **STOP**, create an ATA ticket and contact the Audi Technicians Helpline.
 - If vehicle modifications from original equipment related to emissions components are not found, continue the work procedure.



- Check for illumination of the MIL <arrow>.
 - If MIL is illuminated, **STOP**, create an ATA ticket and contact the Audi Technicians Helpline.
 - If MIL is not illuminated, continue the work procedure.

i TIP
<ul style="list-style-type: none">• ATA cases regarding MIL ON conditions require a GFF diagnostic log to be uploaded at the time of first contact.• The purpose for this step is to document vehicle condition prior to initiation of this action and does not authorize the repair of any pre-existing conditions.

Proceed to Section D

Section D – Emissions Kit Installation

NOTE

-Before beginning the steps outlined in this action-

Verify that Campaign **23W1** has been completed. The Campaign 23W1 refers to replacement of the airbox Snow Flap, and checking (and if required, replacement of) the O2 Sensor -G39-. The TDI IN-FORM Tool requires the upload of a photograph of the replaced Snow Flap. Verify that the Snow Flap has been replaced and photographed. If the O2 Sensor -G39- was replaced, verify that the Test Plan for resetting the O2 Sensor Learned Values has been run and completed before continuing this procedure.

- Open hood.
- Raise vehicle on hoist.
- Unscrew nuts <arrows> and pull underbody cladding down slightly.

TIP

A wedge could be placed between vehicle body and cladding to allow more work space.

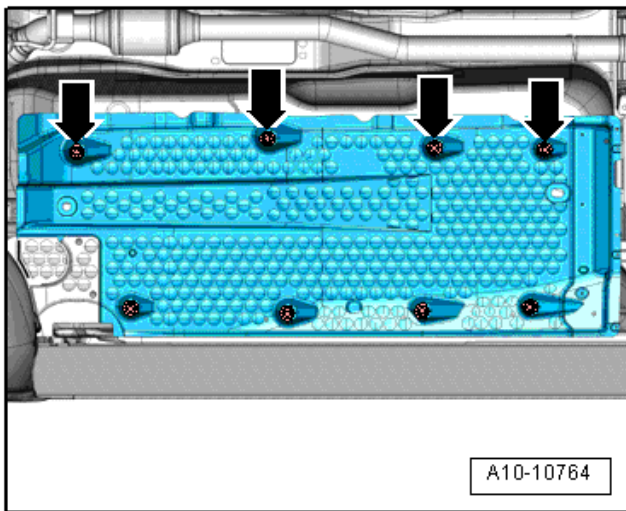

- Disconnect »brown« connector for oxygen sensor after catalytic converter -G130- <2>. Remove plug from retainer.
- Open fasteners for heat shield and pull connector <1> off exhaust door control unit -J883- and thread wiring out of retainers <arrows>.

TIP

Take a photo of this area now for help with harness routing during reinstallation later.

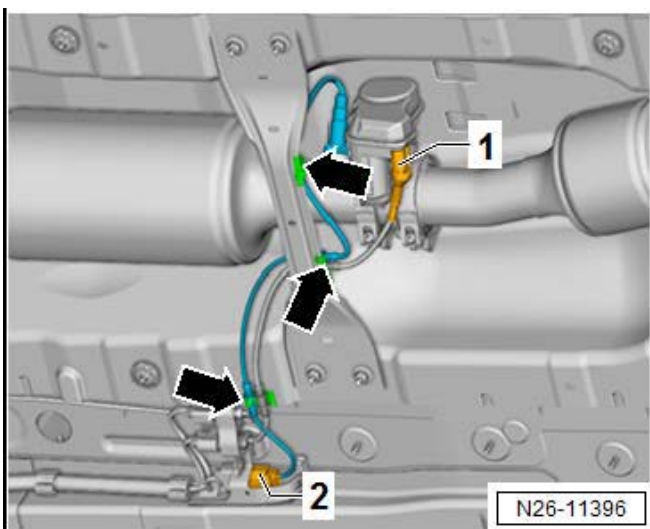

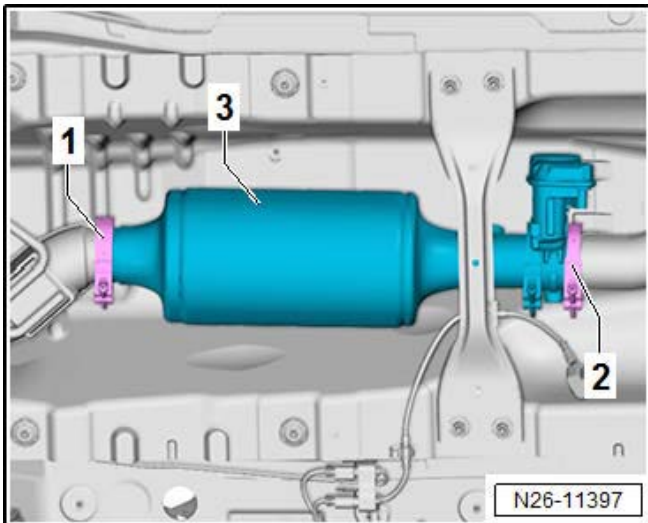

- Loosen clamps <1 and 2> and remove NOx storage catalytic converter together with exhaust door control unit -J883-.

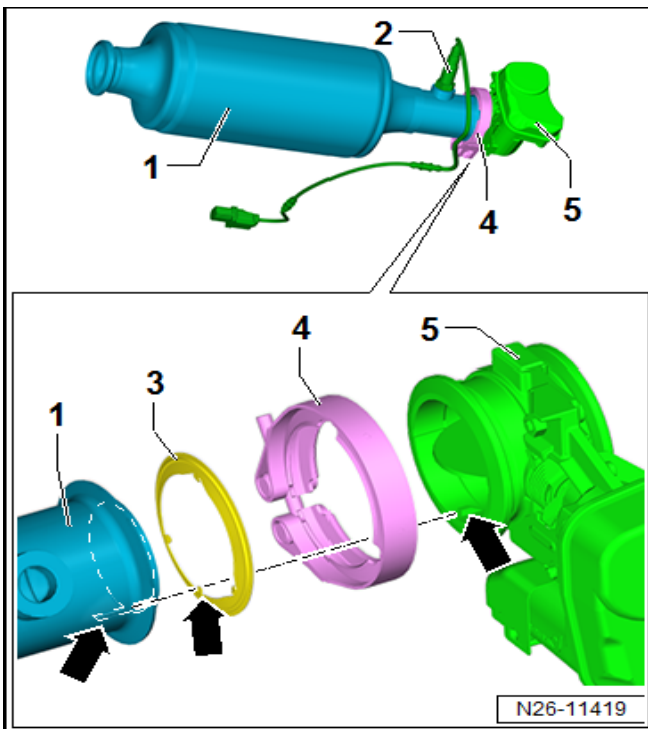

- Screw new oxygen sensor after catalytic converter -G130- <2> into new NOx storage catalytic converter <1> and tighten to 52 Nm using socket, 22 mm -T10491-.
- Set new exhaust door control unit -J883- <5> with new seal <3> on NOx storage catalytic converter <1>. Note notches <arrows>.

NOTE

Renew all clamps and seals. The clamps before and after the exhaust door control unit are narrower than the clamp connecting the particulate filter to the NOx storage catalytic converter. Ensure that they are correctly allocated.

- Position clamp 1K0 253 725 B <4> and tighten to 7 Nm.
- Place NOx storage catalytic converter together with exhaust door control unit -J883- with new seals in installation position. Note notches at rear connection.

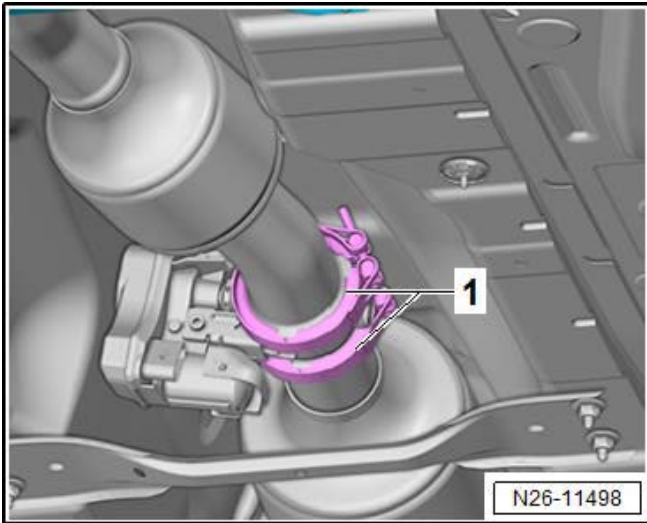

- Position all clamps <1> so that they will not collide with underbody.

NOTE

Install clamps on the exhaust pipe before installing pipe into vehicle. Do not attempt to stretch clamps around pipe once installed, or clamps may fail to seal properly.

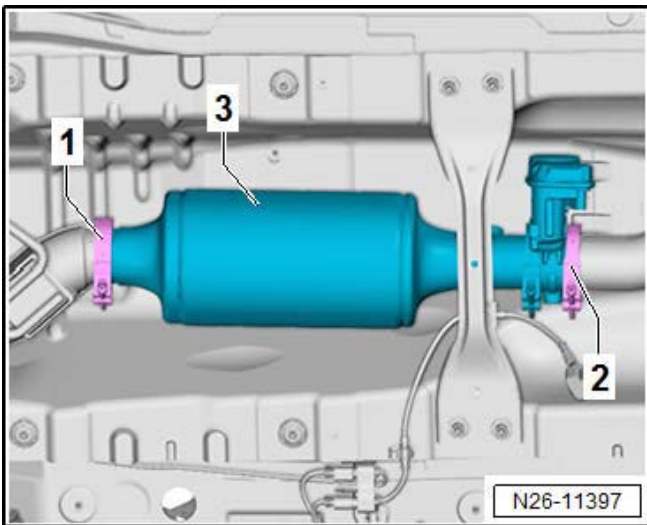

- Set clamp 1K0 253 725 B <2> in place and engage and torque to 7 Nm.
- Set clamp 1K0 253 725 <1> in place and engage. Then tighten to 7 Nm.



- Install the **RED** validation strap to the NOx catalytic converter <as shown> to confirm that the proper part is being returned for core.



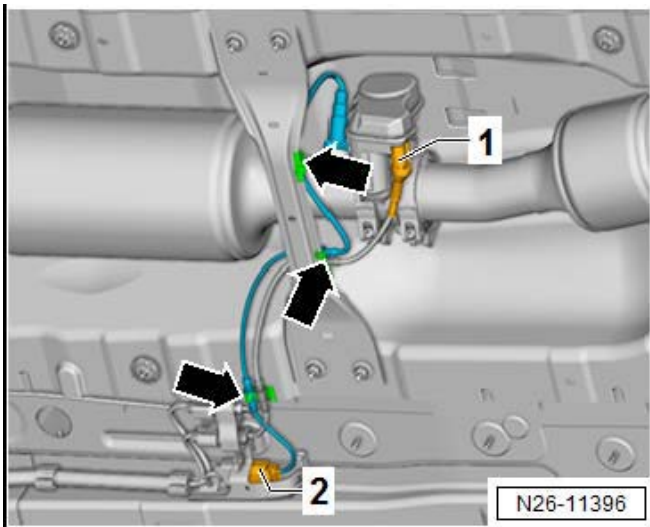

- Connect »brown« connector for oxygen sensor after catalytic converter -G130- <2> and attach to bracket.
- Push connector <1> onto exhaust door control unit. Secure lines in retainers <arrows>.

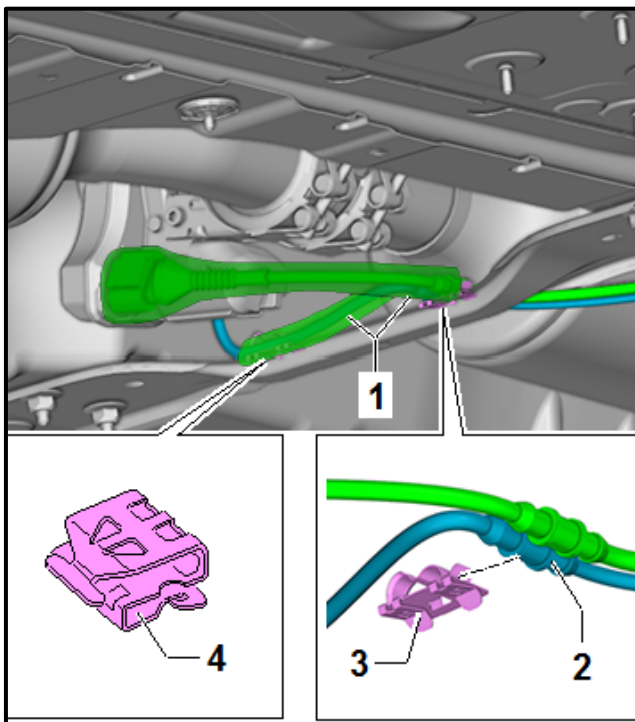

- Wrap new heat insulation mats <1> around wiring and close fasteners.
- Place wires <2> in clips <3 and 4>.

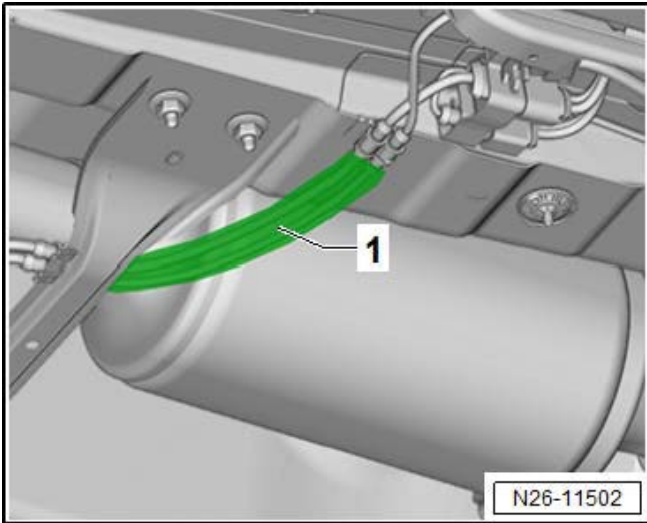

- Wrap new heat insulation mats <1> around wiring and close fasteners.

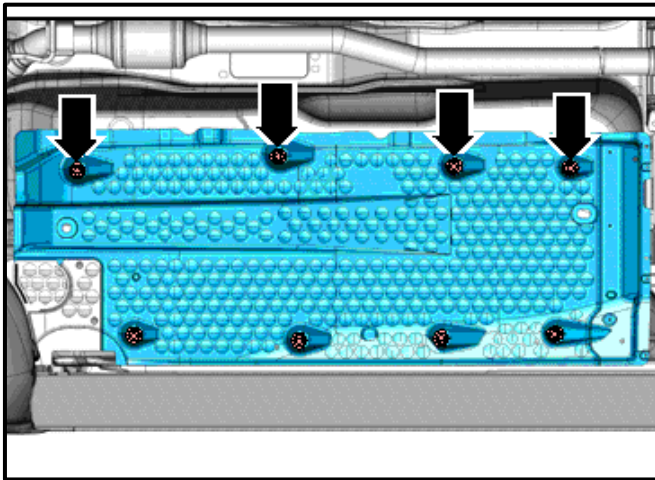

- Press underbody cladding upward and tighten nuts <arrows> to 2 Nm.

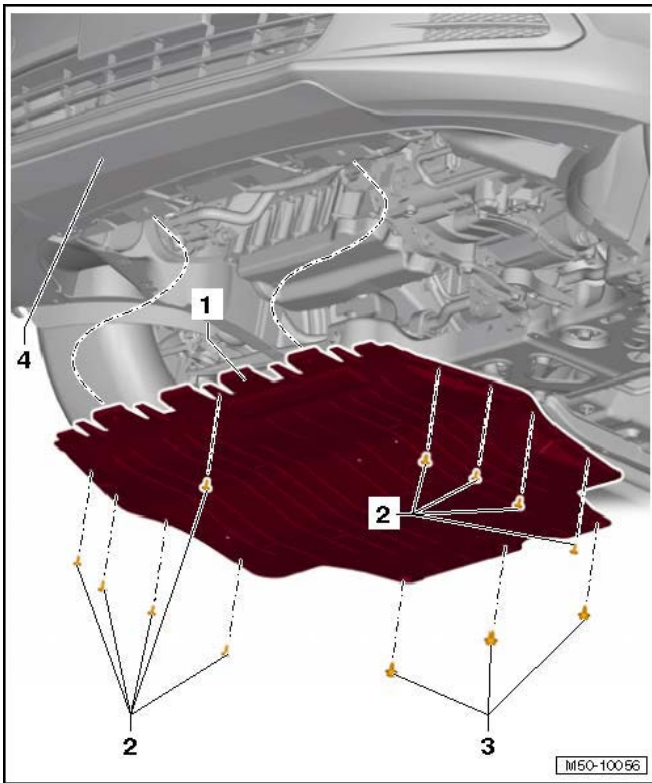

- Remove bolts <2 and 3>.
- Pull noise insulation <1> back, out of front bumper cover <4>.

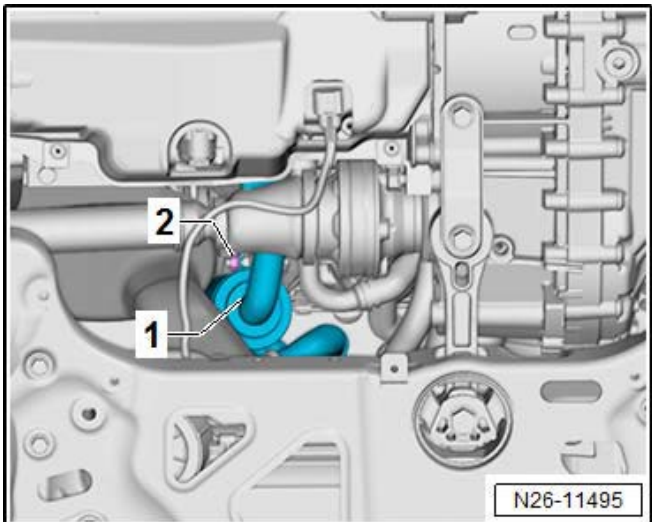

- Remove nut <2> from exhaust gas recirculation filter <1> from below using 13 mm ratchet box wrench (e. g. Snap-on OEXRM13).
- Wrap tape around the tip of a long screwdriver (e.g. Snap-on SDD162 No.2).

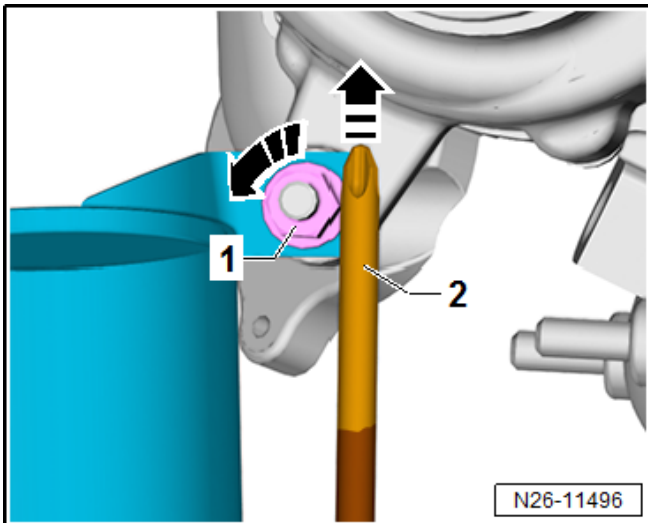

- Apply screwdriver <2> on side of nut <1> and unscrew nut while simultaneously pressing up on nut.

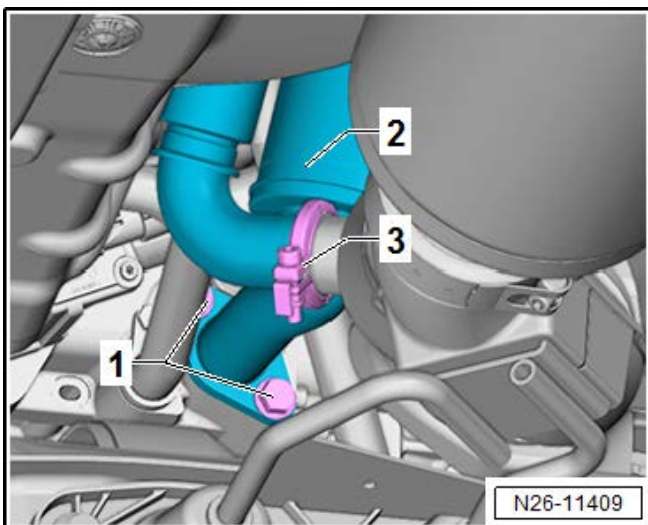

- Open clamp <3> and remove it.
- Remove bolts <1> and remove exhaust gas recirculation filter <2>.

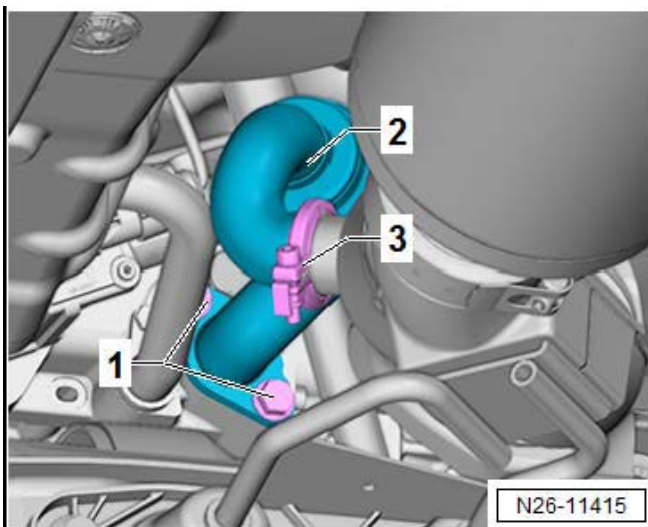

- Set new exhaust gas recirculation filter <2> with new seals in place, screw in bolts <1> and tighten to 9 Nm.
- Position clamp <3> and tighten to 3.5 Nm.

Description	Part number
EGR Filter	1K0 253 120 B
Seal	03G 131 547 H
Seal	1K0 253 115 AG
Clamp	1K0 253 725 F



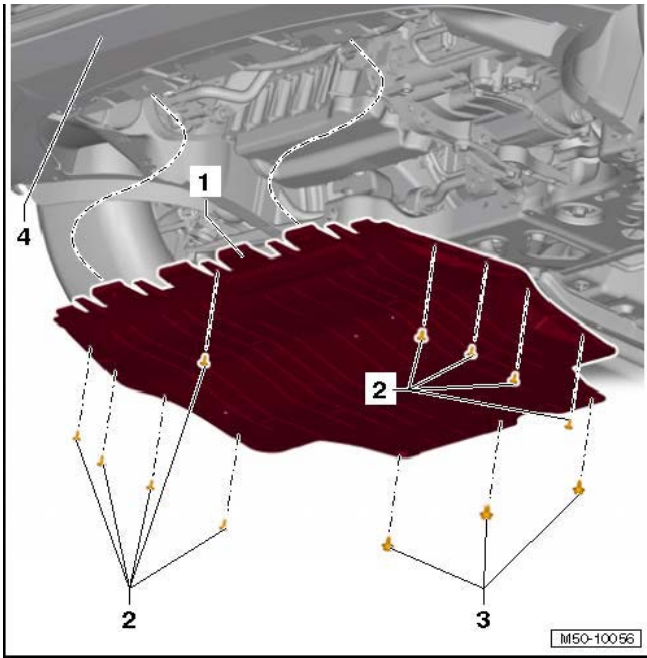

- Push noise insulation <1> forward into front bumper cover <4>.
- Screw in bolts <2> and new bolts <3> and tighten as follows:
 - Bolt <2>: 2 Nm
 - Bolt <3>: 6 Nm (renew)

Proceed to Section E

Section E – Software Update Procedure

NOTE

Prior to launching the VAS Diagnostic Tester and starting an update, ensure the following conditions are met;

- ✓ **The ODIS software is completely up to date.**
 - Refer to the “Alerts” section on ServiceNet home page for the current ODIS version.
- ✓ **The battery charger is connected to the vehicle battery and remains connected for the duration of the software update.**
 - Battery voltage must remain above 12.5 volts for the duration of the software update. Failure to do so may cause the update to fail, which could result in damage to the control module. Control modules damaged by insufficient voltage will not be covered.
- ✓ **The screen saver and power saving settings are off.**
 - Failure to do so may result in the tester entering power save mode during the software update, which could result in damage to the control module.
- ✓ **The VAS Diagnostic Tester is plugged in using the supplied power adapters.**
 - Under no circumstances should the tester be used on battery power alone during the software update. Failure to do so may result in the tester powering off during the update, which could result in damage to the control module.
- ✓ **If using the Bluetooth or WiFi transmitter head, it must be connected to the tester with a USB cable.**

NOTE

Using Bluetooth for this action is PROHIBITED!

Damage caused to electronic components (e.g. ECM, TCM, etc.) during the SVM flash process is not covered.

- Performing a software update using a Bluetooth connection increases the risk of losing connection during the update, which could result in damage to the control module. It also greatly increases the time required to perform the update. Requests for additional time or parts will be denied if the GFF log shows the update was performed using Bluetooth.
- ✓ **The Bluetooth function of the scan tool is physically switched off <see pictures below>.**



VAS 6150 & VAS 6150A
(Front panel behind handle)

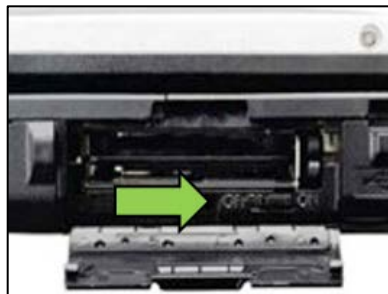

VAS 6150B
(Right side behind WIRELESS door)

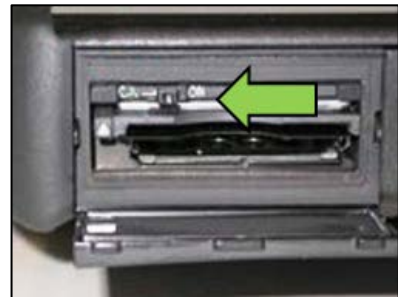

VAS 6150C
(Left side behind SC/EX door)

WARNING

Radiator Fan(s) may cycle ON high speed during the Update Process! There is a serious risk that personal injury may result if contact is made with spinning fan blades. Keep hands and all objects away from Radiator Fan(s) during Update Process!

TIP

To Update-Programming using SVM, review and follow instructions in Technical Bulletin 2014603: *Software Version Management (SVM) Operating Instructions*.

The SVM Process must be completed in its entirety so the database receives the update confirmation response. A warranty claim may not be reimbursed if there is no confirmation response to support the claim.

Things to check before starting Software Version Management (SVM):

- ✓ Check the icon <arrow> within the ODIS software that you have a LAN connection.



- ✓ Within the Connection Tab, verify that the Connection type(s) display "Internet" <as shown>.

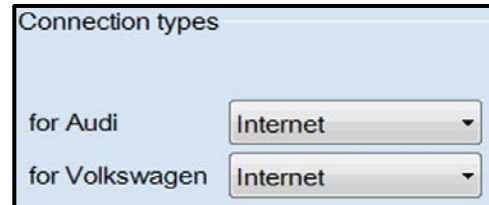

- ✓ Start a connections test <arrow> and verify that all connections pass.

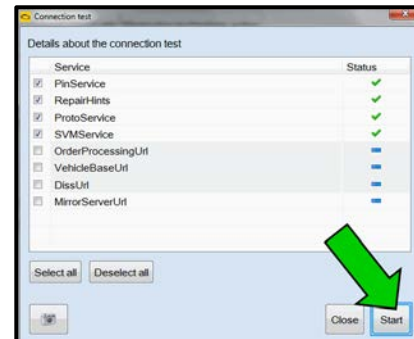



- Open the hood.
- Open the battery cover.
- Attach the GRX3000VAS Tester/Charger to the vehicle battery.
- Switch the ignition on.
- Apply the parking brake.
- Switch the headlights off.
- Connect the VAS6150X Diagnostic Tester (or equivalent) to the vehicle.
- Start the ODIS program.

NOTE

-Before beginning the steps outlined in this action-

Verify that Campaign **23W1** has been completed. The Campaign 23W1 refers to replacement of the airbox Snow Flap, and checking (and if required, replacement of) the O2 Sensor -G39-. The TDI IN-FORM Tool requires the upload of a photograph of the replaced Snow Flap. Verify that the Snow Flap has been replaced and photographed. If the O2 Sensor -G39- was replaced, verify that the Test Plan for resetting the O2 Sensor Learned Values has been run and completed before continuing this procedure.

NOTE



All TDI flashes **MUST** be completed during a single, standalone ODIS Diagnostic Session. You **MUST** fully complete this campaign and send all GFF Paperless logs before beginning any other campaigns or operations. You **MUST** also conclude any other campaigns or operations that have been started and end the corresponding diagnostic session and send all GFF Paperless logs before beginning this operation. Failure to independently separate the ODIS diagnostic session for this campaign will cause problems updating the FAZIT server in Germany and will delay if not negate the payment of the emissions modification.

IMPORTANT!

If there are any ODIS "Hot-Fix" patches installed, they **MUST** be removed from the scan tool before beginning this operation. ODIS "Hot-Fix" patches may affect the flash process.





- Confirm that scan tool is communicating with the diagnostic head by USB <Green Arrow>.
 - If the Bluetooth symbol is shown <Red Arrow> then disconnect the diagnostic head from the vehicle and reconnect the USB cable to the diagnostic head and then reattach to the vehicle.



! NOTE

For the duration of the flash, the following is required to keep the BUS system active during the flash process:

- Driver side door open
- Doors unlocked
- Hazzard flashers in the "On" position



! NOTE

KESY Vehicles!

- If loss of communication between the reader coil and the key occurs during the flash, it may damage a control module.
- If equipped with a removable reader coil cap, it is **REQUIRED** to remove the reader coil cap and insert the key into the reader coil, or secure the key in close proximity to the reader coil throughout the flash process.
- If the reader coil cap is not removable, it is **REQUIRED** to secure the key to the steering column in close proximity to the reader coil using a residue-free adhesive or tape, an elastic cloth or stretch bandage, or other improvised retaining device.



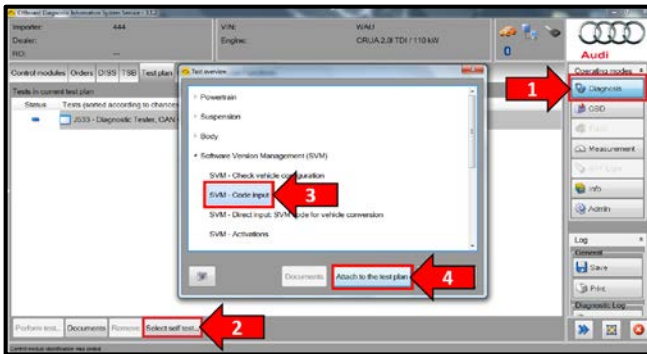

- Upon ODIS startup, select “Diagnosis” <arrow 1>.
- Select “Self Test” <arrow 2>.
- Select “Software Version Management”, then select “SVM Code input” <arrow 3>.
- Select “Attach to the test plan” <arrow 4>.

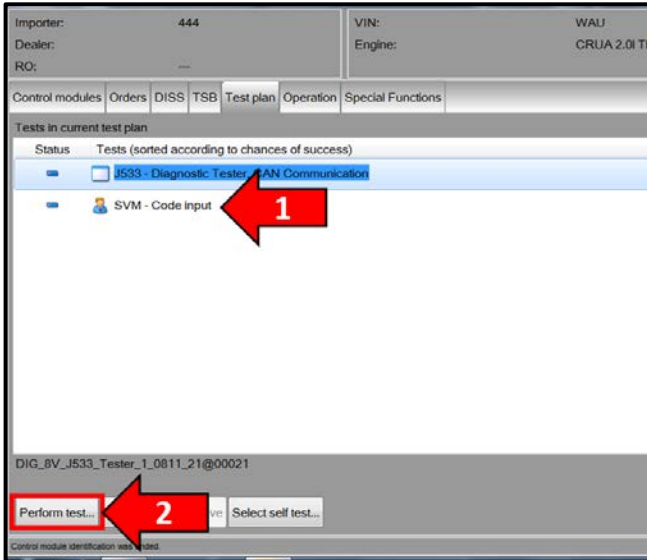

NOTE

RISK of Scan Tool Damage!

Do not leave the scan tool on the windshield during the flash process, as it is possible that the windshield wipers may cycle.

- From the Test plan screen, Select “SVM - Code input” test plan <arrow 1>, then select “Perform test” <arrow 2>.
- Follow the on-screen prompts.

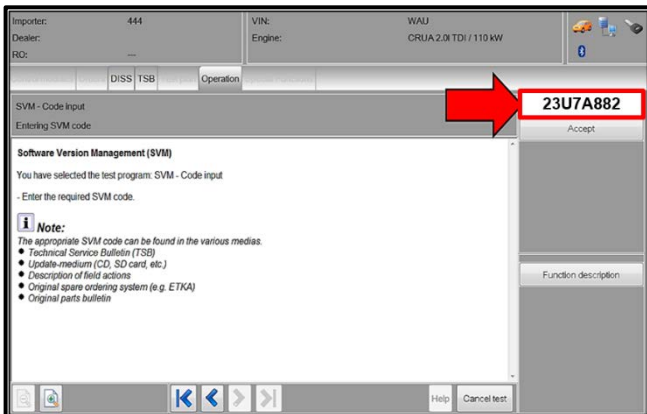

NOTE

Using Bluetooth for this action is PROHIBITED!

Damage caused to electronic components (e.g. ECM, TCM, etc.) during the SVM flash process is not covered.

- Enter SVM code “23U7A882” <arrow>, then select “Accept”.
- Follow the on-screen prompts until completion of the flash operation.



- If you receive the message “Replace the heated oxygen sensor -G39- (before catalytic converter), Refer to the Repair Manual, Repair Group 23” <arrow 1> after the Test Plan O2 Sensor self-check routine completes, **disregard** this message at this time. There is **NO** action required in regards to this campaign, as repair and claiming instructions have already been addressed in detail during the **23W1** campaign.
- Select “Complete/Continue” <arrow 2>.

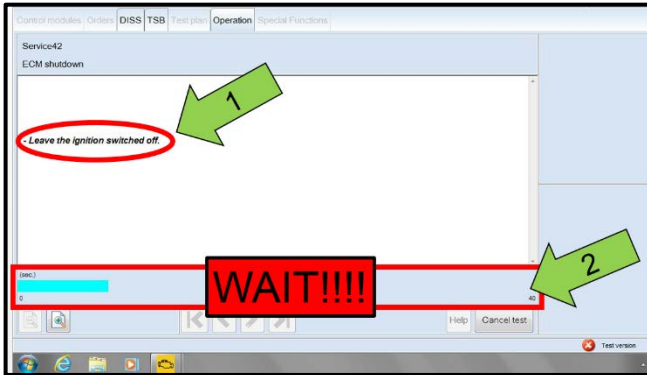

NOTE

- It is **IMPERATIVE** that **ALL** of the ignition cycle on/off delay requests are fulfilled in their entirety during this flash process <arrow 1>.
- Failing to wait for the ignition on/off timing cycle to complete (progress bar and countdown timer <arrow 2>) before cycling the ignition on/off **MAY** damage a control module.
- Damage to control modules as a result of failing to wait the specified time displayed by the progress bar and countdown timer <arrow 2> are **NOT** covered under this action.

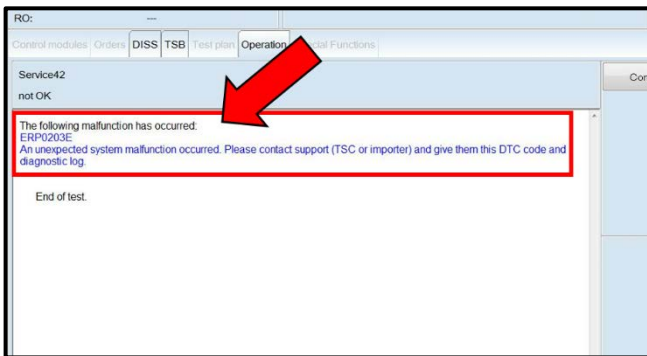

NOTE

In the event of a Flash Malfunction!

In the event of a flash error or malfunction, **STOP**. **DO NOT** exit the ODIS session, disconnect the scan tool, attempt the flash again, or continue further in the test plan.

Create an ATA ticket and allow the Audi Technicians Helpline to provide direction with flash failures.

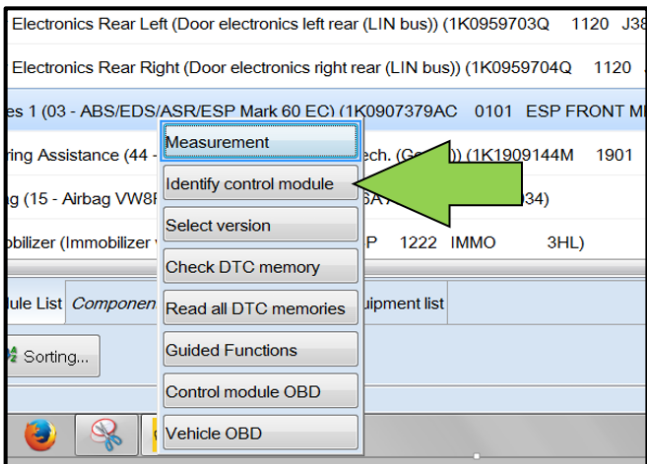

- After the software update is completed and before sending the GFF Log Online:
 - Select the “Control Module” tab.
 - Scroll down and right click on Address Word 0001/ Engine Control Module.
 - Select “Identify Control Module” <arrow>.

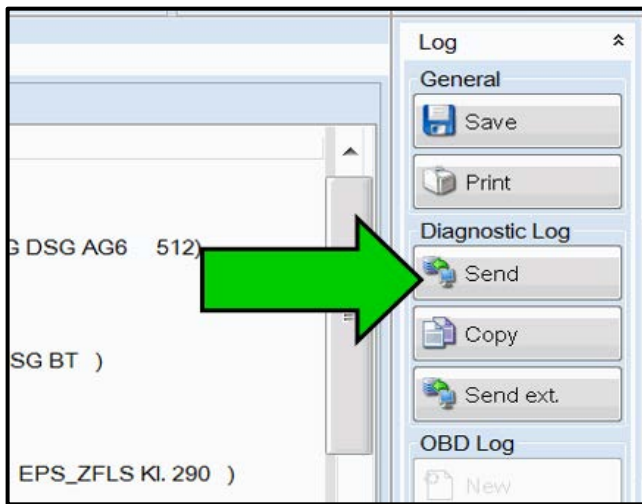

- At the end of the diagnostic session, Select “Send” <arrow> and follow the prompt for sending the log on-line.

NOTE

RISK of Non-payment!

- Diagnosis logs must be sent on-line after the flash process to be considered for reimbursement.
- Verify that no other Campaigns or operations are performed during this ODIS diagnostic session before sending the log, and verify that the Engine Control Module has been re-identified.

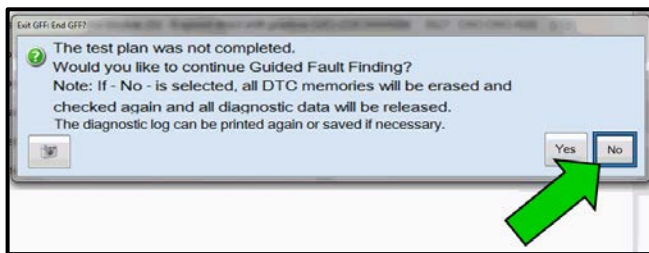

TIP

Technicians may find it helpful to also store the log on a USB stick for back-up.

TIP

When exiting GFF, it is important to select “No” <arrow>.

- Disconnect the VAS tester.
- Switch off and disconnect the battery charger.
- Reinstall the battery cover.
- Release the parking brake.
- Perform test drive.

NOTE

DO NOT drive vehicle without having both new software and new hardware as doing so will damage to the newly installed components.

Proceed to Section F.

Section F – Supplemental Vehicle Emissions Control Information Label

VOLKSWAGEN / AUDI VEHICLE EMISSION CONTROL INFORMATION				
Conforms to Consent Decree Maximum Emissions Modification Limits: 2009-2014 MY Diesel GEN 1				
Emission Levels for Modified Vehicles				
Test	NMOG + NOx g/mi	CO g/mi	HCHO g/mi	PM g/mi
Transmission	Auto / Man	Auto / Man	Auto / Man	Auto / Man
FTP	0.160 / 0.190	4.2 / 4.2	0.018 / 0.018	0.01 / 0.01
Hwy FE test	0.160 / 0.160	4.2 / 4.2	0.018 / 0.018	0.01 / 0.01
SFTP composite	0.250 / 0.260	4.2 / 4.2	0.018 / 0.018	0.01 / 0.01
FTP@1620m	0.360 / 0.390	4.2 / 4.2	0.018 / 0.018	0.01 / 0.01
03L 010 005 G				

Install Supplemental Vehicle Emissions Control Information Label

TIP

- The surface where the label is to be installed must be clean, dry, and free from oil residue prior to installing the label.
- Label must NOT cover any existing label(s).
- Label must be installed in location shown.
- Photo documentation of label installed is required.

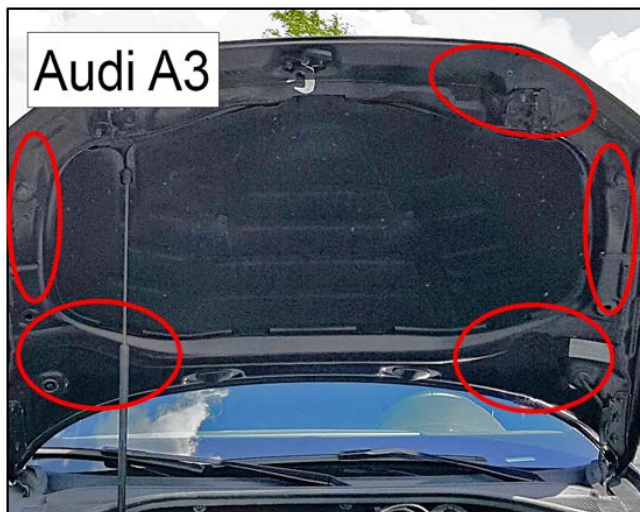

- Open the hood.
- Clean the surface where the label is to be installed <circle>.
- Install the Supplemental Vehicle Emissions Control Information Label, **03L 010 005 G**, in the location shown.
 - Painted surface
 - In a readily visible position on the underside of the hood
 - In as close proximity to the original VECI label as possible
 - In as close proximity (for picture purposes) of the Campaign Completion Label

NOTE

DO NOT Cover existing VECI label!

New Vehicle Emissions Control Information (VECI) label MUST NOT be placed over original VECI label.



Proceed to Section G

Section G – TDI Emissions Modification – Proof of Completion Label

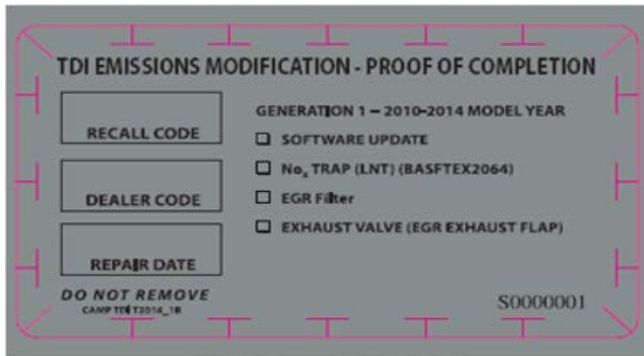

The image shows a rectangular label form with a pink border. At the top, it reads "TDI EMISSIONS MODIFICATION - PROOF OF COMPLETION". Below this, there are three input fields: "RECALL CODE", "DEALER CODE", and "REPAIR DATE". To the right of these fields, it says "GENERATION 1 – 2010-2014 MODEL YEAR" followed by three checkboxes: "SOFTWARE UPDATE", "No_x TRAP (LNT) (BASFTX2064)", and "EGR Filter". Below the checkboxes, it says "EXHAUST VALVE (EGR EXHAUST FLAP)". At the bottom left, it says "DO NOT REMOVE" and "CAMP TDI 2016_1B". At the bottom right, it says "S0000001".

MY 2010-2014 – CAMP TDI 2016_1B

Install TDI Emissions Modification – Proof of Completion Label

TIP

- The surface where the label is to be installed must be clean, dry, and free from oil residue prior to installing the label.
- Label must NOT cover any existing label(s).
- Photo documentation of label installed is required.

- Clean the surface next to the Vehicle Emission Control Information Label where the TDI Emissions Modification – Proof of Completion Label is to be installed.
- Fill out and affix TDI Emissions Modification –Proof of Completion Label, part number **CAMP TDI 2016_1B**.

NOTE

Place the label next to the Vehicle Emission Control Information Label.

- Apply clear overlay (provided).



- Close the hood.

Proceed to Section H (California only).

Proceed to Section I (All without California).

Section H – California Only Requirements

CALIFORNIA ONLY Requirements for Emissions Campaigns Having Customer Notification

The California Air Resources Board and the Department of Motor Vehicles (DMV) require emissions-related campaigns to be completed prior to vehicle registration renewal. **When campaign work is done you must provide the owner with a signed “Vehicle Emission Recall – Proof of Correction” certificate (RC EMIS_CAL VW).** Certificates can be ordered at no cost online via the Compliance Label Ordering portal at www.accessaudi.com.

TIP

Ensure owners are aware of the importance of retaining the completed certificate for their records. It should be mailed to the California DMV only upon request.

Proceed to Section I

Section I – Service Modification Documentation Requirements

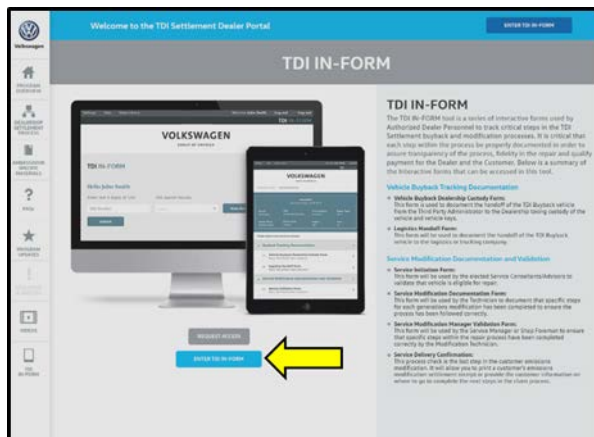

Job Roles Summary:

- *Service Consultant – Initiates validation tool.*
- *Service Technician – Completes service modification requirements.*
- *Manager – Validates the modification was properly completed.*
- *Dealer Representative/Cashier – Prints receipt, fuel economy label and delivers to customer.*
- *Warranty Administrator – Enters claim into the SAGA system.*

TIP

To access the interactive forms go to the TDI Settlement Program microsite on accessaudi.com. Then Select the “TDI IN-FORM” Button from the lower left side of the microsite navigation.

- Enter the “TDI IN-FORM” tool <arrow>.

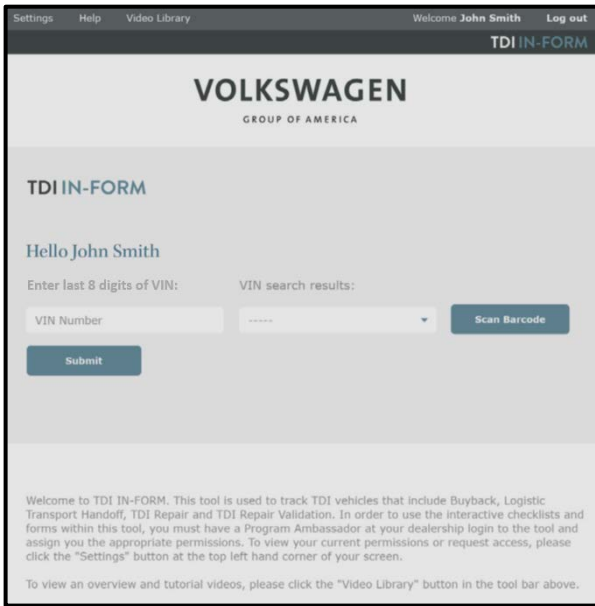

- Enter the VIN for the vehicle that requires documentation.

TIP

The VIN can be manually typed in or using an iPad or iPhone running iOS 9+, the camera can be used to scan the VIN Barcode.

Please note ambient lighting, camera quality, etc. may impact the effectiveness of the VIN scanning feature.

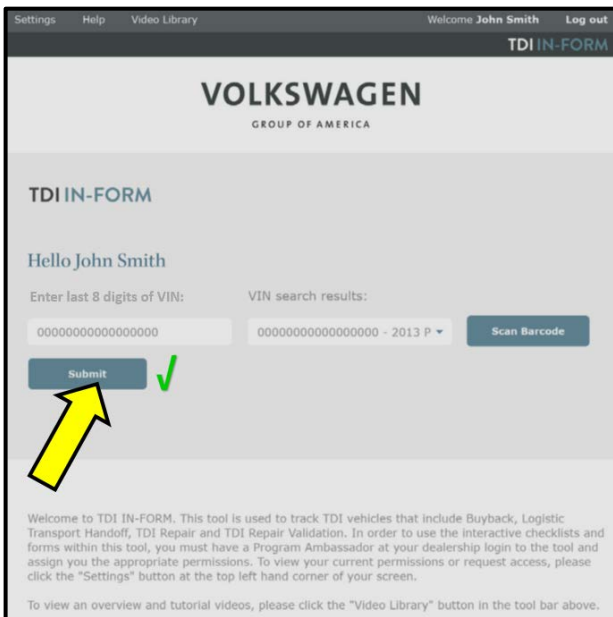

TIP

After the VIN has been entered, the system will automatically validate that it is a TDI VIN. This will be indicated by a green check mark that will appear next to the VIN.

- Validate the VIN is correct for the vehicle, then click the "Submit" button <arrow>.

Settings Help Video Library Welcome John Smith Log out

TDI IN-FORM

VOLKSWAGEN
GROUP OF AMERICA

Enter VIN to Start Interactive Forms

Description:
2013 Passat Sedan 4D SE TDI 14

Brand: Volkswagen	VIN: 000000000000000000	Transmission: Automatic	Repair Type: Gen 2
Dealer Name: Anytown Dealer	Dealer Code: 000000	Region: NER	Area: 1A

Please select a form below to continue.

- Buyback Tracking Documentation
- Service Modification Documentation and Validation
 - Service Initiation Form
Status: Not Initiated | Date: Vestibulum
 - Service Modification Documentation Form** ←
 - Service Modification Manager Validation Form
Status: Not Initiated | Date: Vestibulum
 - Service Delivery Confirmation
Status: Not Initiated | Date: Vestibulum

- Select “Service Modification Documentation Form” <arrow>.
- Follow the on-screen prompts completely.

NOTE

RISK of Non-payment!

Not using the IN-FORM tool to document and validate the modification will stop the processing of payment for your dealership even if the modification has been completed.

TIP

Upon completion of the Service Modification Documentation Form, the Manager must validate the repair in the IN-FORM tool.

Proceed to Section J

Section J – Campaign Stamp

I certify that this campaign
has been performed in strict
accordance with the applicable
Audi repair procedure.

SAGA Code: _____

Technician: _____

Date: _____

Item#: AUD4927ENG

- Once the campaign has been completed, the technician should stamp the repair order.
- Stamps are available for ordering through the Compliance Label Ordering Portal (item# AUD4927ENG).

ALL WORK IS COMPLETE

NOTE

At this time, refer to the ELSA and address any additional open campaigns/recalls.