



# Service Bulletin

File in Section: -

Bulletin No.: 18-NA-377

Date: December, 2018

## TECHNICAL

**Subject:** Front Seat Lateral Movement and/or Click Type Noise While Driving

**Attention:** This bulletin replaces 3 PI's. Please discard PI1183A, PI1376 and PIT5542.

Brand:	Model:	Model Year:		VIN:		Engine:	Transmission:
		from	to	from	to		
Cadillac	Escalade Models	2015	2019			All	All
Chevrolet	Silverado 1500	2014	2014				
GMC	Sierra 1500	2014	2014				
Chevrolet	Silverado, Suburban, Tahoe	2015	2018				
GMC	Sierra, Yukon Models	2015	2018				
Chevrolet	Silverado LD, Silverado 2500/3500, Suburban, Tahoe	2019	2019				
GMC	Sierra Limited, Sierra 2500/3500, Yukon Models	2019	2019				

<b>Involved Region or Country</b>	North America, N.A. Export Regions
<b>Additional Options (RPOs)</b>	
<b>Condition</b>	<p>Customer may comment that the driver and/or passenger seat lower cushion exhibits excessive lateral seat movement combined with a clunk type feeling, or generates a click type noise.</p> <p>This condition occurs when the seat is occupied and the vehicle is being driven on roads with multiple curves or during low speed maneuvers.</p>
<b>Cause</b>	<p>The cause of the condition may be movement between the seat pan front pivot points and the seat frame pivot bar. The plastic attachment points may "stick" then "slip" creating the condition.</p> <p>There may also be excessive clearance between the power seat vertical adjuster actuator and the attachment point on the seat frame.</p>
<b>Correction</b>	<p>Use the steps in the Service Procedure below to lubricate the front seat pan pivot points, add a lateral retainer to the outboard pivot, and install a shim clip between the power seat vertical adjuster actuator and the seat frame (if required) to the affected seat(s).</p>

## Service Procedure

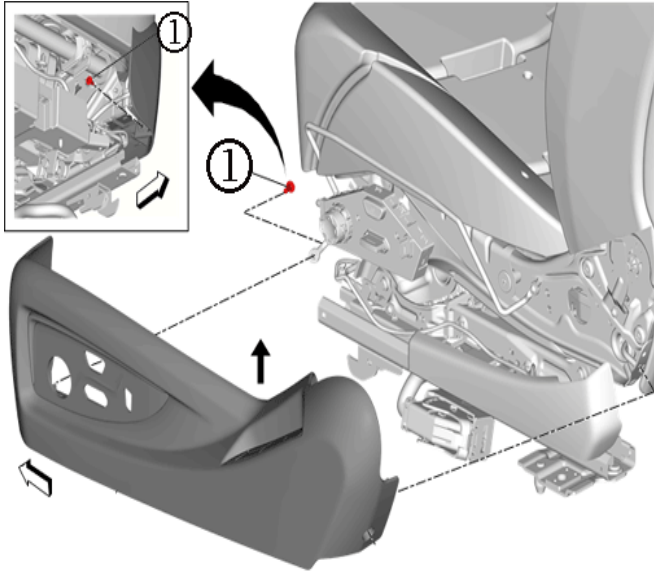

4025118

1. Partially disengage the front seat cushion outer finish cover.
  - Only remove the front seat cushion outer finish cover front fastener (1) as show above.
  - Disengage the cover by pulling upward near the retainer clip locations.

**Caution:** The front seat cushion outer finish cover rear fastener is still installed, take caution when disengaging the cover.

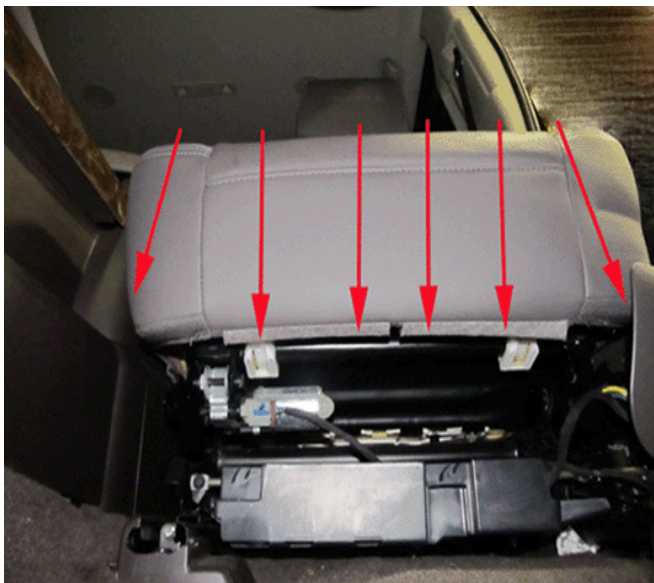

4025189

2. Partially remove the forward half of the lower seat cushion cover and pad on the affected seat.

**Note:** It is NOT necessary to completely remove the seat cover and pad, only the side and front retainers need to be released. The rear of the cover can remain attached.

- Move the seat into a position where the front and inboard side of the seat cover can be accessed.
- Disengage the front, left and right J-channel retainers from the seat cushion frame as shown above.

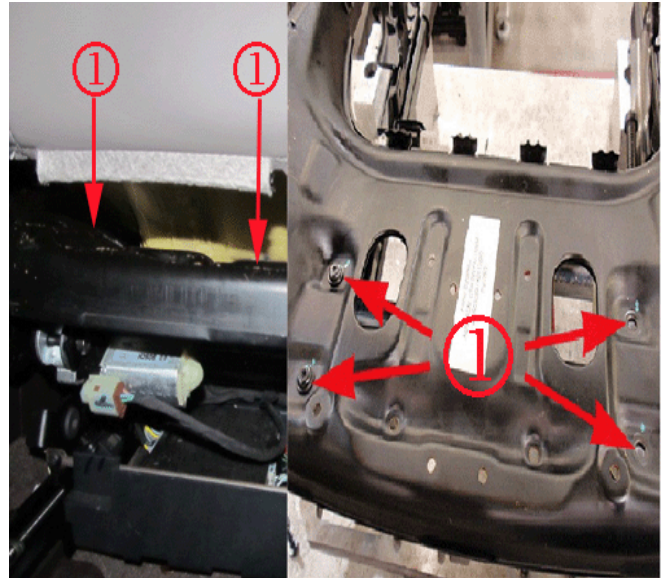

4024923

3. Remove the four screws that attach to the two pivot blocks to the seat pan.

**Note:** Lift the seat pan to provide additional working access.

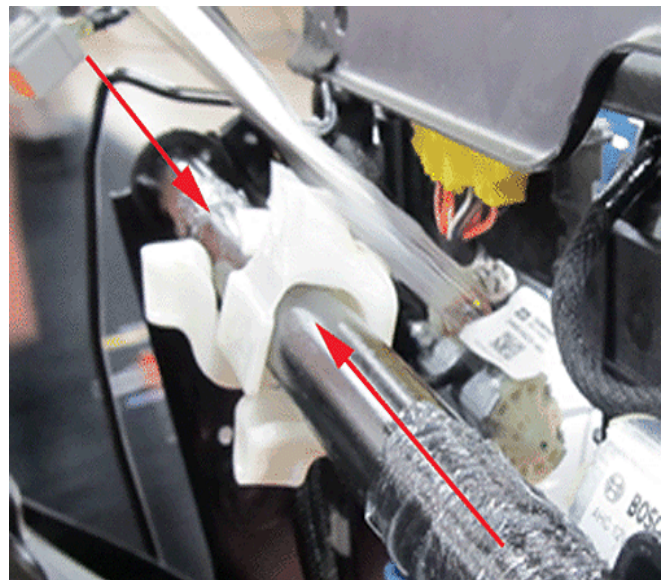

3967501

**Important:** DO NOT attempt to remove the pivot blocks from the seat. Possible damage to the pivot blocks may result.

4. Slide the two pivot blocks to the center of the seat, to allow for applying grease to the pivot bar.



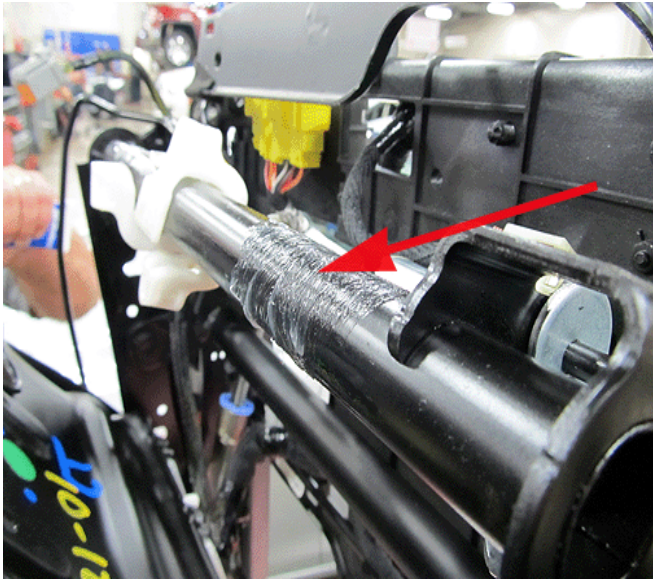

3619960

5. Using a small brush, apply GM Super Lube, GM P/N 12371287 (In Canada, use 10953437) as shown. Ensure the complete contact surface is coated.

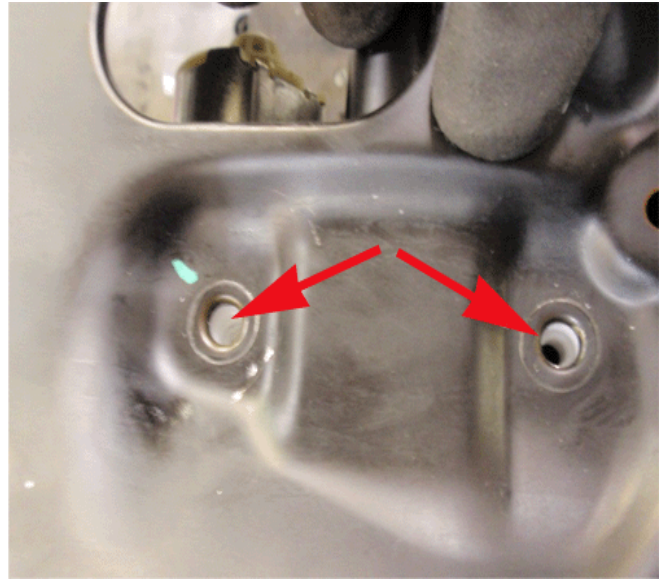

3619963

7. Align the holes in the seat pan with the holes in the pivot blocks.

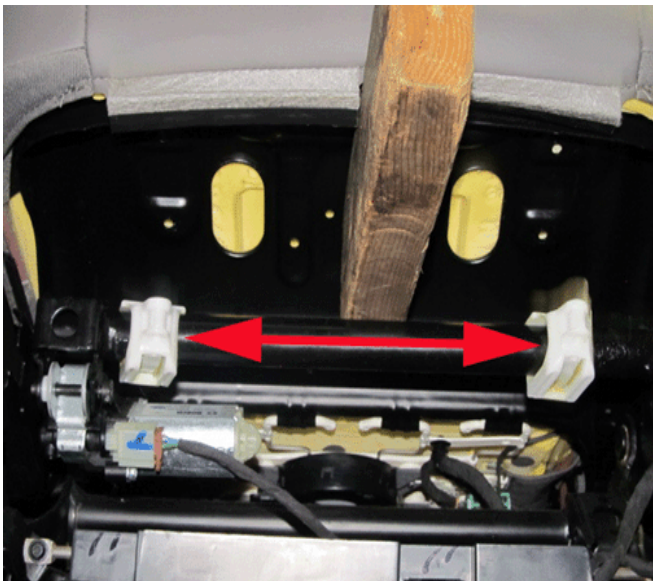

4025748

6. Move the pivot blocks back out to their original position.



3619964

8. Hand start the four screws; Do NOT tighten.

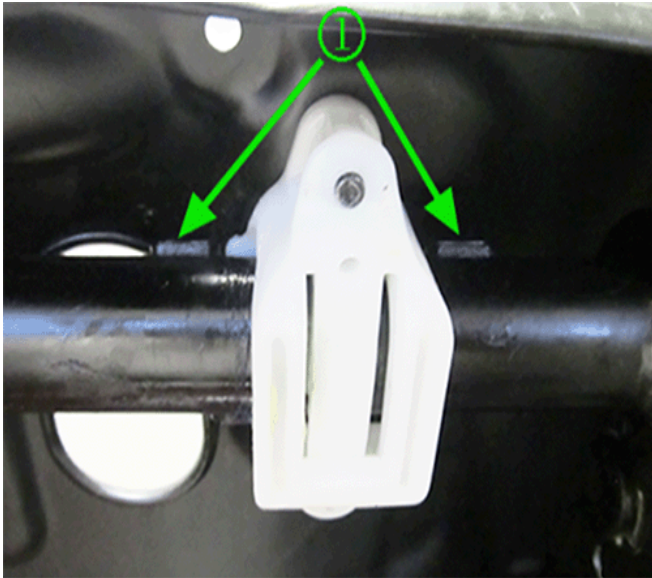

4649728

**Note:** For some 2016 and newer model years, an updated seat frame design incorporates welded brackets (1) to the seat frame pivot bar, on each side of the white guide block. This helps to reduce the excessive lateral seat movement.

**Important:** Regardless of the model year, in some cases, even with the updated seat frame design, there still could be excessive clearance between the welded brackets (1) and the white guide block. This will cause excessive lateral seat movement.

9. If the excessive lateral seat movement is verified, the front seat lateral retainer (GM PN 13405675) can be installed to correct this condition.

**Important:** The installation procedure of the lateral retainer, will depend on which seat frame design the vehicle has. In order to be able to correctly install the front seat lateral retainer on the new updated seat frame design, a modification **MUST** be done.

10. Inspect the seat frame for existence of the added welded brackets (1):
  - If **NO** welded brackets are visible on the seat frame, jump ahead to step #12 and install the lateral retainer.
  - If the welded brackets are visible on the seat frame, continue on to step #11, which includes a modification step.

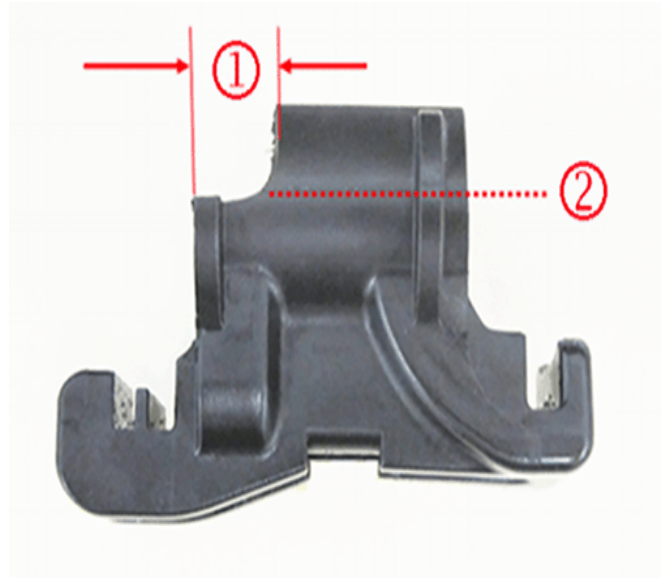

4649794

11. It will be necessary to remove plastic material from the top side of the guide end of the lateral retainer to enable installation. Using a grinder, or similar tool, remove approximately 10 mm (0.40 in) of material (1) from the top, down to the mold seam line (2), as shown above.

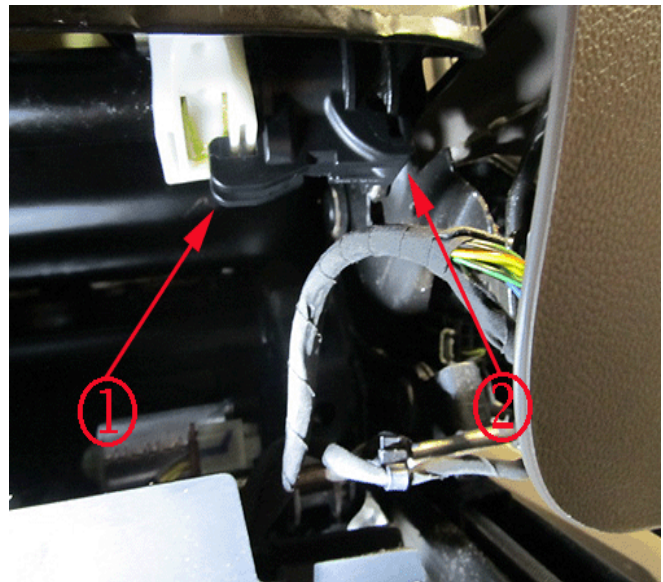

4031854

12. Install the lateral retainer to the outboard end of the pivot bar as shown above. Ensure the retainer is fully seated around the pivot bar and on the guide block.

**Note:** The lateral retainer can only be installed one way.

- The double slotted side (1) of the lateral retainer attaches to the pivot block.
- The single slotted side (2) of the lateral retainer attaches to the end of the pivot bar.



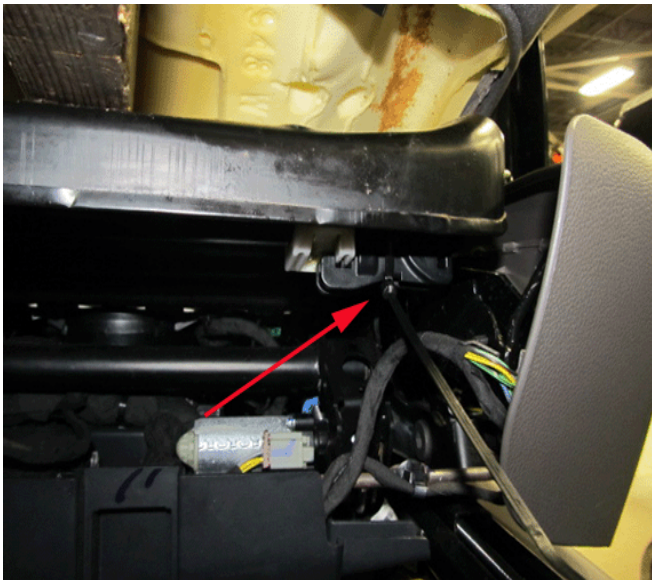

4031857

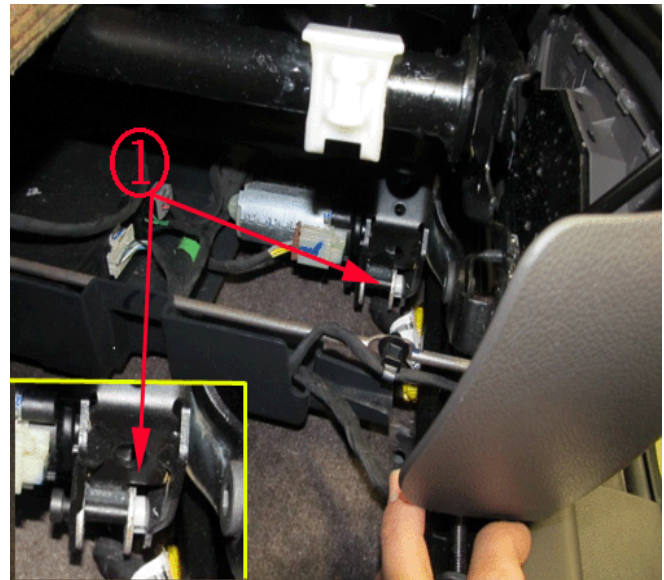

4031883

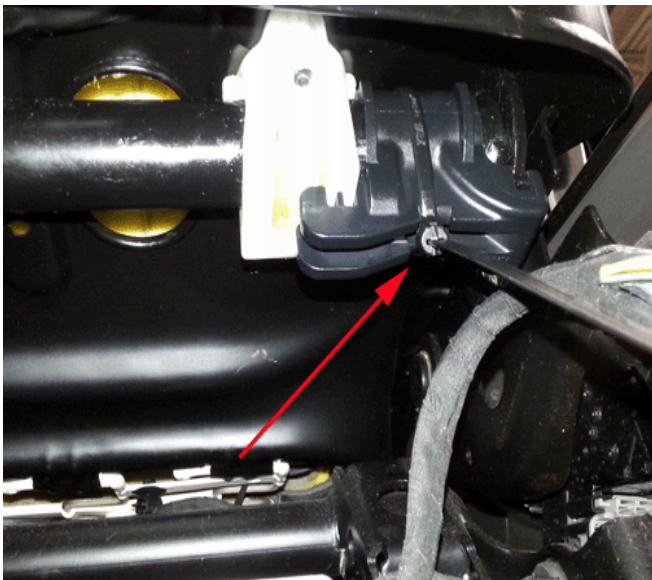

4032701

13. Install a nylon tie strap around the retainer as shown above. Trim the excess tie strap material.
14. Tighten the four screws for the pivot blocks.
15. Operate the front of the seat up and down to verify the welded bracket does not interfere with the front seat lateral retainer.
16. Wipe off any excess lubricant.
17. Re-install the forward portion of the lower seat cushion cover on the affected seat. Ensure all side and front retainers are fully engaged to the seat frame.

18. Locate the power seat vertical adjuster actuator attachment to the seat frame.
19. Inspect for the presence of the shim clip (1) as shown.

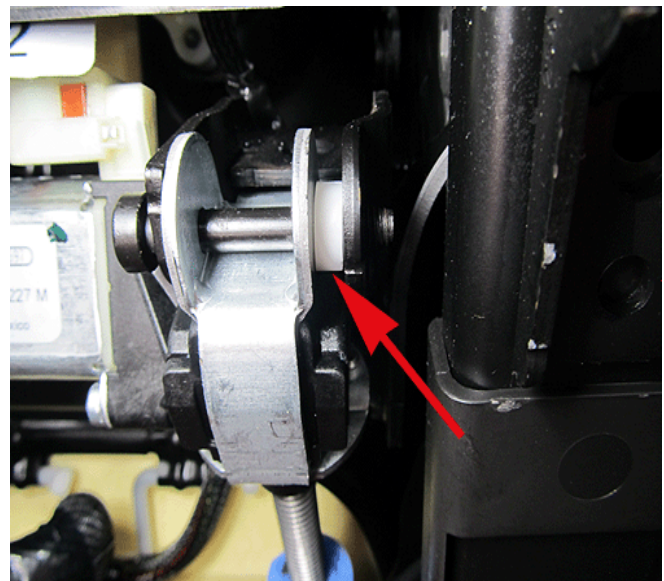

3619968

20. If a shim clip is not present, install the shim clip (1) as shown.

**Note:** It may be necessary to slightly spread the bracket on the seat frame with a large screwdriver to allow clearance for the clip.

## Parts Information

Causal Part	Description	Part Number	Qty
N/A	Front Seat Lateral Retainer	13405675	1 per seat
	Shim Clip	13594989	1 per seat
	GM Super Lube 3 oz. Tube	12371287 (In Canada, use 10953437)	As Required

## Warranty Information

For vehicles repaired under the Bumper-to-Bumper coverage (Canada Base Warranty coverage), use the following labor operation. Reference the Applicable Warranties section of Investigate Vehicle History (IVH) for coverage information.

Labor Operation	Description	Labor Time
7080188*	Lubricate Front Seat Pivot Points, Install Lateral Retainer and Install Seat Actuator Shim Clip.	0.6 hr
Add	Perform procedure to both front seats (If Needed)	0.4 hr

\* This is a unique Labor Operation for Bulletin use only.

Version	1
Modified	Released December 17, 2018

