



Tech Tips

TT 44-13-03

Date: November 8, 2013

2012-2014 Jetta/Sportwagen, Golf/GTI, Passat/CC, Tiguan,
Touareg, Routan Four Wheel Alignments

This Tech Tip provides an overview of vehicle four wheel alignment, and important steps that should be followed when performing four wheel alignments.



Note:

Email a scanned copy of the before and after alignment measurements to VWGoA.Chassis@vw.com, and file the printed copy with the Repair Order. If a Volkswagen Technical Assistance (VTA) ticket was opened, the alignment before and after measurements should be attached, before the VTA is closed. This is required for all alignment check or repairs performed under warranty.

Email must include the following information:

- VIN
- Repair Order (RO) Number
- Mileage (from RO)
- Dealer Code

The alignment data must be a legible scanned copy of the original print or screen capture (picture). The recommended formats are PDF or JPEG.



Service Information

Below are examples of acceptable attachments:

<div style="border: 1px solid black; width: 100px; height: 40px; display: inline-block;"></div>		Customer		<div style="border: 1px solid black; width: 100px; height: 20px; display: inline-block;"></div>	
		Vehicle ident no.		Repair order no.	
		Technician		Date	
		<div style="border: 1px solid black; width: 40px; height: 20px; display: inline-block;"></div>		<div style="border: 1px solid black; width: 40px; height: 20px; display: inline-block;"></div>	
License plate no.	First reg. date	Model	Odometer reading: km/miles		
		Volkswagen : Passat : 2012 : Standard Suspension (G02 G11)	8		
Complaints or reason for alignment check					
			Before	Target Data	After
Rear axle	Camber	left	-1°26'	-1°20' +/-0°30'	-1°14'
		right	-0°48' *		-1°15'
		cross	-0°38' *	0°00' +/-0°30'	0°00'
	Setback		0°00'		-0°07'
	Toe	left	0°09'	0°05' +/-0°05'	0°01'
		right	-0°06' *		0°07'
		total	0°03'	0°10' +/-0°10'	0°08'
	Geometrical driving axis		0°00'	+/-0°20'	-0°03'
	Axle Offset		0°00'	+/-0°20'	0°05'
	Front axle	Camber	left	-0°54'	-0°30' +/-0°30'
right			-0°17'		-0°25'
cross			-0°38' *	0°00' +/-0°30'	-0°17'
Caster		left	7°21' *	7°55' +/-0°30'	7°45'
		right	7°15' *		7°39'
		cross	0°06'	0°00' +/-0°30'	0°06'
SAI		left	13°08'		12°56'
		right	11°32'		11°41'
		cross	1°36'	0°00'	1°15'
Track differential angle		left	-1°38'	-1°33' +/-0°20'	-1°38'
		right	-1°20'		-1°20'
Toe		left	-0°05' *	0°05' +/-0°05'	0°04'
		right	0°10' *		0°04'
		total	0°05'	0°10' +/-0°10'	0°08'
Setback				0°00'	0°08'
Max steering lock	left steer	left	-38°48'		-38°48'
		right	31°54'		31°54'
	right steer	left	32°34'		32°34'
		right	-39°12'		-39°12'
Wheelbase Difference				-0°15'	
Track Width Difference				-0°50'	
Lateral Offset	left			-0°30'	
	right			-0°20'	

* This value is not within specification. Tire wear, handling and safety problems may result.

VwvAgn 11.1 9833 USA 2012.0.1 HB4010M



Das Auto.

Service Information

Work Order:
 Last Name:
 Company:
 VIN:
 License:
 Year:
 Technician:
 Mileage:
 Date



Volkswagen : Passat : 2012 : Standard Suspension (G02 G11)

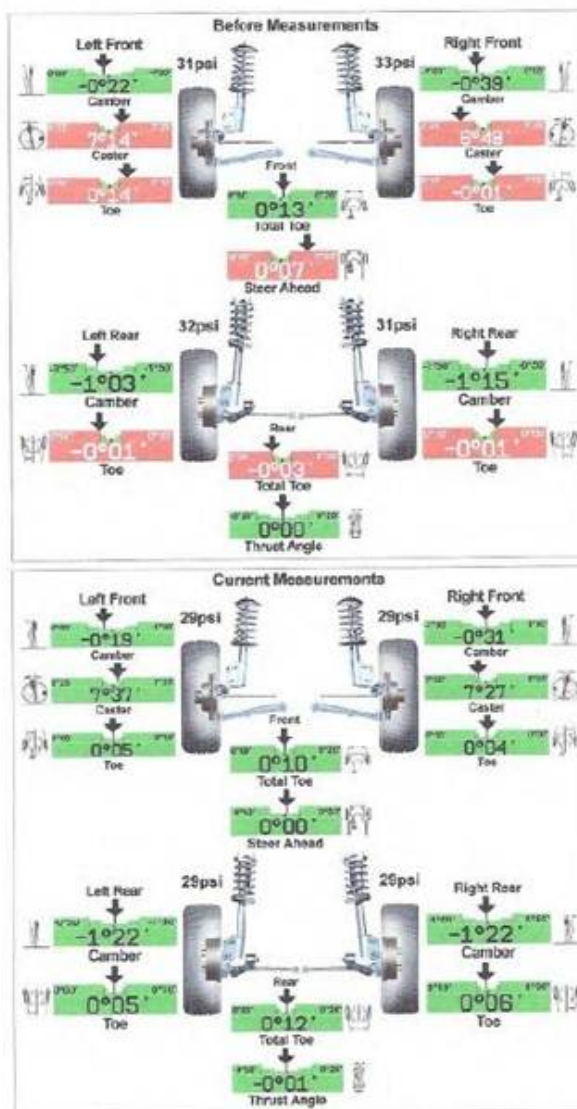

* One or more values are not within specification. Tire wear, handling and safety problems may result.

Service Information

Section 1. Alignment Overview

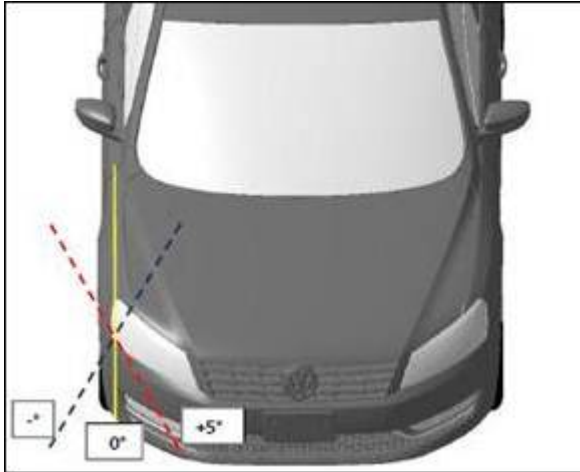

TOE - The amount the tires point inwards or outwards when viewing the car from above.

Figure 1

Positive toe (red line) or Toe-in: The tires point inwards towards the center of the vehicle.

Negative toe (blue line) or Toe-out: The tires point outwards away from the center of the vehicle

Figure 1

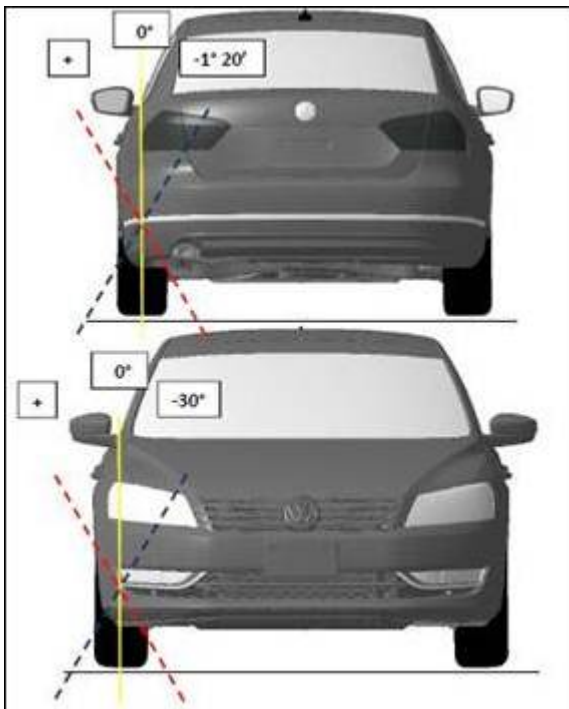

CAMBER - Angle between the vertical axis of the wheel and the vertical axis of the vehicle when viewed from the front or rear.

Positive (red line): The upper sidewall of the tire is tilted outwards away from the center of the vehicle.

Negative (blue line): The upper sidewall of the tire is tilted towards the center of the vehicle.

Figure 2

Service Information

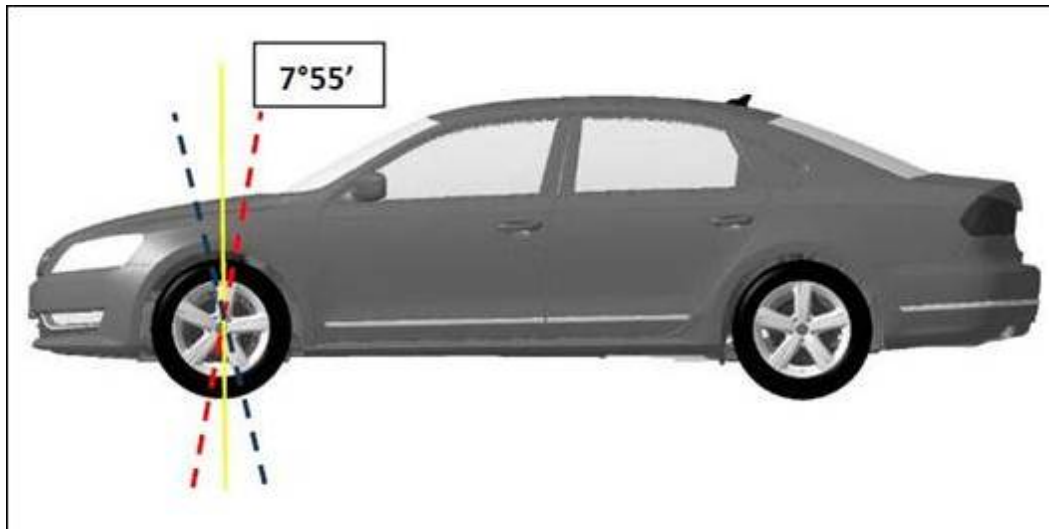

Figure 3

CASTER - When viewing a car from the side, the angle of the vehicle's steering axis is defined by drawing a line through the upper and lower ball joints (for a double wishbone front suspension), or through the strut tower mount and the lower ball joint.

Positive (red line): The line leans towards the rear of the car.

Negative (blue line): The line leans towards the front of the car.

 **Tip:**

For additional information on wheel alignment see Self Study Program (SSP) 860103 – Wheel Alignment – Basics.

Toe adjustment

Front and rear toe adjustment procedures are located in the repair manual under, Repair Manual > Chassis > Suspension, Wheel, Steering > 44 Wheels, Tires, Wheel Alignment > General Information.

 **Note:**

When performing wheel alignment, the steering column must be adjusted to the center tilt position. This is due to steering wheel off set of up to 1.2 degrees from center tilt position of the steering column to the full up or the full down tilt position.

Service Information

Camber adjustment

Camber adjustments should be made based on the information in the repair manual.



Note:

For all Volkswagen models **EXCEPT** Touareg, front camber is **NOT** an adjustable angle for normal four wheel alignment. The procedures in the repair manual to adjust camber are for body collision only (See note in repair manual). If the sub-frame bolts are loosened, tightened or removed for **ANY** reason, the bolts **MUST** be replaced with new bolts. Sub-frame bolts are torque to yield and should never be re-used after they are loosened.

Caster Measurement

Caster is not an adjustable angle for all models **EXCEPT** Touareg.

When performing alignment using the Hunter equipment, after the initial "Before" measurements is displayed, additional steps are required to read the correct caster measurement. Without these additional steps, the equipment may display caster measurements that are out of specification. Please follow the steps below to obtain the correct caster measurements.



Step 1

When the initial "Before" measurements are displayed, scroll down to make additional measurements.

Figure 4

Service Information



Figure 5

Step 2

Press K3 to select > Make Additional Measurement.

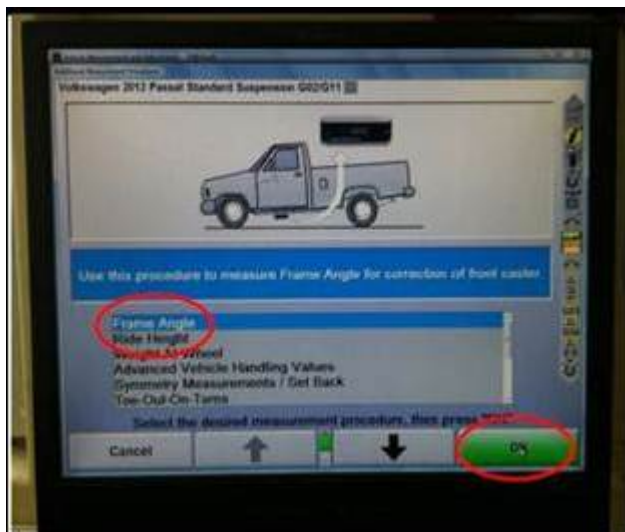

Figure 6

Step 3

Scroll down to select > Frame Angle > Press K4 to select OK.



Tip:

An electronic level (Inclinometer) can be used to measure vehicle frame angle. If a tool is not available, measure the vehicle ride height (Standing height), and if within specification per the repair manual, enter 0.4° for the left and right frame angle.

Service Information



Figure 7

Step 4

Measure the vehicle frame angle at the door sills using an electronic level (Inclinometer).

Tip:

The frame angle for the car in figure 7 measures 0.9° , where the rear is higher than the front. The nominal frame angle is 0.4° by design and must be subtracted from the measured frame angles.

For example $0.9^\circ - 0.4^\circ = 0.5^\circ$

If an electronic level (inclinometer) is not available, measure the vehicle standing height (ride height), and if within specification per repair manual, enter 0.4° for the left and right frame angle

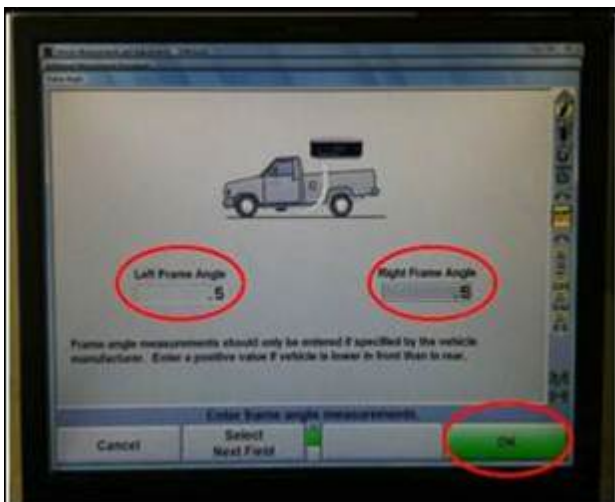

Figure 8

Step 5

Enter the angles in the left and right frame angle fields > press K4 to select OK.

The caster measurement will now read correct. Please note that cross caster measurement will remain the same.

Measuring Vehicle Standing Height and Axle Symmetry (Set Back)

Vehicle ride height and symmetry measurement (Set back) are very important when diagnosing vehicle suspension or drifting/pulling concerns. To make these measurement and have them display in the alignment summary, select K3 > Make Additional Measurement and scroll down to select these measurements.

Service Information

Standing Height

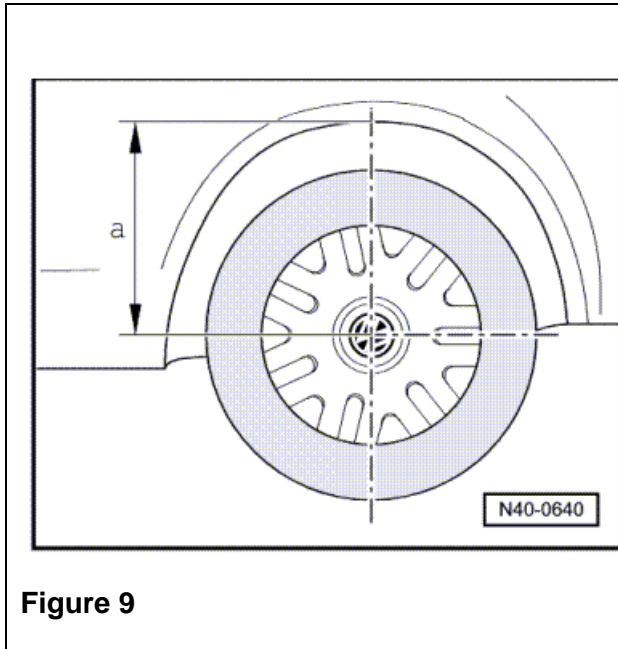

Measure standing height “a” as shown in figure 9 and enter the values in the alignment tool to have the values displayed in the alignment summary.

Tip:
If the alignment equipment body target accessories are available the vehicle standing height can be automatically captured by the alignment equipment. Please see the equipment manual for details of operation.

Axle Symmetry (Set Back)



Step 1
After selecting “Make Additional Measurements”, scroll down and select > Symmetry Measurements/Set Back > Press K4 for OK.

Service Information

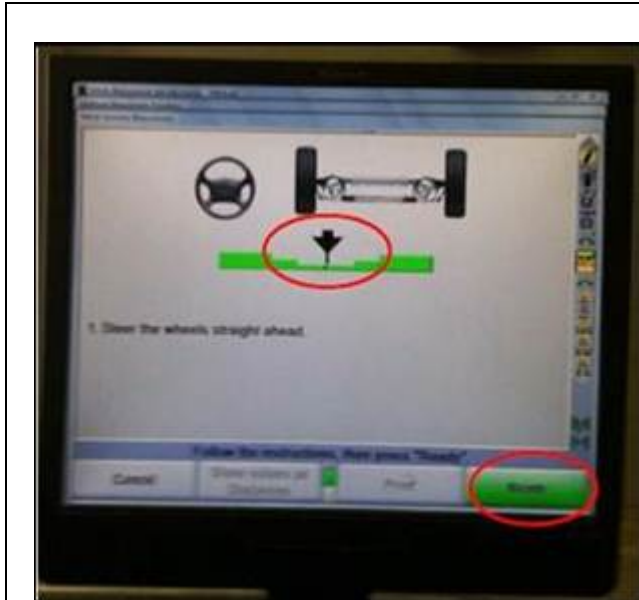

Figure 11

Step 2

Center the front wheels as shown on the monitor. > Press K4 for Ready.

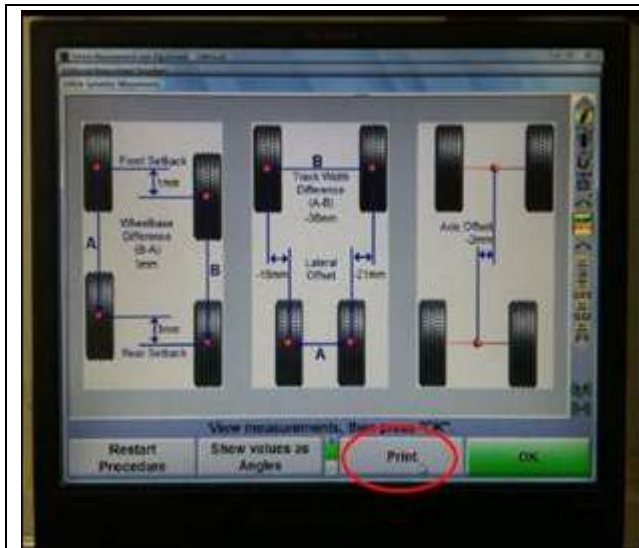

Figure 12

Step 3

The axle symmetry/ set back will be displayed in angles. To show angles as Distances > Press K2.

Enter the Rim Width.

Use tire balancer rim width caliper (example shown in figure 13) to measure rim width.



Figure 13

Service Information

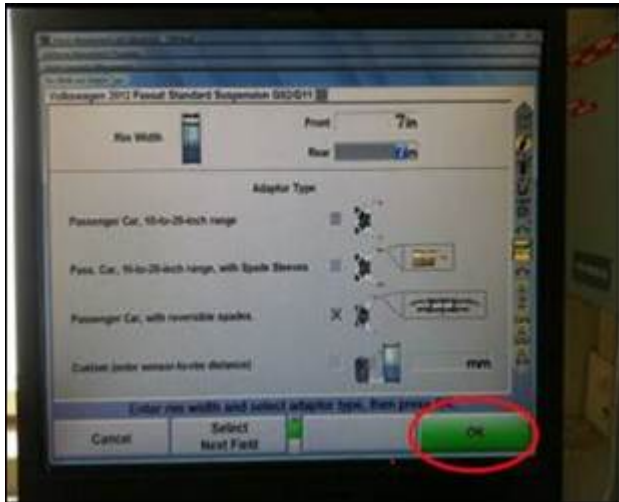

Figure 14

Step 4

Ensure that the correct box is checked depending on the type of wheel clamp spade that is used > Press K4 for OK.

Step 5

Steer the wheels straight ahead as instructed > Press K4 for Ready.

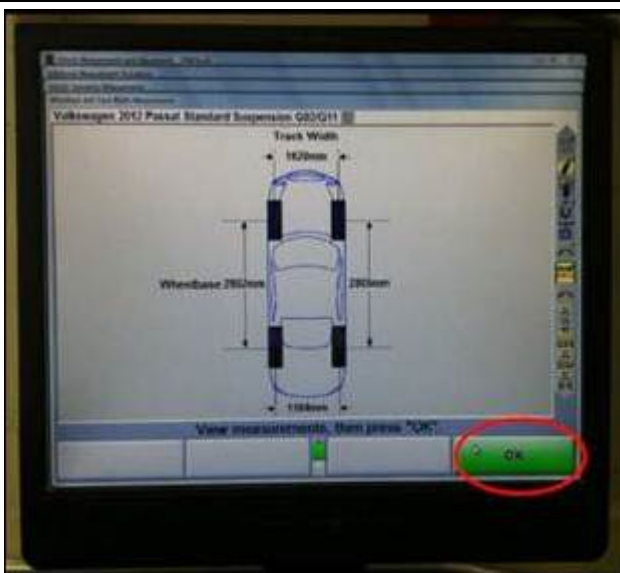

Figure 15

Step 6

Track and wheelbase screen is displayed > Press K4 for OK.

Service Information



Figure 16

Step 7

The axle symmetry measurement (set back) will now display in distances. Press K3 to print the alignment summary page.