



Technical Journal

TITLE:

Rear floor mats, fixation

REF NO: TJ 32979.1.0	ISSUING DEPARTMENT: Technical Service	CAR MARKET: United States and Canada	
PARTNER: 3 US 7510 Volvo Car USA		ISSUE DATE: 2017-10-30	STATUS DATE: 2017-11-15
FUNC GROUP: 8552	FUNC DESC: Floor upholstery (firewall upholstery: n	Page 1 of 15	

“Right first time in Time”

Attachment

File Name	File Size
TJ 32979 (Rubber mats).pdf	0.9293 MB
TJ 32979 (Textile mats).pdf	1.1024 MB

Vehicle Type

Type	Eng	Eng Desc	Sales	Body	Gear	Steer	Model Year	Plant	Chassis range	Struc Week Range
246							2018-2018		0000390-0026787	201717-201740

CSC Customer Symptom Codes

Code	Description
M7	Floor mats and carpets/Loose, poor fit, warped, wrinkled

VST Operation Number

VST Operation Number	Description
98682-2	Floor mat rear 2 pcs adjust acc. to TJ32979

DTC Diagnostic Trouble Codes

Text

**DESCRIPTION:**

If customer complains on rear floor mats may come out of position, please follow instruction under "Service".

The problem occurs on textile mats. If customer also have plastic mats without fixation holes, modification of those is also needed for correct fit.

SERVICE:

Use service kit for the carpets:

Kit for 2 rear Charcoal mats: 32216707

Follow instruction in attachment:

Textile mats: "TJ 32979 (Textile mats)

Plastic mats: "TJ 32979 (Rubber mats)

VEHICLE REPORT:

Yes, please submit a Vehicle Report if the service solution described in this TJ has no effect. Use concern area "Vehicle Report" and sub concern area "Support not needed", use function group 8552.

To view TJ attachments continue to next page. This TJ has two attachments.



Volvo Car Customer Service

TJ 32979 (Rubber mats)

Title	Rear floor carpet	Page	1 (6)
Action	Product fix	Operation number:	98682-2

Issue	Date	Reason
1	2017-10	First issue

Affected vehicles

Model year	Model
2018	XC60 (18-)

Materials

Materials	Qty.	Part No.	Notes
Butyl tape	0.01	1161783	
Service kit	1.0	32216707	Charcoal;

Special tools

Description	Part No.
Knife	981 4116

Adjustment

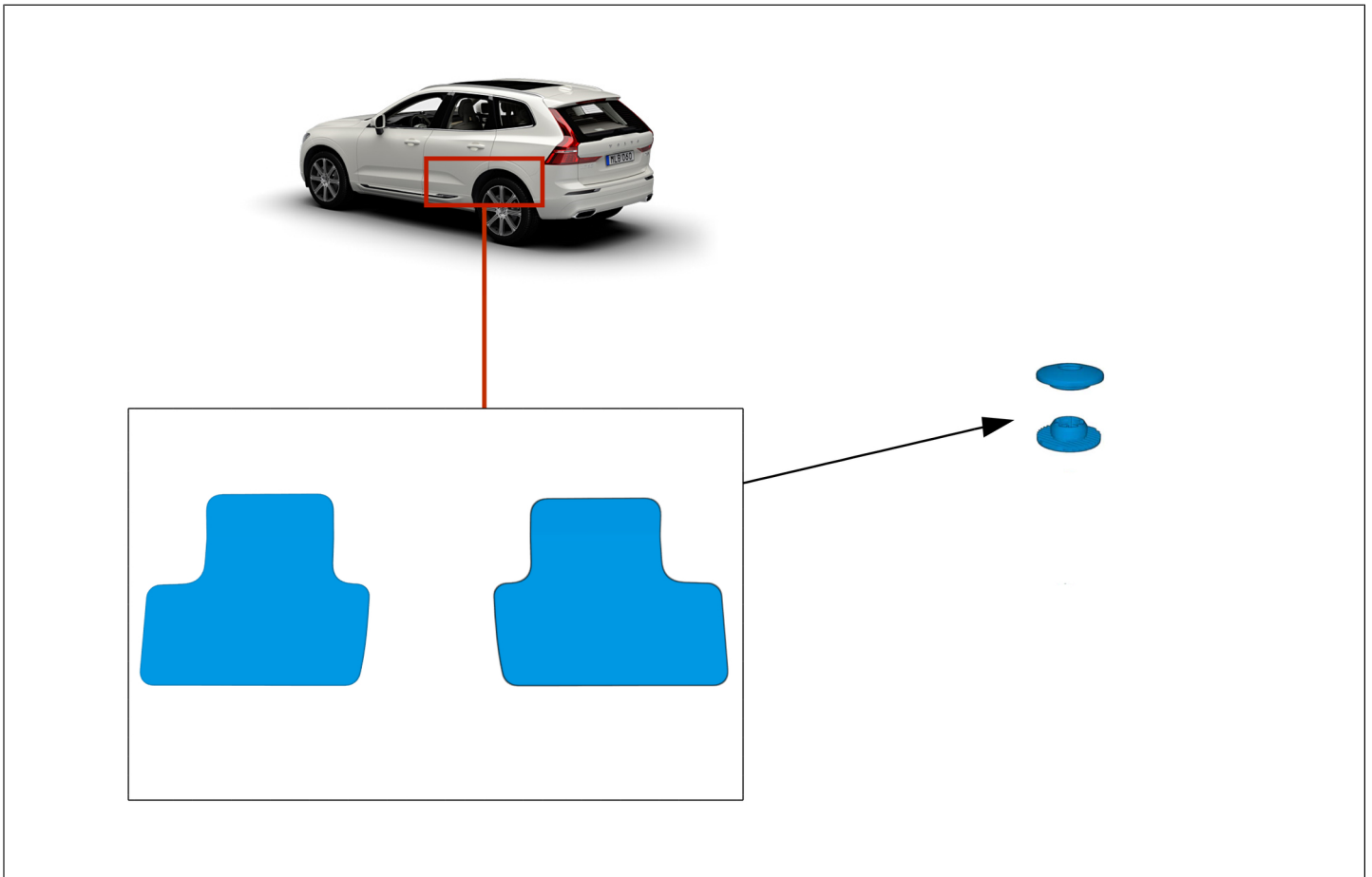

Color symbols

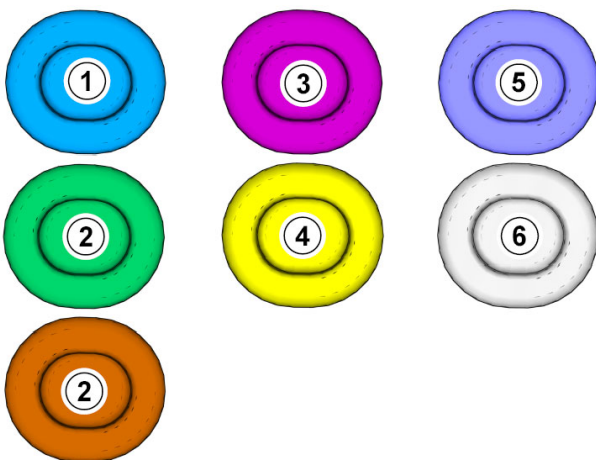

Note! This colour chart displays (in colour print and electronic version) the importance of the different colours used in the images of the method steps.

- 1 . Used for focused component, the component with which you will do something.
- 2 . Used as extra colors when you need to show or differentiate additional parts.
- 3 . Used for attachments that are to be removed/installed. May be screws, clips, connectors, etc.
- 4 . Used when the component is not fully removed from the vehicle but only hung to the side.
- 5 . Used for standard tools and special tools.
- 6 . Used as background color for vehicle components.

Applies to the right-hand side

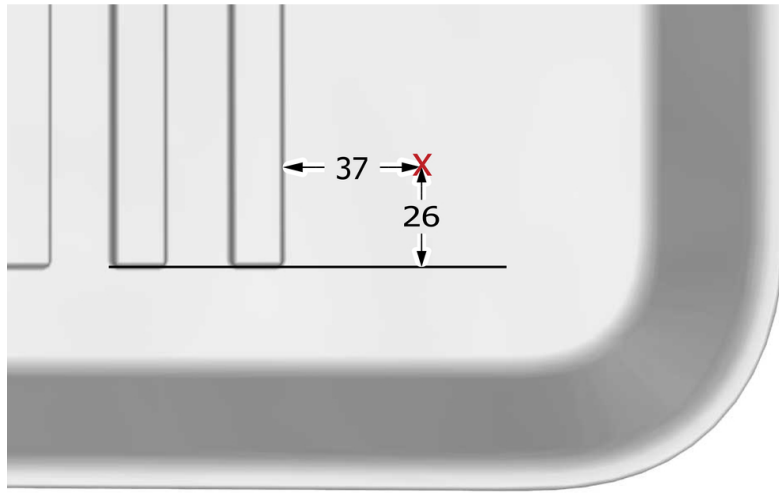

Right-hand side
Mark using a pen
Measure and mark as illustrated.



Left-hand side
Mark using a pen
Measure and mark as illustrated.

Applies to the left-hand side:

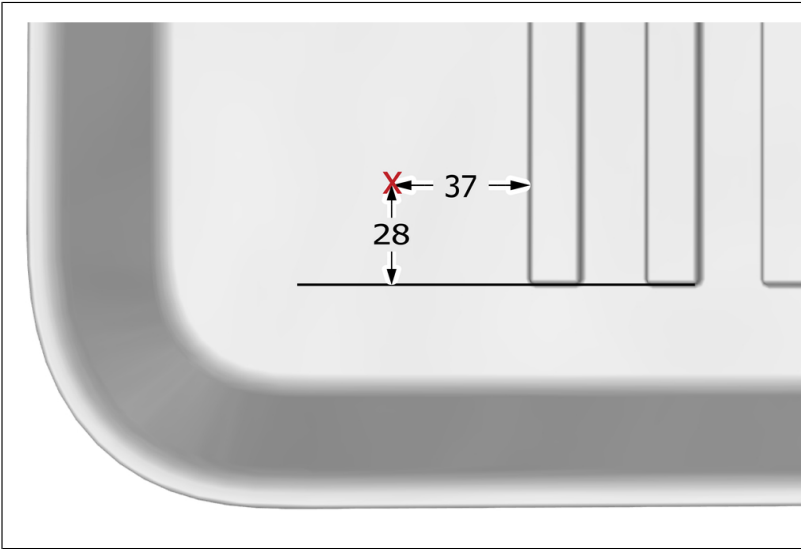

Left-hand side
Mark using a pen
Measure and mark as illustrated.

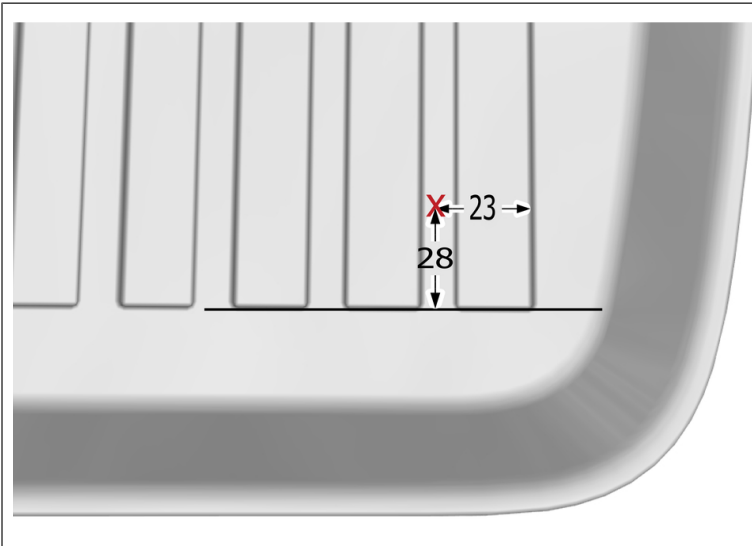

Right-hand side
Mark using a pen
Measure and mark as illustrated.

On both sides.

Check the value.

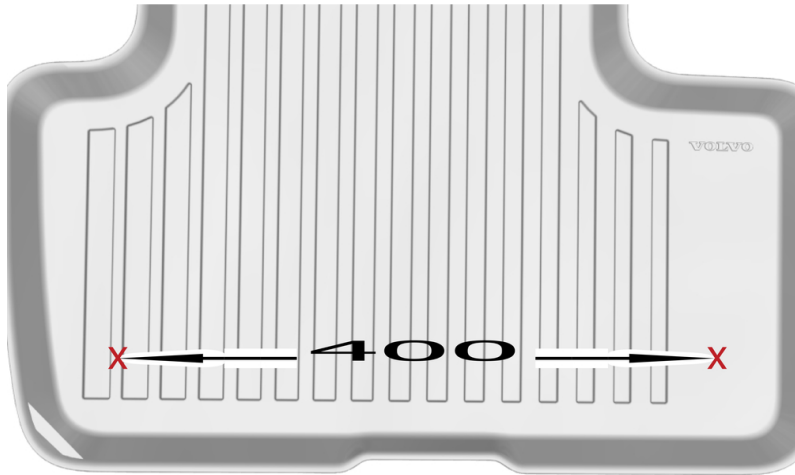

Drill the holes.

Special Tool: T9814116, Cylindrical knife

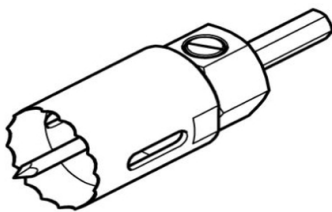

Note! Only use the specified material.

Use: Butyl tape , 1161783

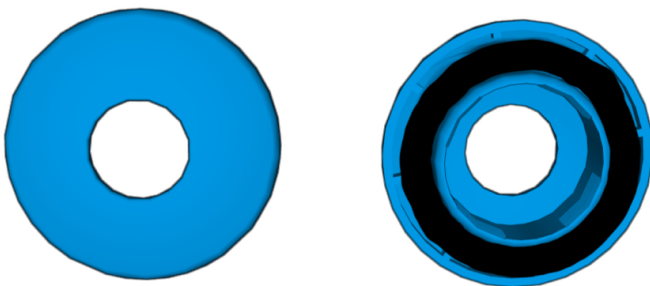

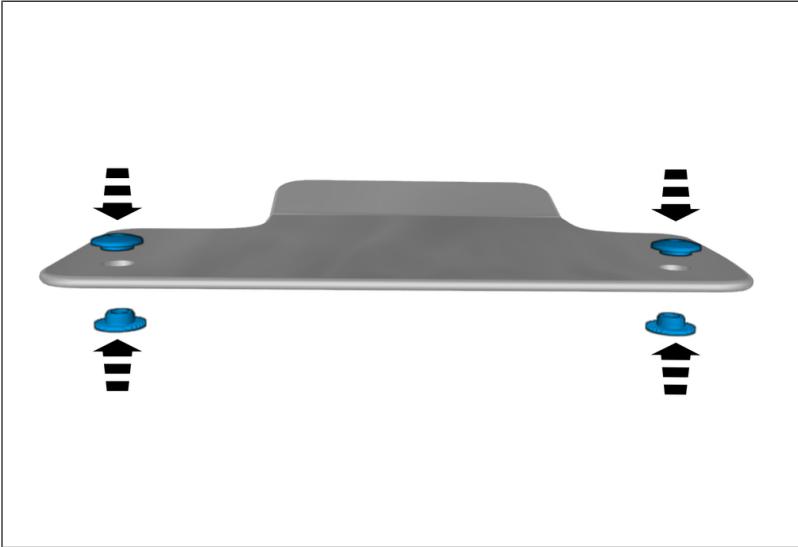

Note! Make sure that the component is centred.

Install the marked component.

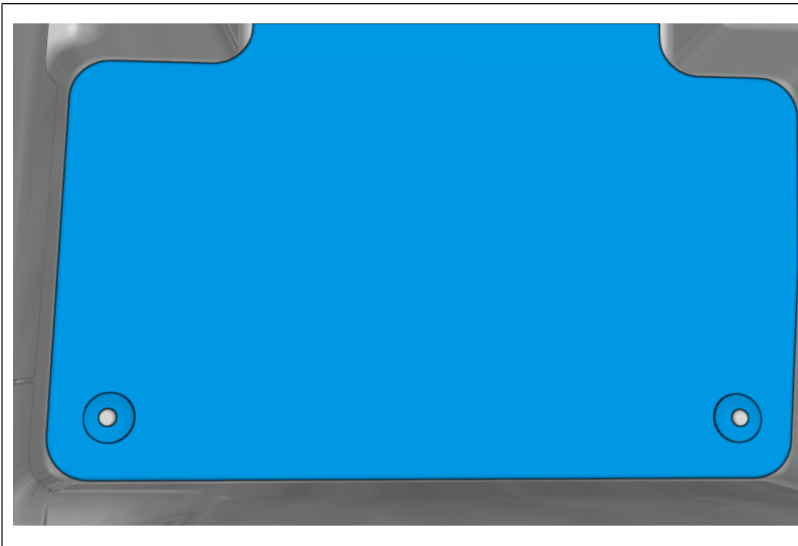

Install the marked component.



Volvo Car Customer Service

TJ 32979 (Textile mats)

Title	Rear floor carpet	Page	1 (7)
Action	Product fix	Operation number:	98682-2

Issue	Date	Reason
1	2017-10	First issue

Affected vehicles

Model year	Model
2018	XC60 (18-)

Materials

Materials	Qty.	Part No.	Notes
Service kit	1.0	32216707	Charcoal;

Special tools

Description	Part No.
Hole punch	999 7392

Equipment

Designation	Part No.
Awl/punch	

Adjustment

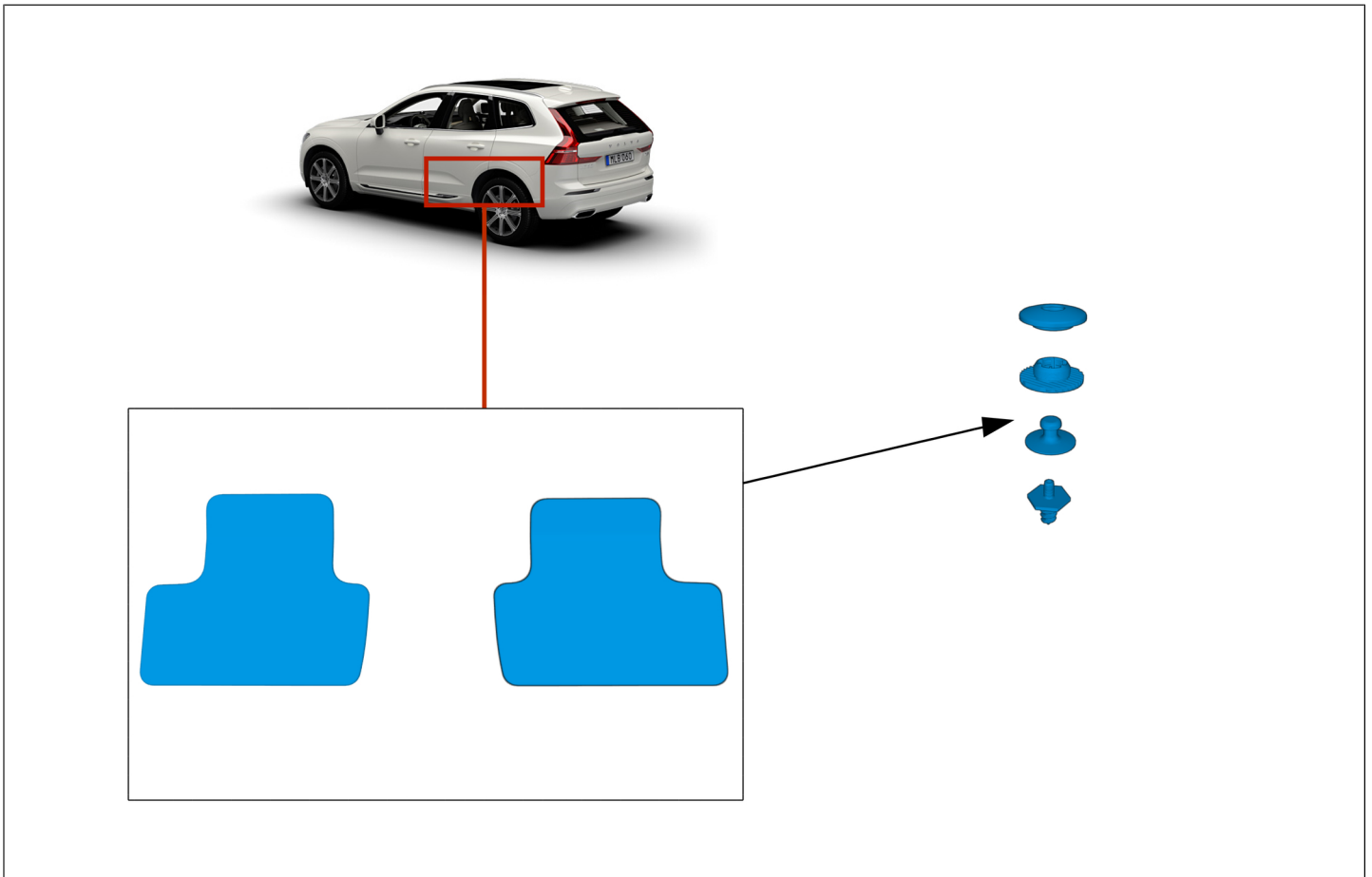

Color symbols

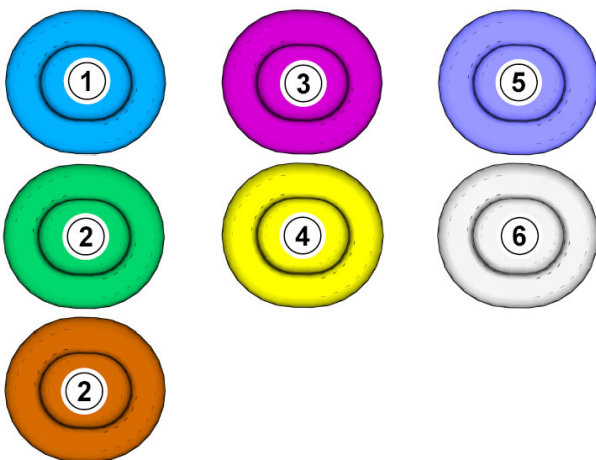

Note! This colour chart displays (in colour print and electronic version) the importance of the different colours used in the images of the method steps.

- 1 . Used for focused component, the component with which you will do something.
- 2 . Used as extra colors when you need to show or differentiate additional parts.
- 3 . Used for attachments that are to be removed/installed. May be screws, clips, connectors, etc.
- 4 . Used when the component is not fully removed from the vehicle but only hung to the side.
- 5 . Used for standard tools and special tools.
- 6 . Used as background color for vehicle components.

Applies to the right-hand side

Use appropriate tape to mark the position.

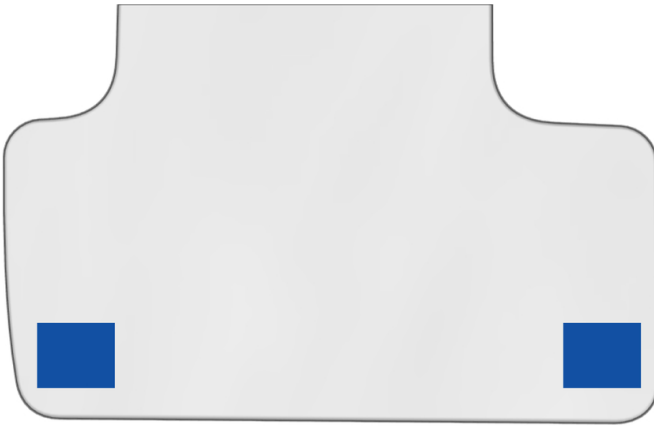

Right-hand side
Mark using a pen
Measure and mark as illustrated.

Use: Awl

Make a hole, using the tool indicated.
Use a 10 mm wide file

Use: Round file

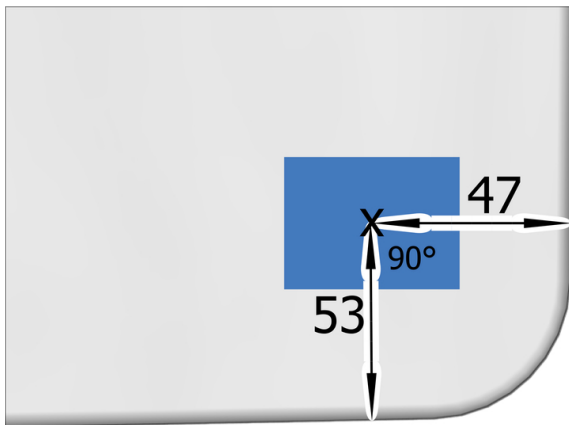

Left-hand side
Mark using a pen
Measure and mark as illustrated.
Make a hole, using the tool indicated.

Use: Awl

Use a 10 mm wide file

Use: Round file

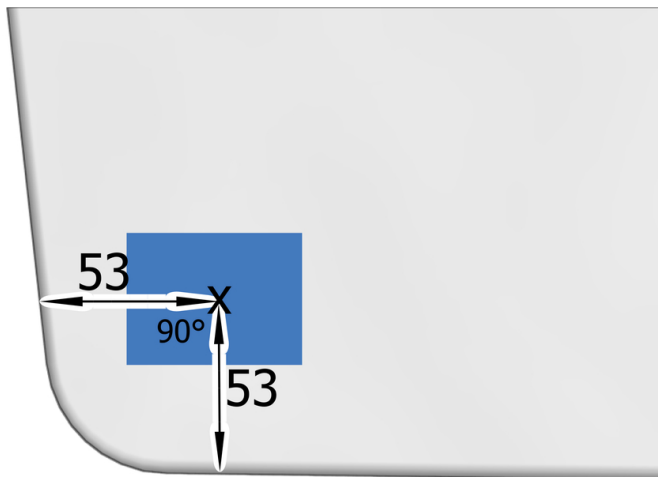

Applies to the left-hand side:

Use appropriate tape to mark the position.

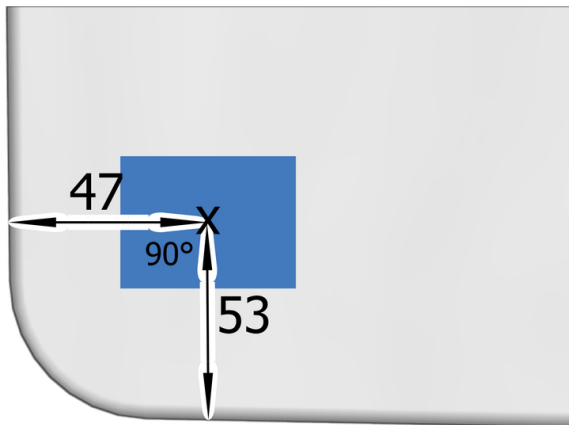

Left-hand side
 Mark using a pen
 Measure and mark as illustrated.
 Make a hole, using the tool indicated.

Use: Awl

Use a 10 mm wide file

Use: Round file

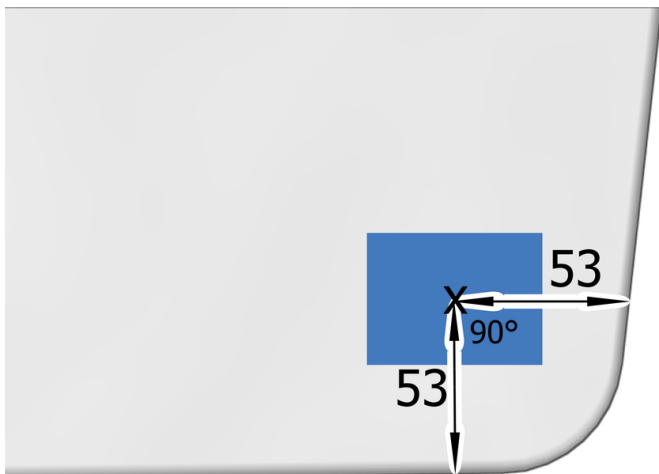

Right-hand side
 Mark using a pen
 Measure and mark as illustrated.
 Make a hole, using the tool indicated.

Use: Awl

Use a 10 mm wide file

Use: Round file

On both sides.

Check the value.



Note! Make sure that the component is centred.

Special Tool: T9997392, Hole punch

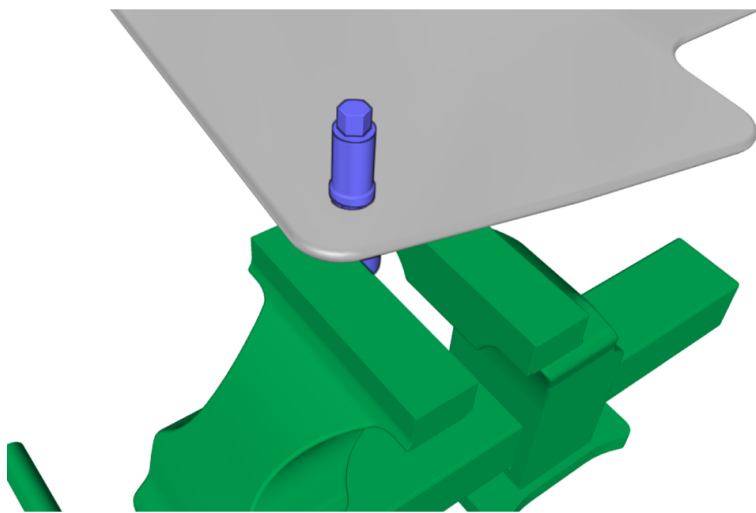

Note! Make sure that the component is centred.

Install the marked component.

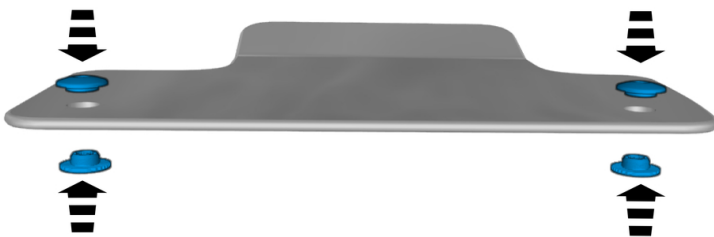



Caution! Make sure that the component is positioned correctly.

Install the marked component.

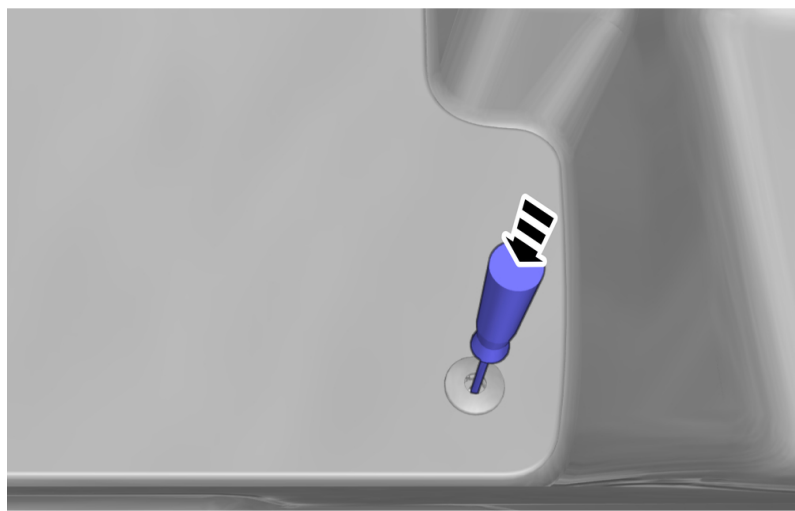

Mark the centre.

Use: Awl



Remove the marked part.

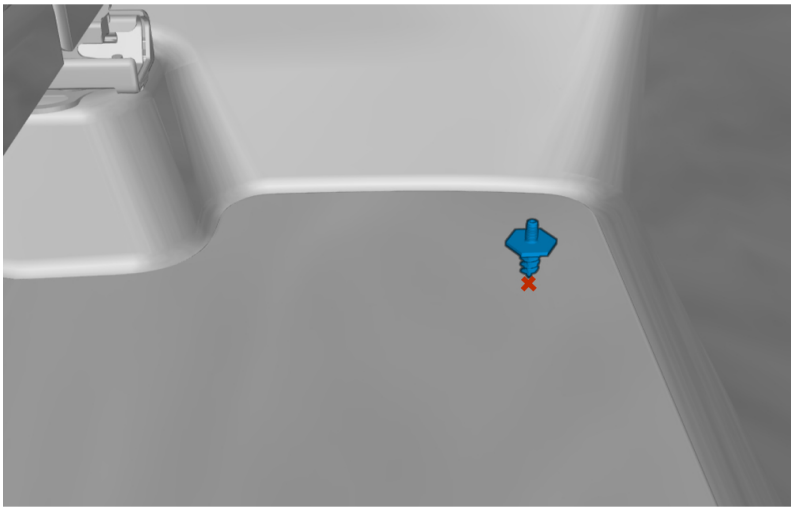

Install the screw.
On both sides.



Install the marked components.



Install the marked component.