



GROUP Product Improvement	MODEL See Model List on Page 1
NUMBER PI1803W/X (Rev 4, 04/10/2019)	DATE November 2018

PRODUCT IMPROVEMENT CAMPAIGN

SUBJECT: ENGINE REPLACEMENT INSTRUCTIONS
FOR DTC P1326 (PI1803W/X)

★ NOTICE

This bulletin has been revised to include additional information. New/revised sections of this bulletin are indicated by a black bar in the margin area.

This bulletin provides information related to the Technical Service Bulletin previously published in November 2018 ([PI1803](#), Rev 1, 01/02/2018) titled “Knock Sensor Detection System - ECU Logic Improvement”. Specifically, this bulletin provides instructions on which procedures to follow if, after installation of the KSDS, any one of the subject vehicles below returns to the dealer with Diagnostic Trouble Code (“DTC”), P1326.

Year	Model	Engine	Production Date
2011-2013	Optima (QF/TF)	2.4L & 2.0L T-GDI	8/12/10 – 9/27/13
2014	Optima (QF)	2.4L & 2.0L T-GDI	8/28/13 – 5/15/14
2011-2013	Sportage (SL)	2.0L T-GDI	12/30/10 – 8/30/13
2012-2014	Sorento (XMa)	2.4L GDI	4/19/11 – 2/10/14

If DTC P1326 is present, first check for any wiring signal interference following the procedure set forth below before determining whether an engine replacement is necessary. Based on the results of the Wiring Signal Interference Check, dealers are to perform either the Knock Sensor Wiring Repair or, if the engine noise inspection result confirms it, the Engine Long-Block Replacement, according to the procedures in this TSB.

If the vehicle’s engine is already seized or severely knocking, dealers are to perform the Engine Long-Block Replacement **and** the Wiring Signal Interference Check according to the procedures in this TSB.

A [Vehicle Diagnosis Number \(VDN\)](#) must be created with DTC P1326, prior to performing PI1803W/X. If a VDN is not created, Warranty claim submission issues may occur.

Before conducting the procedure, verify the vehicle is included in the list of affected VINs.

★ NOTICE

To ensure complete customer satisfaction, always remember to refer to WebDCS Warranty Coverage (validation) Inquiry Screen (Service → Warranty Coverage → Warranty Coverage Inquiry) for a list of any additional campaigns that may need to be performed on the vehicle before returning it to the customer.

File Under: <Product Improvement>

Circulate To: General Manager Service Manager Parts Manager
 Service Advisors Technicians Body Shop Manager Fleet Repair

Flow Chart:

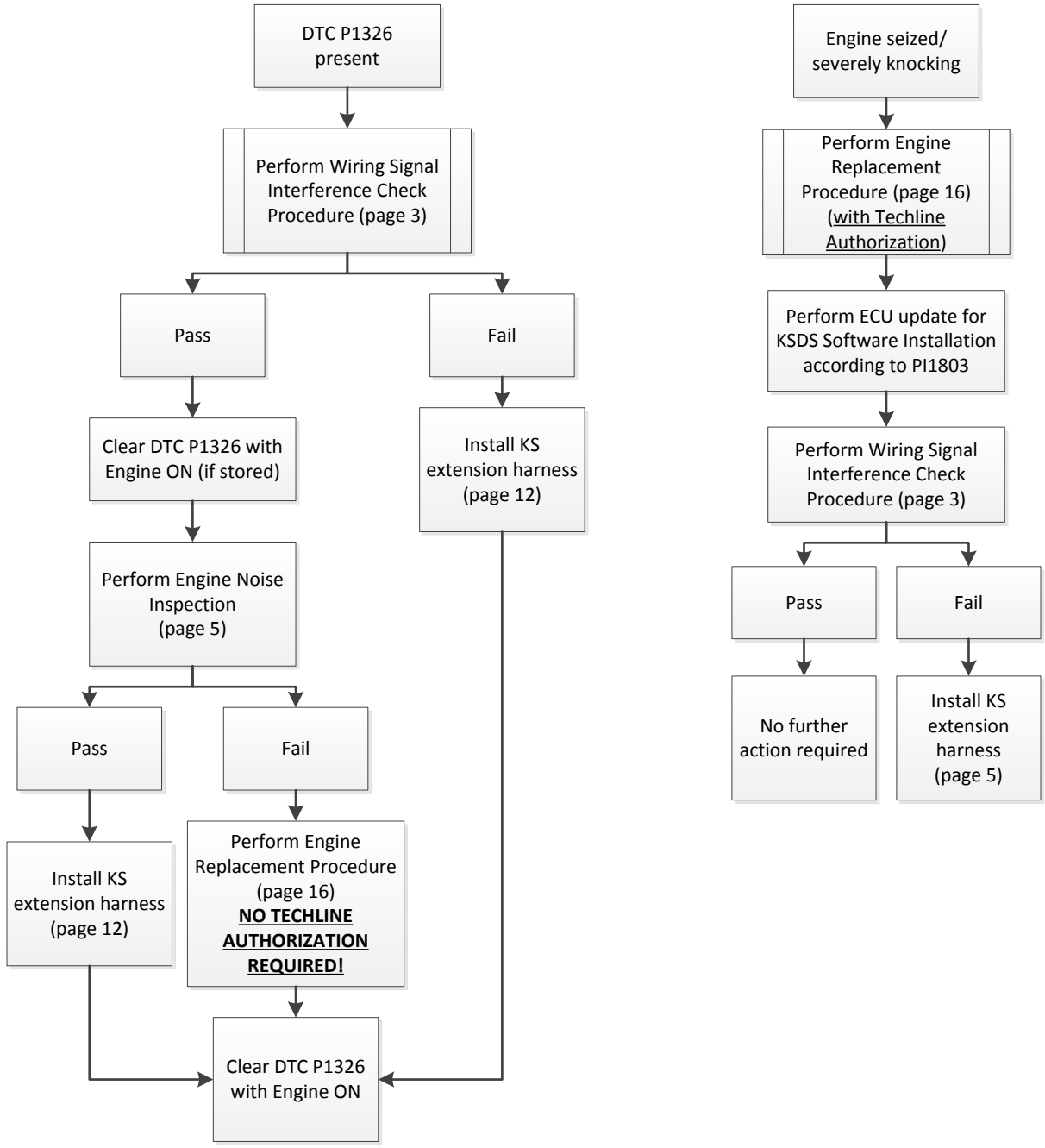

Note: If any concerns arise after completing the flow chart, open a Techline case online.

*** IMPORTANT**

ALL claims for engine or harness replacement without the required diagnostic inspection/results or authorization are subject to claim chargeback/denial without exception.

SUBJECT: ENGINE REPLACEMENT INSTRUCTIONS FOR DTC P1326 (P11803W/X)
Wiring Signal Interference Check Procedure:

- Using the KDS (connected to the internet), perform a Fault Code Search and confirm DTC P1326 is present.
 - If P1326 is present, proceed to the next step to perform the wiring signal interference check.
 - If the engine is seized or severely knocking**, proceed to the engine replacement procedure on page 16 (with Techline authorization per Flow Chart).

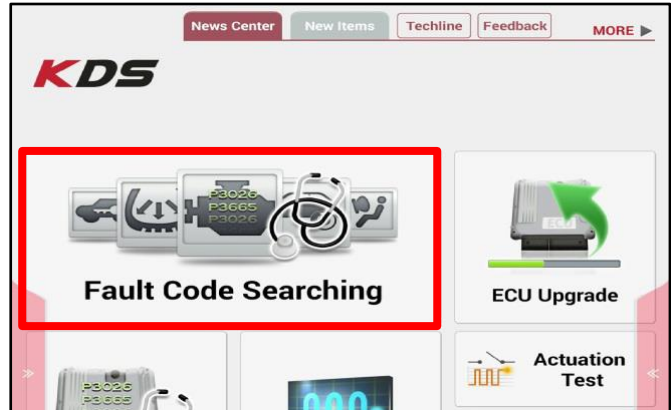

- Start/warm up the engine and ensure **ENGINE OIL** is at operating temperature (176°F).

The screenshot shows the 'Data Analysis' screen with a table of sensor data. The table has columns for 'Sensor Name(167)', 'Value', 'Unit', and 'Link Up'. The 'Engine Oil Temperature' row is highlighted with a red box.

Sensor Name(167)	Value	Unit	Link Up
Battery Voltage	13.3	V	
Battery Voltage after IG Key	13.3	V	
Actual Engine Speed	653	RPM	
Engine Oil Temperature	176.0	'F	

- From the KDS Home Screen, select S/W Management.

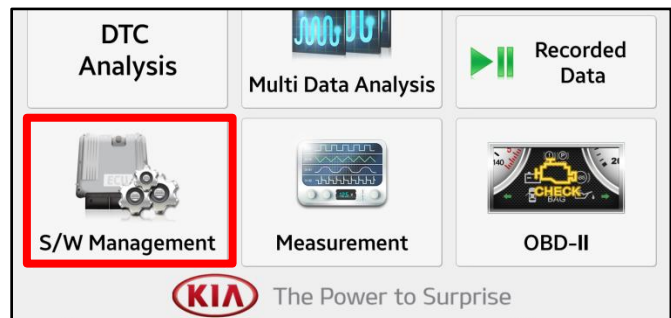

- Select Engine Control → Wiring Signal Interference Check.

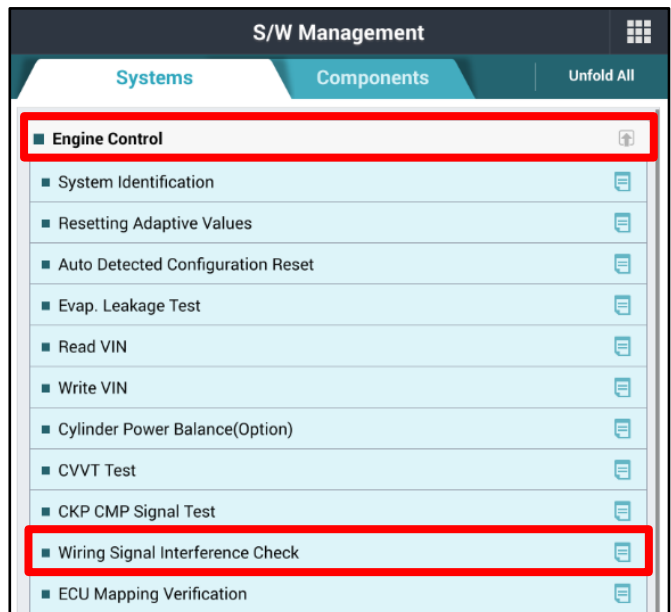

SUBJECT: ENGINE REPLACEMENT INSTRUCTIONS FOR DTC P1326 (P11803W/X)

- 5. Ensure the engine is on and at idle and **ENGINE OIL** temperature is at 176°F degrees or higher. Select OK to proceed.

• Wiring Signal Interference Check	
Purpose	This function is to check wiring signal interference by measuring knock sensor values.
Enable Condition	1. Engine On 2. Engine oil temp must be higher than 176°F (80°C) 3. Do not push accelerator pedal
Concerned Component	-
Concerned DTC	-
Fail Safe	-
Etc	

OK

- 5b. Select OK to proceed.

NOTE: This test should only be performed if Knock Sensor Detection System - ECU Logic Improvement (P11803) has previously been completed.

• [Wiring Signal Interference Check]

This function is to check wiring signal interference by measuring knock sensor values.

• [Test Requirements]

1. Engine Status : Idle
2. Engine oil temp must be higher than 176°F (80°C)
3. Do not depress accelerator pedal

⚠ [Warning]
Run the test after completing ECU upgrade.

[OK] button : Go to next
[Cancel] button : Go to main Screen

OK Cancel

- 5c. If the conditions are not met, a pop-up as shown will be displayed.

Information

The requirement below is not met!

[Do not depress accelerator pedal]

Press [OK] button and try again.

OK

- 6. Enter vehicle mileage and RO number (VIN is automatically populated).

• [Wiring Signal Interference Check]

Enter mileage and RO.

[OK] button : Go to next
[Cancel] button : Go to main screen

VIN : 5XX (17 digits)

Mileage : mile (up to 999,999)

RO : (up to 12 digits)

OK Cancel

SUBJECT: ENGINE REPLACEMENT INSTRUCTIONS FOR DTC P1326 (P11803W/X)

7. Wiring Signal Interference Check test will begin and take about three (3) minutes to complete. **NOTE:** Do not push on the accelerator pedal.

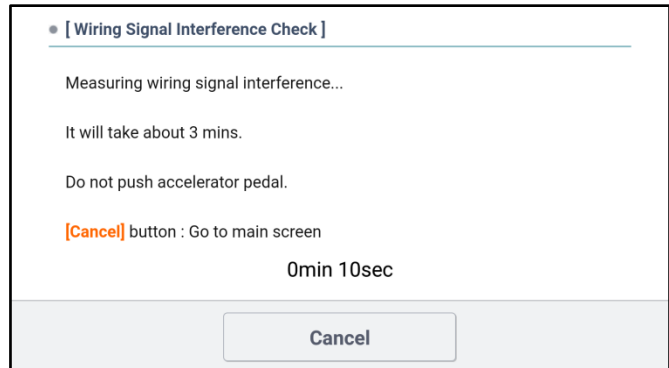

- If the result is "OK", **clear DTC P1326** and then proceed to the Engine Noise Inspection procedure below.

*** NOTICE**

DTC P1326 must be cleared in order to perform the Engine Noise Inspection Procedure.

- If the result is "NOT OK", turn the engine off and proceed to **step 2** of the Knock Sensor (KS) Extension Harness Installation procedure on page 12.

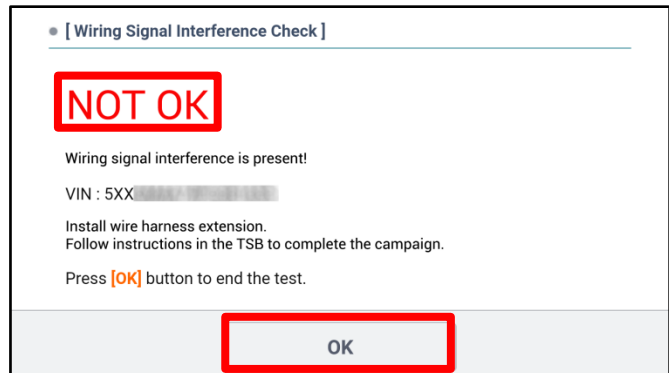
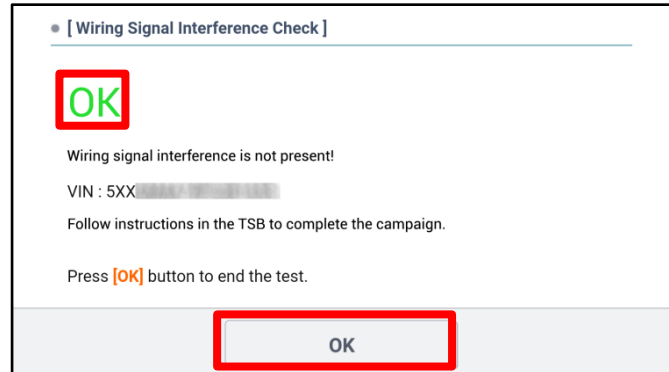

Engine Noise Inspection Procedure:

- Prior to inspection, ensure the KDS is fully charged and is connected to the internet every day to ensure the latest update is received and installed.
 - Engine oil level should be at the "FULL" mark. Top off with 5W-30 if required.
 - Test requires the engine to be in satisfactory running condition and able to idle normally.
 - Engine coolant temperature should be above minimum test temperature: 185°F (85°C).

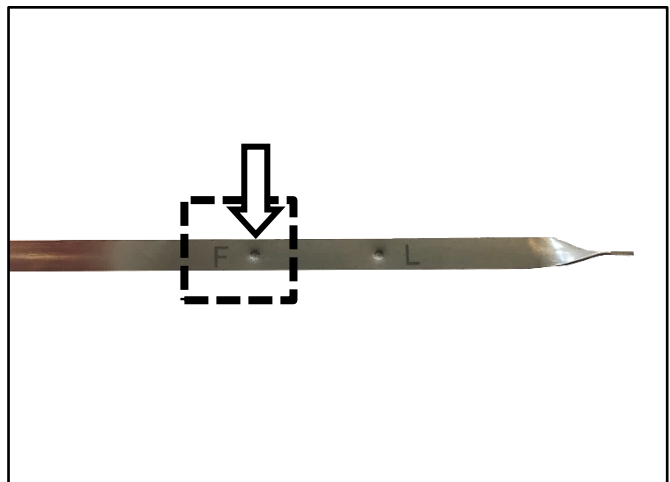

If the engine's running condition is poor due to issues unrelated to a connecting rod knocking noise (faulty sensors, intake/exhaust manifold leak, catalytic converter, etc.), diagnose and repair prior to performing this inspection procedure. If the engine cannot be tested or has other major concerns, **see Warranty Claim Authorization information on page 30.**

2. With the engine off, remove the dipstick (A).

*** NOTICE**

Engine cover removed in images for demonstration-only purposes.

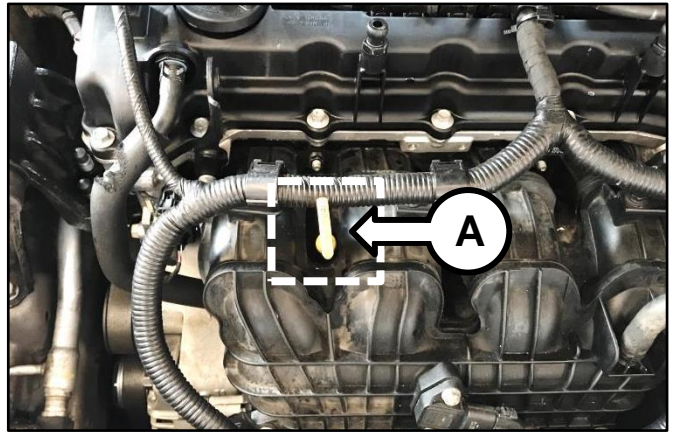

3. Insert the engine noise tester SST adapter (B) into the dipstick tube then start and idle the engine.

*** NOTICE**

To avoid false readings, ensure the adapter (B) is properly inserted into the dipstick tube and that the tube is not in contact with the intake manifold.

If the dipstick tube is not centered and is close to or touching the manifold, carefully adjust (bend) and center the dipstick tube with a pry bar.



Not Centered Centered

[Click here for a video tutorial of the Inspection Procedure.](#)

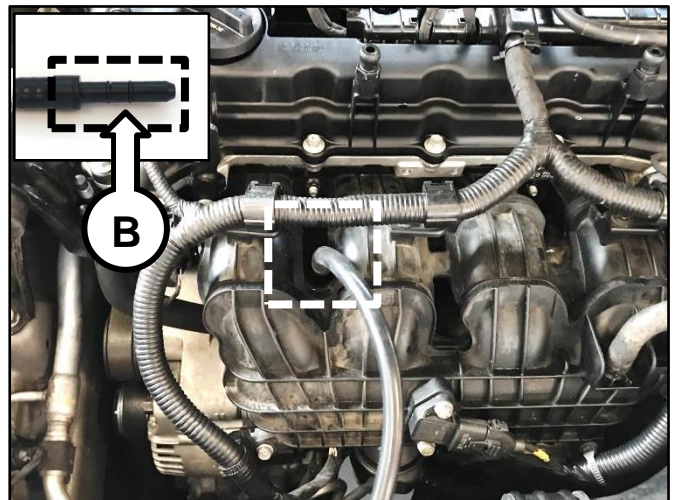
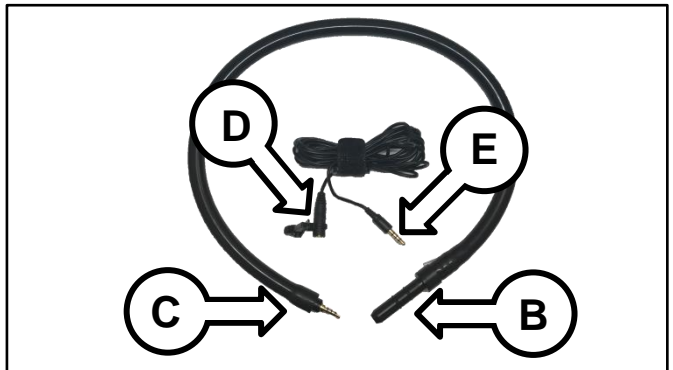

4. Connect the 3.5 mm male end of the engine noise tester SST (C) to the 3.5 mm female end of the extension cable (D).

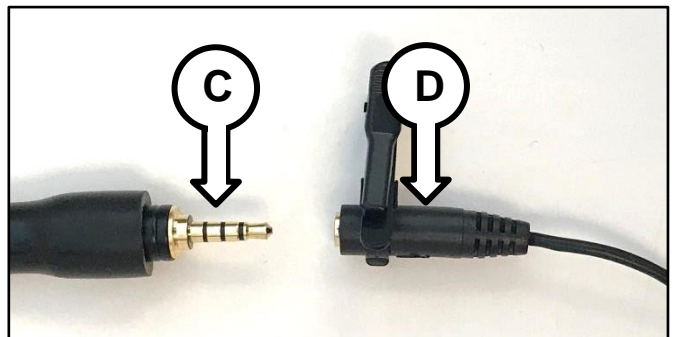

SUBJECT: ENGINE REPLACEMENT INSTRUCTIONS FOR DTC P1326 (P11803W/X)

5. Attach the SST clip of the extension cable (D) to the hood latch.

*** NOTICE**

Make sure to route the extension cable away from moving parts (pulleys, fan, and belts and be careful not to get it pinched between door and body or window, etc.).

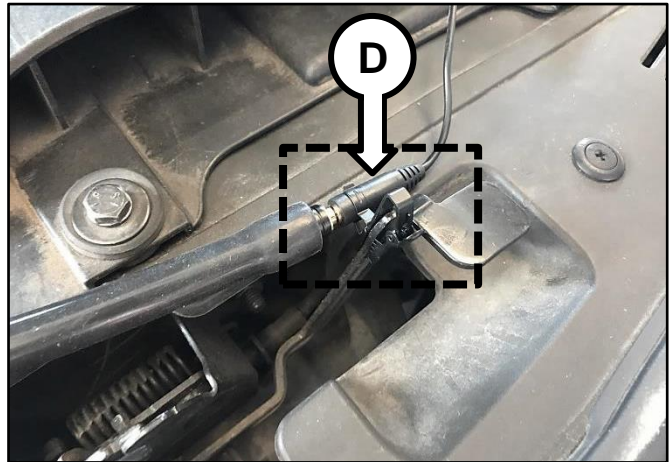

6. Connect the 3.5 mm male end (E) of the extension cable to the headphone port located at the upper left corner (KDS version 1.0) or at the bottom of the tablet (KDS version 2.0).

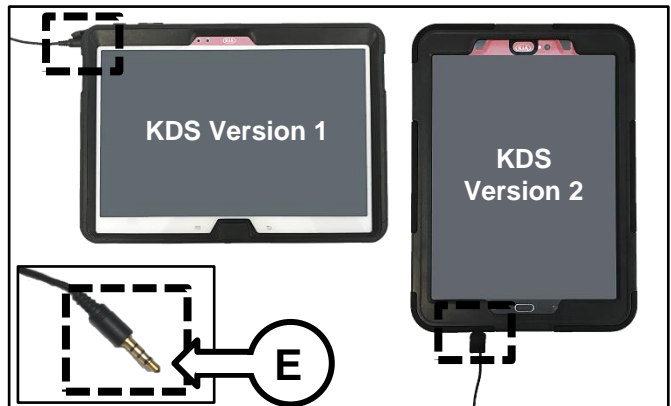

7. Connect the VCI-II to the OBD-II connector and launch the KDS application from the KDS tablet home page.



8. Confirm communication with VCI (F) and then configure the vehicle (G) using the **AUTO VIN** (H) feature.

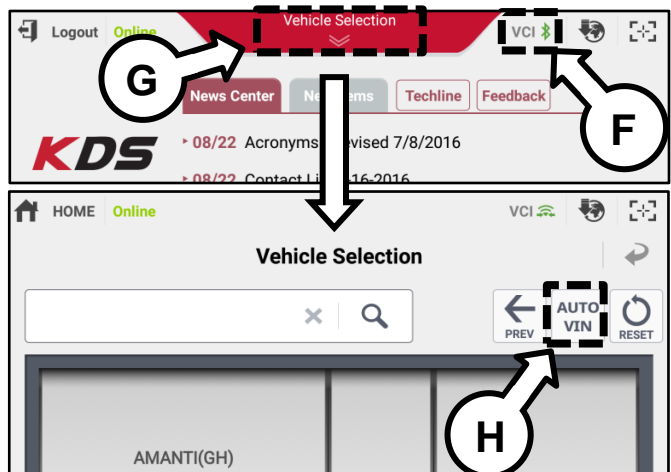

SUBJECT: ENGINE REPLACEMENT INSTRUCTIONS FOR DTC P1326 (PI1803W/X)

- Swipe up the “More” tab from the lower screen of the KDS and select “Special Inspection”.

*** NOTICE**

If the vehicle model/model year does not qualify for this campaign, a message will pop up; if so, verify that the vehicle is included in the list of affected VINs.

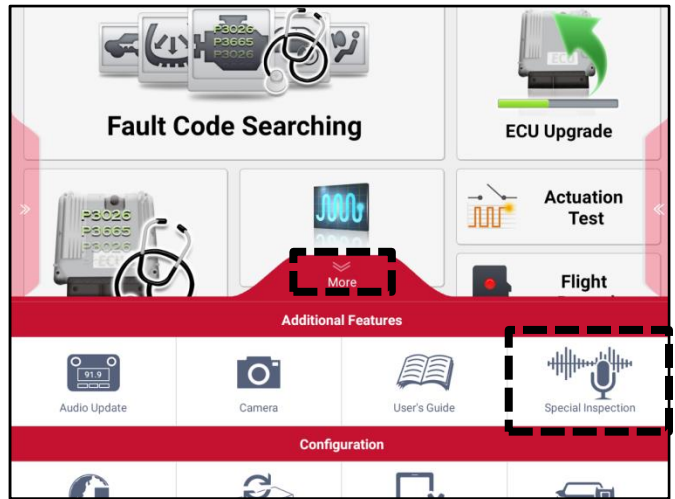

- Complete the vehicle information form on the screen:
 - Mileage
 - RO number
 - Select “Verify” to verify the VIN

Note: VIN must be verified with the “Verify” function in order to proceed to the next step.

Select “Next” to continue.

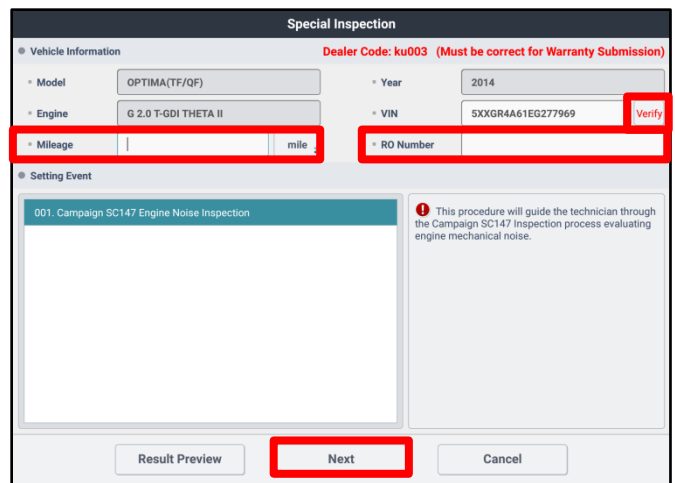

- Confirm that all of the pre-inspection items listed on the screen are true:

- Engine Oil Level – Normal
- Coolant Level – Normal
- Engine Cover – Installed
- Driver Window – Opened
- A/C & Blower Motor – OFF
- Audio & All Accessories – OFF
- Engine – Warm up (185°F or higher)
- Insert “A” into dipstick tube
- Connect “B” part at tablet headphone port

Select “Next” after checking items mentioned above.

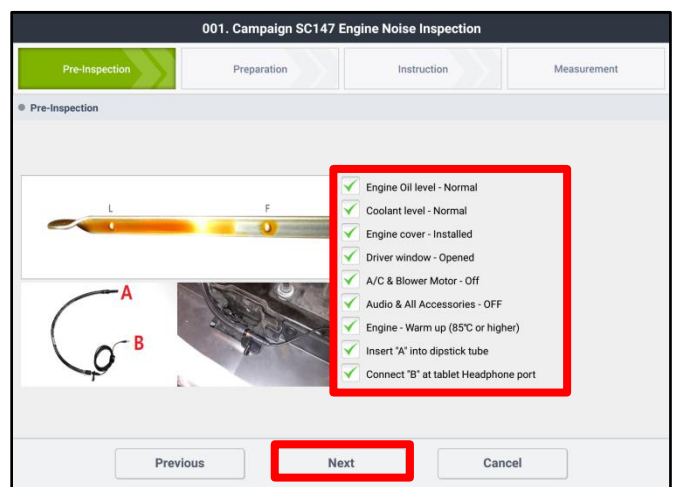

SUBJECT: ENGINE REPLACEMENT INSTRUCTIONS FOR DTC P1326 (P11803W/X)

12. The program will automatically check the engine sensors' data. Select the "Next" button if all the conditions are satisfied.
- Engine Coolant Temperature: 185°F or higher
 - A/C Request to ECU: OFF

Note: If the test item result is "NOT GOOD", correct the condition then select "Refresh Data".

001. Campaign SC147 Engine Noise Inspection

Pre-Inspection Preparation Instruction Measurement

Preparation

All Results below must be "GOOD" before proceeding.

Test Item	Value	Unit	Result
Engine Coolant Temperature	185.0	°F	GOOD
A/C Request to ECU	OFF	-	GOOD

Previous Next Cancel

13. Follow the instructions on the screen then select "Next".

001. Campaign SC147 Engine Noise Inspection

Pre-Inspection Preparation Instruction Measurement

Instruction

• Inspection should be performed in an area where wifi connectivity is available.

• Make sure tubing is not kinked or pinched.

• Open the driver's window. Run engine noise inspection tool through windows.

• Make sure Engine Noise Inspection Tool has clear path to the tablet.

• Do not tap or pinch Engine Noise Inspection Tool during measurement.

• Engine should be at normal operating temperature and must be higher than 85 degrees Celsius.

• Enable the tablet mute function so that the touch tone and all other audio notifications are disabled.

Test Procedure

- Step 1 - Inspection tool preparation (2000-3000rpm 30 sec)
- Step 2 - 2000 rpm test (2000rpm)
- Step 3 - Idle test (550-800rpm)

Previous Next Cancel

14. Prior to the initial measurement, the program will automatically check if the engine noise tester is installed and operating correctly at engine idle and perform an internal diagnosis.

Begin the second part of the engine noise tester check by selecting "Start".

★ NOTICE

If the measured noise level is too low or abnormally high, an engine noise tester inspection message will pop up. Check and correct as necessary and start again.

Pre-Inspection Preparation Instruction Measurement

Engine Noise

Press Start Button

704 rpm

2000rpm Test
- Maintain engine rpm between 1,900-2,200 until 3 tests are completed.

Measurement 1 of 3 Pending
Measurement 2 of 3 Pending
Measurement 3 of 3 Pending

Idle Test
- Maintain engine rpm between 550-800 until 3 tests are completed.

Measurement 1 of 3 Pending
Measurement 2 of 3 Pending
Measurement 3 of 3 Pending

Previous Restart Cancel

IMPORTANT
A/T in Park with Parking brake applied.
M/T in Neutral with Parking brake applied.

SUBJECT: ENGINE REPLACEMENT INSTRUCTIONS FOR DTC P1326 (PI1803W/X)

- With the vehicle in Park (A/T) / Neutral (M/T), increase and maintain the engine speed at 2,000-3,000 RPM for thirty (30) seconds.

The program will automatically proceed to the next step when the engine noise tester is ready.

*** NOTICE**

Once the RPM is in the specified range, the time count (green bars) will be initialized.

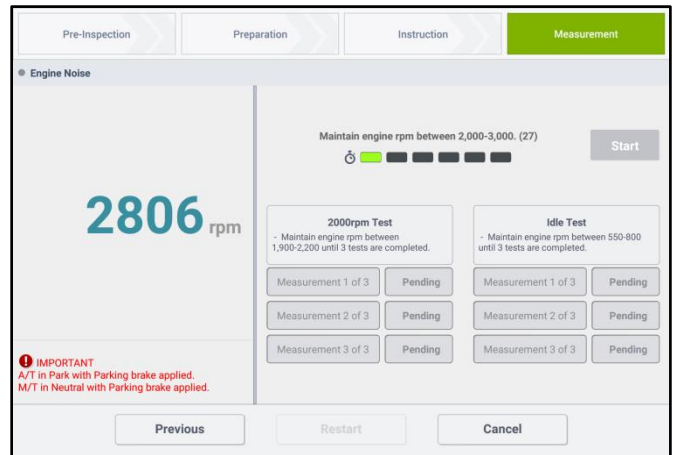

- With the vehicle in Park (A/T) / Neutral (M/T), begin the “2000rpm Test” by increasing and maintaining engine speed between 1,900-2,100 (2.4L) or 1,900-2,200 (2.0T) RPM until all three (3) measurements are complete.

- When the “2000rpm Test” is complete, release the accelerator pedal so that engine maintains idle state for the “Idle Test”.

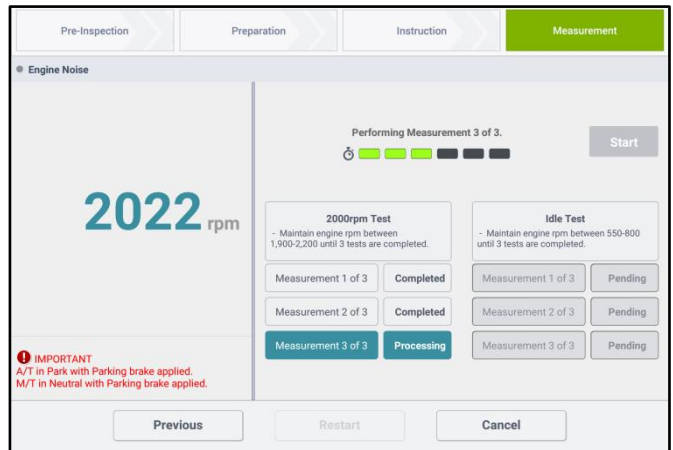

- The “Idle Test” will automatically begin. Keep the engine at idle and wait until all three (3) measurements are complete.

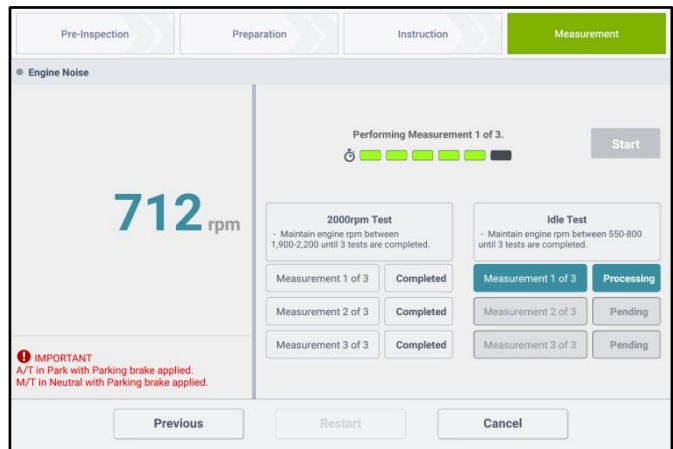

SUBJECT: ENGINE REPLACEMENT INSTRUCTIONS FOR DTC P1326 (PI1803W/X)

19. After the completion of the engine noise inspection, the KDS will automatically generate/display a “PASS” or “NO PASS” result.

- If the inspection result is “PASS”, proceed to the KS Extension Harness Installation procedure on page 12.
- If the inspection result is “NO PASS,” proceed to the engine replacement procedure on page 17.
- If the inspection result is “RETEST” with an error code, see Adapter Error Code chart in Appendix 3 on page 35 for corrective action then repeat the inspection procedure starting from step 9.

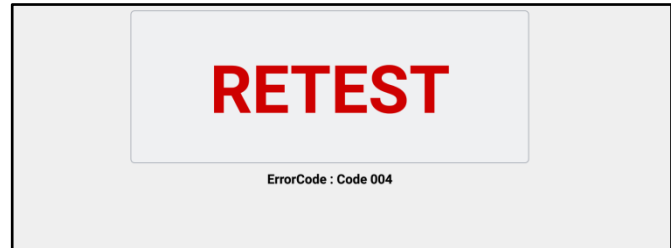

20. Select “Finish” to complete the engine noise inspection. Ensure the KDS is connected to the internet and the “Special Inspection” KDS application is open to automatically submit the results to the Kia Server. To save and/or print the results as PDF, select “Print”.

If the KDS is not connected to the internet, up to five (5) results will stay pending in the queue until the KDS is connected to the internet with the “Special Inspection” application open.

Note: The five (5) pending results must be submitted before a sixth (6th) test can be conducted.

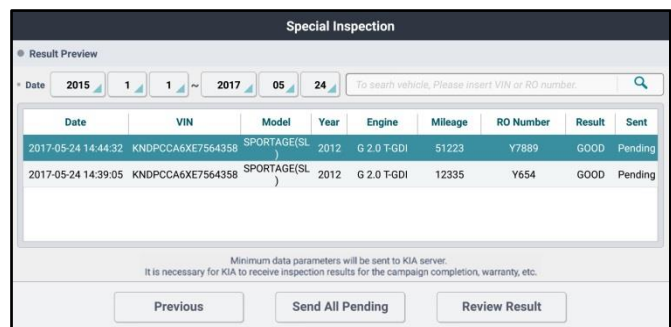
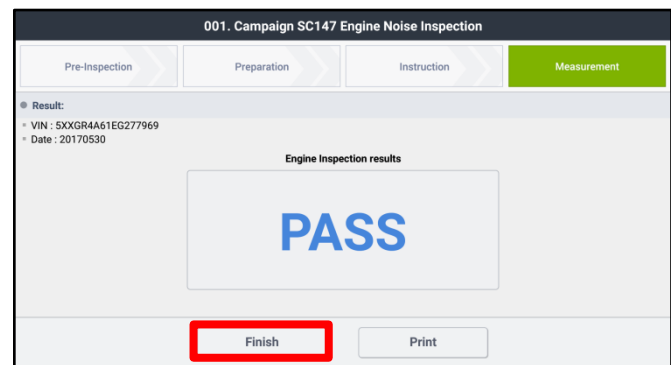

21. Disconnect the engine noise tester from the KDS and carefully remove the adapter (B) from the dipstick tube by grasping the engine noise tester adapter.

KS Extension Harness Installation Procedure:

NOTE: Photos below are from a 15MY Optima (QF). Components and their location may vary in different models.

1. Inspect the ECU harness (A) and verify if the Knock Sensor wiring extension harness (B) has previously been installed.

NOTE: To identify the extension harness (B), look for an external harness (B) which should be cable-tied to the existing wiring harness (A) leading by the intake manifold (C) to the knock sensor (D), as shown.

- If the extension harness (B) has been installed, open a Techline case online.
- If the extension harness (B) has not been installed, proceed to the next step.

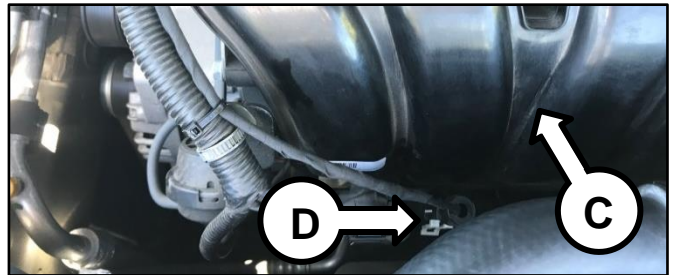
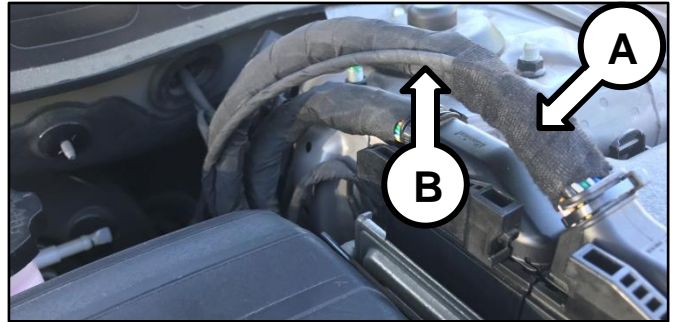

2. Remove the air cleaner and duct assembly (E).

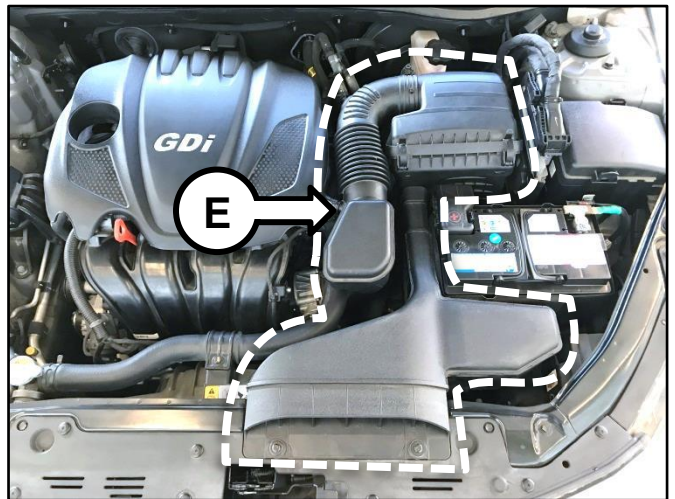

3. Disconnect the ECU connector* (figure F1 or F2) (*see IMPORTANT note below).

*** IMPORTANT**

Location of the ECU connector may vary from model to model. Refer to the table on page 13 for the ECU connector number and the applicable ETM Manual on KGIS for the location of the ECU connector.

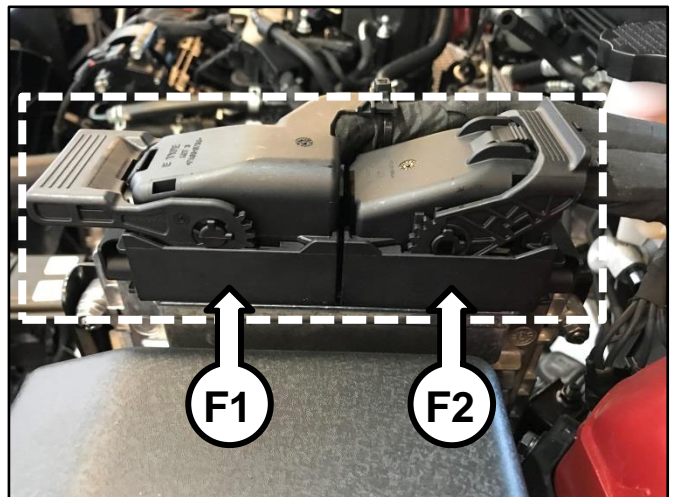

SUBJECT: ENGINE REPLACEMENT INSTRUCTIONS FOR DTC P1326 (P11803W/X)

MY	Model	Engine	ECU Connector Number
2011-2013	TF	2.4	CHG-BG
		2.0T	CHTG-BG
2014	QF	2.4	C200-B
		2.0T	C100-B
2011-2013	SL	2.0T	CHTG-BG
2012-2013	XMa	2.4	CHGG-B
2014			C300-B

4. Cut the existing cable-tie (G) from the connector.

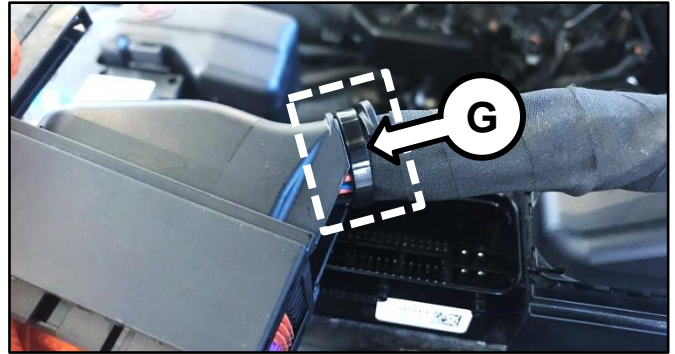

5. Remove the ECU connector cover (H) by carefully unclipping the two (2) tabs (I) and sliding the cover (H) towards the tabs (I).

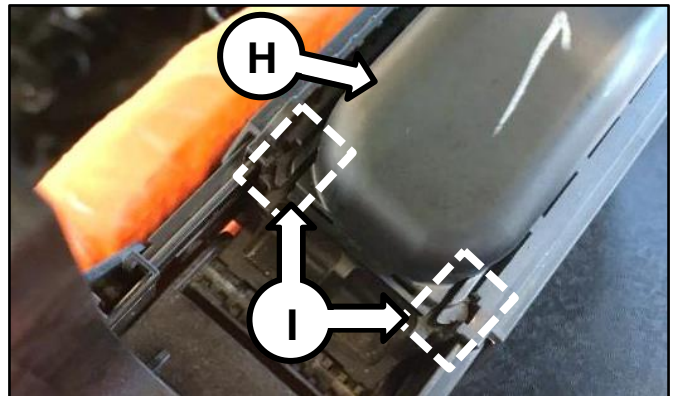

6. Carefully remove the electrical tape (J) to expose the harness wires.

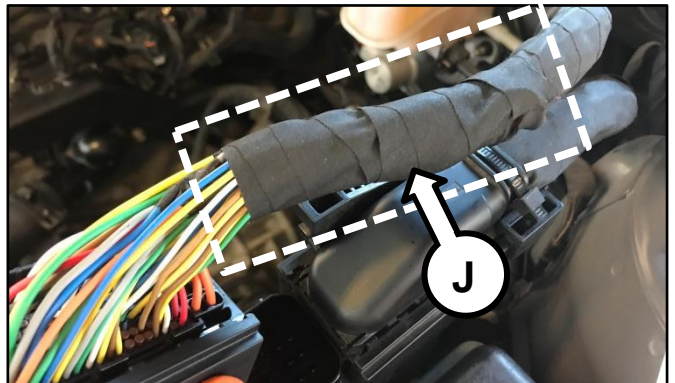

7. Remove the pin retainer (K).

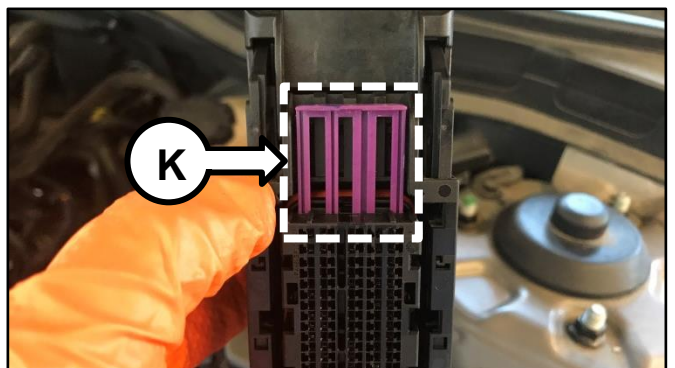

SUBJECT: ENGINE REPLACEMENT INSTRUCTIONS FOR DTC P1326 (PI1803W/X)

8. Locate the three (3) knock sensor circuit terminals from the ECU connector. Refer to the “Schematic Diagrams → Engine Electrical System → Engine Control System → Schematic Diagrams” chapter of the applicable ETM on KGIS.

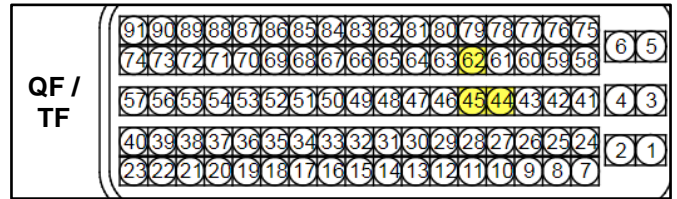

- 44. Knock Sensor Shielded Ground
- 45. Knock Sensor Ground
- 62. Knock Sensor Interface (Signal)

[Click here to see a video of terminal removal.](#)

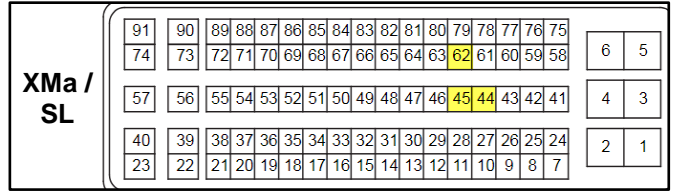

9. Remove the three (3) terminals **one at a time** and insert the new terminals of the extension harness into the ECU connector (F). Reinstall pin retainer (K) and reassemble the connector (F).



Pin	Extension Wire Color
44	Blue
45	Black
62	Red

NOTE: Be sure to note the rotational position of the terminals during removal. They are directional and need to be reinstalled in the same “clock” position.

10. Route the extension harness (B) along the existing harness (A) leading by the intake manifold (C) to the knock sensor (D), **exactly** as shown.

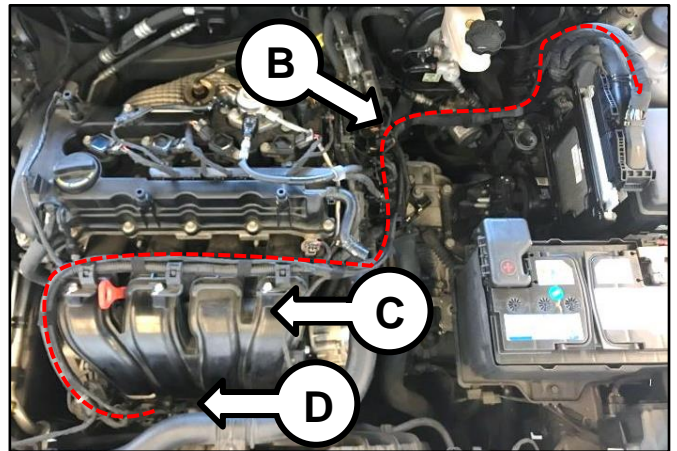

*** IMPORTANT**

The harness (B) must be routed exactly as shown to prevent related DTCs.

*** IMPORTANT**

The harness (B) must be routed above and secured to the harness protector (L1) and **UNDER** the Breather Hose (L2) and Camshaft Position Sensor (L3).

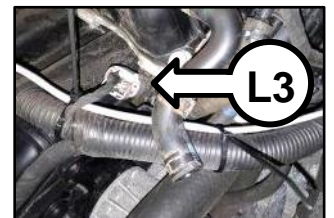
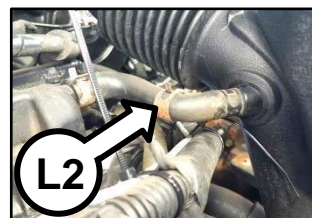

SUBJECT: ENGINE REPLACEMENT INSTRUCTIONS FOR DTC P1326 (P11803W/X)

11. Connect the extension harness (B) to the knock sensor (D).

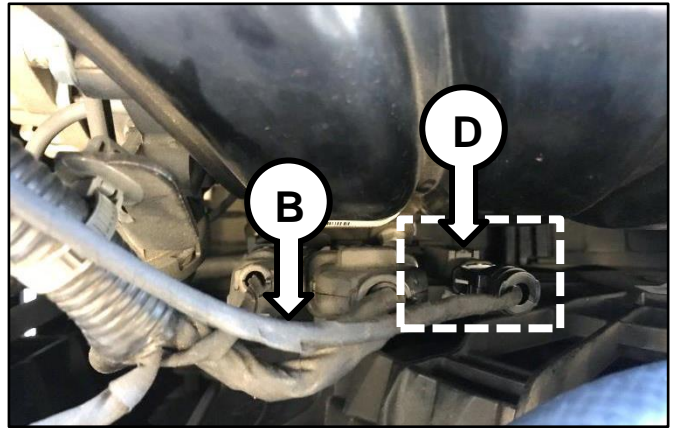

12. Cut off and discard the three (3) old knock sensor circuit terminals and the old knock sensor connector and secure the remaining wires to the new extension harness using the supplied electrical tape. **NOTE:** Complete removal of the old knock sensor wires is not necessary. Only remove the old terminals and connector.

13. Secure the extension harness at the connector (F) by replacing the cable-tie (G) removed in step 4 with a new supplied cable-tie and the electrical tape (J) removed in step 6 with new supplied electrical tape.

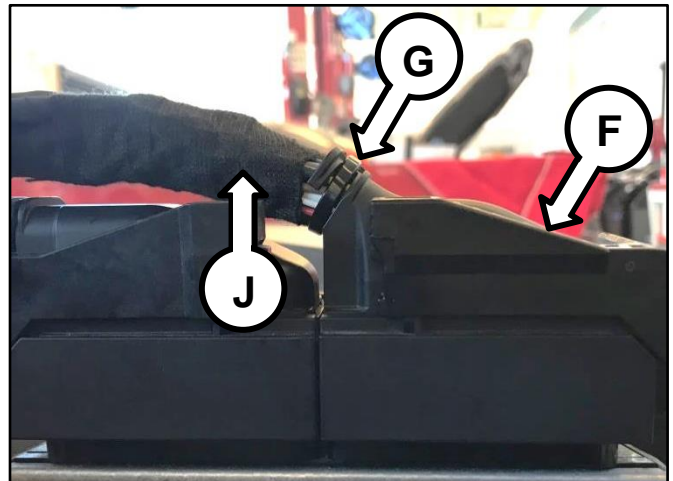

14. Secure the extension harness (B) to the existing harness (A) using the supplied cable-ties. Tuck and secure any excess wiring of the extension harness near the ECU with cable-tie.

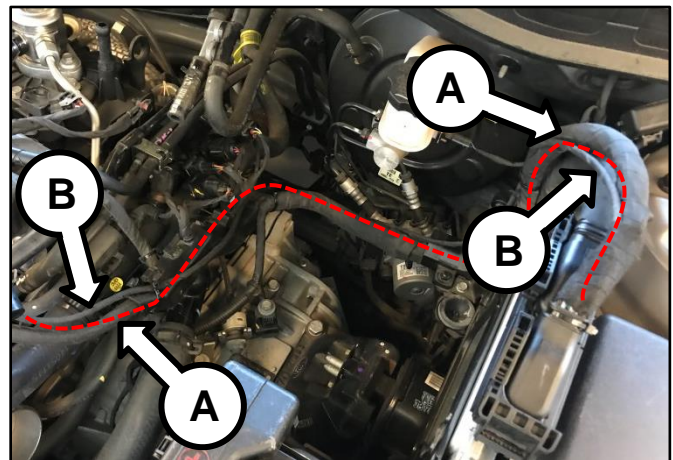

15. Reinstall all removed components in the reverse order of removal.
16. Erase the P1326 DTC with the KDS and start the engine to confirm proper operation.

Engine Replacement Procedure:

1. Remove the engine assembly by referring to the “Engine And Transmission (Transaxle) Assembly → Engine And Transmission (Transaxle) Assembly → Repair procedures” chapter in the applicable Shop Manual on KGIS.

Refer to [TSB ENG190](#) for information regarding engine replacement practices.



2. After removal of the engine from the vehicle, remove all components that will need to be transferred by referring to the applicable Shop Manual on KGIS.
3. Place the new engine block on an engine stand.
4. Install all removed components from the old engine block onto the new engine block utilizing all parts from Service Kit I and II. Be advised of notes below.

Tightening torque for Knock Sensor:

13.7 – 17.4 lb.ft (18.6 – 23.5 N.m, 1.9 – 2.4 kgf.m)

Notes:

High Pressure Pump & Roller Tappet:

- Refer to [TSB ENG083](#) for special attention and handling procedures of GDI-specific components.
- When installing the high pressure pump and roller tappet onto the new engine, apply engine oil to the roller tappet, and O-rings of the high pressure pump.

Tightening torques of pump bolts:

**9.4 – 10.9 lb.ft (12.8 – 14.7 N.m,
1.3 – 1.5 kgf.m)**

Tightening torques of pipe flare nut:

**19.5 – 23.9 lb.ft (26.5 – 32.4 N.m,
2.7 – 3.3 kgf.m)**

*** NOTICE**

Refer to [TSB ENG083](#) for gasoline direct injection (GDI) specific information, including related warnings and cautions for handling high fuel pressure system components.

SUBJECT: ENGINE REPLACEMENT INSTRUCTIONS FOR DTC P1326 (P11803W/X)
High Pressure Fuel Pipe:

1. Properly position the new fuel pipe (A) and then hand-tighten both flare nuts (B).

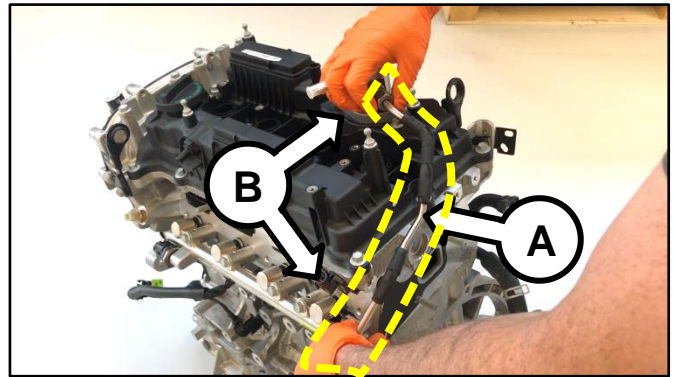

2. Install the pipe retaining bracket and bolt (C) and torque to specifications.

*** NOTICE**

If the bracket and bolt are missing, order and install a new bracket and bolt.

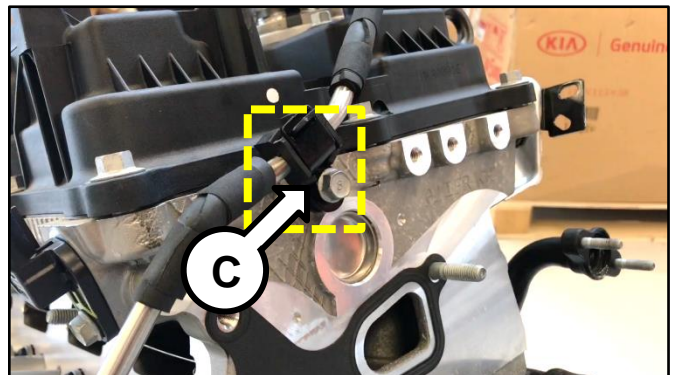

Tightening torque (bracket bolt):
 5.8 – 8.7 lb.ft (7.8 – 11.8 N.m,
 0.8 – 1.2 kgf.m)

3. Using a click-type/electronic torque wrench and SST 09314-3Q100, torque both flare nuts (B) to specifications.

Tightening torque (flare nuts):
 19.5 – 23.9 lb.ft (26.5 – 32.4 N.m,
 2.7 – 3.3 kgf.m)

[Click here to see a video tutorial of high pressure fuel pipe install \(includes high pressure pump install\).](#)

*** IMPORTANT**

The high pressure fuel pipe bracket and bolt must be installed and properly torqued prior to torquing the high pressure fuel pipe flare nuts.

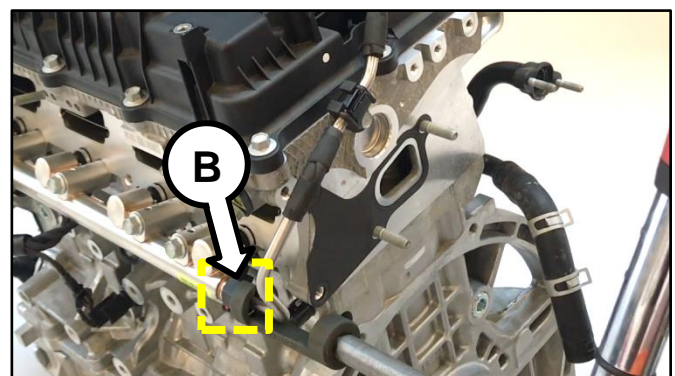
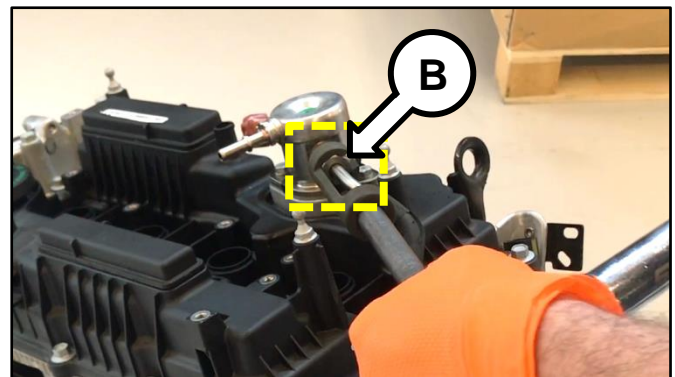

Delivery Pipe:

- Refer to [TSB ENG083](#) for special attention and handling procedures of GDI-specific components.
- Prior to installing the delivery pipe, be sure to replace all of the injector O-rings and injector retainers.
- Prior to installing the delivery pipe, apply engine oil to the injector O-rings.
- When installing the delivery pipe, use caution not to damage the tip of the injector.
- Be sure to replace the delivery pipe retaining bolts and torque them in the sequence shown.

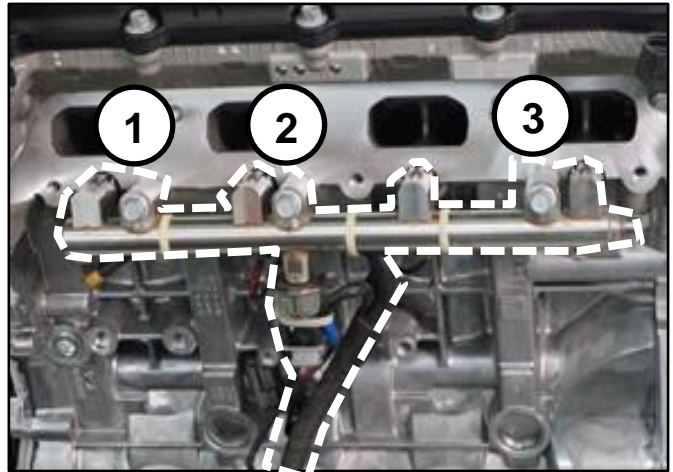
**Tightening torque of bolts:**

**13.7 – 17.4 lb.ft (18.6 – 23.5 N.m,
1.9 – 2.4 kgf.m)**

*** NOTICE**

Combustion seals must be compressed after installation and before attempting to install into the cylinder head. Use SST 09353 2B000 (refer to [TSB ENG083](#)).

Dipstick Tube & Dipstick:

- Prior to installing the new tube, lubricate the o-ring located at the bottom of the tube with engine oil.
- Install the red dipstick included in Service Kit I.

Tightening torque of bolt:

**5.8 – 8.7 lb.ft (7.8 – 11.8 N.m,
0.8 - 1.2 kgf.m)**

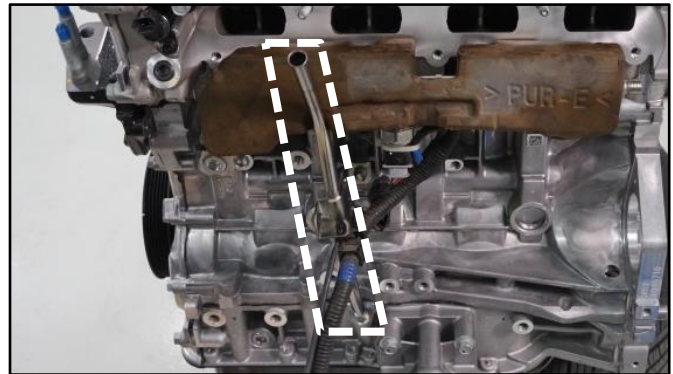
**Intake Manifold:**

- Prior to installation, replace the intake manifold gaskets.
- Torque bolts in the sequence shown.

Tightening torque of bolts:

**13.7 – 17.4 lb.ft (18.6 – 23.5 N.m,
1.9 – 2.4 kgf.m)**

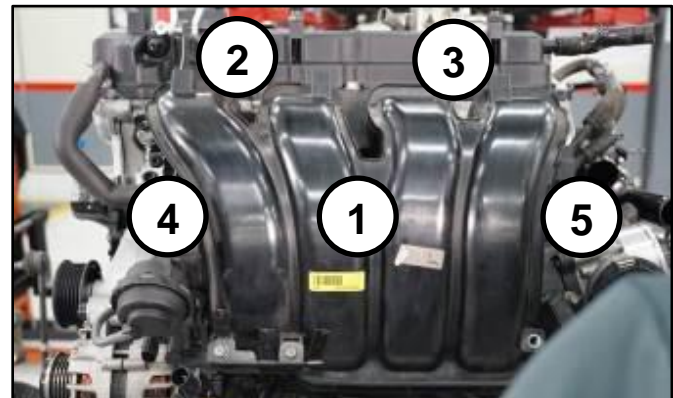

SUBJECT: ENGINE REPLACEMENT INSTRUCTIONS FOR DTC P1326 (P11803W/X)
Exhaust Manifold:

- All engines supplied under this Product Improvement Campaign have the exhaust manifold studs configured for SULEV engines.
- Using the pictures to the right, check the exhaust manifold stud location and quantity. Relocate as required for ULEV engines and obtain one (1) extra from the removed engine.
- Prior to installation, replace the exhaust manifold gasket and front muffler gasket.
- Torque nuts in the sequence shown.

Tightening torque of nuts:

**36.2 – 39.7 lb.ft (49.0 – 53.9 N.m,
5.0 – 5.5 kgf.m)**

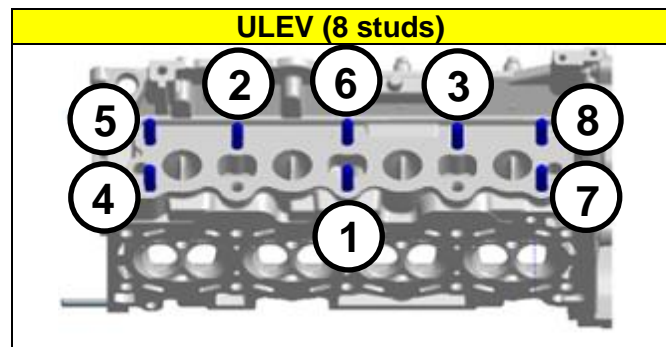
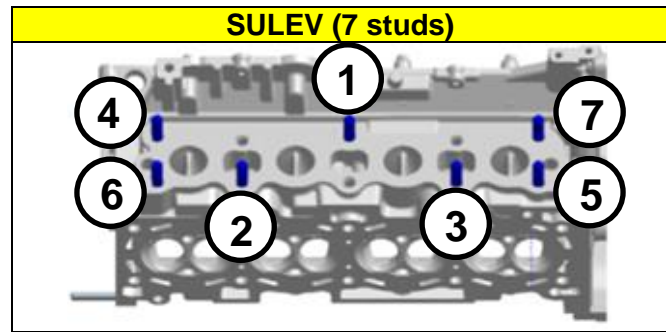

***For 14MY Sorento (XMa) vehicles only: check the underhood emissions label and record whether the label references ULEV or SULEV. This information is needed to select/order the correct replacement engine.**

KIA		KIA MOTORS CORPORATION VEHICLE EMISSION CONTROL INFORMATION	
Conforms to regulations :		2014 MY	
U.S.EPA : T2B5 LDV	OBD : CA II	Fuel : Gasoline	
California : ULEV	PC	OBD : CA II	Fuel : Gasoline
Group : EKMXV02.44PE	DFI/HO2S(2)/WU-TWC/TWC		
Evap. : EKMXR0130DRE	No adjustments needed.		A402
[WARNING]		35417-2G402	
Loaded I/M testing of permanent four-wheel drive or traction control-equipped vehicles must be conducted on a four-wheel drive speed synchronized dynamometer. Otherwise, a non-loaded test procedure must be performed.			

- On Turbo engines, replace the turbocharger oil feed line and gaskets.

Tightening torque of oil feed line bolt:

**8.7 – 13.0 lb.ft (11.8 – 17.7 N.m,
1.2 – 1.8 kgf.m)**

Tightening torque of oil feed line nuts:

**5.8 – 8.7 lb.ft (7.8 – 11.8 N.m,
0.8 – 1.2 kgf.m)**

Tightening torque of oil drain line nuts and bolts:

**5.8 – 8.7 lb.ft (7.8 – 11.8 N.m,
0.8 – 1.2 kgf.m)**

- Torque exhaust manifold nuts in the sequence shown.

Tightening torque of nuts:

**36.2 – 39.7 lb.ft (49.0 – 53.9 N.m,
5.0 – 5.5 kgf.m)**

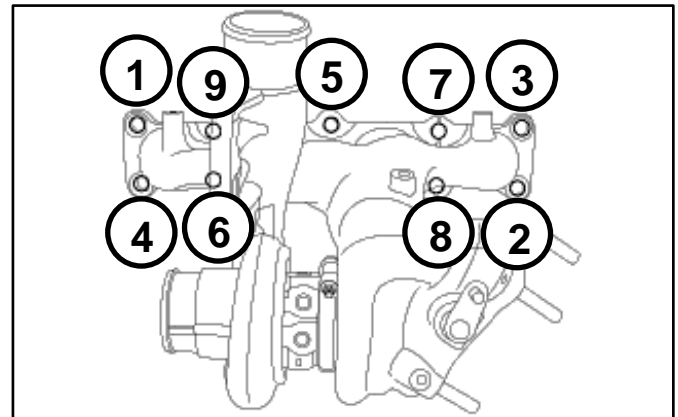

Oil Cooler Tube Assembly:

New engines may be supplied with a different oil cooler. Use steps below to determine the need for a replacement oil cooler tube assembly.

- If the new engine's (bigger) oil cooler (A) does not match the old engine's (smaller) oil cooler (B), replace the oil cooler tube assembly with the improved part. See parts table on page 23.
- If the new engine's (bigger) oil cooler (A) matches the old engine's (bigger) oil cooler (A), reuse the old engine's oil cooler tube assembly.
- If the new engine's (smaller) oil cooler (B) matches the old engine's (smaller) oil cooler (B), reuse the old engine's oil cooler tube assembly.

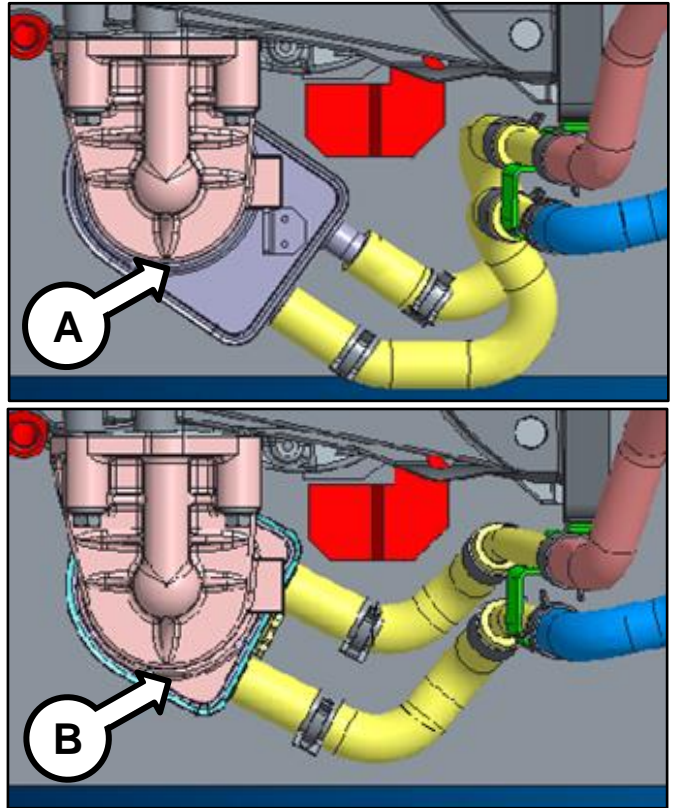

Drive Plate / Flywheel Bolts:

- Replace all seven (7) drive plate (AT) or flywheel (MT) bolts.

Tightening torque of nuts:

**86.8 – 93.9 lb.ft (117.7 – 125.5 N.m,
12.0 – 13.0 kgf.m)**

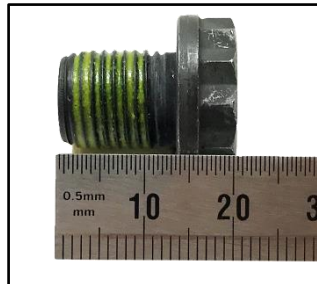

Drive Plate Bolt (A/T)

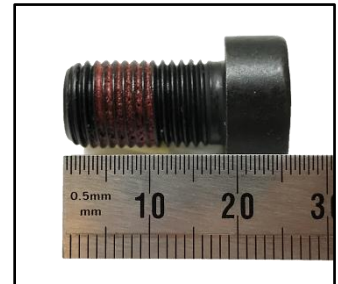

Flywheel Bolt (M/T)

Torque Converter

- If the torque converter has moved from the fully inserted position, carefully push inward while rotating the torque converter until it is recessed approximately 9/16 – 5/8" (14 – 16mm) (☑) into the transaxle case when reinstalling the automatic transaxle.

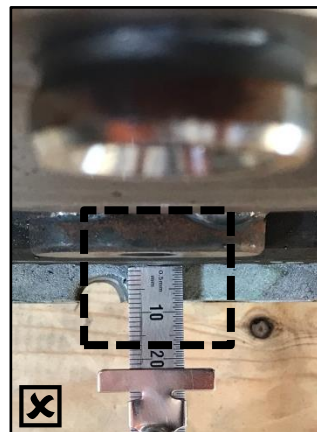

Not Fully Inserted

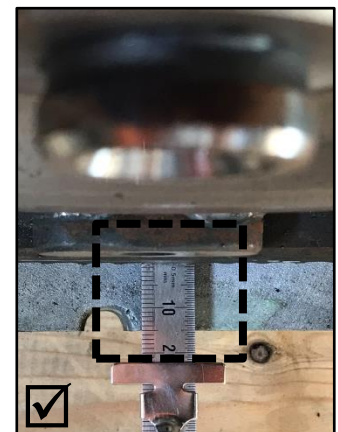

Fully Inserted

SUBJECT: ENGINE REPLACEMENT INSTRUCTIONS FOR DTC P1326 (P11803W/X)

5. Reinstall the assembled engine and transmission/transaxle into the vehicle.

Be sure to:

- Fill crankcase with 5W-30 oil (~5.8 quarts).
- Fill and bleed the cooling system with 50/50 coolant or mixture appropriate for area.
- Pressurize the fuel system before starting the vehicle.
- Reset engine adaptive values and perform steering angle sensor calibration.

Refer to [TSB ENG190](#) for information regarding engine replacement practices.

6. Verify proper operation of the vehicle with road test, and **with the engine ON (running), erase any stored DTCs** (e.g., EPS, ESC, and TPMS) that may have been set by this procedure. Verify no leaks exist and ensure engine oil and coolant are at their proper level.





If any DTCs are still active, follow any related diagnosis and repair as needed.

SUBJECT: ENGINE REPLACEMENT INSTRUCTIONS FOR DTC P1326 (PI1803W/X)

AFFECTED VEHICLE RANGE:

Model	Production Date Range
11-13MY Optima (QF/TF)	August 12, 2010 through September 27, 2013
14MY Optima (QF)	August 28, 2013 through May 15, 2014
12-14MY Sorento (XMa)	April 19, 2011 through February 10, 2014
11-13MY Sportage (SL)	December 30, 2010 through August 30, 2013



REQUIRED TOOL:

Tool Name	Tool Part No.	Figure	Comments
Torque Wrench Socket	09314 3Q100		Refer to TSB ENG083 for detailed usage instructions
Injector Combustion Seal Ring Installer	09353 2B000		
Pin Tool	91400 00000QQK		Auto-shipped to Dealers in 10/2018. Replacements can be ordered through Mobis Parts America.
Click-Type or Electronic Torque Wrench	N/A		Locally Sourced
Engine Noise Tester SST	GIT1XTDCP005		Auto-shipped to Dealers in June 2017 for SC147 For replacements, contact Snap-On Business Solutions at (888) 542-1011.





REQUIRED PARTS:

Part Name	MY	Model	Part Number		Figure
			2.4GDI	2.0T-GDI	
Engine Long Block	2011-2013	QF, TF	21101 2GK05QQKR	21101 2GK07QQKR	
		SL	-	21101 2GK07QQKR	
	2012-2013	XMa	21101 2GK09QQKR	-	
	2014	QF	21101 2GK06QQKR	21101 2GK08QQKR	
		XMa ULEV*	21101 2GK11QQKR	-	
		XMA SULEV*	21101 2GK11QQKR	-	

*See page 19 for details about underhood label check.

Part Name	Engine	Part Number	Figure
Service Kit I	2.4GDI	21111 2GK50QQK	
	2.0T-GDI	21111 2GK60QQK	

SUBJECT: ENGINE REPLACEMENT INSTRUCTIONS FOR DTC P1326 (PI1803W/X)

Part Name	Engine	Part Number	Figure
Service Kit II	2.4GDI and 2.0T-GDI	21111 2GK70QQK	
Drive Plate Bolts	2.4GDI and 2.0T-GDI	23311 25050	
		23231 25200 (MT)	
Oil Cooler Tube Assembly (replacement is conditional, refer to page 20)	2.4GDI	25470 2G050QQK	
	2.0T-GDI	25470 2G650QQK	
KS Extension Harness	2.4GDI and 2.0T-GDI	*91400 2T100QQK	

*NOTE: Old part number 91400 2T000QQK has been superseded by new part number 91400 2T100QQK.

WARRANTY INFORMATION (PI1803W1, MIL ON WITH P1326):

N Code: N99 C Code: C99

Model	Claim Type	Causal P/N	Qty.	Repair Description	Labor Op Code	Op Time	Replacement P/N	Qty.
Opt. (QF) 2.4L	R	23060 2G400	0	(PI1803W1) 2.4L GDI MIL ON with P1326, KSDS Wire Harness Inspection Pass, Engine Noise Inspection Pass, & KSDS Extension Harness Install	180A23R8	1.1 M/H	*91400 2T100QQK	1
				(PI1803W1) 2.4L GDI MIL ON with P1326, KSDS Wire Harness Inspection Pass, Engine Noise Inspection Fail, & Engine Replacement	180A23R0	8.7 M/H	21111 2GK50QQK	1
							21111 2GK70QQK	1
							(AT) 23311 25050	7
							(MT) 23231 25200	
							(11-13MY) 21101 2GK05QQKR	1
(14MY) 21101 2GK06QQKR								
(PI1803W1) 2.4L GDI MIL ON with P1326, KSDS Wire Harness Inspection Fail, KSDS Extension Harness Install	180A23R1	0.8 M/H	*91400 2T100QQK	1				

*NOTE: Old part number 91400 2T000QQK has been superseded by new part number 91400 2T100QQK.

SUBJECT: ENGINE REPLACEMENT INSTRUCTIONS FOR DTC P1326 (PI1803W/X)

Model	Claim Type	Causal P/N	Qty.	Repair Description	Labor Op Code	Op Time	Replacement P/N	Qty.
Opt. (QF) 2.0L T	R	23060 2G400	0	(PI1803W1) 2.0L T-GDI MIL ON with P1326, KSDS Wire Harness Inspection Pass, Engine Noise Inspection Pass, & KSDS Extension Harness Install	180A23R9	1.1 M/H	*91400 2T100QQK	1
				(PI1803W1) 2.0L T-GDI MIL ON with P1326, KSDS Wire Harness Inspection Pass, Engine Noise Inspection Fail, & Engine Replacement	180A23R2	8.9 M/H	21111 2GK60QQK	1
							21111 2GK70QQK	1
							(AT) 23311 25050	7
							(MT) 23231 25200	
							(11-13MY) 21101 2GK07QQKR	1
(14MY) 21101 2GK08QQKR								
(PI1803W1) 2.0L T-GDI MIL ON with P1326, KSDS Wire Harness Inspection Fail, KSDS Extension Harness Install	180A23R3	0.8 M/H	*91400 2T100QQK	1				
Opt. (TF) 2.4L	R	23060 2G400	0	(PI1803W1) 2.4L GDI MIL ON with P1326, KSDS Wire Harness Inspection Pass, Engine Noise Inspection Pass, & KSDS Extension Harness Install	180142RK	1.1 M/H	*91400 2T100QQK	1
				(PI1803W1) 2.4L GDI MIL ON with P1326, KSDS Wire Harness Inspection Pass, Engine Noise Inspection Fail, & Engine Replacement	180142R0	8.7 M/H	21111 2GK50QQK	1
							21111 2GK70QQK	1
							(AT) 23311 25050	7
							(MT) 23231 25200	
21101 2GK05QQKR	1							
(PI1803W1) 2.4L GDI MIL ON with P1326, KSDS Wire Harness Inspection Fail, KSDS Extension Harness Install	180142R5	0.8 M/H	*91400 2T100QQK	1				
Opt. (TF) 2.0L T	R	23060 2G400	0	(PI1803W1) 2.0L T-GDI MIL ON with P1326, KSDS Wire Harness Inspection Pass, Engine Noise Inspection Pass, & KSDS Extension Harness Install	180142RN	1.1 M/H	*91400 2T100QQK	1
				(PI1803W1) 2.0L T-GDI MIL ON with P1326, KSDS Wire Harness Inspection Pass, Engine Noise Inspection Fail, & Engine Replacement	180142R3	8.7 M/H	21111 2GK60QQK	1
							21111 2GK70QQK	1
							(AT) 23311 25050	7
							(MT) 23231 25200	
21101 2GK07QQKR	1							
(PI1803W1) 2.0L T-GDI MIL ON with P1326, KSDS Wire Harness Inspection Fail, KSDS Extension Harness Install	180142R8	0.8 M/H	*91400 2T100QQK	1				

*NOTE: Old part number 91400 2T000QQK has been superseded by new part number 91400 2T100QQK.

SUBJECT: ENGINE REPLACEMENT INSTRUCTIONS FOR DTC P1326 (PI1803W/X)

Model	Claim Type	Causal P/N	Qty.	Repair Description	Labor Op Code	Op Time	Replacement P/N	Qty.
Sor. (XMa) 2.4L	R	21020 2G010	0	(PI1803W1) 2.4L GDI 2WD MIL ON with P1326, KSDS Wire Harness Inspection Pass, Engine Noise Inspection Pass, & KSDS Extension Harness Install	180A24R8	1.1 M/H	*91400 2T100QQK	1
				(PI1803W1) 2.4L GDI 2WD MIL ON with P1326, KSDS Wire Harness Inspection Pass, Engine Noise Inspection Fail, & Engine Replacement	180A24R0	8.7 M/H	21111 2GK50QQK	1
							21111 2GK70QQK	1
							(AT) 23311 25050	7
							(MT) 23231 25200	
							(12-13MY) 21101 2GK09QQKR	1
							(14MY ULEV) 21101 2GK11QQKR	
				(14MY ULEV or SULEV) 21101 2GK11QQKR				
				(PI1803W1) 2.4L GDI 2WD MIL ON with P1326, KSDS Wire Harness Inspection Fail, KSDS Extension Harness Install	180A24R1	0.8 M/H	*91400 2T100QQK	1
				(PI1803W1) 2.4L GDI 4WD MIL ON with P1326, KSDS Wire Harness Inspection Pass, Engine Noise Inspection Pass, & KSDS Extension Harness Install	180A24R9	1.1 M/H	*91400 2T100QQK	1
				(PI1803W1) 2.4L GDI 4WD MIL ON with P1326, KSDS Wire Harness Inspection Pass, Engine Noise Inspection Fail, & Engine Replacement	180A24R2	8.9 M/H	21111 2GK50QQK	1
							21111 2GK70QQK	1
							(AT) 23311 25050	7
(MT) 23231 25200								
(12-13MY) 21101 2GK09QQKR	1							
(14MY ULEV) 21101 2GK11QQKR								
(14MY ULEV or SULEV) 21101 2GK11QQKR								
(PI1803W1) 2.4L GDI AWD MIL ON with P1326, KSDS Wire Harness Inspection Fail, KSDS Extension Harness Install	180A24R3	0.8 M/H	*91400 2T100QQK	1				

*NOTE: Old part number 91400 2T000QQK has been superseded by new part number 91400 2T100QQK.

SUBJECT: ENGINE REPLACEMENT INSTRUCTIONS FOR DTC P1326 (PI1803W/X)

Model	Claim Type	Causal P/N	Qty.	Repair Description	Labor Op Code	Op Time	Replacement P/N	Qty.
Spo. (SL) 2.0L T	R	23060 2G400	0	(PI1803W1) 2.0L T-GDI 2WD MIL ON with P1326, KSDS Wire Harness Inspection Pass, Engine Noise Inspection Pass, & KSDS Extension Harness Install	180143RN	1.2 M/H	*91400 2T100QQK	1
				(PI1803W1) 2.0L T-GDI 2WD MIL ON with P1326, KSDS Wire Harness Inspection Pass, Engine Noise Inspection Fail, & Engine Replacement	180143R3	8.0 M/H	21111 2GK60QQK	1
							21111 2GK70QQK	1
							(AT) 23311 25050	7
							(MT) 23231 25200	
				21101 2GK07QQKR	1			
				(PI1803W1) 2.0L T-GDI 2WD MIL ON with P1326, KSDS Wire Harness Inspection Fail, KSDS Extension Harness Install	180143R8	0.9 M/H	*91400 2T100QQK	1
				(PI1803W1) 2.0L T-GDI 4WD MIL ON with P1326, KSDS Wire Harness Inspection Pass, Engine Noise Inspection Pass, & KSDS Extension Harness Install	180143RO	1.2 M/H	*91400 2T100QQK	1
				(PI1803W1) 2.0L T-GDI 4WD MIL ON with P1326, KSDS Wire Harness Inspection Pass, Engine Noise Inspection Fail, & Engine Replacement	180143R4	8.4 M/H	21111 2GK60QQK	1
							21111 2GK70QQK	1
							(AT) 23311 25050	7
							(MT) 23231 25200	
21101 2GK07QQKR	1							
(PI1803W1) 2.0L T-GDI 4WD MIL ON with P1326, KSDS Wire Harness Inspection Fail, KSDS Extension Harness Install	180143R9	0.9 M/H	*91400 2T100QQK	1				

*NOTE: Old part number 91400 2T00QQK has been superseded by new part number 91400 2T100QQK.

SUBJECT: ENGINE REPLACEMENT INSTRUCTIONS FOR DTC P1326 (PI1803W/X)
WARRANTY INFORMATION (PI1803X1, ENGINE SEIZED/SEVERE KNOCKING):
N Code: N99 C Code: C99

Model	Claim Type	Causal P/N	Qty.	Repair Description	Labor Op Code	Op Time	Replacement P/N	Qty.
Opt. (QF) 2.4L	R	23060 2G400	0	(PI1803X1) 2.4L GDI Engine Seized / Severe Knocking, Techline Authorized Engine Replacement, KSDS Wire Harness Inspection Pass	180A23R4	8.4 M/H	21111 2GK50QQK	1
							21111 2GK70QQK	1
							(AT) 23311 25050	7
							(MT) 23231 25200	
							(11-13MY) 21101 2GK05QQKR	1
							(14MY) 21101 2GK06QQKR	
				(PI1803X1) 2.4L GDI Engine Seized / Severe Knocking, Techline Authorized Engine Replacement, KSDS Wire Harness Inspection Fail, KSDS Wire Harness Install	180A23R6	8.9 M/H	21111 2GK50QQK	1
							21111 2GK70QQK	1
							(AT) 23311 25050	7
							(MT) 23231 25200	
							(11-13MY) 21101 2GK05QQKR	1
							(14MY) 21101 2GK06QQKR	
*91400 2T100QQK	1							
Opt. (QF) 2.0L T	R	23060 2G400	0	(PI1803X1) 2.0L T-GDI Engine Seized / Severe Knocking, Techline Authorized Engine Replacement, KSDS Wire Harness Inspection Pass	180A23R5	8.7 M/H	21111 2GK60QQK	1
							21111 2GK70QQK	1
							(AT) 23311 25050	7
							(MT) 23231 25200	
							(11-13MY) 21101 2GK07QQKR	1
							(14MY) 21101 2GK08QQKR	
				(PI1803X1) 2.0L T-GDI Engine Seized / Severe Knocking, Techline Authorized Engine Replacement, KSDS Wire Harness Inspection Fail, KSDS Wire Harness Install	180A23R7	9.2 M/H	21111 2GK60QQK	1
							21111 2GK70QQK	1
							(AT) 23311 25050	7
							(MT) 23231 25200	
							(11-13MY) 21101 2GK07QQKR	1
							(14MY) 21101 2GK08QQKR	
*91400 2T100QQK	1							
Opt. (TF) 2.4L	R	23060 2G400	0	(PI1803X1) 2.4L GDI Engine Seized / Severe Knocking, Techline Authorized Engine Replacement, KSDS Wire Harness Inspection Pass	180142RA	8.4 M/H	21111 2GK50QQK	1
							21111 2GK70QQK	1
							(AT) 23311 25050	7
							(MT) 23231 25200	
							21101 2GK05QQKR	1
							(PI1803X1) 2.4L GDI Engine Seized / Severe Knocking, Techline Authorized Engine Replacement, KSDS Wire Harness Inspection Fail, KSDS Wire Harness Install	180142RF
				21111 2GK70QQK	1			
				(AT) 23311 25050	7			
				(MT) 23231 25200				
				21101 2GK05QQKR	1			
				*91400 2T100QQK	1			

*NOTE: Old part number 91400 2T000QQK has been superseded by new part number 91400 2T100QQK.

SUBJECT: ENGINE REPLACEMENT INSTRUCTIONS FOR DTC P1326 (PI1803W/X)

Model	Claim Type	Causal P/N	Qty.	Repair Description	Labor Op Code	Op Time	Replacement P/N	Qty.			
Opt. (TF) 2.0L T	R	23060 2G400	0	(PI1803X1) 2.0T-GDI Engine Seized / Severe Knocking, Techline Authorized Engine Replacement, KSDS Wire Harness Inspection Pass	180142RD	8.7 M/H	21111 2GK60QQK	1			
							21111 2GK70QQK	1			
							(AT) 23311 25050	7			
							(MT) 23231 25200				
				21101 2GK07QQKR	1						
				(PI1803X1) 2.0T-GDI Engine Seized / Severe Knocking, Techline Authorized Engine Replacement, KSDS Wire Harness Inspection Fail, KSDS Wire Harness Install	180142RI	9.2 M/H	21111 2GK60QQK	1			
							21111 2GK70QQK	1			
							(AT) 23311 25050	7			
							(MT) 23231 25200				
							21101 2GK07QQKR	1			
*91400 2T100QQK	1										
Sor. (XMa) 2.4L	R	21020 2G010	0	(PI1803X1) 2.4L GDI 2WD Engine Seized / Severe Knocking, Techline Authorized Engine Replacement, KSDS Wire Harness Inspection Pass	180A24R4	8.4 M/H	21111 2GK50QQK	1			
							21111 2GK70QQK	1			
							(AT) 23311 25050	7			
							(MT) 23231 25200				
							(12-13MY) 21101 2GK09QQKR	1			
							(14MY ULEV) 21101 2GK11QQKR				
							(14MY ULEV or SULEV) 21101 2GK11QQKR				
							(PI1803X1) 2.4L GDI 2WD Engine Seized / Severe Knocking, Techline Authorized Engine Replacement, KSDS Wire Harness Inspection Fail, KSDS Wire Harness Install	180A24R6	8.9 M/H	21111 2GK50QQK	1
										21111 2GK70QQK	1
										(AT) 23311 25050	7
										(MT) 23231 25200	
				(12-13MY) 21101 2GK09QQKR	1						
				(14MY ULEV) 21101 2GK11QQKR							
				(14MY ULEV or SULEV) 21101 2GK11QQKR							
				*91400 2T100QQK							
				(PI1803X1) 2.4L GDI AWD Engine Seized / Severe Knocking, Techline Authorized Engine Replacement, KSDS Wire Harness Inspection Pass	180A24R5	8.6 M/H	21111 2GK50QQK	1			
							21111 2GK70QQK	1			
							(AT) 23311 25050	7			
							(MT) 23231 25200				
							(12-13MY) 21101 2GK09QQKR	1			
							(14MY ULEV) 21101 2GK11QQKR				
							(14MY ULEV or SULEV) 21101 2GK11QQKR				
							(PI1803X1) 2.4L GDI AWD Engine Seized / Severe Knocking, Techline Authorized Engine Replacement, KSDS Wire Harness Inspection Fail, KSDS Wire Harness Install	180A24R7	9.1 M/H	21111 2GK50QQK	1
										21111 2GK70QQK	1
				(AT) 23311 25050	7						
				(MT) 23231 25200							
				(12-13MY) 21101 2GK09QQKR	1						
				(14MY ULEV) 21101 2GK11QQKR							
(14MY ULEV or SULEV) 21101 2GK11QQKR											
*91400 2T100QQK											

***NOTE: Old part number 91400 2T000QQK has been superseded by new part number 91400 2T100QQK.**

SUBJECT: ENGINE REPLACEMENT INSTRUCTIONS FOR DTC P1326 (PI1803W/X)

Model	Claim Type	Causal P/N	Qty.	Repair Description	Labor Op Code	Op Time	Replacement P/N	Qty.
Spo. (SL) 2.0L T	R	23060 2G400	0	(PI1803X1) 2.0L T-GDI 2WD Engine Seized / Severe Knocking, Techline Authorized Engine Replacement, KSDS Wire Harness Inspection Pass	180143RD	7.7 M/H	21111 2GK60QQK	1
							21111 2GK70QQK	1
							(AT) 23311 25050	7
							(MT) 23231 25200	
							21101 2GK07QQKR	1
				(PI1803X1) 2.0L T-GDI 2WD Engine Seized / Severe Knocking, Techline Authorized Engine Replacement, KSDS Wire Harness Inspection Fail, KSDS Wire Harness Install	180143RI	8.3 M/H	21111 2GK60QQK	1
							21111 2GK70QQK	1
							(AT) 23311 25050	7
							(MT) 23231 25200	
							21101 2GK07QQKR	1
				*91400 2T100QQK	1			
				(PI1803X1) 2.0L T-GDI AWD Engine Seized / Severe Knocking, Techline Authorized Engine Replacement, KSDS Wire Harness Inspection Pass	180143RE	8.1 M/H	21111 2GK60QQK	1
							21111 2GK70QQK	1
							(AT) 23311 25050	7
							(MT) 23231 25200	
							21101 2GK07QQKR	1
				(PI1803X1) 2.0L T-GDI AWD Engine Seized / Severe Knocking, Techline Authorized Engine Replacement, KSDS Wire Harness Inspection Fail, KSDS Wire Harness Install	180143RJ	8.7 M/H	21111 2GK60QQK	1
							21111 2GK70QQK	1
							(AT) 23311 25050	7
							(MT) 23231 25200	
21101 2GK07QQKR	1							
*91400 2T100QQK	1							

NOTE: Refer to Warranty Bulletin 2018-14 for details regarding coolant and substitute transportation reimbursement requirements.

***Old part number 91400 2T000QQK has been superseded by new part number 91400 2T100QQK.**

Use sublet code 'X3' with a maximum allowed amount of \$19.80 for "ENGINE R&R" engine oil reimbursement.

If the replacement of the Oil Cooler Tube Assembly was required, please manually enter the applicable Oil Cooler Tube Assembly part number to the claim's related parts section.

Dispose of old parts in accordance with local, state, and Federal regulations.

ALL claims for engine or harness replacement without the required diagnostic inspection/results or authorization are subject to claim chargeback/denial without exception.

* NOTICE

VIN inquiry data for this repair is provided for tracking purposes only. Kia retailers should reference PI1803W/X* when accessing the WebDCS system.

Appendix 1 (Warranty Claim Authorization)

Scenario	Description	Action Required
1 Campaign - TSB # PI1803W/X Case for Warranty Authorization NO INSPECTION	Wiring Signal Interference Check cannot be completed due to engine seizure or other engine failure (won't run long enough to complete the test)	<p>TL PWA required for all dealers – Video of condition and WRTY143 form required*</p> <p>Video requirement examples below are for illustration purposes, individual requirements will vary based upon the condition reported:</p> <ul style="list-style-type: none"> • Video should be continuous and show the VIN (most convenient VIN plate) and pan to show the engine condition • For engine seizures, attempt to turn over engine with breaker bar in video • For hole in engine block, show hole in video

Appendix 2 (Video Capture & Upload)

Capturing a video is often helpful in assisting the Kia Techline Agent in determining a proper diagnosis strategy. Once a TechLine case is open, the following procedure will guide you through the video capture and upload.

The Chrome™  browser should be used to access the Techline portal. Follow the steps below to clear the default browser if it is other than Chrome™.

For KDS Tab 10.1 Tablets:

1. Select “Settings” from the App Screen.
2. Select the “General” tab at the top.
3. Select “Default Applications”.
4. If “Internet” is the default browser, select the CLEAR button.
If “Chrome” is the default browser, further action is not required.

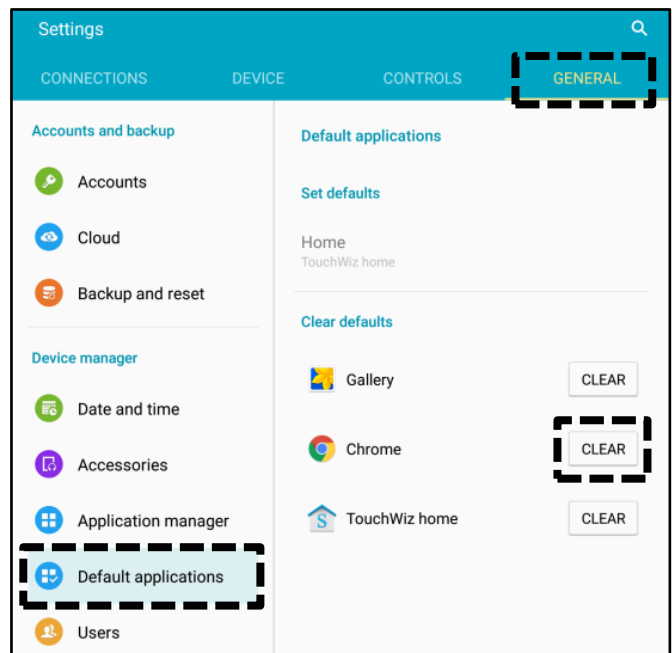

5. When opening the Techline portal, select “Chrome” and select Always”.

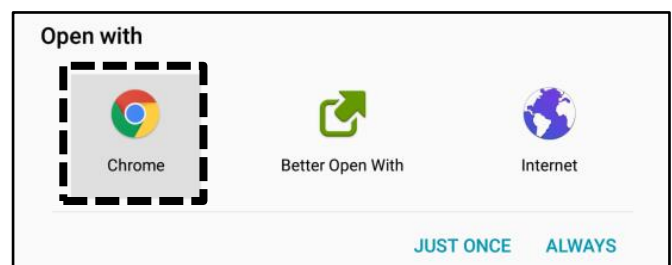

SUBJECT: ENGINE REPLACEMENT INSTRUCTIONS FOR DTC P1326 (PI1803W/X)
For KDS Tab S2 Tablets:

1. Select “Settings” from the App Screen.
2. Select “Applications”.
3. Select “Default Applications”.

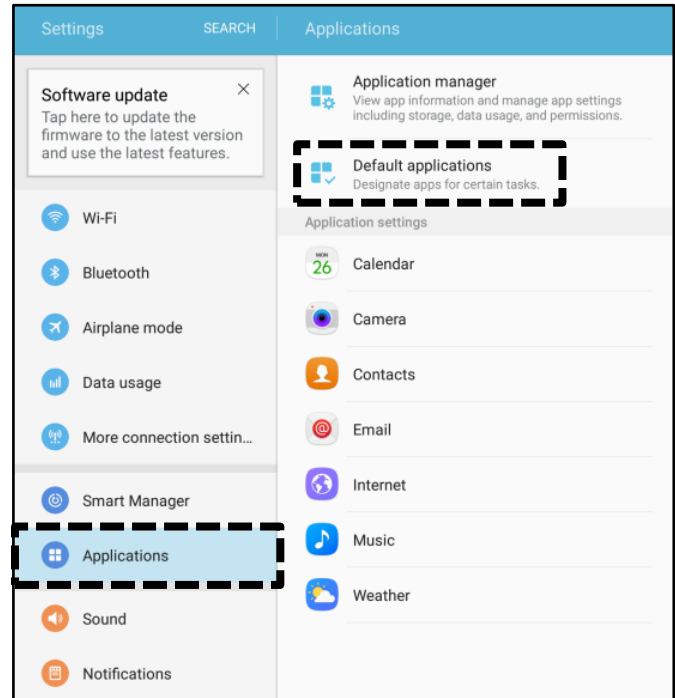

4. Select “Browser app”.

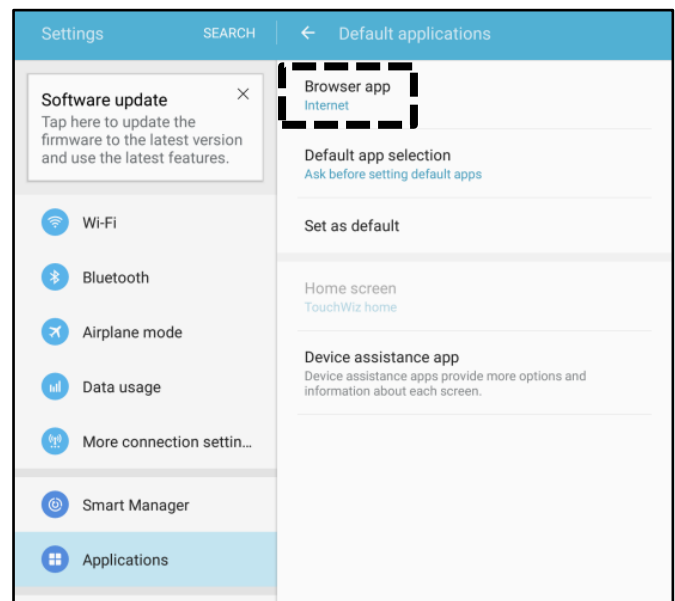

5. Ensure “Chrome” is selected.

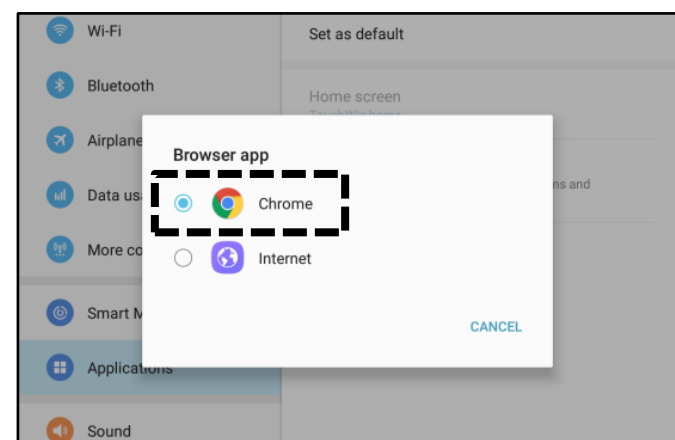

Setting Your Video Size to “Limit to Email”

1. Select “Camera” from the App Screen.

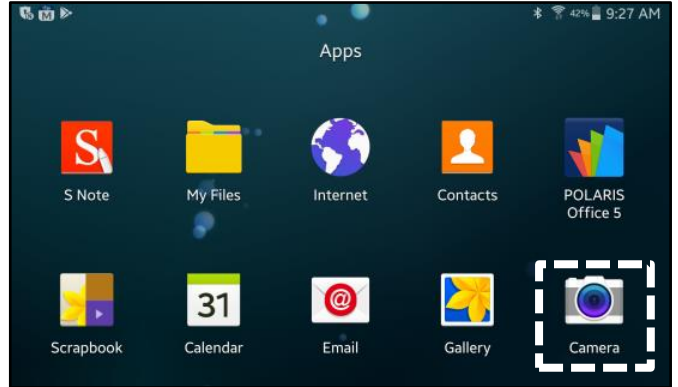

2. Select the Settings icon.



3. Select the Video Camera icon.



4. Ensure “Limit to email” is selected.

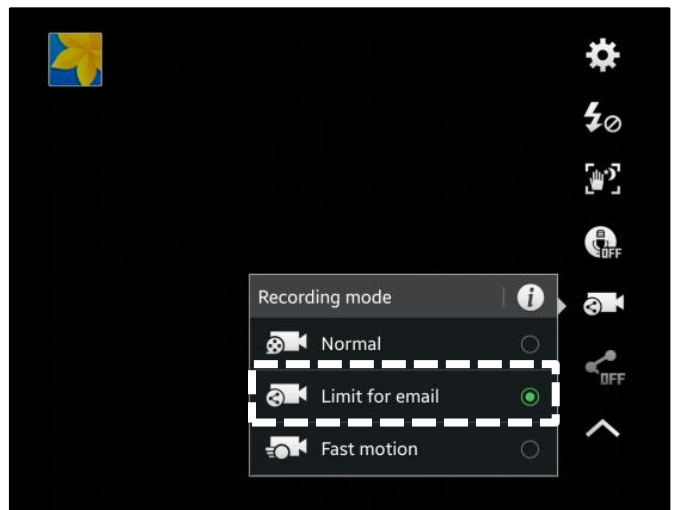

SUBJECT: ENGINE REPLACEMENT INSTRUCTIONS FOR DTC P1326 (P11803W/X)

Attaching Video to a Techline Case

1. Open K-Support in the device Chrome™ browser or select the “Techline” button on KDS home page.

<https://ksupport.kiausa.com>



2. Open your existing Techline case for the vehicle requiring a video capture by selecting the case number.

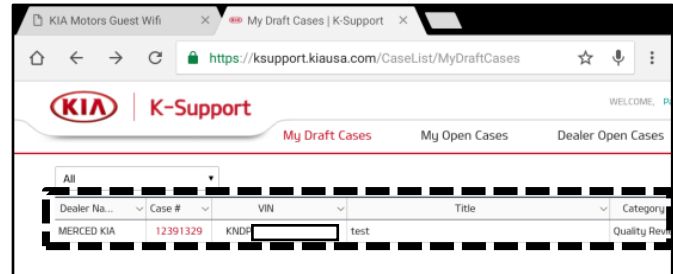

3. Select “Attachment”.

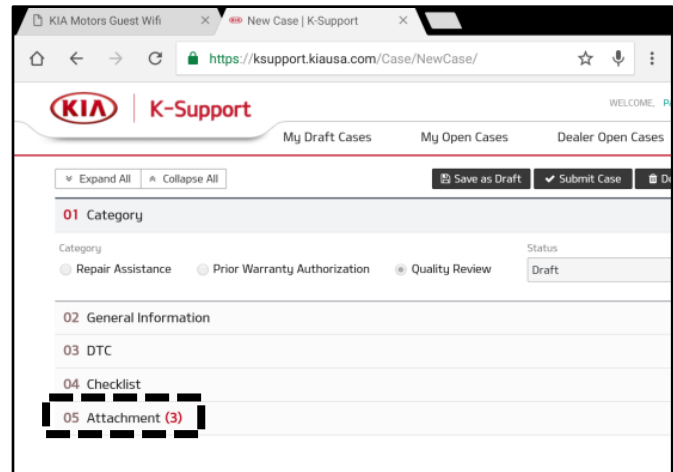

4. Select “Add Files”.

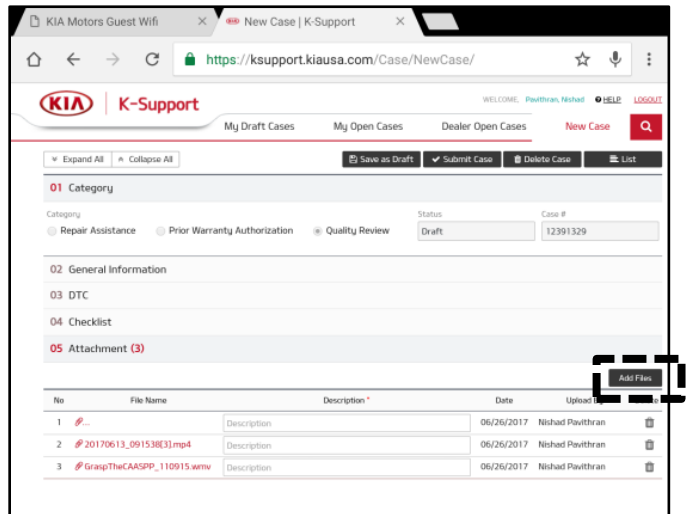

5. Select “Camcorder” and the video camera will open.

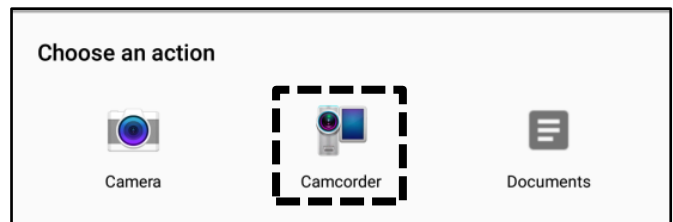

SUBJECT: ENGINE REPLACEMENT INSTRUCTIONS FOR DTC P1326 (PI1803W/X)

- Start by recording the VIN. Ensure sun glare is not reflecting off windows or other objects.

Without stopping the recording, capture the area of the vehicle displaying the issue. i.e.;

- Engine Noise – record the engine.
- Hole In Block – record the side of the engine with the damage.
- Seized Engine – record a technician trying to turn the engine over with a breaker bar.

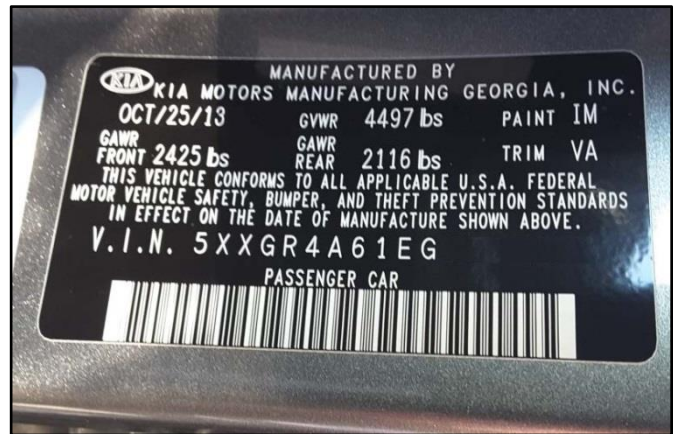

*** NOTICE**

NOTE: Ensure the video size is set to “Limit to email” (see page 32). Only record the VIN and the engine exhibiting the concern. Any additional information will increase the size of the video and make it difficult to upload or download.

- Stop the video when you captured what is needed. Select “OK” to use this capture or “RETRY” to capture the video again.
- Ensure a description of the recording. For example, engine knock or smoke from exhaust.
- Select “Submit Case”.

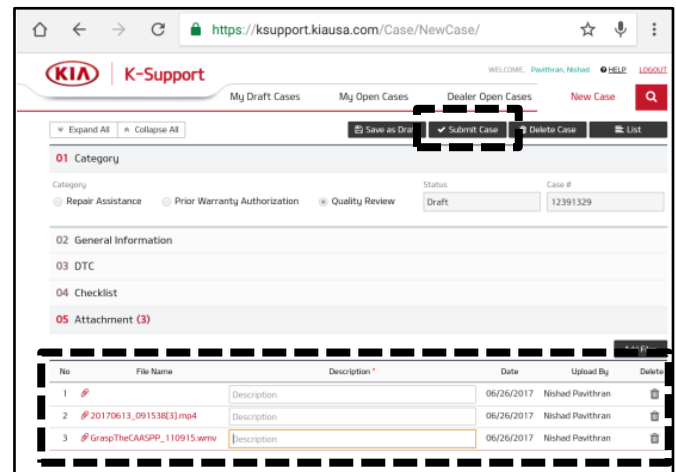

- Select “Yes” when the confirmation message below appears.

Note: Selecting anything other than “Yes” will not save the video capture.

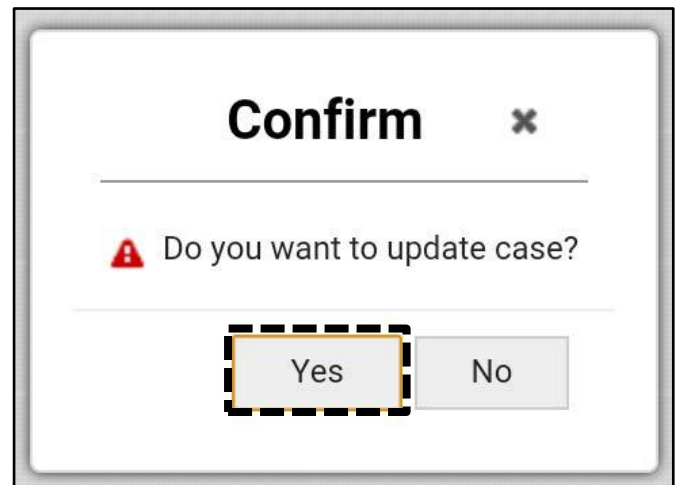

Appendix 3 (Engine Noise Adapter Threshold)

Code	Concern	Action
RETEST Code 001	Any measured value out of range / below lower limit	Contact GIT America
RETEST Code 002	Any measured value out of range / over upper limit	Contact GIT America
RETEST Code 003	Difference between minimum and maximum of 2000 RPM <u>or</u> Idle RPM measured value out of range	Perform Retest three (3) more times. If Error Code 003 still displays after the third attempt, contact GIT America.
RETEST Code 004	Difference between minimum and maximum of 2000 RPM <u>and</u> Idle RPM measured value out of range	Perform Retest three (3) more times. If Error Code 004 still displays after the third attempt, contact GIT America.
RETEST Code 005	The adapter/extension cable is unplugged or damaged after test started	Perform Retest three (3) more times. If Error Code 005 still displays after the third attempt, contact GIT America.

GIT America can be contacted at (888) 542-4371.