



# SERVICE BULLETIN

Classification: AT16-012i	Reference: NTB17-034i	Date: June 26, 2019
------------------------------	--------------------------	------------------------

## 2013-2017 SENTRA AND VERSA SEDAN, AND 2014-2017 VERSA NOTE; CVT JUDDER AND/OR P0746/P0965/P17F0/P0846 STORED

This bulletin has been amended. See **AMENDMENT HISTORY** on the last page.  
Please discard previous versions of this bulletin.

**APPLIED VEHICLES:** 2013 – 2017 Versa Sedan (N17)  
2014 – 2017 Versa NOTE (E12)  
2013 – 2017 Sentra (B17)

**APPLIED TRANSMISSION:** CVT (RE0F11A)

**APPLIED ENGINE:** HR16DE and MRA8DE (non turbo engines)

### IF YOU CONFIRM

The customer reports a transmission judder (shake, shudder, single or multiple bumps or vibration), hesitation on acceleration, lack of power or RPM flare.

### AND/OR

One of these DTCs is stored.

- **P0746 (PRES CNT SOL/A FCTN [L/PRESS SOL/FNCTN])**
- **P0965 (PRESSURE CONTROL SOLENOID B)**
- **P17F0 (CVT\_JUDDER [T/M INSPECTION])**
- **P0846 (TRANSMISSION FLUID PRESSURE SEN/SW B)**

### ACTION

- Refer to the **Repair Overview** on page 2.

**CAUTION:** Always handle the CVT and component assemblies carefully.

**IMPORTANT:** The purpose of **ACTION** (above) is to give you a quick idea of the work you will be performing. You **MUST** closely follow the entire **SERVICE PROCEDURE** as it contains information that is essential to successfully completing this repair.

Nissan Bulletins are intended for use by qualified technicians, not 'do-it-yourselfers'. Qualified technicians are properly trained individuals who have the equipment, tools, safety instruction, and know-how to do a job properly and safely. NOTE: If you believe that a described condition may apply to a particular vehicle, DO NOT assume that it does. See your Nissan dealer to determine if this applies to your vehicle.

# REPAIR OVERVIEW

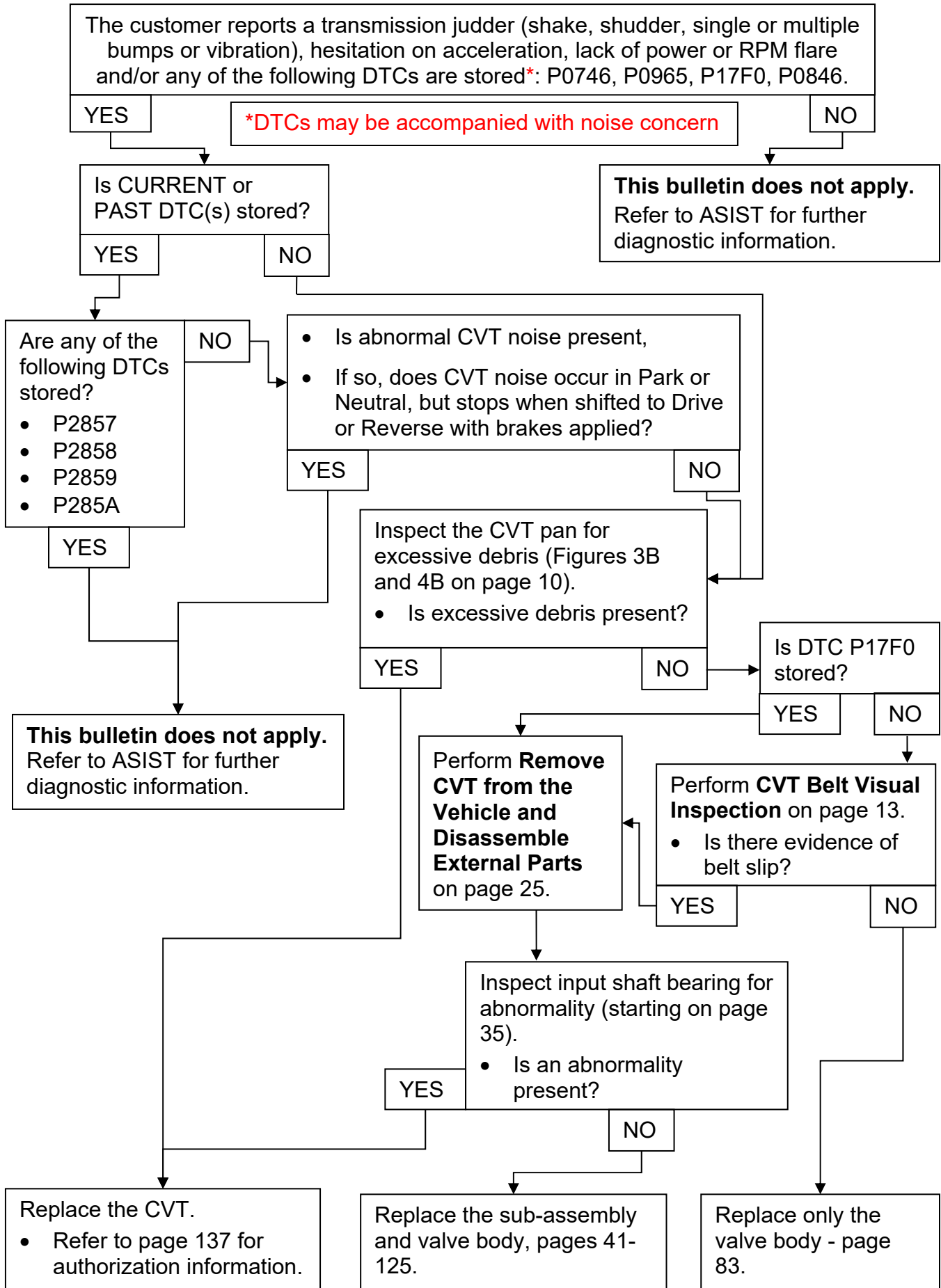

## Table of Contents

• Required Tools / Material.....	page 4
• Essential Tools.....	page 4
• Precautions when Disassembling a CVT Assembly.....	page 7
• Inspection for Abnormal Noise.....	page 7
• Control Valve (Valve Body) Removal.....	page 8
• CVT Belt Visual Inspection.....	page 13
• No Belt Damage – Only Valve Body is Replaced.....	page 24
• Belt Damaged.....	page 24
• Remove CVT from the Vehicle and Disassemble External Parts.....	page 25
• Remove the Oil Filter.....	page 27
• Remove the Oil Pan and Torque Converter Housing.....	page 29
• Remove the Oil Seals from the Torque Converter Housing.....	page 30
• Remove the CVT Internal Components.....	page 31
• Remove the Sub-assembly.....	page 41
• Clean the CVT Surfaces.....	page 47
• Clean Oil Passages in CVT Case and Oil Pump Cover.....	page 49
• Measuring the CVT Sub-assembly Case Depth.....	page 55
• New Snap Ring Selection and Installation to the New Sub-assembly.....	page 58
• Install Sub-assembly to CVT Case.....	page 64
• Install the Oil Pump and the Manual Shaft.....	page 69
• Install Powertrain Parts.....	page 72
• Install the Torque Converter Housing.....	page 80
• Install the Valve Body and Oil Pan.....	page 83
• Install and Adjust the Transmission Range Switch.....	page 91
• Install Exterior CVT Parts.....	page 92
• Install the CVT Assembly.....	page 97
• ADDITIONAL SERVICES REQUIRED.....	page 97
• PARTS INFORMATION.....	page 131
• CLAIMS INFORMATION.....	page 132
• KIT PARTS REFERENCE TABLE.....	page 134
• CVT Assembly Replacement Approval Procedures.....	page 137

## REQUIRED TOOLS / MATERIALS

- Petroleum jelly or equivalent
- Extendable magnet
- Large clean surface / 1 to 2 work tables
- Brake cleaner
- Rubbing alcohol
- Plastic scraper
- Mallet
- Sandpaper

## Essential Special Service Tools

Additional Essential Tools are available from Tech•Mate online:  
[www.nissantechmate.com](http://www.nissantechmate.com), or by phone: 1-800-662-2001.

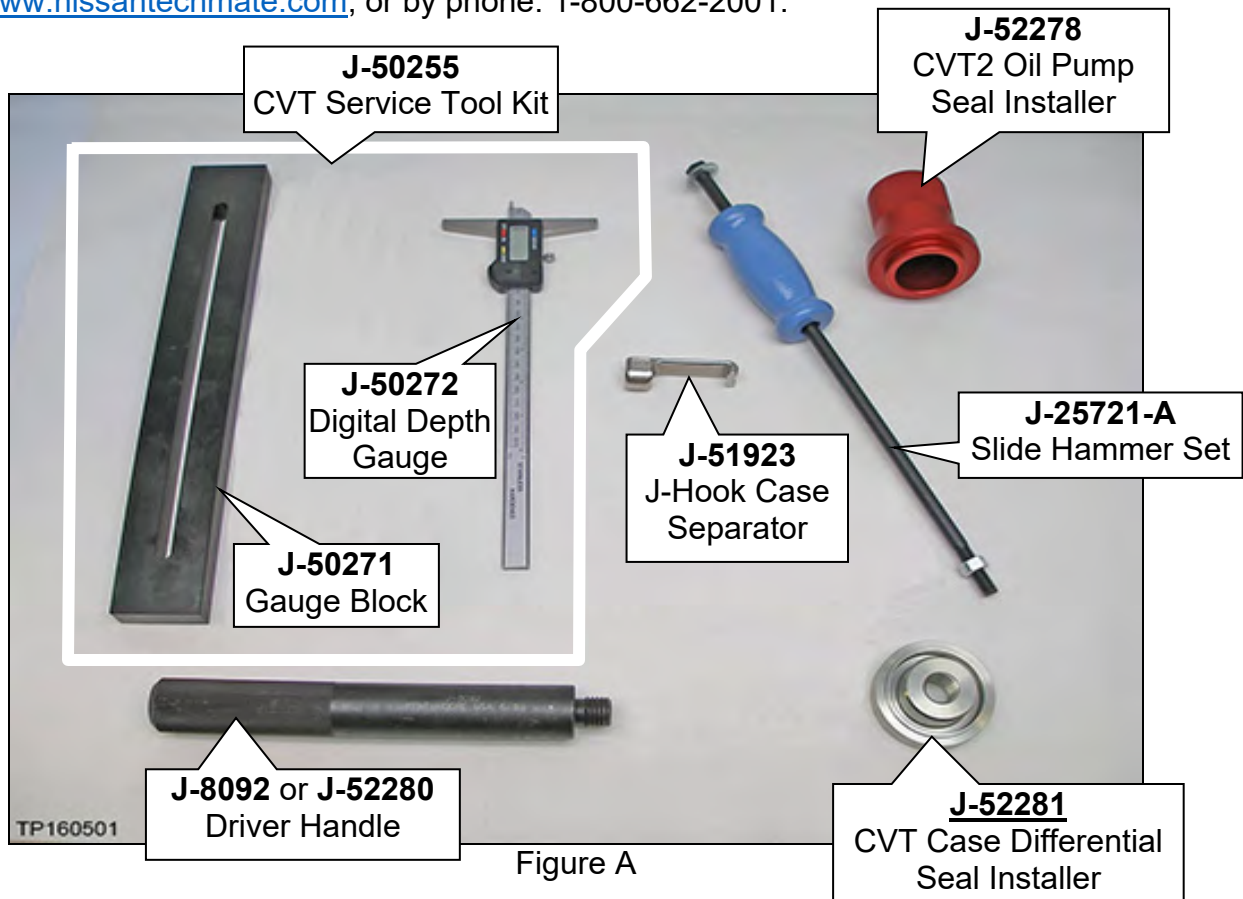

**J-52272** Assembly Guide Pins, Pulley Bracket

# Essential Special Service Tools (continued)

## Tech Cam J-51951

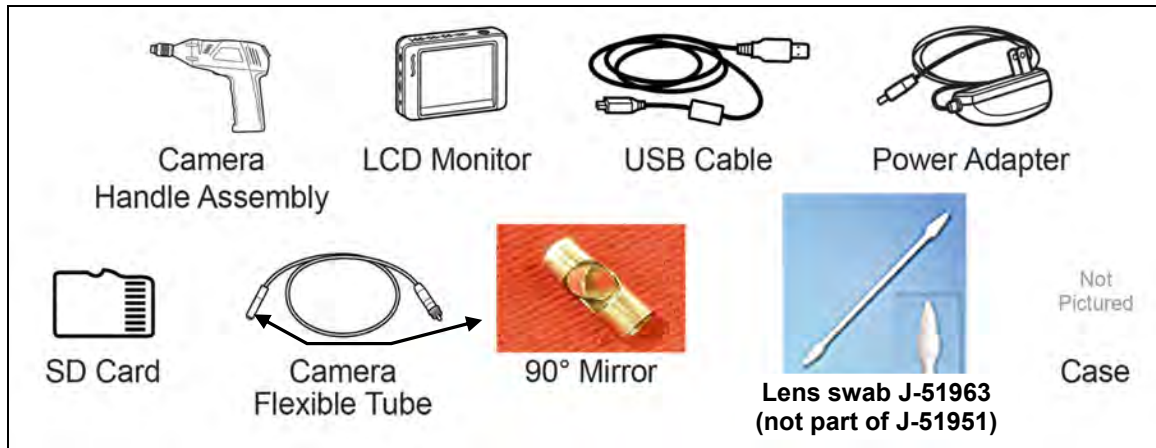

Figure C

**J-52306-1 and J-52306-2**  
Transmission Range Switch  
Alignment Bracket and Pin

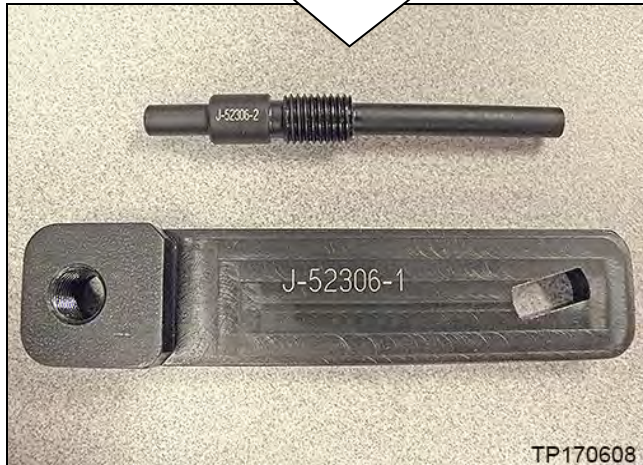

Figure D

**Clutch Engagement  
Tool J-52273**



Figure E

**Evap Pressure Test  
Kit J-42909**

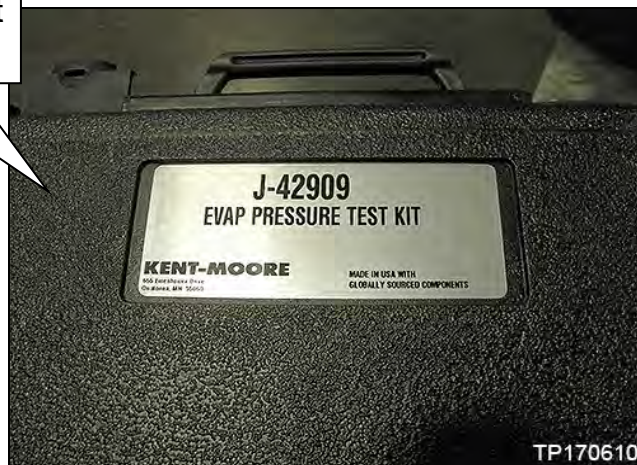

Figure F

**Essential Special Service Tools (continued)**

- Split Ring Seal Installer Kit **J-52595**

Seal Driver  
**J-52595-3**



Figure G

Split Ring Seal Cover  
**J-52595-4**



Figure H

First Groove Seal Tool (Top)  
**J-52595-1**



Figure I

First Groove Seal Tool (Bottom)  
**J-52595-1**



Figure J

Second Groove Seal Tool (Top)  
**J-52595-2**



Figure K

Second Groove Seal Tool (Bottom)  
**J-52595-2**



Figure L

## SERVICE PROCEDURE

**IMPORTANT:** Repairs performed for this bulletin require CONSULT-III plus (C-III plus) Diagnostic result reporting function-Setting be turned ON and Diagnosis (All Systems) be performed. If not done, it may result in a repair being non-warrantable.

### Precautions when Disassembling a CVT Assembly

#### **IMPORTANT:**

Transmissions are vulnerable to particle contamination (dust, metal, lint, etc.).

When disassembling a CVT, make sure your work environment (shop, workbench, etc.), transmission area (sub-frame, oil pan, harness connector, etc.), and your hands are free of any contamination.

It is essential that any foreign contamination be kept out of the CVT internals. Disassembly and re-assembly shall be carried out under the following conditions:

- Wash and clean the exterior of the CVT assembly prior to disassembling.  
**CAUTION:** Cover all air breather and drive shaft holes to prevent water intrusion.
- Work in a covered indoor room to prevent contamination of the CVT.
- Work on clean stainless drain table.
- Avoid debris from dropping into the converter housing, side cover or CVT case.
- Remove any sealant remaining on bolts or mating surfaces of the converter housing, side cover and/or the CVT case using a scraper, and then clean with lint-free paper cloths.
- Store removed parts separately to prevent mix-up. (i.e. small cups)
- Do not use cotton gloves or woven cloths. Latex or rubber gloves are recommended.
  - Only lint-free paper cloths.
- Apply rust penetrant to locator / dowel pins on torque converter housing and side cover of CVT and allow to soak as needed.
- Only disassemble those parts which are mentioned in this bulletin.
- Make sure all parts are clean prior to assembling / installing.
  - Brake cleaner is acceptable to remove remaining CVT fluid and residual sealer.
  - Unpack service parts just before installation.
- Use only specified sealant material.

**CAUTION: Non-warrantable damage to the CVT may occur if the steps in this procedure are not followed in order.**

### Inspect for Abnormal Noise

**NOTE:** If DTCs are stored, abnormal noise may be present.

1. Listen for any abnormal CVT noises under the following conditions:

Set the parking brake, start the engine, and then,

- If an abnormal CVT noise stops once the CVT is shifted into drive or reverse, this bulletin does not apply.
  - Refer to ASIST for further diagnostic information.
- If an abnormal CVT noise occurs while the CVT is in Drive (D) or reverse (R), proceed to **Control Valve (Valve Body) Removal** on the next page.

## Control Valve (Valve Body) Removal

### CAUTION:

- Never allow any chemicals or fluids other than NS-3 CVT fluid or suitable cleaners to enter the CVT assembly.
- Never allow any foreign debris, dust, dirt, etc. to enter the CVT assembly.

1. Write down all audio presets.

Presets	1	2	3	4	5	6
AM						
FM 1						
FM 2						
SAT 1						
SAT 2/3						
Bass	Treble		Balance	Fade	Speed Sen. Vol.	

2. Place the vehicle on a lift.

3. Before lifting the vehicle, place the transmission gear selector in Neutral.

4. Disconnect both battery cables, negative cable first.

5. Raise the vehicle, and then drain the CVT fluid by removing the drain plug.

- Remove engine under cover if needed.

**WARNING:** Use caution when looking into the drain hole as there is the risk of fluid entering the eye.

6. Disconnect the engine room harness from the CVT.

7. Remove the drain plug gasket from the drain plug.

- Discard the removed drain plug gasket (non-reusable).
- Replace drain plug gasket with a new one listed in the Parts Information.

8. Remove the oil pan mounting bolts, and then remove the oil pan and oil pan gasket.

- Do not discard bolts. These will be reused during assembly.



Figure 1B



## Exploded View

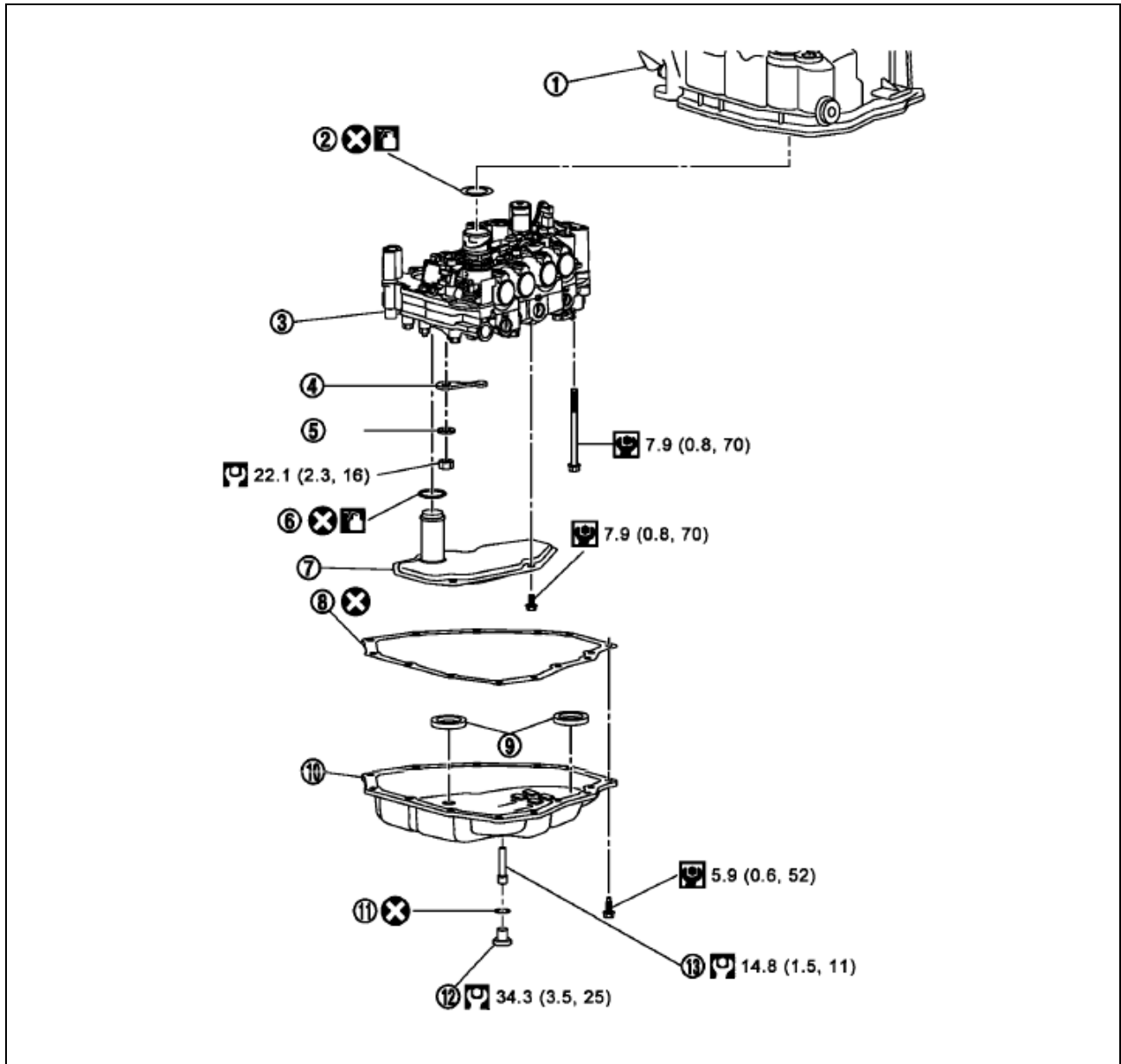



Figure 2B

- 1. Transaxle assembly
- 4. Manual plate
- 7. Strainer
- 10. Oil pan
- 13. Overflow tube

- 2. O-ring
- 5. Washer
- 8. Oil pan gasket
- 11. Drain plug gasket

- 3. Control valve
- 6. O-ring
- 9. Magnet
- 12. Drain plug

 : Always replace after every disassembly.

 : N•m (kg-m, ft-lb)

 : N•m (kg-m, in-lb)

9. Inspect inside the CVT pan for any evidence of broken parts.

**EXAMPLE:**

- Figure **3B is acceptable for this repair** – Magnets with fine debris or sludge in any amount.
- Figure **4B is No Good (NG) for this repair** - Broken parts would include pieces of bearing cages, bearings, clutch material, belt elements, etc.

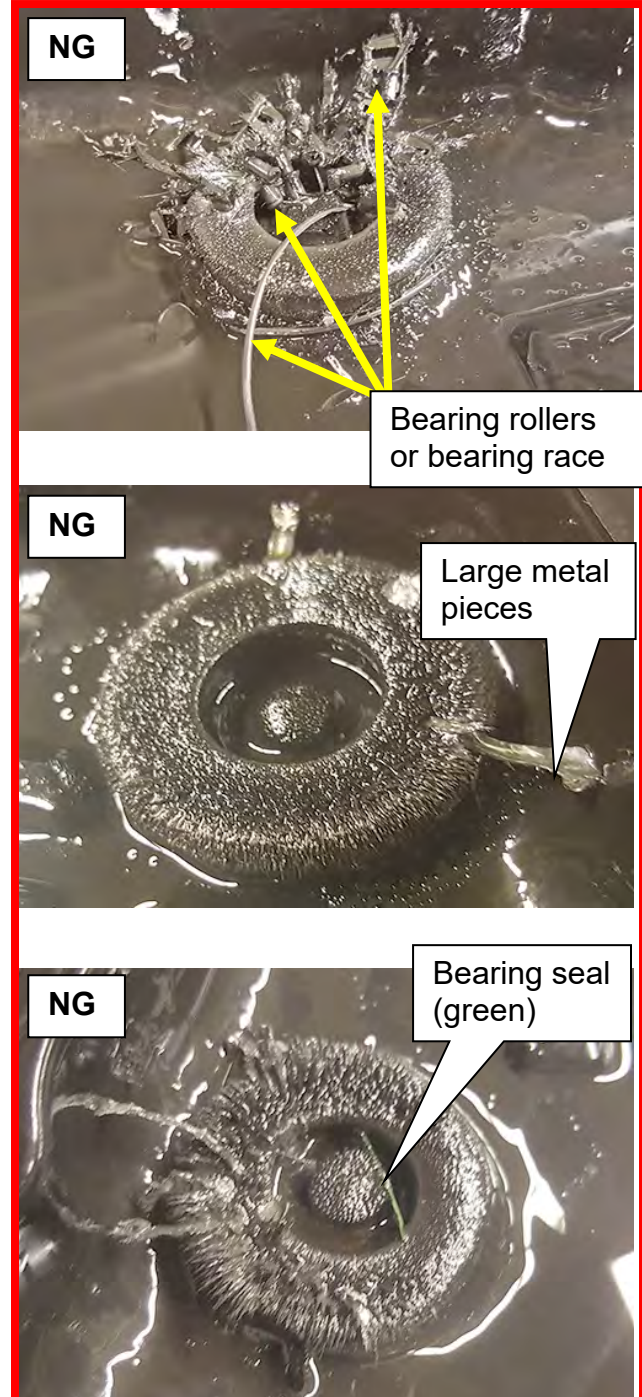

Figure 4B

Proceed to the next page.

- Is there any evidence of broken parts or excessive debris?
  - **YES:** Replace the CVT assembly as follows:
    - a. Document the debris found with video (see page 137 for details).
    - b. Re-install the CVT oil pan gasket and oil pan.
    - c. Call the PCC for CVT replacement authorization (see page 137 for contact information).
    - d. Refer to the Electronic Service Manual (ESM), section TM – Transaxle & Transmission for CVT replacement.
  - **NO:**
    - If DTC P17F0 is not stored, proceed to next step to continue the repair.
    - If DTC P17F0 is stored, proceed to **Remove CVT from the Vehicle and Disassemble External Parts** on page 25.

10. Remove the magnets from the oil pan.

**NOTE:** The CVT pan may come with two (2) or three (3) magnets.

- Clean the magnets.
- Clean the CVT oil pan.
- Reinstall the magnets to the oil pan in their original positions.

11. Remove the three (3) strainer bolts, and then remove the strainer from the valve body.

- These bolts will be reused.

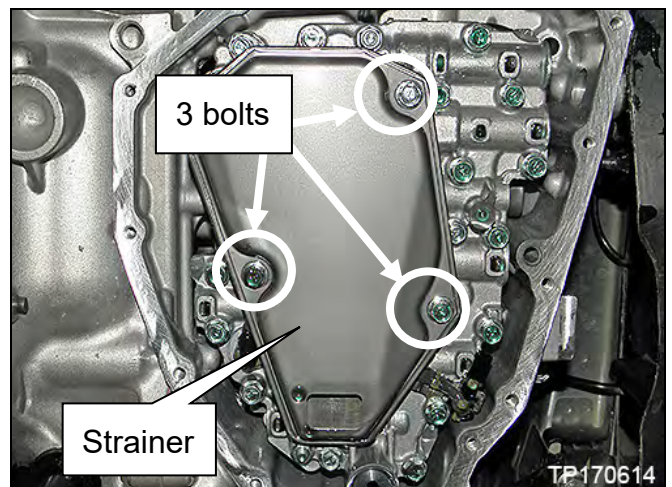

Figure 5B

12. Remove the nut and washer, and then remove the manual plate shown in Figure 6B.

- Use a screwdriver to hold the manual plate (Figure 7B) to keep the shaft from rotating while removing the nut.
- Do not discard nut and washer. These will be reused during assembly.

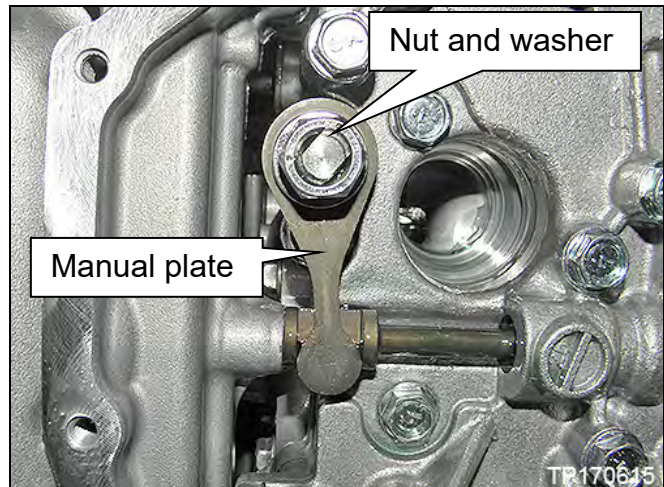

Figure 6B

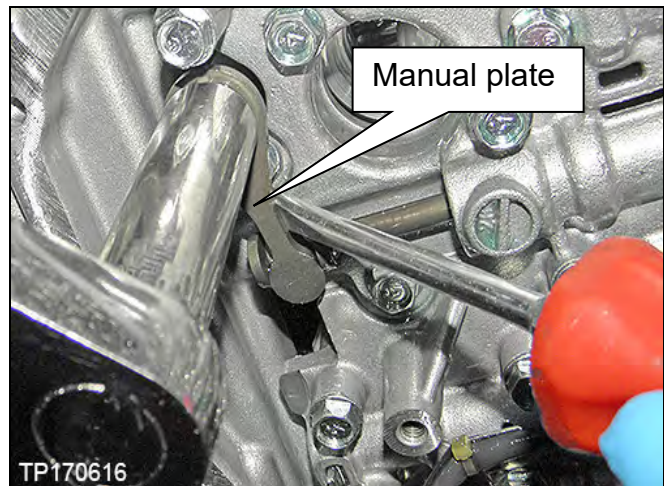

Figure 7B

13. Clean around the CVT unit harness connector to prevent foreign materials from entering into the CVT case.

14. Remove ONLY the eleven (11) valve body bolts with markings as shown in Figure 8B.

- Do NOT remove the bolts with a single dot over the "7".
- The bolts removed will be reused.

15. Press the CVT unit harness connector down into the transaxle case, and then remove the valve body from the transaxle case.

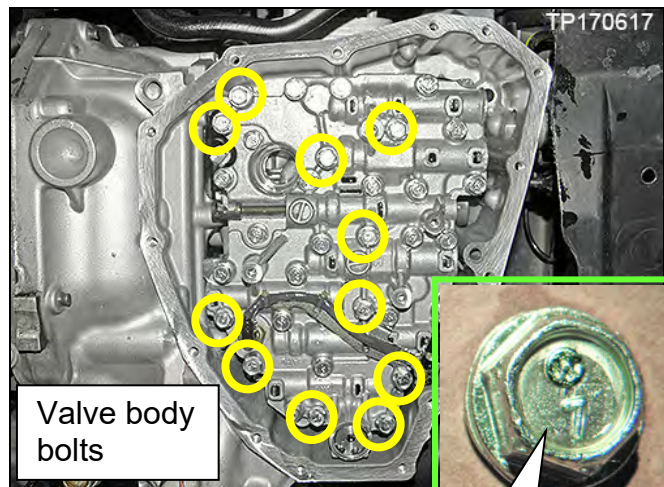

Figure 8B



Correct bolt

**CAUTION:** Do not damage the CVT unit harness connector.

## CVT Belt Visual Inspection

1. Secure the front right tire with a suitable strap.
  - This will assist in making the belt turn during the borescope belt inspection step.
2. Mark the front left tire with a suitable marking.
  - This will assure all 360° of the belt is inspected.



Figure 1C

3. Using the steps on pages 14-19 inspect the entirety of the two sides of the belt that come in contact with the pulleys (see Figure 2C).

### IMPORTANT:

- Reference the pictures on pages 20-23 for comparison.
- Use borescope J-51951 with mirror attachment.
- Be sure to remove the protective film from the mirror before the first use.
- Clean the camera lens and mirror before each inspection. Use 90% isopropyl alcohol, and a lens swab from Lens Swab packet J-51963 listed in PARTS INFORMATION.
- Before inspecting, make sure the camera handle's AA batteries are fresh and the LCD monitor's battery is charged.

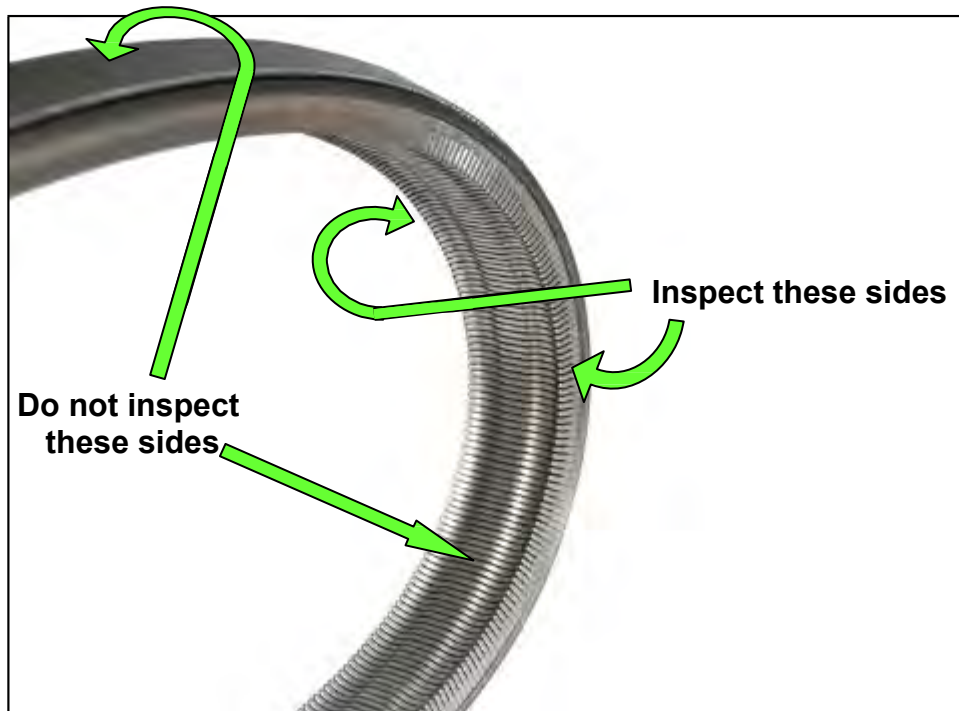

Figure 2C: New belt

a. Install the Clutch Engagement Tool (J-52273) to the CVT case with two bolts where shown in Figure 3C finger tight.

- Bolt torque not to exceed: 2.26 N•m (0.23 kg-m, **20 in-lb.**)

**CAUTION:**

- Do not over torque the bolts. The threads are easily damaged.
- Make sure an O-ring is installed to the Clutch Engagement Tool (J-52273) before installation.

**NOTE:** The O-ring for the Clutch Engagement Tool comes with the attachment. To obtain only the O-ring, refer to Parts Information for the part number.

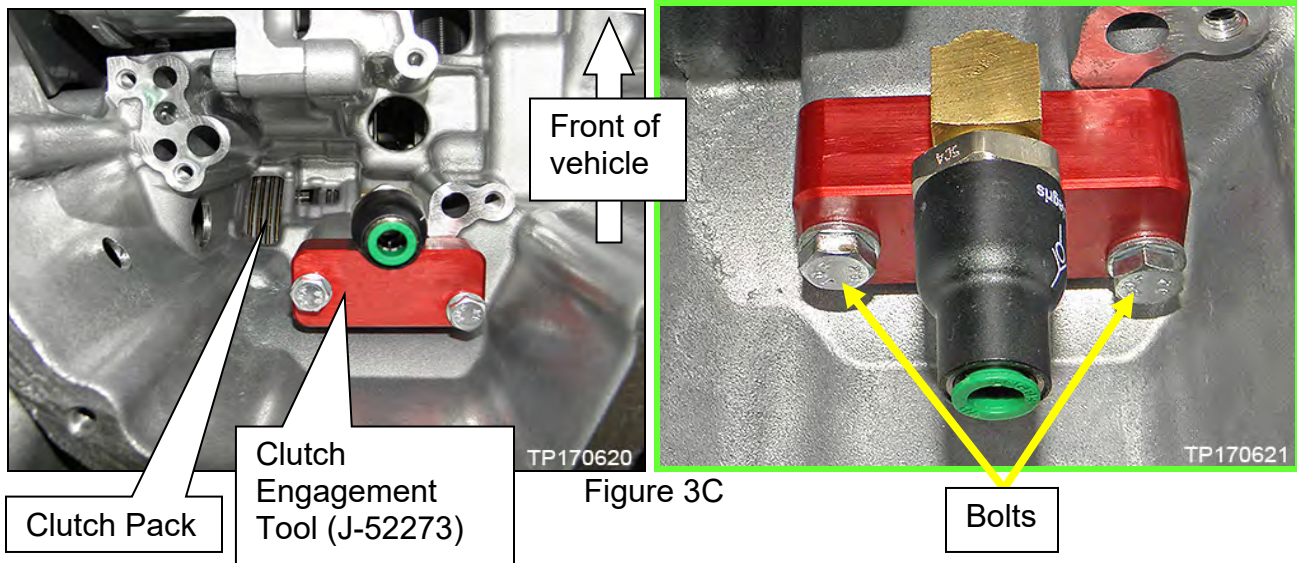

b. Connect the Hand pump from Evap Pressure Test Kit (J-42909) to the Clutch Engagement Tool (J-52273) and pump to 20 PSI.

**IMPORTANT:**

- Proper pressure has been achieved when the CVT belt moves while the left front wheel is rotated and the vehicle is in NEUTRAL with the right front wheel secured.
- Do NOT over pressurize the system as internal damage to the CVT could result.
- Hand pump should be removed from the Clutch Engagement Tool (J-52273) quick connect once the clutch has been engaged and the belt is observed moving with tire rotation.
  - Pressure will be retained.

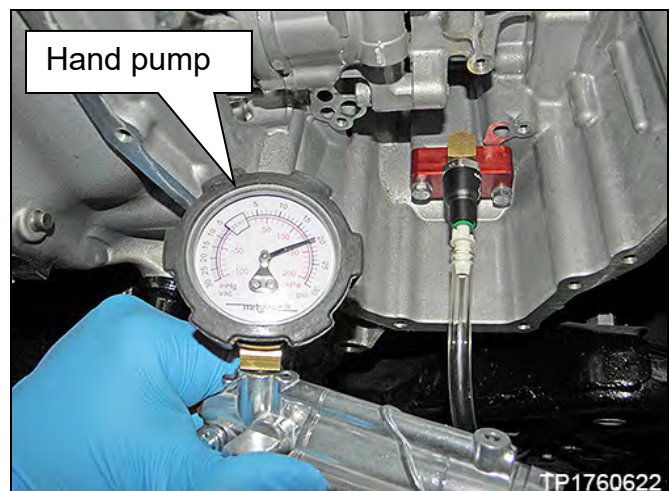

c. Insert the borescope where shown in Figure 5C as follows:

- I. Face the mirror of the borescope toward the driver's side of the vehicle (CVT side cover).
- II. Insert the lens approximately 7.5 inches from the CVT oil pan gasket surface as shown in Figure 6C on page 16.
- III. And then view the side of the belt that contacts the pulley.

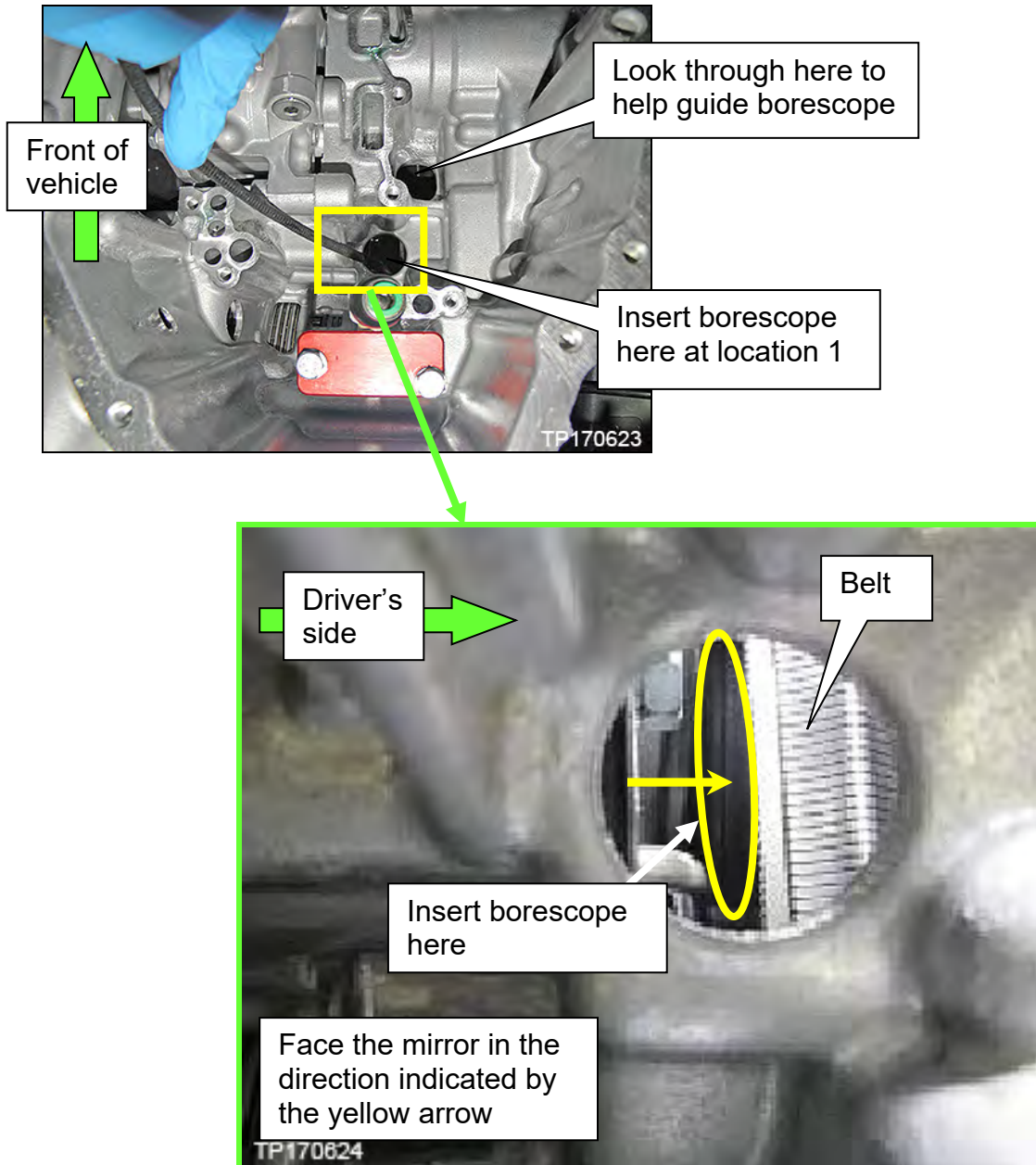

Figure 5C

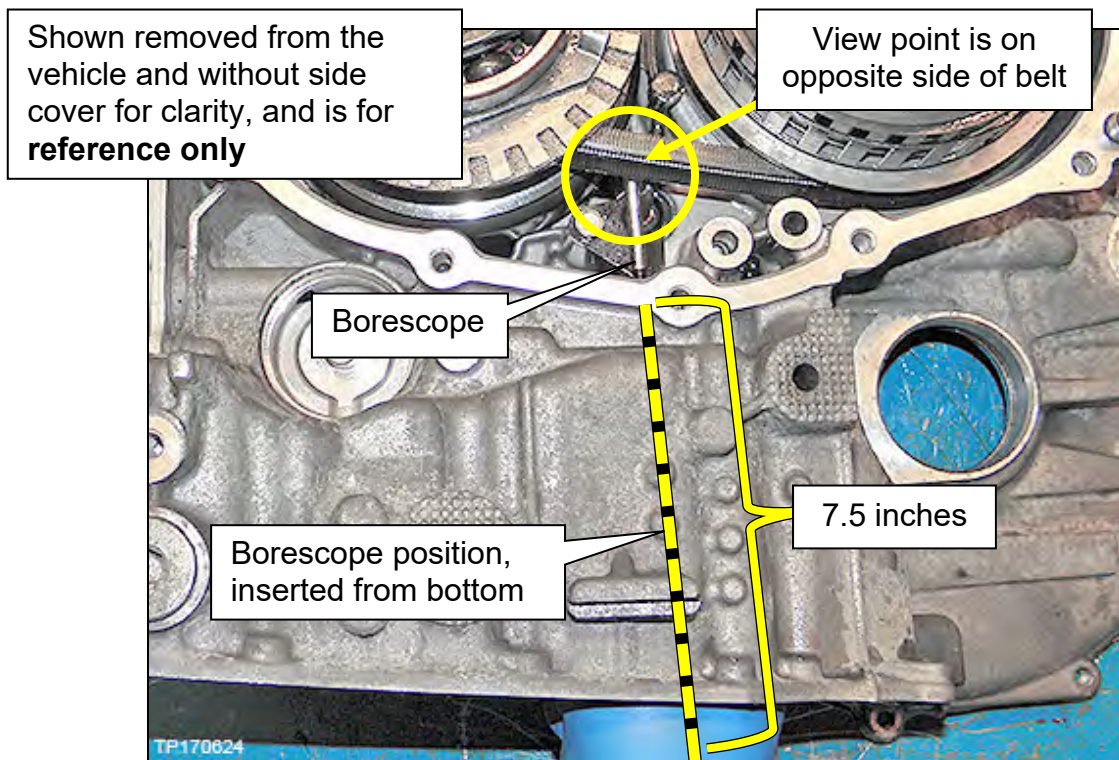

Figure 6C

d. Using the mark applied to the left front tire for reference, slowly and carefully rotate the front left tire one full turn in either direction to view all of the belt.

- Holding the borescope (camera flexible tube) with one hand allows rotation of the tire with the other hand (see Figure 7C).
- If evidence of belt slip is identified as shown on pages 20-23, skip to step 5 on page 24.
- If the belt does not move when rotating the front left tire, return to step 3b on page 14.



Figure 7C

- e. If the inspection result confirms that no slippage has occurred on the observed side, inspect the other side of the belt as follows:
- I. Print page 17 and then shape the borescope camera flexible tube like the image in Figure 8C.



For the following steps print this page as a template to adjust the borescope camera flexible tube to match.

- Do not shrink or enlarge sheet size when printing.

Figure 8C: Template for borescope camera flexible tube is shown actual size.

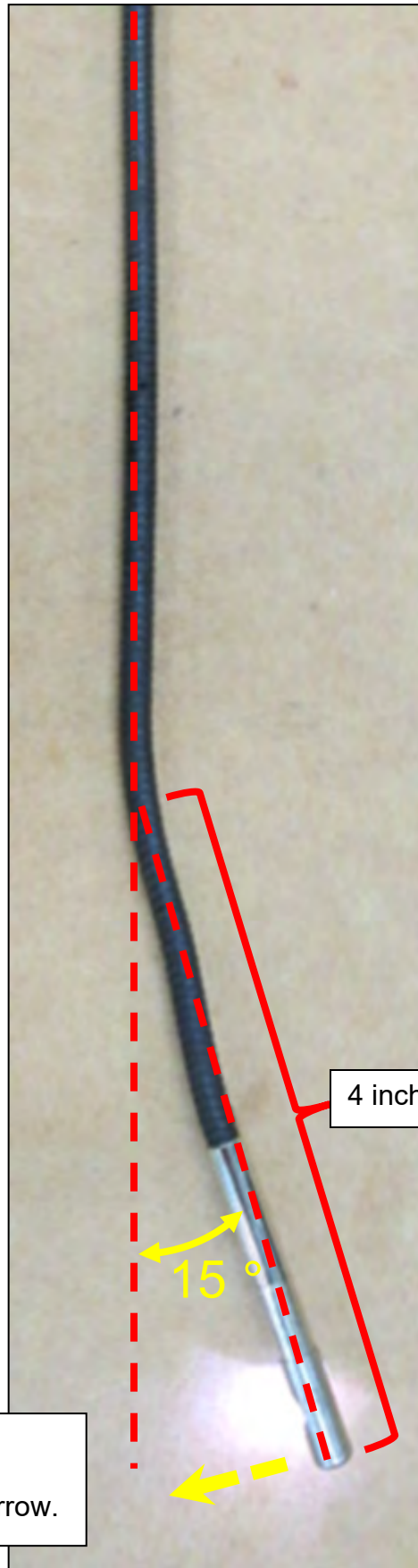

The figure is 9 inches long

4 inches

15°

**Camera view**

- Face the mirror in the direction of the yellow arrow.

Figure 8C

- II. Face the mirror of the borescope toward passenger side (Engine side).
- III. Insert the borescope in the second location where shown in Figure 9C.
- IV. Insert the lens approximately 8.7 inches from the CVT case rim as shown in Figure 10C on the next page.
- V. And then view the side of the belt that contacts the pulley.

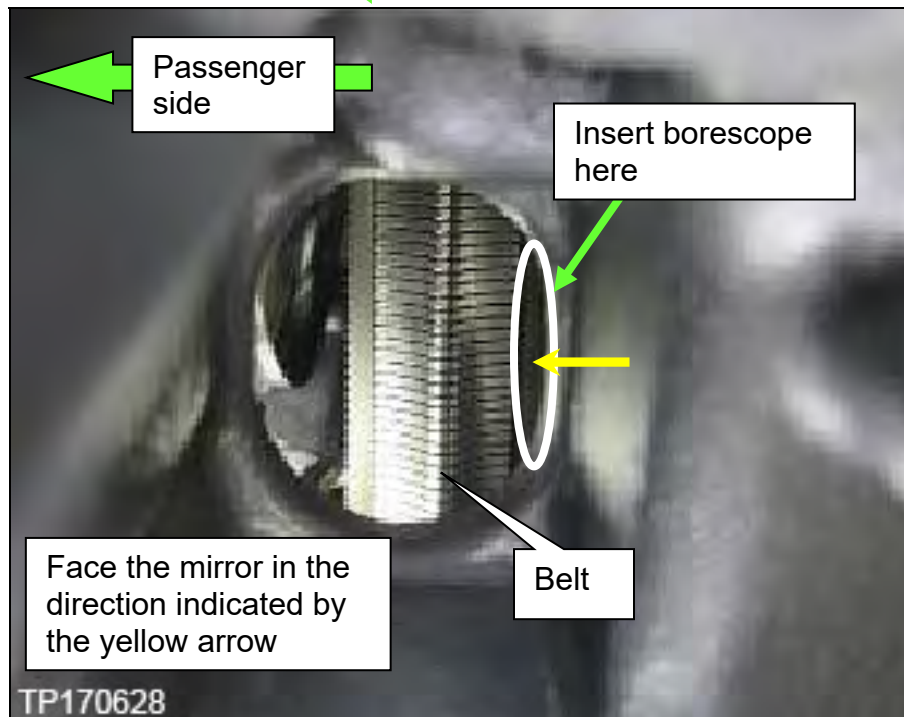
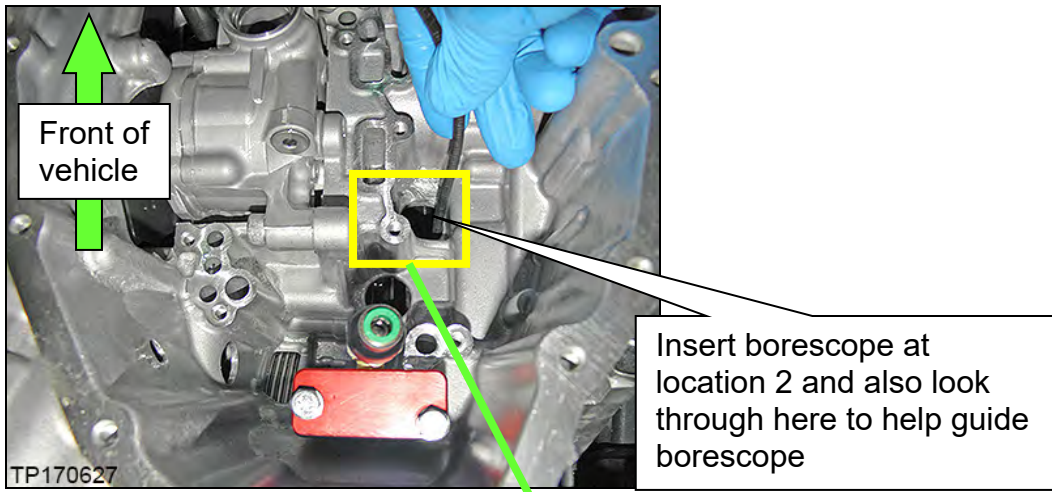

Figure 9C

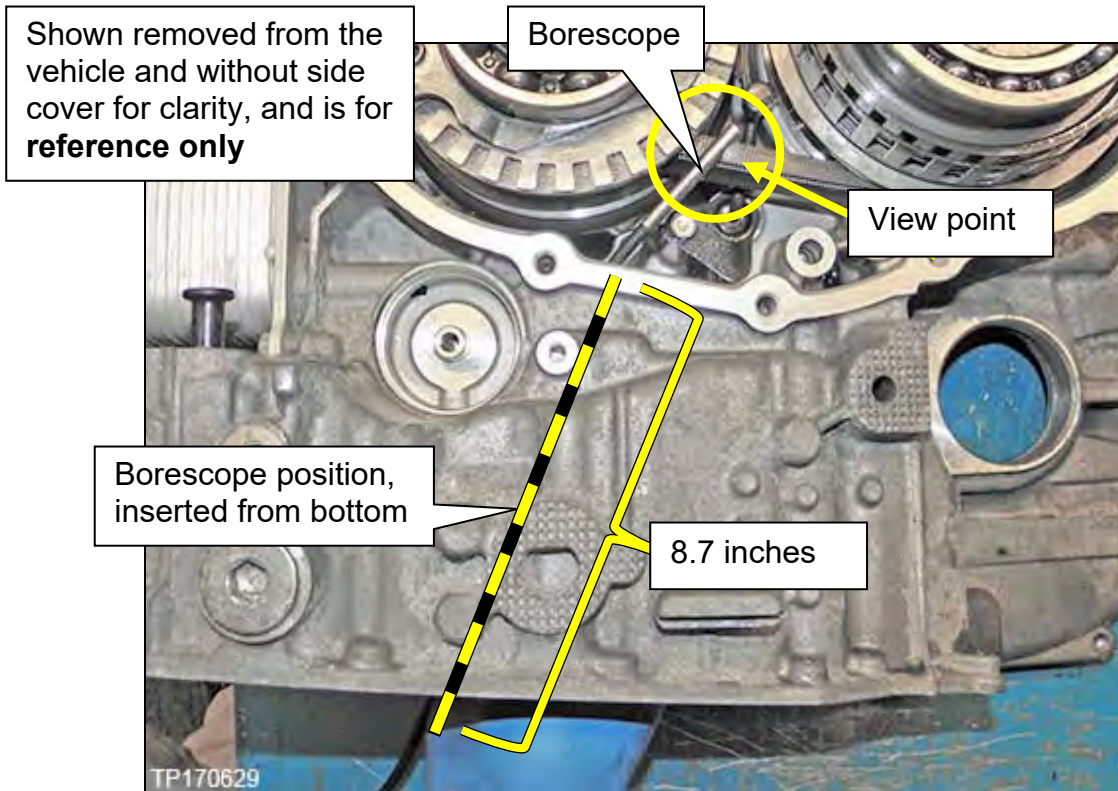

Figure 10C

- f. Using the mark applied to the left front tire for reference, slowly and carefully rotate the front left tire one full turn in either direction to view all of the belt.
- Holding the borescope (camera flexible tube) with one hand allows rotation of the tire with the other hand (see Figure 7C).
- IMPORTANT:** If the belt does not move when rotating the front left tire, supply additional air with hand pump (J-45664) to re-engage the clutch as necessary.
- Look for evidence of belt slip as shown on pages 20-23.
- g. Remove the Clutch Engagement Tool (J-52273) from the CVT.
- CAUTION:** The remaining CVT fluid may spray when the Clutch Engagement Tool is removed. Place a rag over the Clutch Engagement tool and SLOWLY loosen the two bolts until the audible depressurization is noted.
- h. Is the inspection result OK (no evidence of slip) for 360° rotation of both sides of the belt?
- YES:** Go to step 4 on page 24 (No Belt Damage).
- NO:** Go to step 5 on page 24 (Belt Damaged).

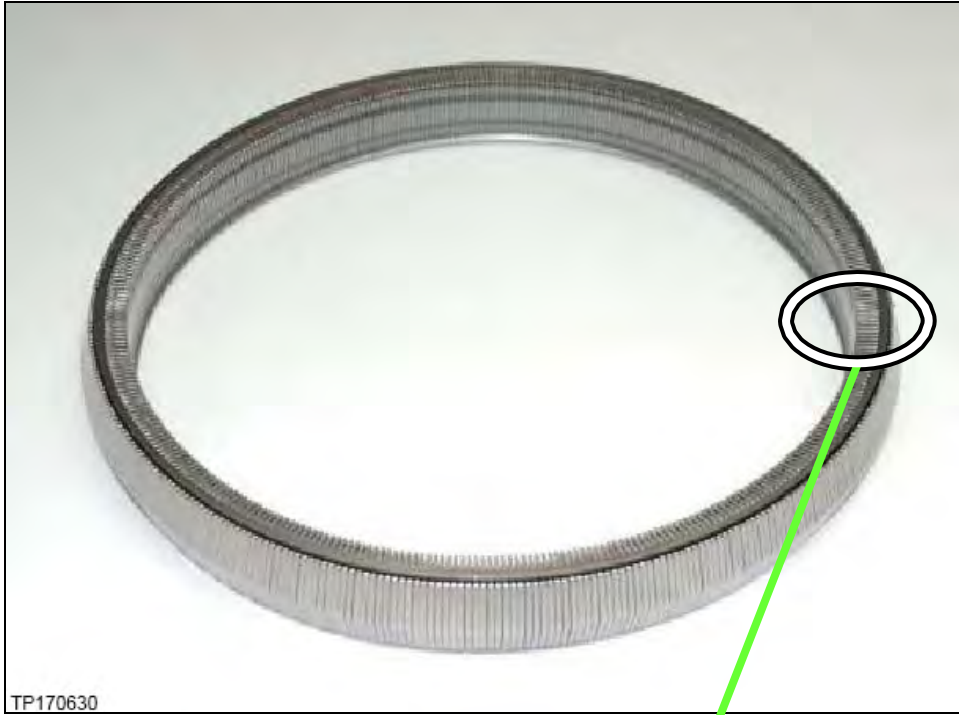

Figure 11C New belt

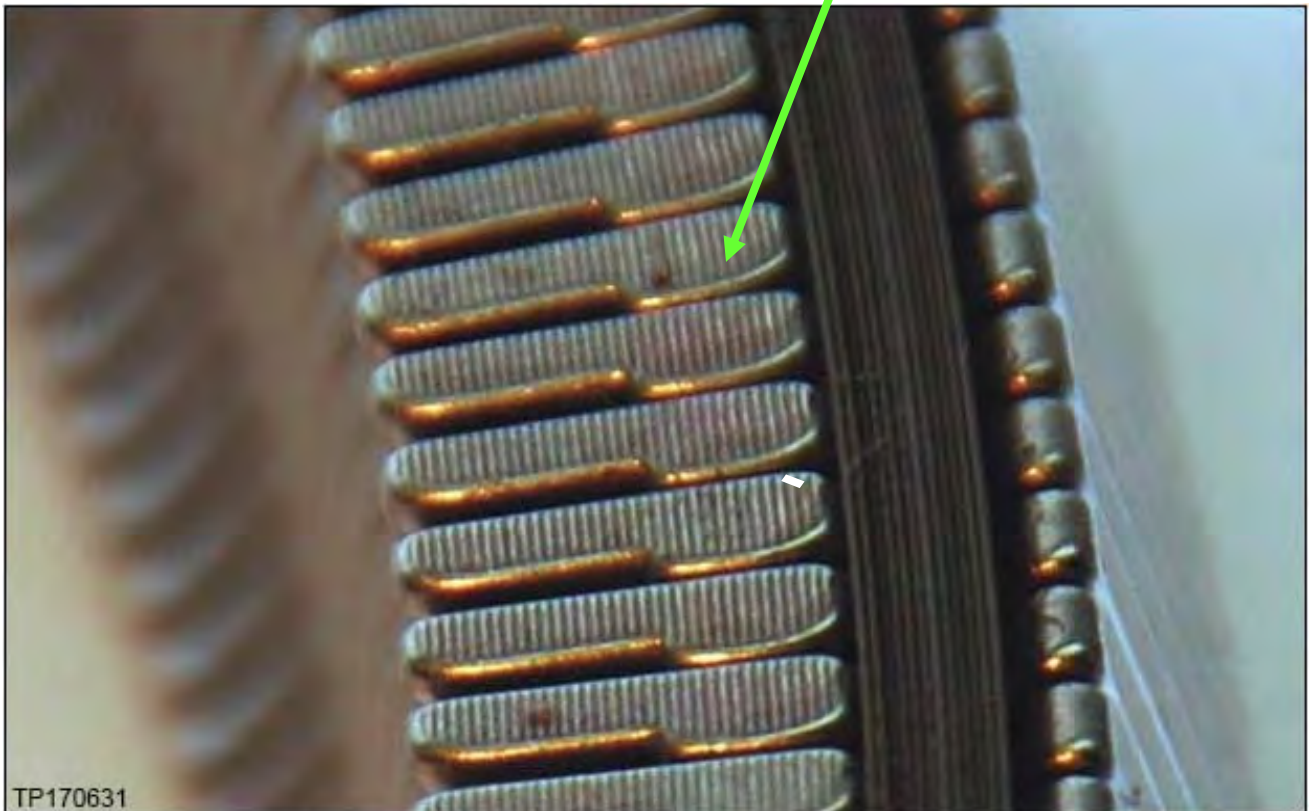

Figure 12C: Close-up of section to be inspected

Pictures in Figure 13C and 14C were taken with borescope J-51951.

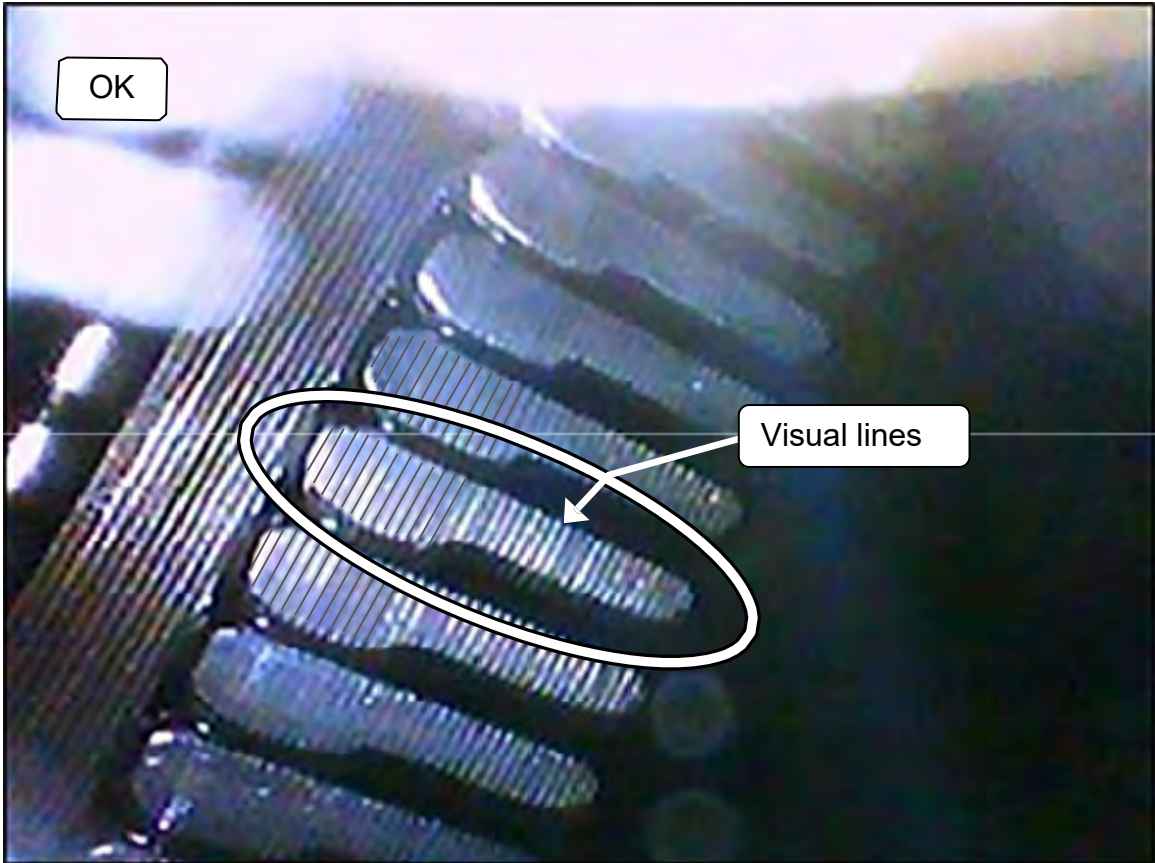

Figure 13C: Belt is OK

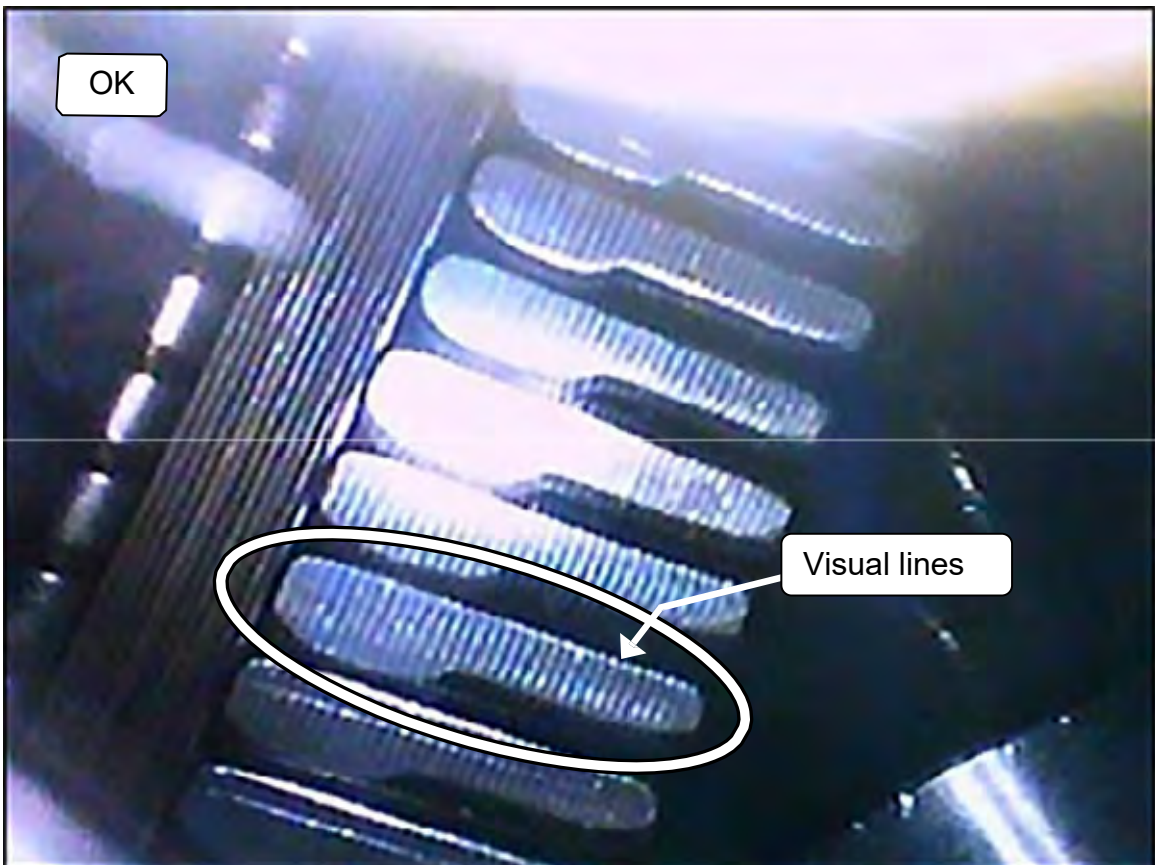

Figure 14C: Belt is OK

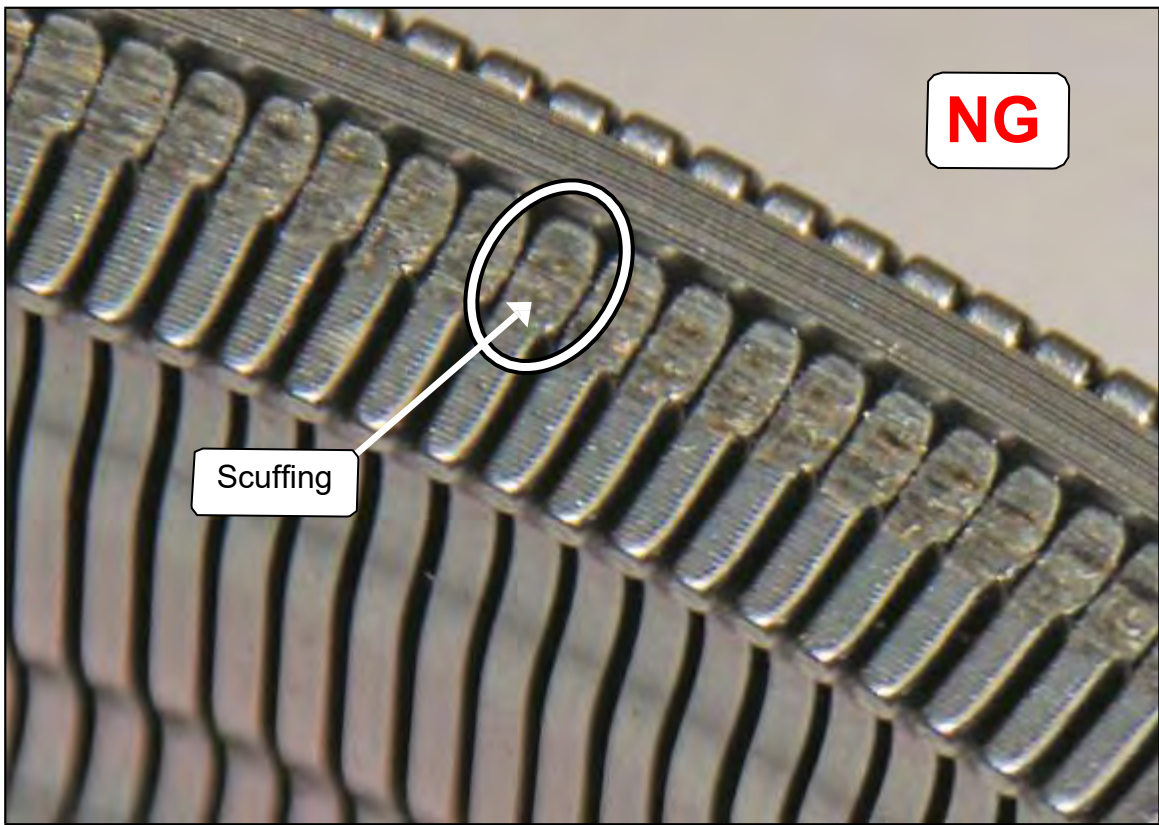

Figure 15C: Example of NG belt

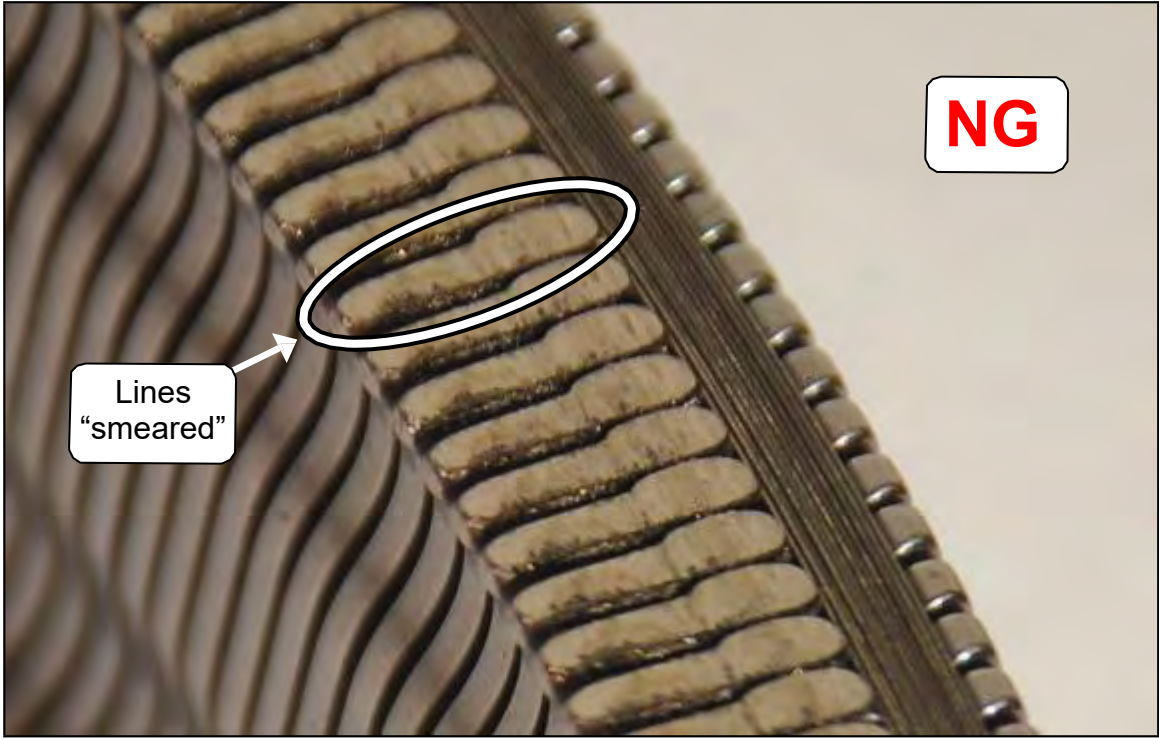

Figure 16C: Example of NG belt

Pictures in Figure 17C-19C were taken with borescope J-51951



Figure 17C: Example of NG belt

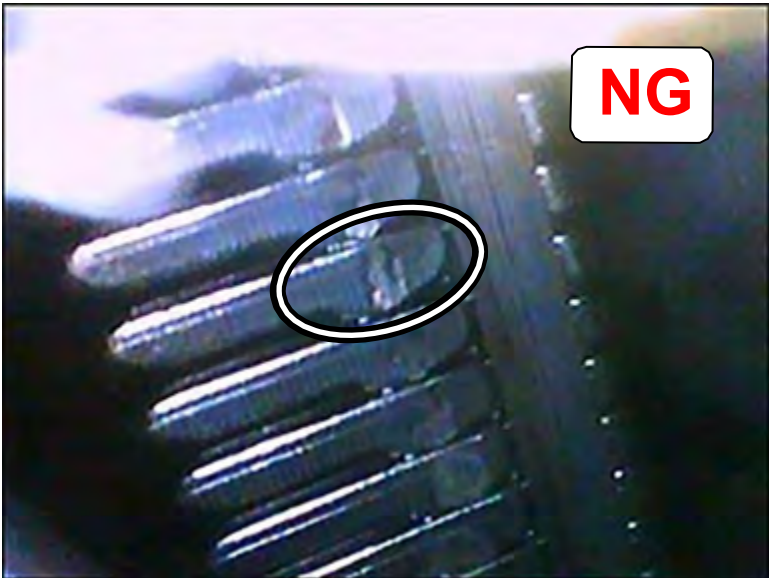

Figure 18C: Example of NG belt

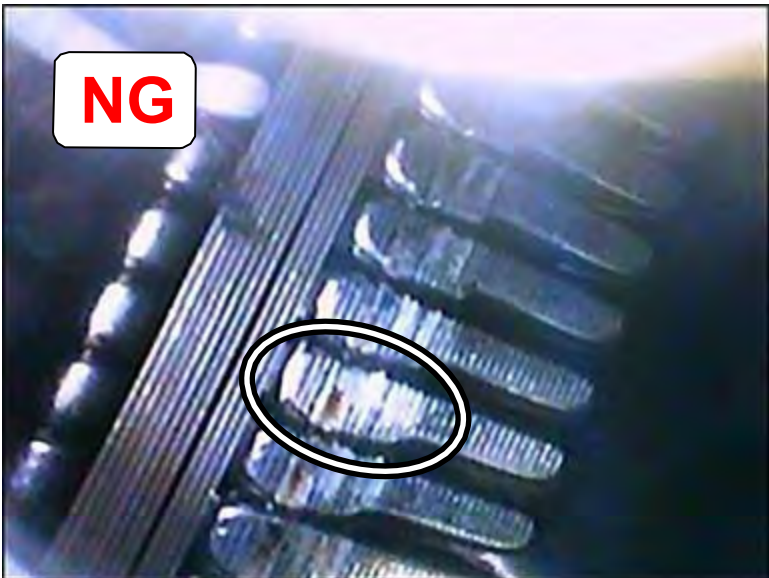

Figure 19C: Example of NG belt

## No Belt Damage – Only Valve Body is Replaced

4. Install a new valve body in the reverse order of disassembly:
  - Refer to **Install the Valve Body and Oil Pan** on page 83.

And then,

- a. Connect both battery cables, negative cable last.
- b. Reset/reinitialize systems as needed.
  - Refer to the ESM, section **PG – Power Supply & Ground Elements**, for a listing of systems that require reset/initialization after reconnecting the 12V battery.
  - Look in the PG section index for **ADDITIONAL SERVICE WHEN REMOVING BATTERY NEGATIVE TERMINAL**.
  - This list often includes items such as radio, power windows, clock, sunroof, etc.

### IMPORTANT:

- c. Perform **ADDITIONAL SERVICE REQUIRED** starting on page 97.

## Belt Damaged

5. Install the original (removed) oil pan gasket and oil pan temporarily with at least two oil pan bolts, hand tight.

**IMPORTANT:** DO NOT discard the remaining oil pan bolts. These bolts will be re-used.



Figure 20C

6. Replace the belt and pulley sub-assembly and valve body.
  - Go to **Remove CVT from the Vehicle and Disassemble External Parts** on the next page.



## Remove CVT from the Vehicle and Disassemble External Parts

1. Remove the CVT from the vehicle.
  - Refer to the ESM, section **TM – Transaxle & Transmission** for CVT removal.

2. Put the CVT assembly on a work bench with the oil pan side down.

**CAUTION:** Take care not to damage the oil pan.

3. Remove the torque converter.

- The torque converter will be reused during reassembly.

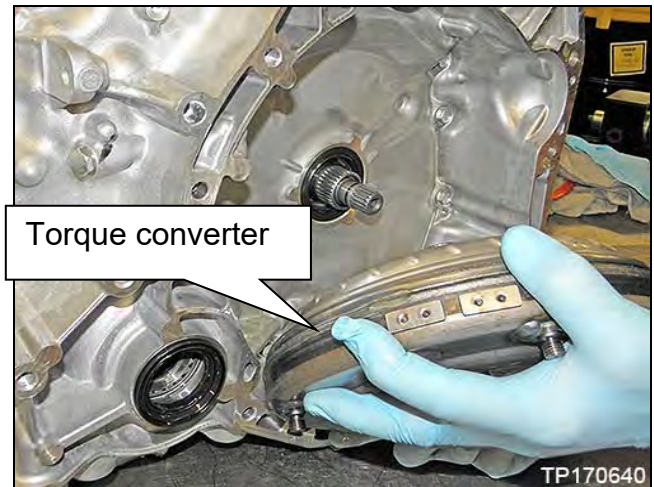

Figure 1D

4. Drain the CVT fluid out of the torque converter.



Figure 2D

5. Remove the output speed sensor, primary speed sensor and secondary speed sensor from the CVT (Figure 3D).
  - These sensors will be reused.
  - Inspect all three sensors for debris on the magnet and clean as necessary.
6. Remove the O-rings from all three speed sensors.
  - Discard the removed O-rings. These will be replaced during reassembly.

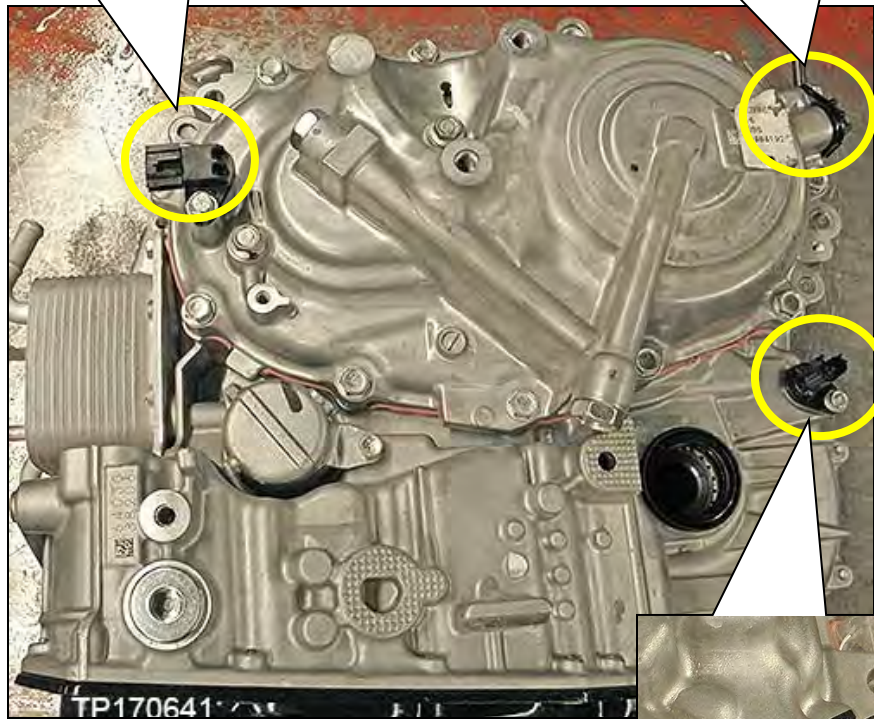
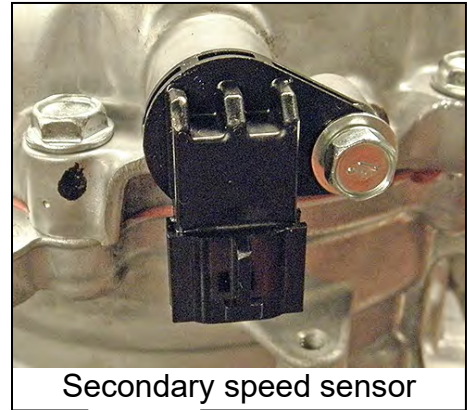
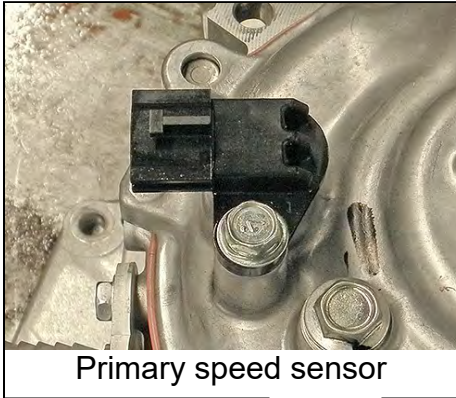
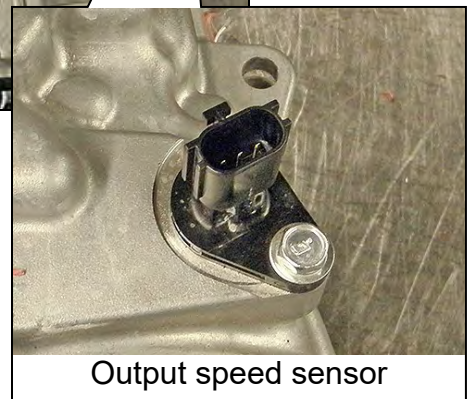

Figure 3D



## Remove the Oil Filter

1. Remove the oil filter from the CVT case as follows:

- a. Remove the oil filter cover bolt.
  - This bolt will be reused.

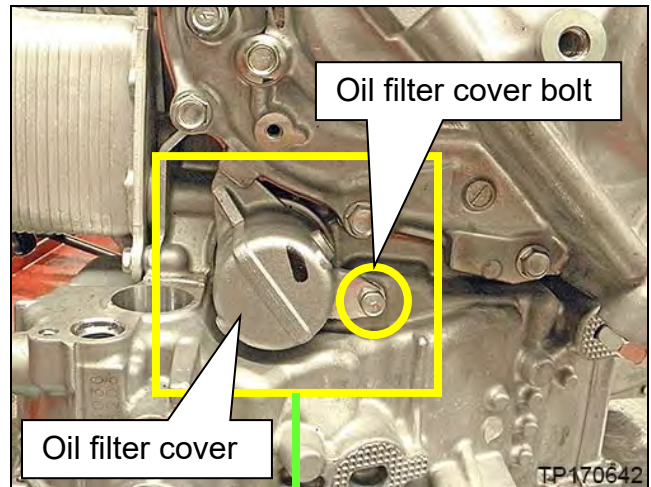

Figure 1E

- b. Rotate the oil filter cover counterclockwise approximately 15 degrees or until the cover clears the locking tab.
- c. Pull the oil filter cover away from the CVT case to remove.

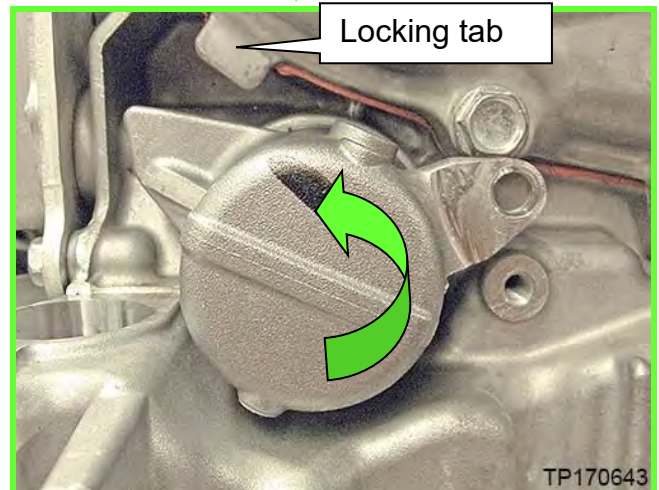

Figure 2E

2. Pull the oil filter with grommet away from the CVT case to remove.

- Discard the removed filter with grommet (non-reusable).

**NOTE:** Grommet may separate from the filter and remain on the CVT case.

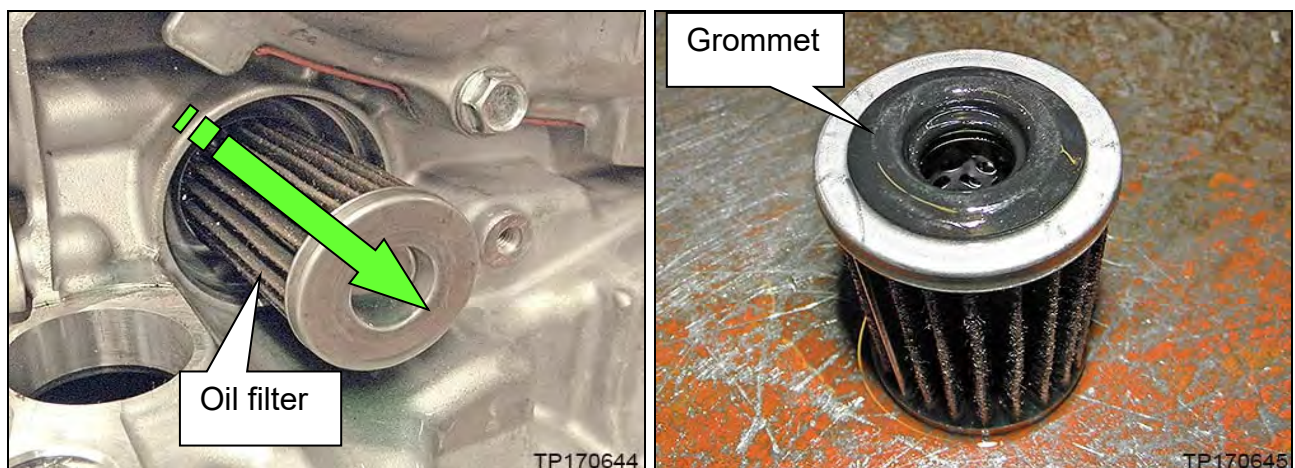

Figure 3E

3. Remove the O-ring from the oil filter cover.
  - Discard the removed O-ring (non-reusable).

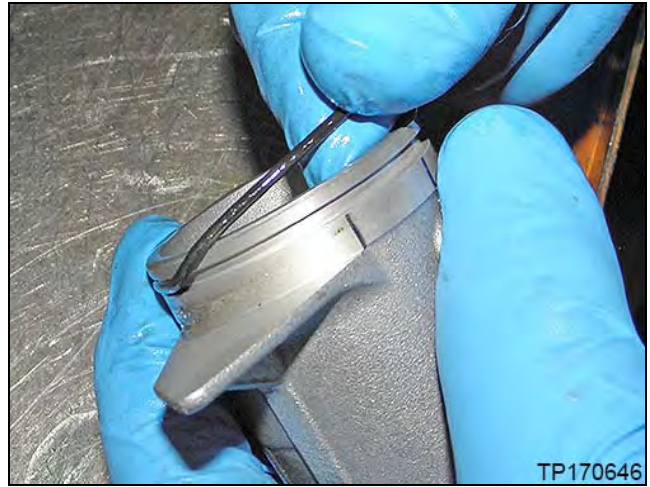

Figure 4E

4. Thoroughly wipe and clean the inside of the oil filter cover.
  - Brake cleaner may be used during this step to thoroughly remove any residual material.



Figure 5E

5. Thoroughly wipe and clean the filter bore (highlighted in green) of the CVT case.

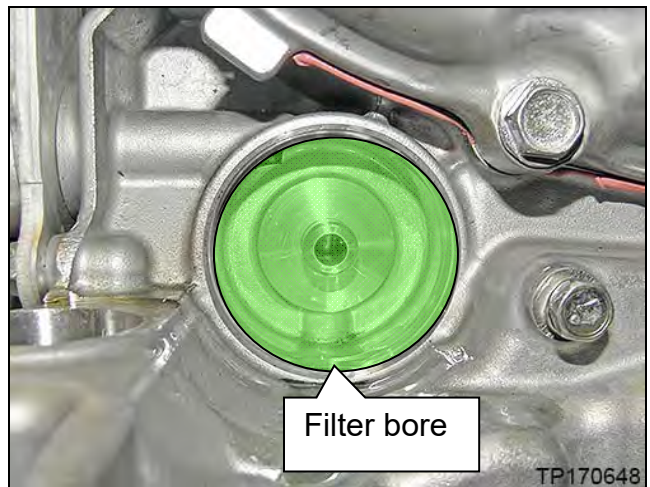

Figure 6E

## Remove the Oil Pan and Torque Converter Housing

1. Reposition the CVT assembly on the work bench with the torque converter housing side facing up.
  - Use plastic or wood blocks to stabilize the CVT assembly on the work bench if needed.

**NOTE:** CVT fluid will drain from the CVT case when the oil pan is removed.

2. Remove the oil pan and oil pan gasket which were installed to the CVT temporarily. **Bolts will be reused.**
  - Discard the removed oil pan gasket.
  - Keep the original oil pan for installation during reassembly.
3. Remove the nineteen (19) bolts shown in Figure 2F from the torque converter housing.
  - Do not discard these bolts. They will be temporarily re-used later in this procedure.

**NOTE:** Some bolts are not visible in Figure 2F. Yellow circles give the general area of bolt locations.
4. Remove the torque converter housing from the CVT case.
  - Use a Slide Hammer (J-25721-A) at the three locations shown in Figure 2F if needed.
  - The input shaft thrust bearing washer may be attached to the torque converter housing, remove it and put it aside; it will be reused.

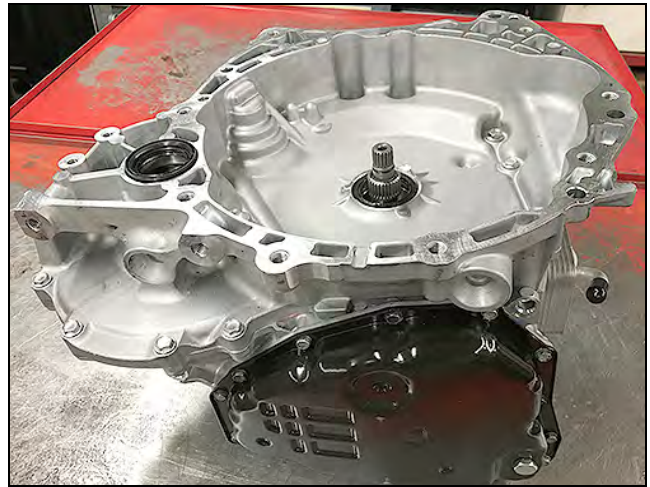

Figure 1F

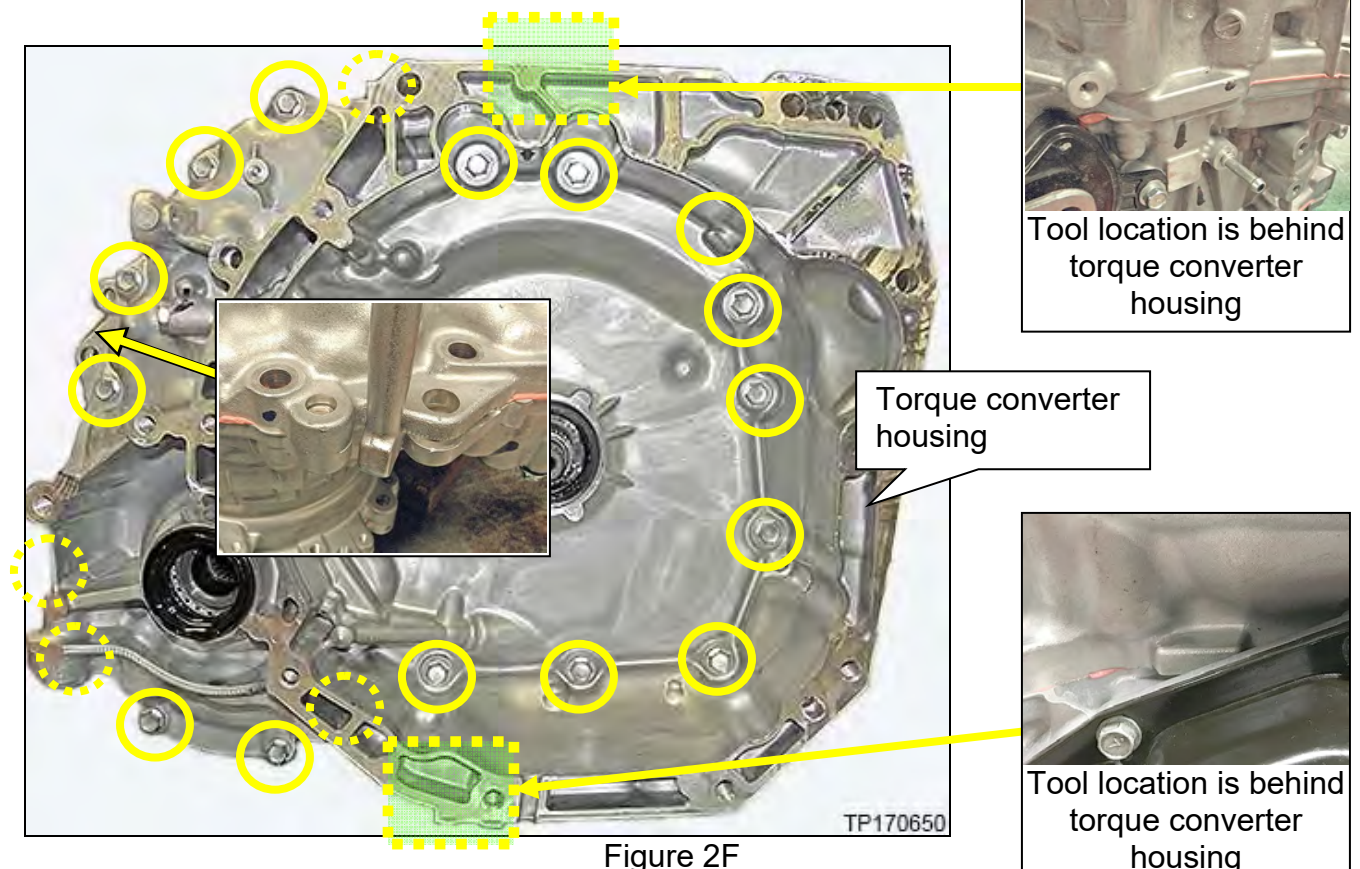

Figure 2F

## Remove the Oil Seals from the Torque Converter Housing

1. Remove the torque converter oil seal from the torque converter housing with a suitable tool.
  - Take care not to damage the seal-to-case surface when removing seal.
  - Discard the torque converter oil seal (non-reusable).
2. Remove the differential side oil seal from the torque converter housing with a suitable tool.
  - Discard the differential side oil seal (non-reusable).

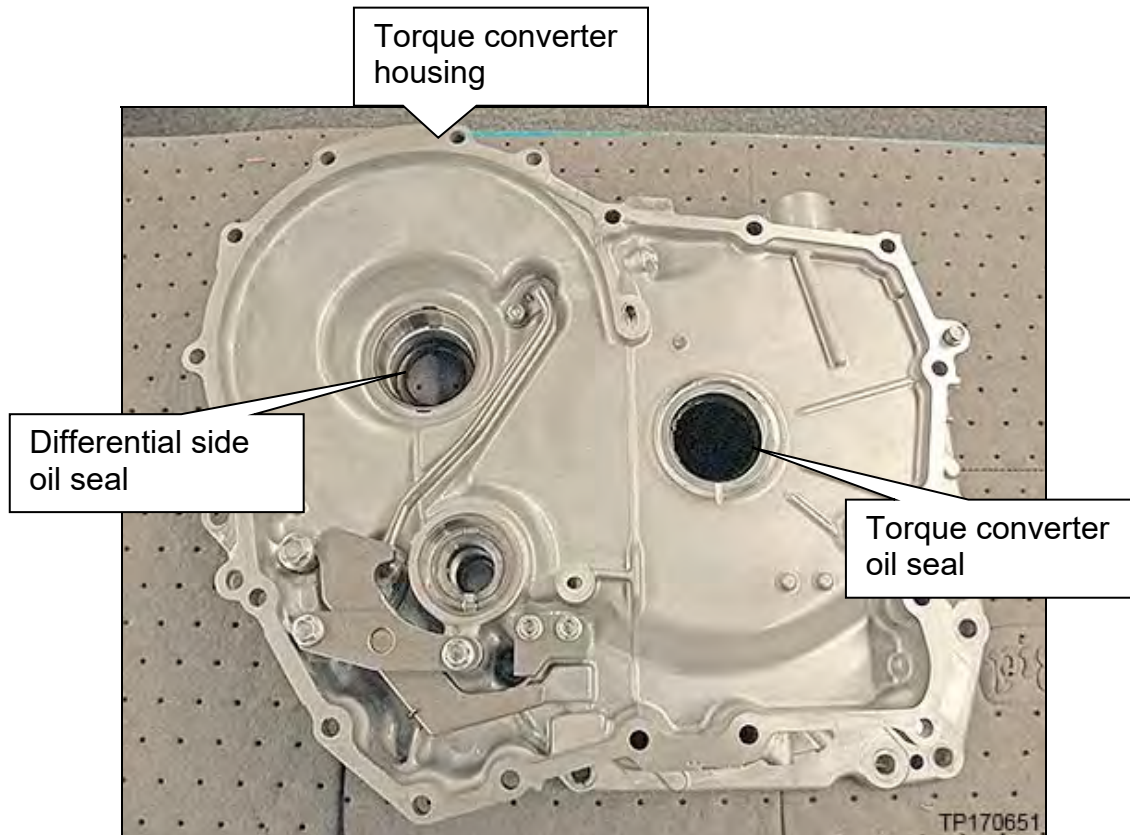

Figure 1G

## Remove the CVT Internal Components

1. Remove the final drive assembly and the reduction gear assembly at the same time by lifting both straight up.

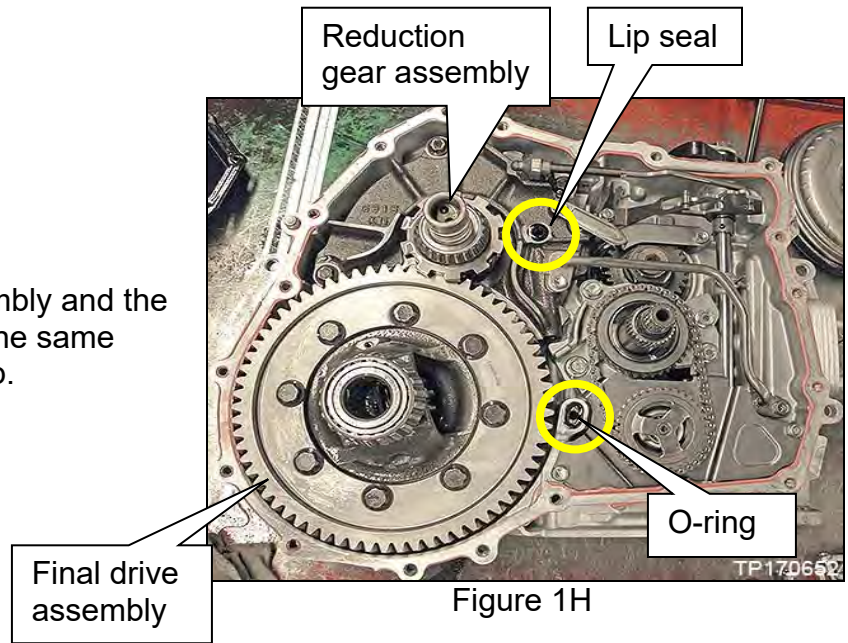

Figure 1H

2. Remove the lip seal from the CVT case.
  - Discard the removed lip seal (non-reusable).

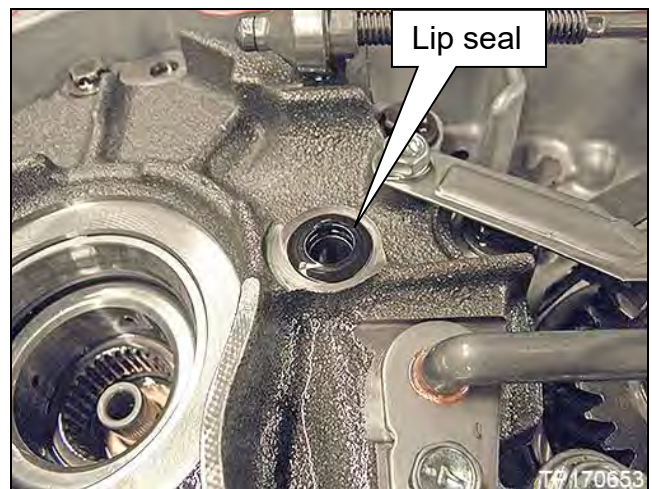

Figure 2H

3. Remove the O-ring from the CVT case.
  - Discard the removed O-ring (non-reusable).

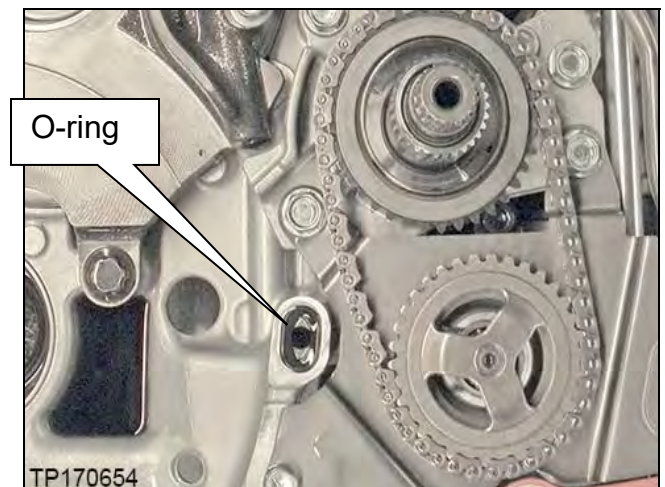

Figure 3H

4. Remove the O-ring from the input shaft.
  - Discard the removed O-ring (non-reusable).
5. Remove the thrust bearing from the drive sprocket and set aside to reuse during re-assembly.

**NOTE:** The thrust washer for the thrust bearing may either be on the drive sprocket or may have remained with the torque converter housing when it was removed.

- The thrust washer will be reused later in this procedure.

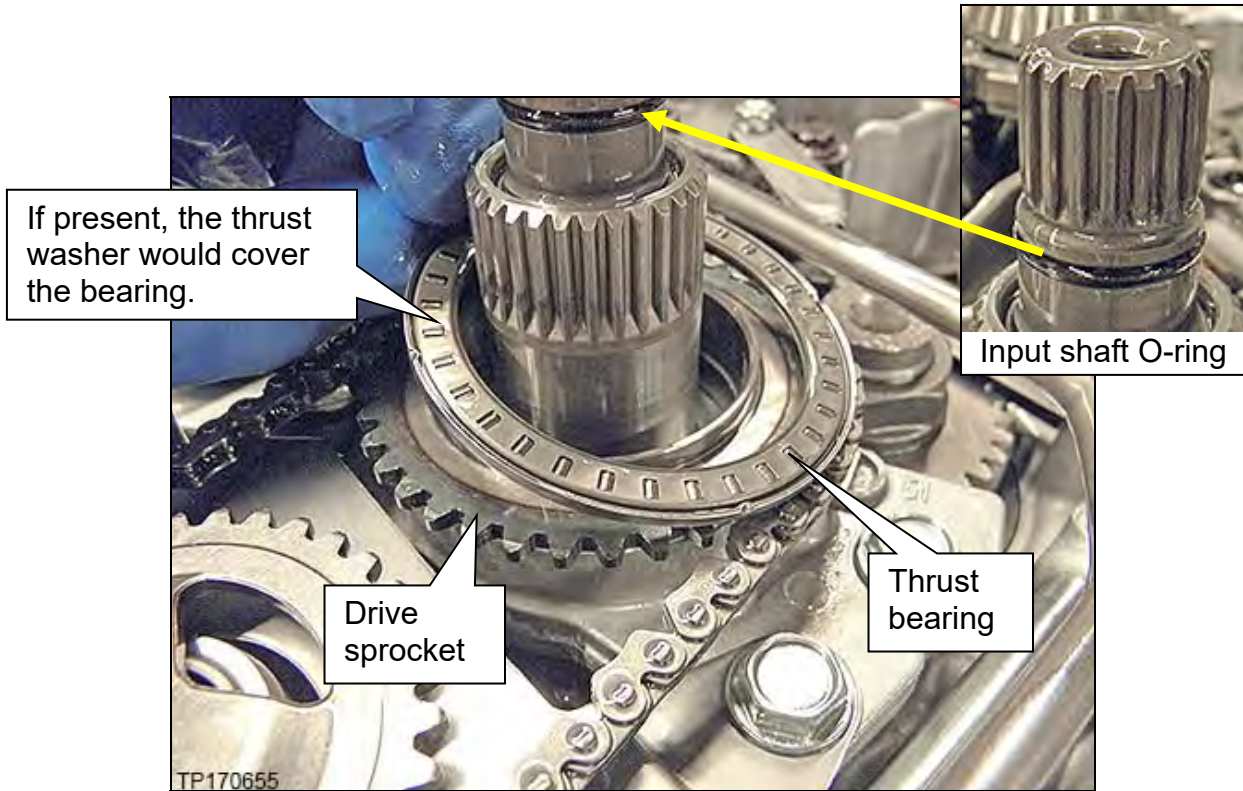

Figure 4H

6. Spread the snap ring shown in Figure 5H and then remove both sprockets and the chain.

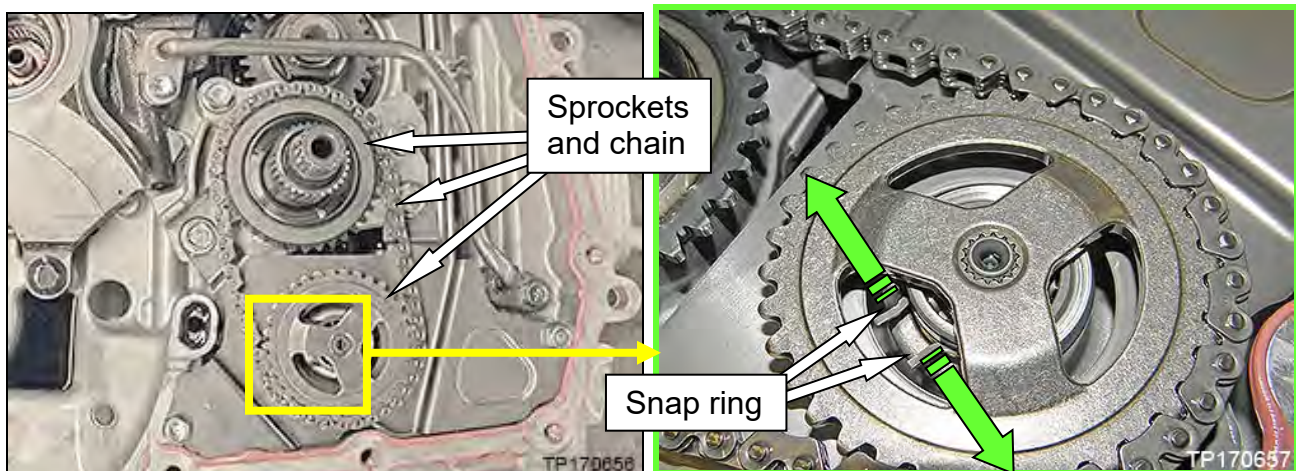

Figure 5H



7. Remove the parking rod from the detent plate.
  - Rotate the parking rod vertically to align the tab on the parking rod (Figure 7H) with the slot on the detent plate and then separate from the detent plate.

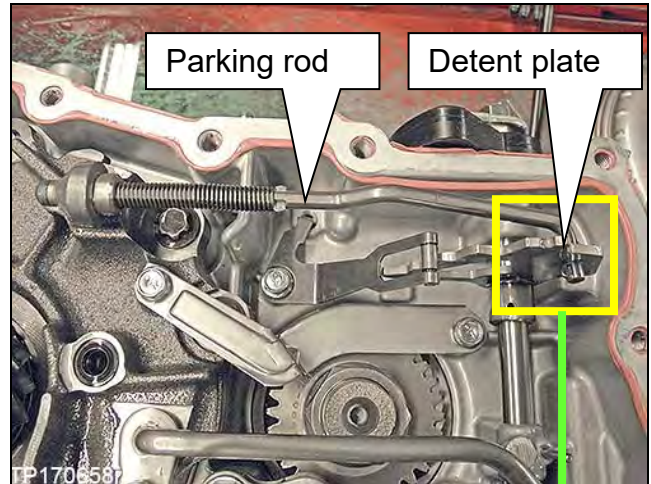

Figure 6H

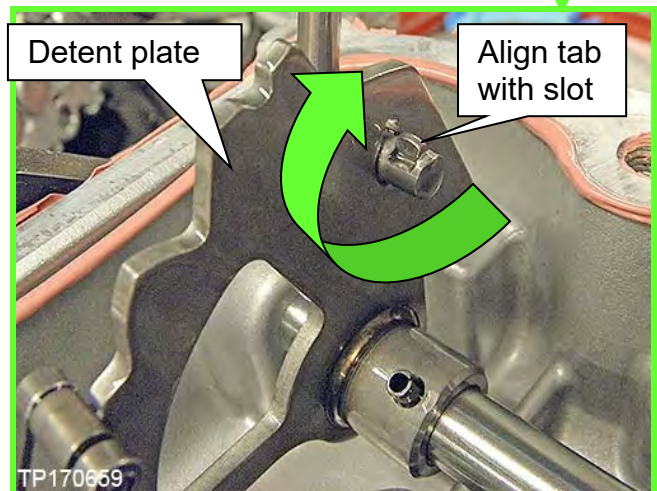

Figure 7H

8. Remove the two (2) bolts shown in Figure 8H and then remove the reverse brake tube from the CVT.
- Do not discard. These will be reused during assembly.

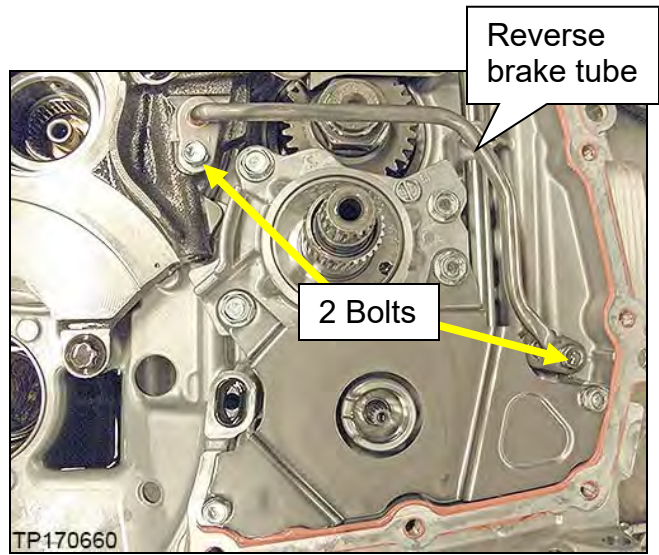

Figure 8H

9. Remove the sleeve from the reverse brake tube.
- Discard the removed sleeve (non-reusable).

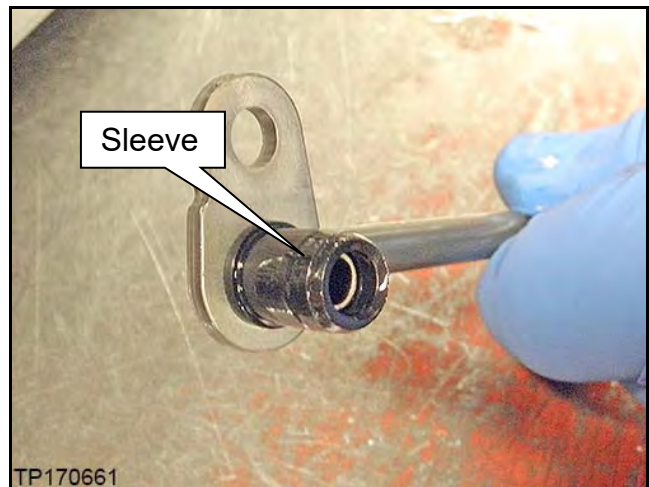

Figure 9H

10. Remove the six (6) bolts shown in Figure 10H and then remove the chain cover.
- Do not discard. These will be reused during assembly.

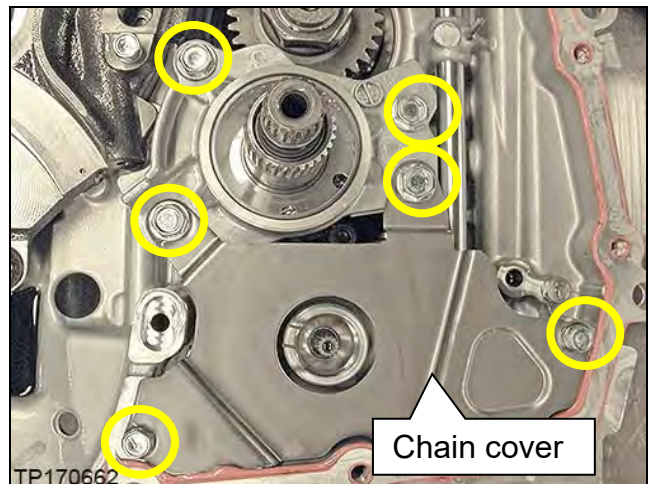
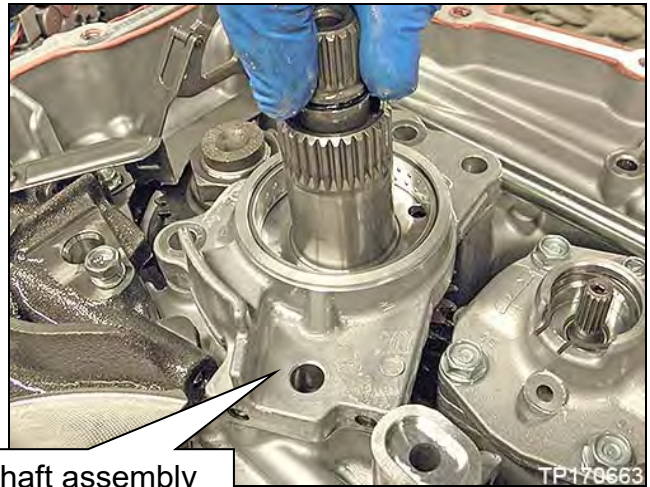

Figure 10H

11. Remove the input shaft assembly and the oil pump cover (dummy cover) from the CVT as a unit.

- Hold the input shaft assembly by the end, as shown in Figure 11H, and pull straight up to remove.

**CAUTION:** If the input shaft is not held at the end the dummy cover, shaft and bearing will separate.



Input shaft assembly and the oil pump cover (dummy cover)

Figure 11H

12. Confirm the “type” of bearing used on the end of the input shaft, and then proceed to the indicated step.

- For type “A” Roller Bearing proceed to step 13 on page 36.
- For type “B” Ball Bearing skip to step 15 on page 37.
- For type “C” Sealed Ball Bearing skip to step 15 on page 37.



Bearing type A

Figure 12H

Bearing type B and C.  
• Type C shown

13. Remove the outer race of the roller bearing from the counter bearing bore of the CVT case by hand.

**CAUTION:** Do not use excessive force to remove the bearing race. A magnet can be used to lift this bearing if needed.

**NOTE:** The outer race of the roller bearing might remain on the shaft when removing the input shaft and dummy cover.

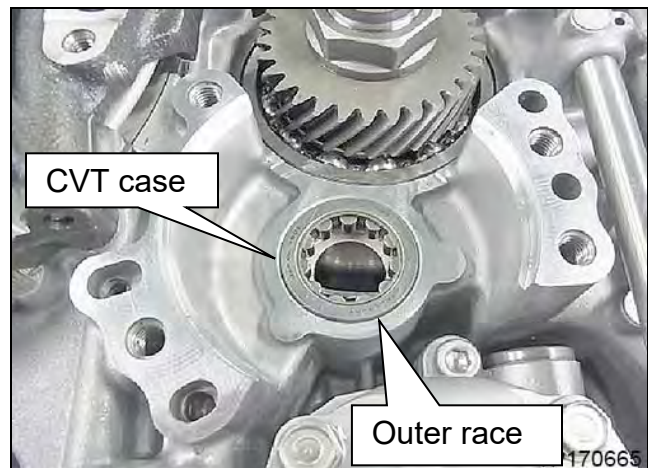

Figure 13H

14. Inspect type “A” bearing (Roller bearing) as follows:

- Inspect the bearing outer race and input shaft for flaking and/or pitting.
- Install the bearing outer race onto the input shaft assembly with the “bearing number” facing the gear, and then rotate the bearing while applying an axial load by hand to check for any abnormality.

**CAUTION:** DO NOT drop the outer race of the bearing.

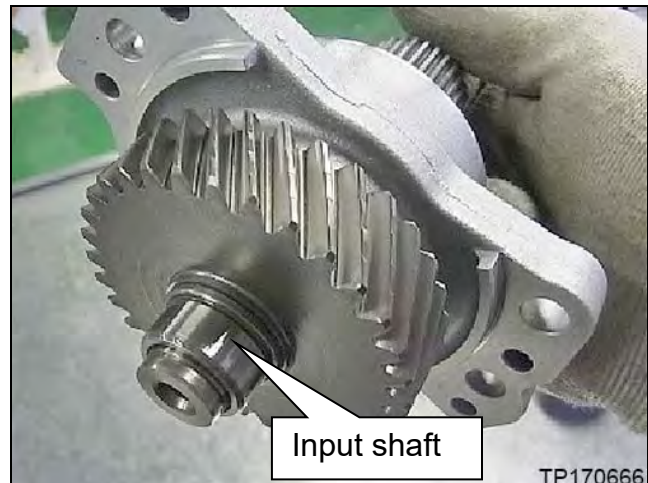

Figure 14H

➤ Were any abnormalities found or felt in the bearing (sound, flat spots, flaking)?

○ **NO:** Put bearing and shaft aside and then skip to step 16 on page 37.

○ **YES:**

a) Document the abnormalities found with video and then contact the PCC for authorization to replace the CVT. See page 137 for PCC contact information.

b) Loosely re-assemble the CVT in the reverse order of disassembly with the original parts.

c) Refer to the ESM, section TM – Transaxle & Transmission for CVT replacement.

15. Inspect type “B” and type “C” bearings (ball bearing) as follows:

- Apply an axial load and rotate the bearing by hand to check for any abnormality (sound, flat spot, flaking).
  - Were any abnormalities observed in the bearing when applying an axial load (sound, flat spots, flaking)?
    - **NO:** Proceed to step 16.
    - **YES:**



Figure 15H

- a) Document the abnormalities found with video and then contact the PCC for authorization to replace the CVT. See page 137 for PCC contact information.
- b) Loosely re-assemble the CVT in the reverse order of disassembly with the original parts.
- c) Refer to the ESM, section TM – Transaxle & Transmission for CVT replacement.

16. If the bearing is judged to be OK, remove the shim (Figure 16H) from the bottom of the counter bearing bore.

- A magnet can be used to remove the shim if needed.
- This shim will be reused later in this procedure.

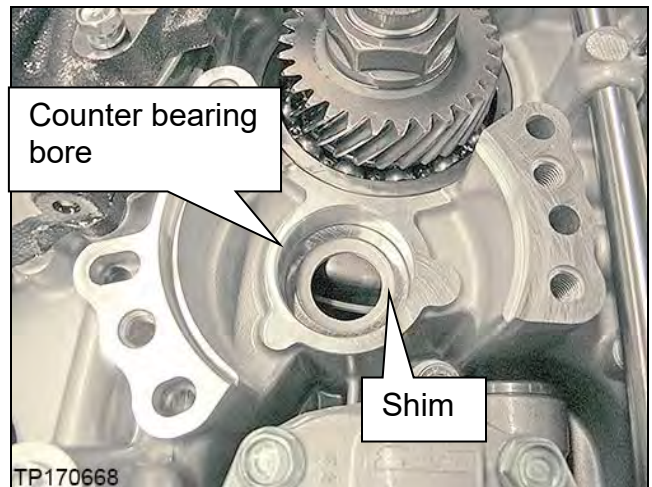

Figure 16H

17. Remove the differential side oil seal from the CVT case by driving it away from the case with a suitable tool.

- Discard the differential side oil seal (non-reusable).
- Take care not to damage the seal-to-case surface when removing seal.

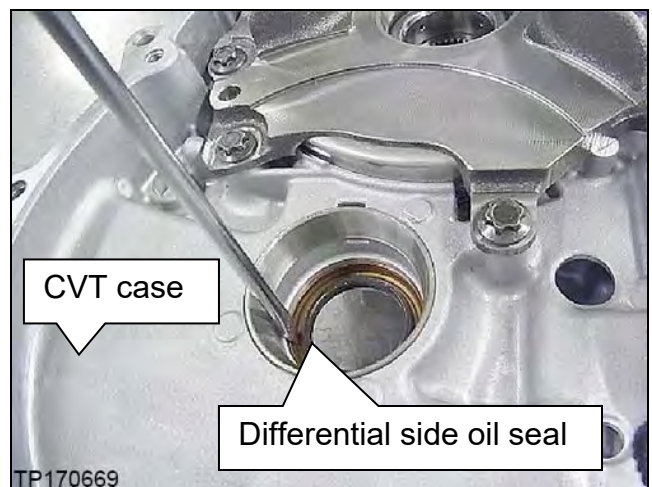

Figure 17H

18. Rotate the manual shaft (Figure 18H) until it stops in the park position (see Figure 19H).

**IMPORTANT:** Confirm that the detent plate is in the PARK position before proceeding. Do not remove the roll pin in any other position. This will allow pin removal and avoid damage to the case.

19. Remove the roll pin completely from the manual shaft with a 3 mm punch.

- Discard the roll pin (non-reusable).

**CAUTION:** Do not enlarge the hole by using an inappropriately sized punch.

**IMPORTANT:** Do not leave the roll pin in the CVT case.

20. Remove the detent spring bolt shown in Figure 19H and then remove the detent spring from the CVT case.

- Do not discard the bolt. It will be reused during reassembly.

21. Remove the manual shaft retaining pin (straight pin) from the CVT case by grasping and pulling vertically by hand.

- Do not discard the pin. It will be reused during reassembly.

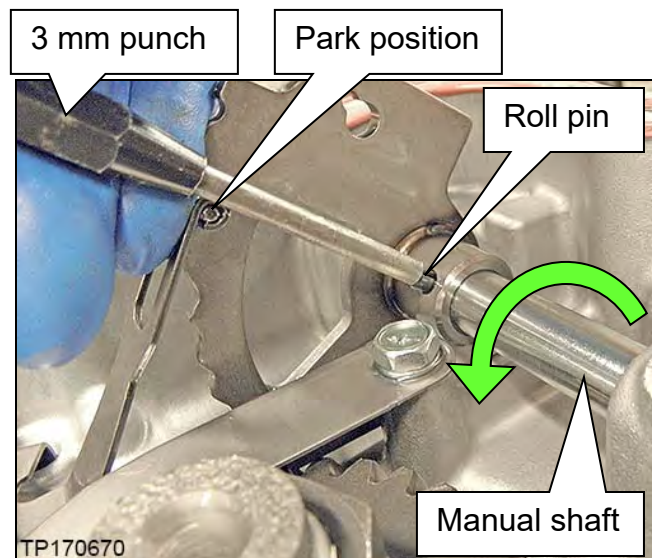

Figure 18H

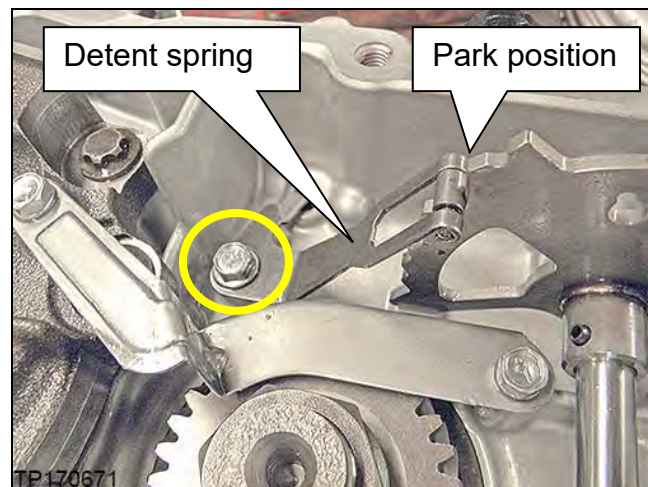

Figure 19H

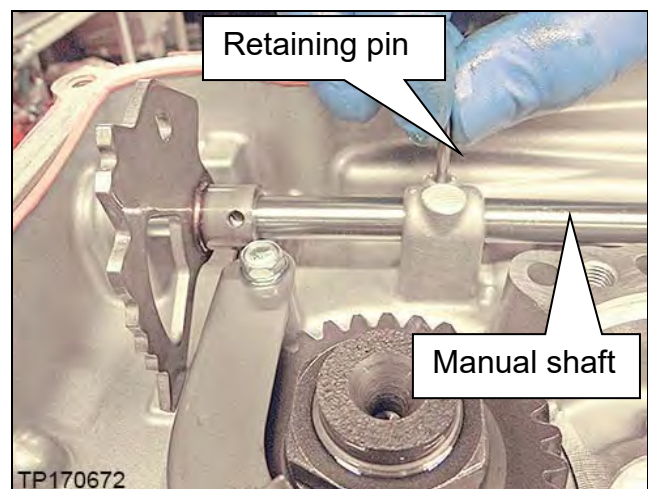

Figure 20H

22. Remove the two (2) bolts shown in Figure 21H for the transmission range switch.

- Do not discard the bolts. They will be reused during reassembly.

**CAUTION:**

- DO NOT remove the manual shaft lock nut at this step.
- DO NOT try to remove the transmission range switch from the manual shaft.

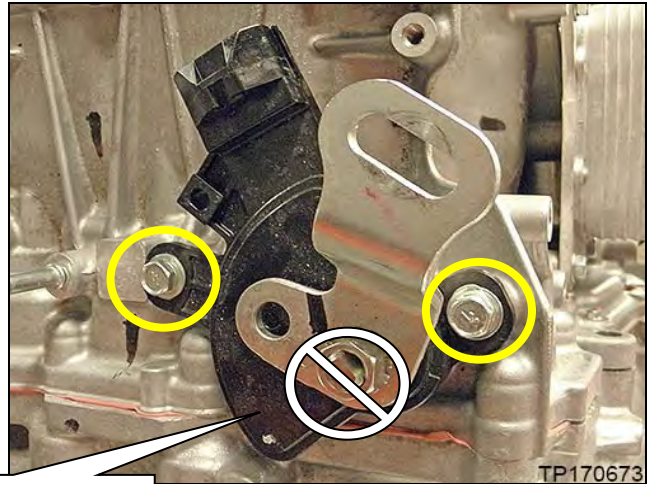

Transmission range switch

Figure 21H

23. Slide the manual shaft approximately 5.3 inches (135 mm) out of the CVT case to allow removal of the oil pump in step 24.

**CAUTION:** Do not remove the manual shaft completely from the CVT case. If the retaining pin slot contacts the seal damage may occur.

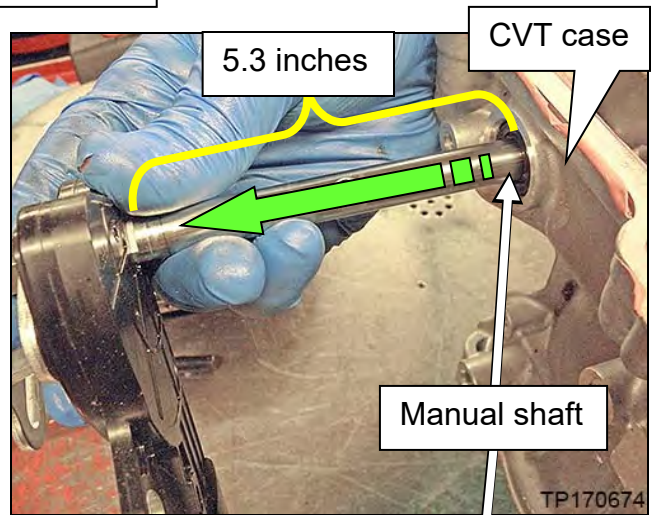

Figure 22H

24. Remove the three (3) Allen bolts shown in Figure 23H and then remove the oil pump from the CVT case.

- This oil pump will not be reused.
- Do not discard Allen bolts. They will be reused during reassembly.

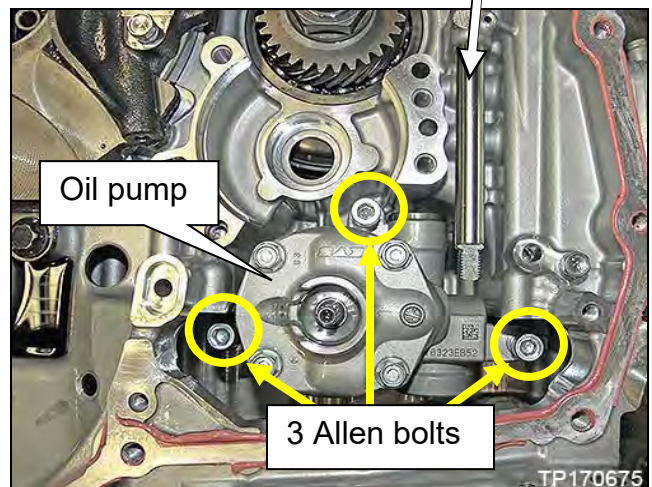

Figure 23H

25. Remove the snap ring from the original oil pump.

**CAUTION:** DO NOT discard the removed snap ring. This snap ring will be re-used.



Figure 24H

26. Remove the oil pump gasket from the CVT case.

- Discard the oil pump gasket (non-reusable).

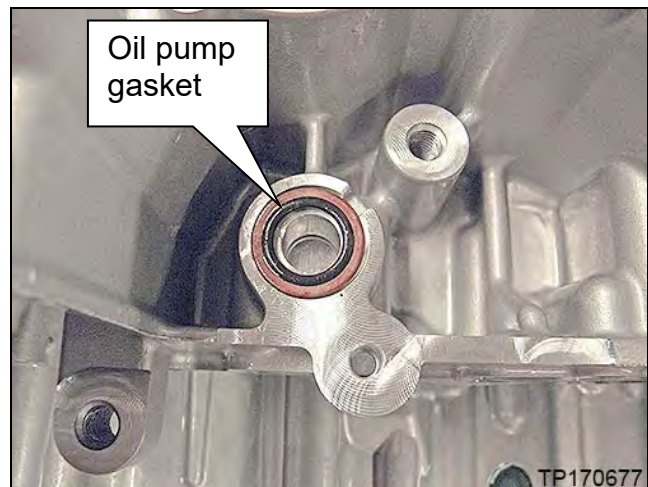

Figure 25H

27. Temporarily install the transmission range switch with the two (2) original bolts removed in step 22 on page 39, finger tight.

- The transmission range switch will be permanently installed later in this procedure.



## Remove the Sub-assembly

**IMPORTANT:** The following steps (1-8) are **ONLY** to separate the sealant of the side cover.

The sub-assembly with belt and pulley **CANNOT** be removed from the CVT while in this orientation and will be removed from the case at a later step.

1. Reposition the CVT on the work bench with the torque converter housing side down.

**NOTE:** A wood block may be used to stabilize the CVT during disassembly/reassembly.



Figure 1J

2. Remove the two (2) pulley bearing retainer bolts shown in Figure 2J.
  - Do not discard bolts. They will be temporarily installed during a later step.

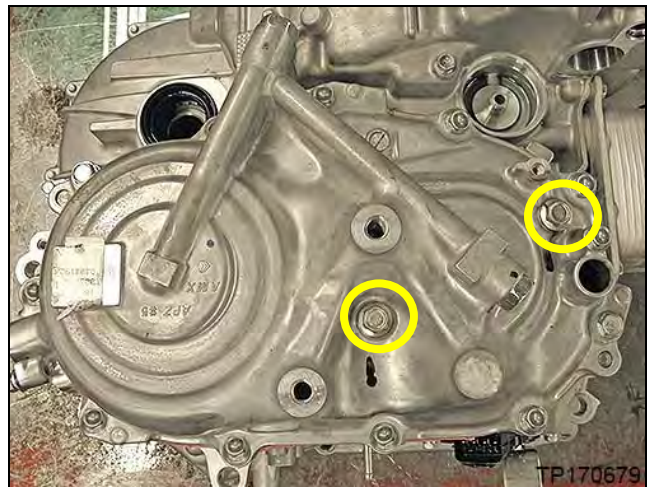

Figure 2J

3. Remove the eleven (11) side cover bolts shown in Figure 3J.
  - Retain two (2) of these bolts. They will be temporarily installed during a later step.

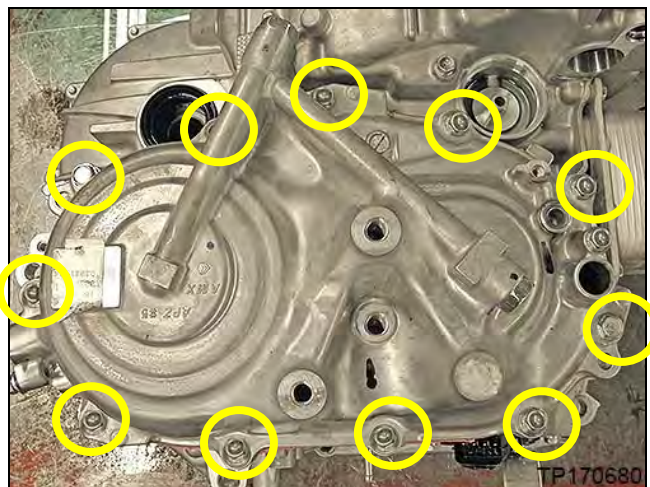

Figure 3J

4. Remove the side cover with a slide hammer (J-25721-A) to separate the side cover and CVT case.
- There are three slide hammer tool points shown in Figure 4J.
  - The mating surfaces will be cleaned at a later step.
  - This step will help with sub-assembly removal at a later step.

**CAUTION:**

- Do not use the speed sensor bore for slide hammer tool location.
- Do not pry the surfaces apart as internal damage may result.

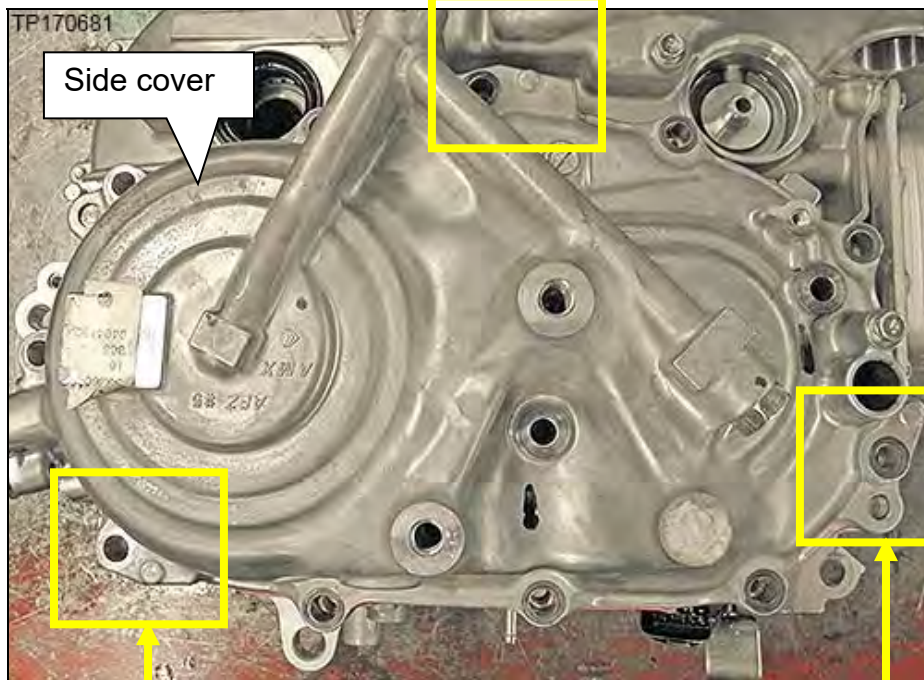
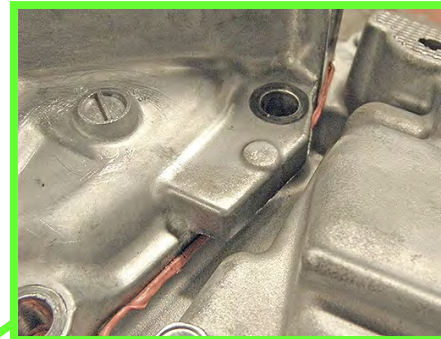
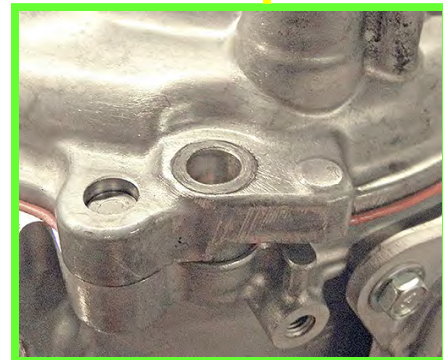
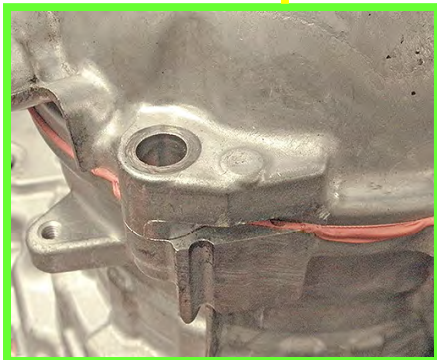

Figure 4J



5. Align the primary pulley bearing retainer bolt holes with the bolt hole on the case as shown in Figure 5J.

**NOTE:** This helps alignment of the bearing retainer bolt threads after re-installing the original side cover.

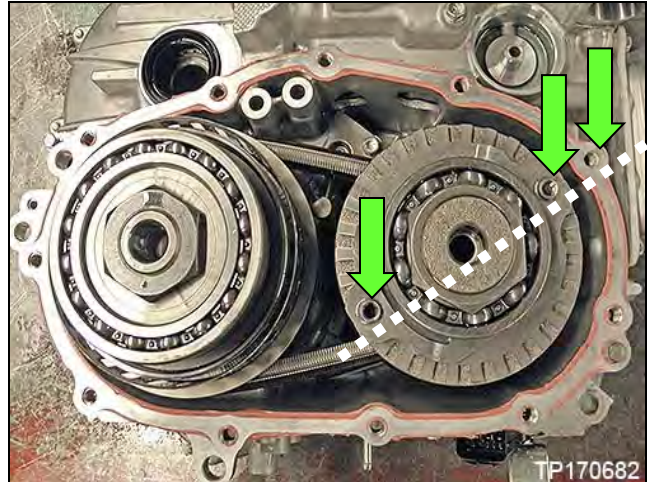

Figure 5J

6. Install one of the “Assembly Guide Pins, Pulley Bracket” (Guide Pin J-52272) to one of the two pulley bearing retainer bolt holes.
  - This will assist in installation of the original side cover to the pulley assembly.

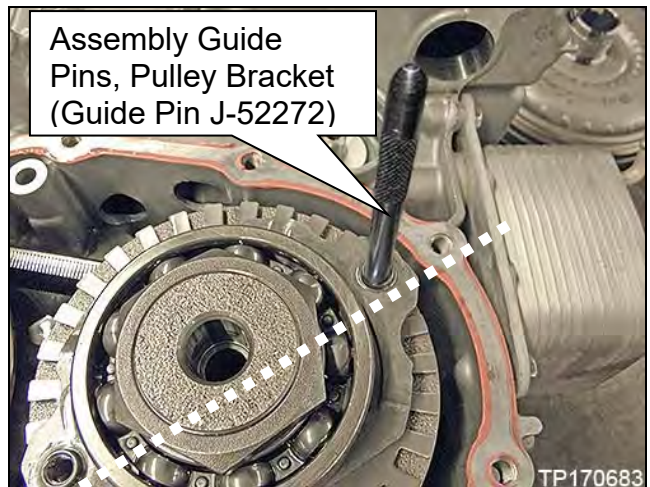

Figure 6J

7. Place the original side cover onto the CVT case.
  - Position the primary pulley bearing retainer to allow the guide pin to be inserted through the bolt hole of the side cover.

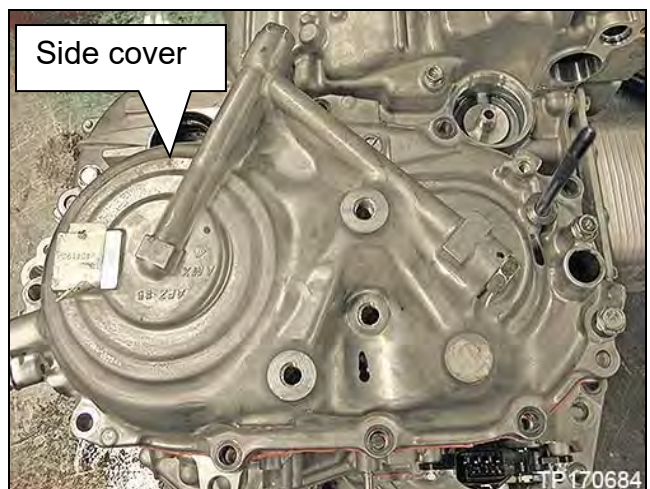

Figure 7J

8. Install the two (2) original pulley bearing retainer bolts (Figure 8J) as follows:
- Use the original bolts and O-rings at this step.
    - a. Install one pulley bearing retainer bolt by hand (finger tight) into open bearing retainer bolt hole.
    - b. Remove the Guide Pin from the other bearing retainer bolt hole.
    - c. Install the other bearing retainer bolt by hand (finger tight).
9. Temporarily reattach the removed side cover onto the CVT case with two (2) original bolts on opposite corners, hand tight.

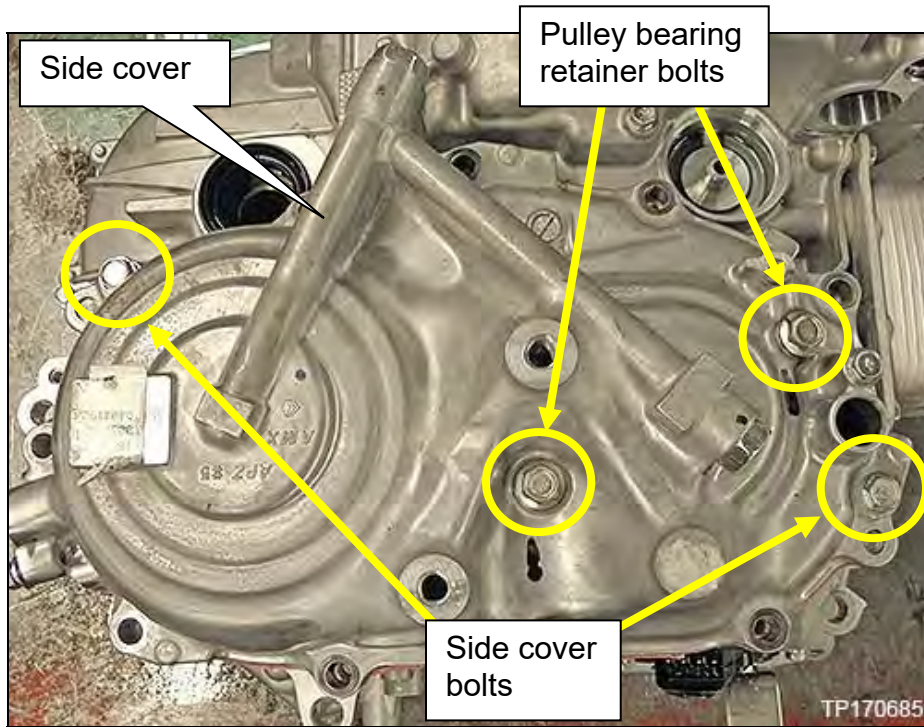

Figure 8J

10. Reposition the CVT with the side cover facing down.

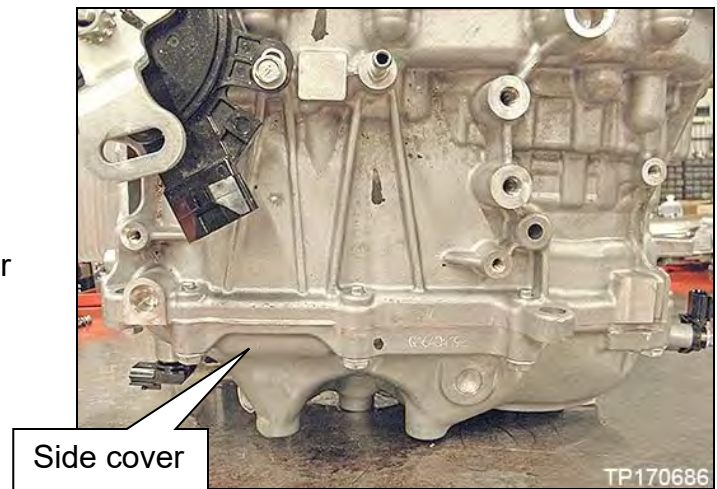

Figure 9J

11. Remove the two (2) side cover bolts which were temporarily installed to hold the side cover to the CVT in step 9 on the previous page.

**NOTE:** Only one (1) bolt is shown in Figure 10J and is for reference only.



Figure 10J

12. Lift the CVT case vertically off of the sub-assembly and side cover.

- Weight: 17.4 kg (38.4 lbs.)
- This sub-assembly will not be reused.

**IMPORTANT:** The sub-assembly must be separated from the case as shown in Figure 11J.



Figure 11J

13. Place the CVT case on the work bench with the torque converter side facing down.



Figure 12J

14. Remove the lubrication tube bolt shown in Figure 13J and then remove the lubrication tube from the CVT case.

- Do not discard the bolt or lubrication tube. These will be reused during reassembly.

**IMPORTANT:** This step is to ensure that the lubrication tube is not bent during sub-assembly installation.

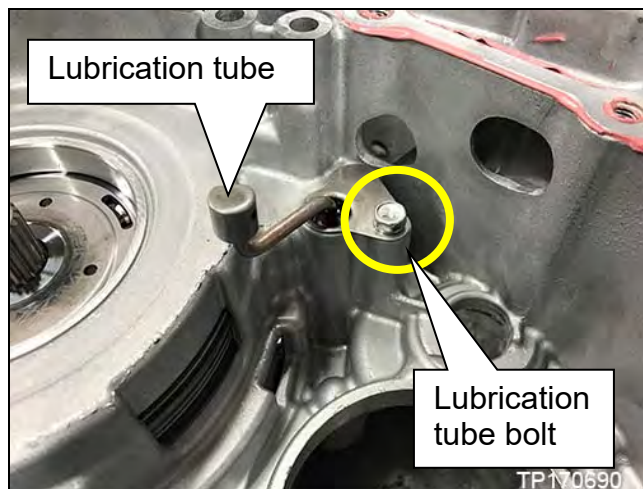

Figure 13J

## Clean the CVT Surfaces

**CAUTION:** During the next two steps;

- Avoid any debris from dropping into the torque converter housing, side cover or the CVT case. It is extremely important to keep any debris away from CVT internals to prevent drivability concerns.
- Use brake cleaner to remove the remaining CVT fluid and any residual sealant.
- Do not use sanding discs, abrasive tools, or metal blades on sealing surfaces.
- To clean dowel pins a mild abrasive sandpaper can be used to remove all rust and debris.
  - This will assist at a later step when mating the CVT Case to the sub-assembly and again when mating the CVT Case to the torque converter housing.

1. Remove any sealant that remains on the sealing surface of the CVT case where it seals with the sub-assembly side cover.

- A plastic scraper can be used.
- Use ONLY brake cleaner to clean surfaces.
- Clean with a lint-free paper towel.

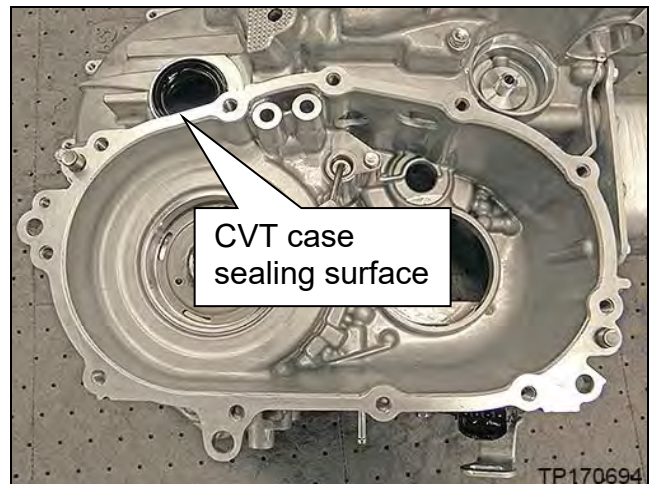

Figure 1K

**CAUTION:** Debris must be kept out of the inside of the CVT and transmission range switch connection to prevent possible drivability concerns.

2. Remove any sealant that remains on the sealing surfaces of the torque converter housing and CVT case using a plastic scraper, and then clean with a lint-free paper towel.
  - Use ONLY brake cleaner to clean surfaces.

**CAUTION:** Debris must be kept out of the inside of the CVT and transmission range switch connection to prevent a future drivability concern.

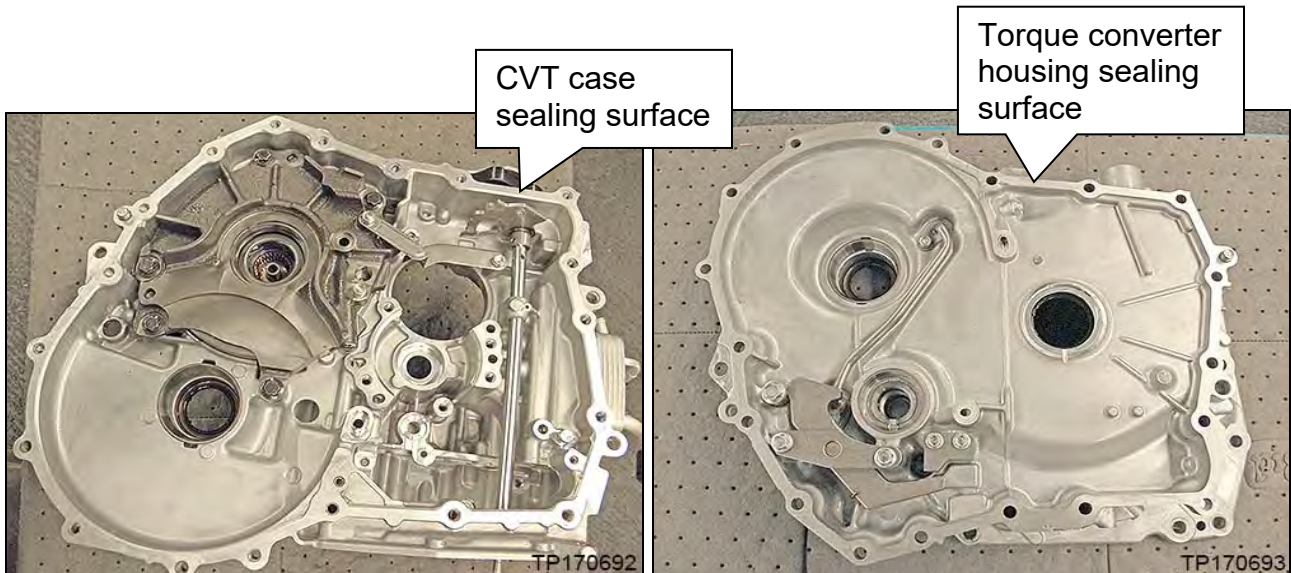

Figure 2K

Figure 3K



## Clean Oil Passages in CVT Case and Oil Pump Cover

In the following steps:

- Brake cleaner and compressed air will be used to clean out oil passages in the CVT assembly.

**WARNING:** Wear eye/face protection when using compressed air and cleaning fluids.

**CAUTION:** Regulate air pressure up to a maximum of 75 PSI.

1. Confirm the CVT case is on the work bench with sub-assembly side down.

- Use wood blocks as necessary to stabilize the assembly during these steps.

**CAUTION:** Make sure the surface of the work bench has been cleaned.

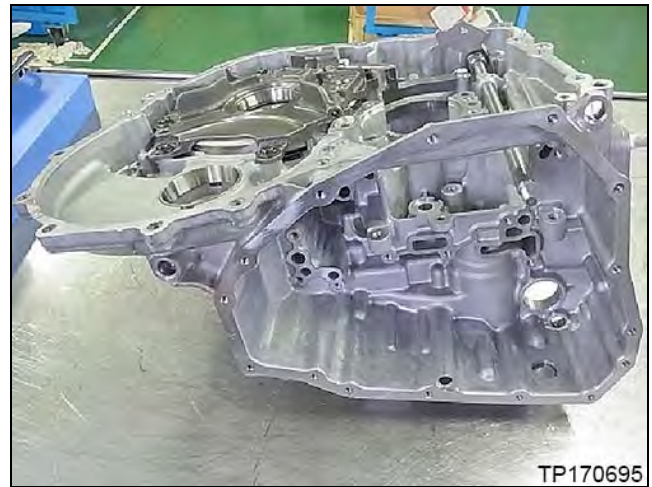

Figure 1L

2. Spray brake cleaner into each oil passage, indicated in yellow, of the CVT case where shown in Figure 2L and Figure 3L, until the fluid runs clear for 5 seconds.

**IMPORTANT:** Do not apply brake cleaner or compressed air to passages shown in white.

3. Apply compressed air in the same passages to remove remaining cleaner and debris.

**NOTE:** Do not stand in front of the passages while using compressed air.

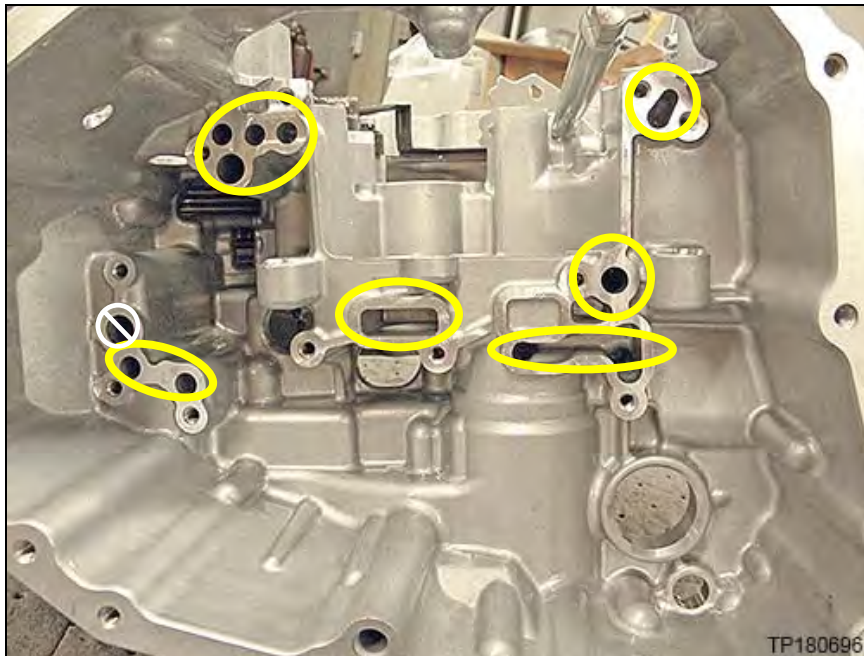

Figure 2L

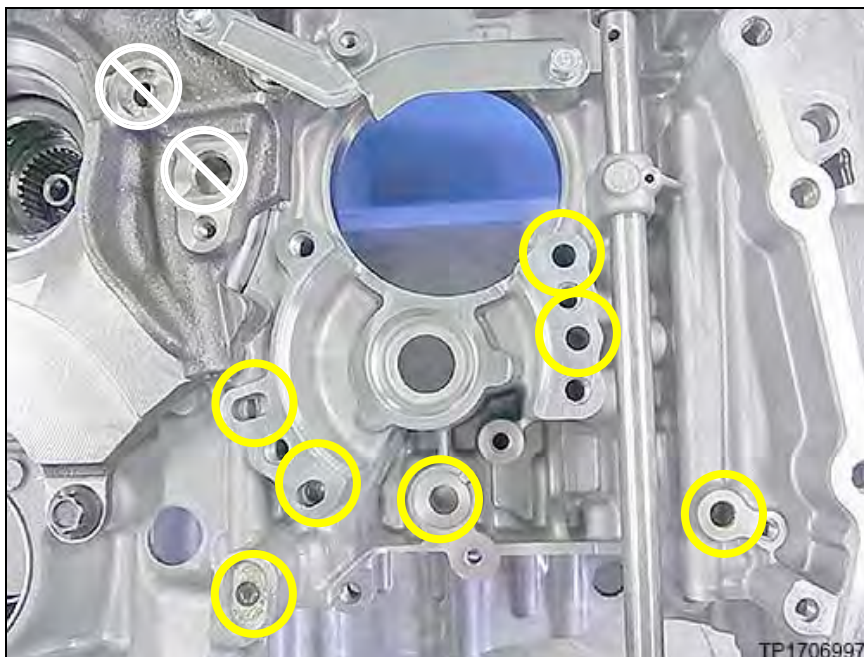

Figure 3L

4. Spray brake cleaner into the reverse brake tube.
  - Apply compressed air in the same passages to remove remaining cleaner and debris.

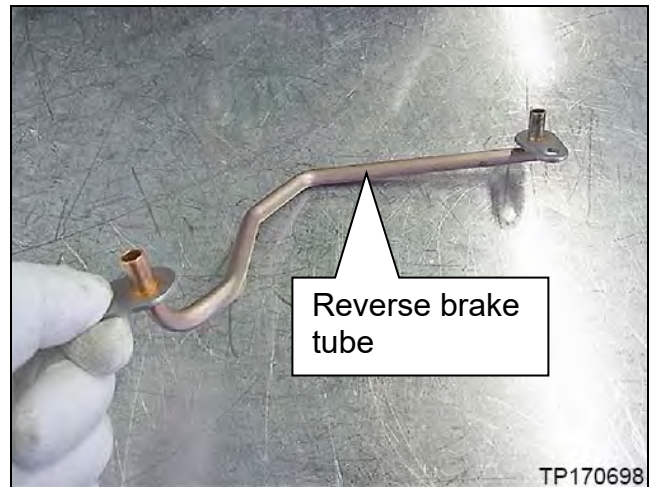

Figure 4L

5. Clean the input shaft bearing bore area (Figure 5L).

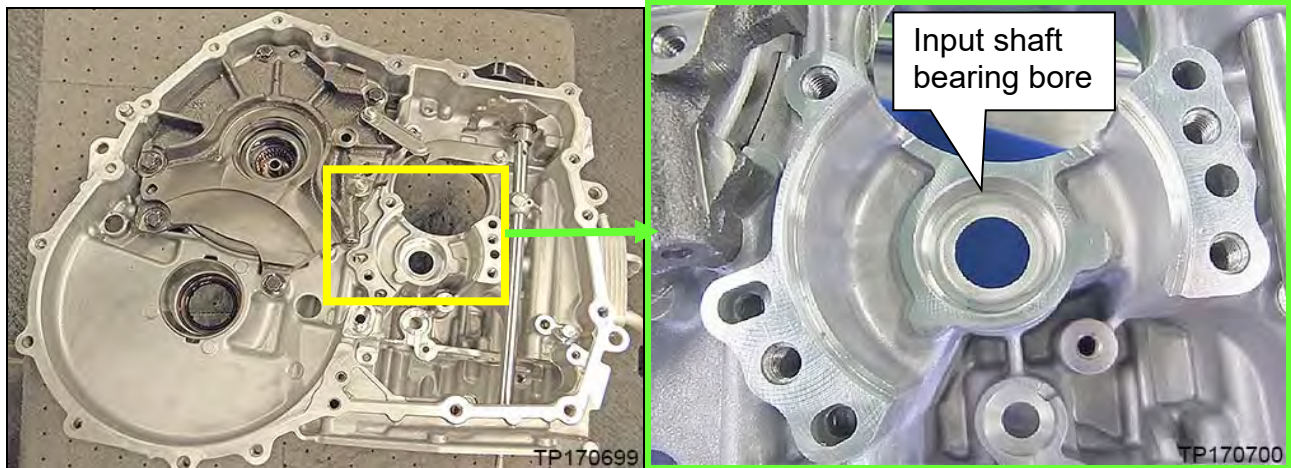

Figure 5L

6. Spray brake cleaner into the high clutch fluid passage on the torque converter housing.

**CAUTION:** Brake cleaner will exit the passage shown as “fluid discharge” in Figure 6L while cleaning passage.

- Apply compressed air in the same passages to remove remaining cleaner and debris.

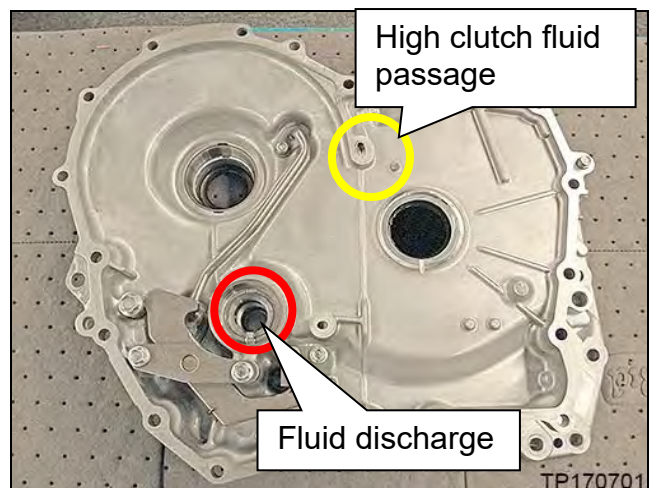

Figure 6L

7. Spray brake cleaner into the reduction gear bearing fluid passage on the torque converter housing.

**CAUTION:** Do not face the passage indicated in red of Figure 7L while cleaning.

- Apply compressed air in the same passages to remove remaining cleaner and debris.

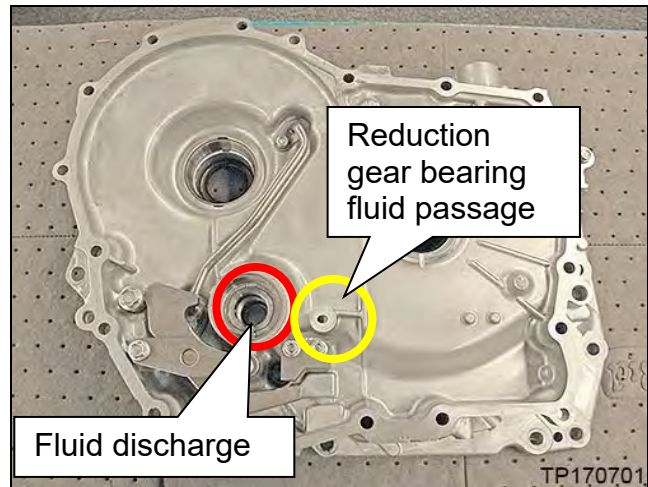

Figure 7L

8. Clean the passages of the oil pump cover as follows:

- a. Remove the input shaft from the oil pump cover.

**CAUTION:** Do not drop the counter bearing outer race (roller bearing type only).

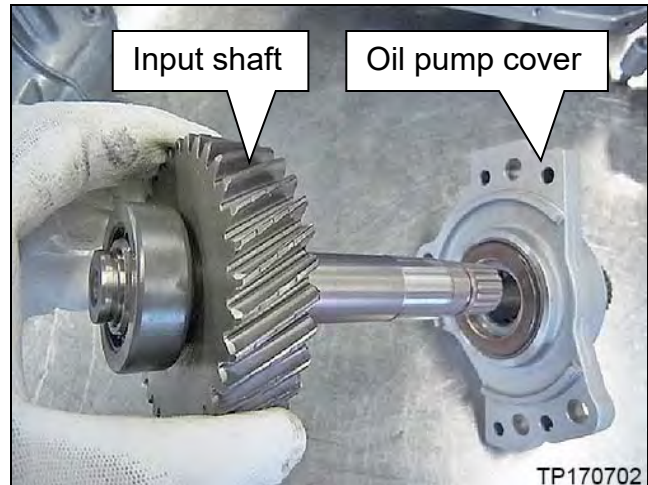

Figure 8L

- b. Note the orientation and then remove the thrust bearing.

- Do NOT discard. This will be reused at a later step.

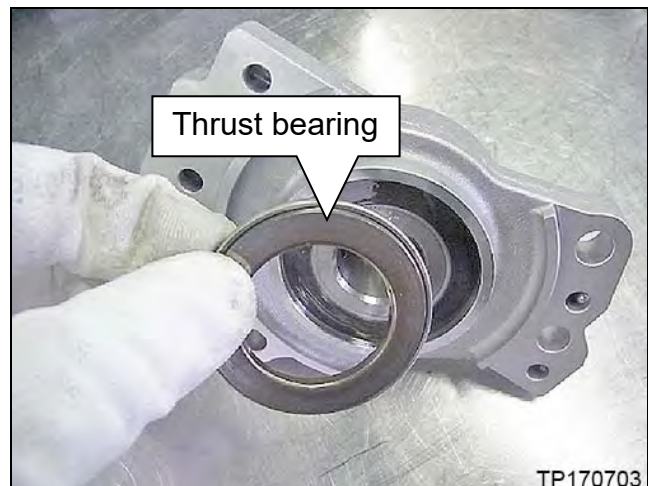

Figure 9L

- c. Remove the washer.
  - Do NOT discard. This will be reused at a later step.
- d. Spray brake cleaner into the oil pump cover oil passages indicated in yellow shown in Figure 11L.
  - Apply compressed air in the same passages to remove remaining cleaner and debris.

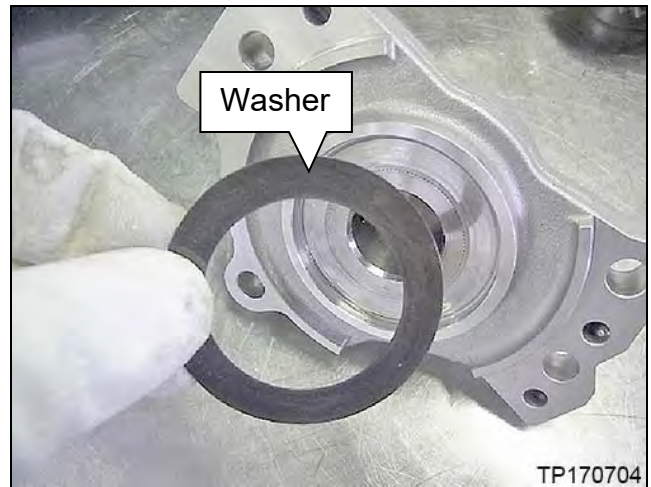

Figure 10L

**CAUTION:** Do not face the passage indicated in white in Figures 11L and 12L while cleaning.

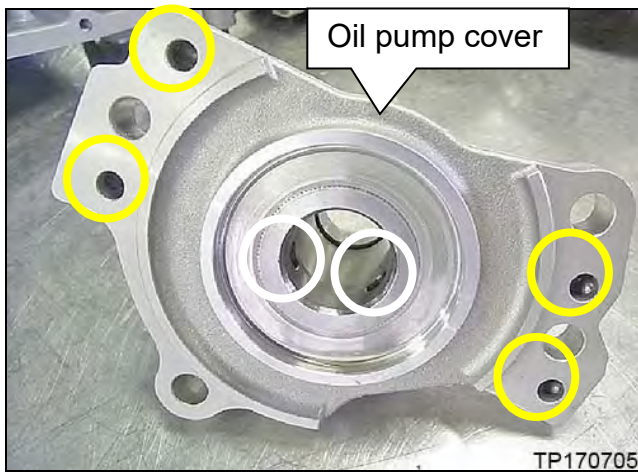

Figure 11L

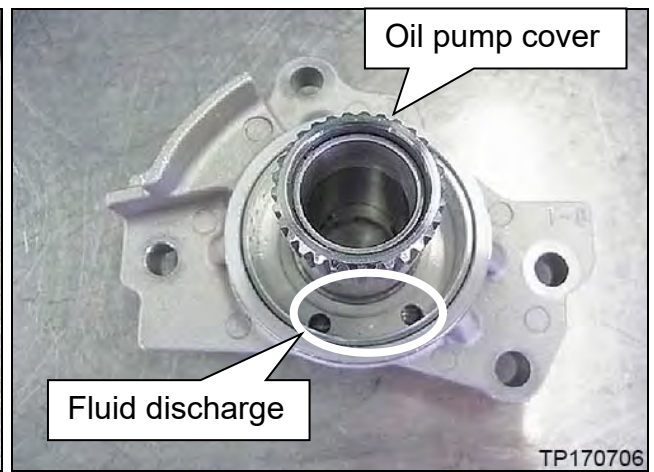

Figure 12L

- e. Install the original washer.

**NOTE:**

- Orientation is NOT critical for the washer.
- Apply petroleum jelly to the washer to hold it in place during assembly.

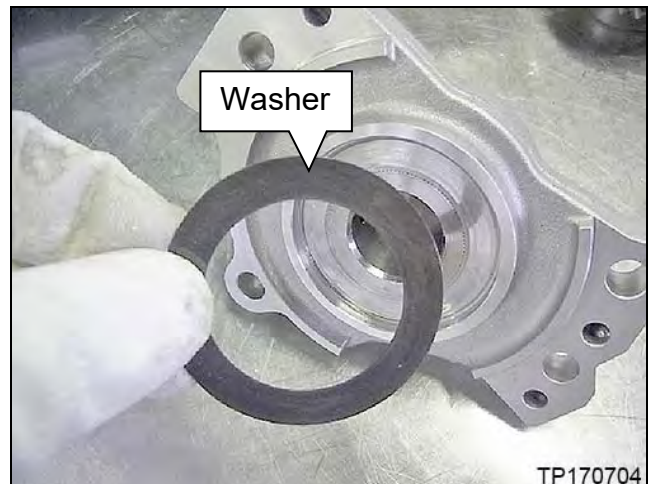

Figure 13L

f. Install the original thrust bearing.

- **Orientation IS critical.** See Figure 14L and Figure 15L for thrust bearing cross section.

**CAUTION:**

- The thrust bearing has two sides. Refer to Figures below.
- Apply petroleum jelly or equivalent to hold in place.

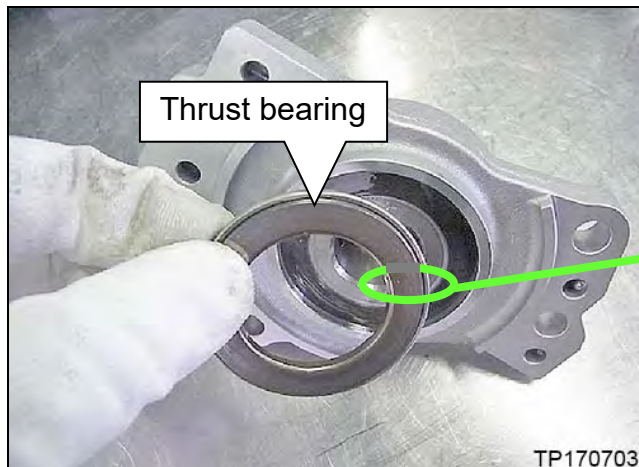

Figure 14L

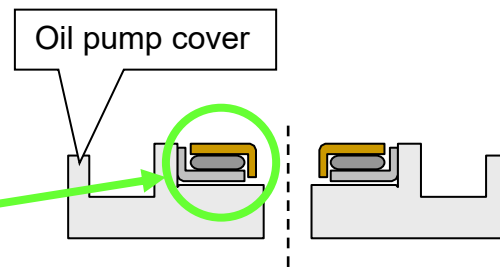

Figure 15L

g. Insert the input shaft to the oil pump cover (Figure 16L).

**CAUTION:**

- The input shaft has a sealing ring.
- Be careful not to damage the sealing ring while assembling the input shaft to the oil pump cover.
- Apply petroleum jelly to the sealing ring on the input shaft before installation.
  - Sealing ring is hidden behind input gear in Figure 16L.

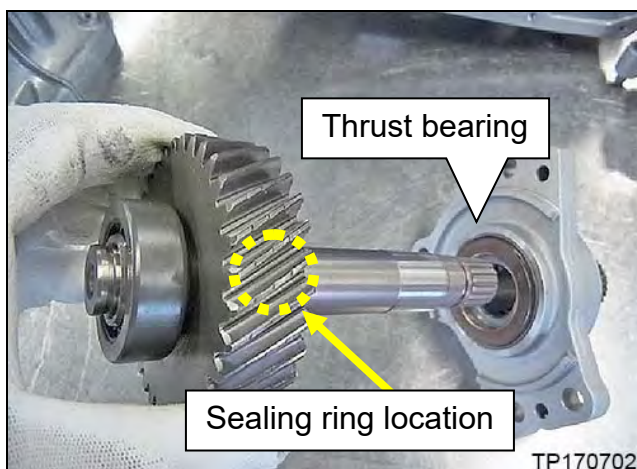

Figure 16L



Figure 17L

- Make sure all exposed internal areas of the CVT (including the oil pan and magnets) have been thoroughly cleaned.
- Cover all parts with a lint-free covering, when not being worked on, to prevent contamination which could cause drivability concerns.

## Measuring the CVT Sub-assembly Case Depth

1. Temporarily install the torque converter housing to the CVT case with two (2) bolts at opposite corners, hand tight (Figure 1M).

- Use original bolts to secure.

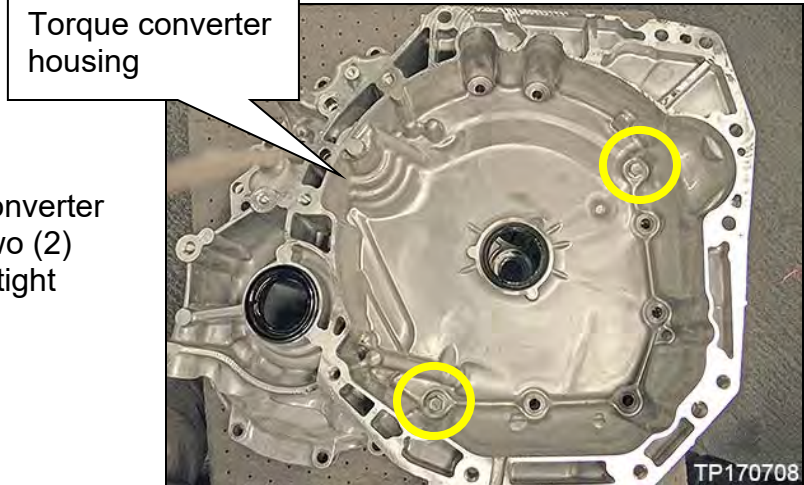

Figure 1M

2. Reposition the CVT on the work bench with the torque converter housing side facing down (Figure 2M).

3. Clean and then zero the Digital Depth Gauge (J-50272).

4. Set the Digital Gauge to millimeters.

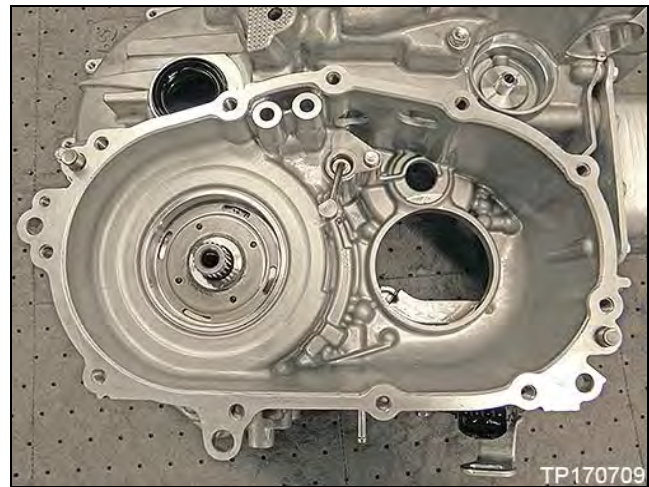

Figure 2M

5. Clean the Gauge Block (J-50271).

**NOTE:** Only if a Gauge Block (J-50271) is not available, measurement "X" (Figure 5M, page 56) will need to be determined for the measuring bar being used. This can be done either with a set of calipers or with Digital Depth Gauge (J-50272).

6. Confirm the sealing surfaces of the CVT case are clean.

7. Place Gauge Block (J-50271) across sub-assembly sealing surface as shown in Figure 3M.

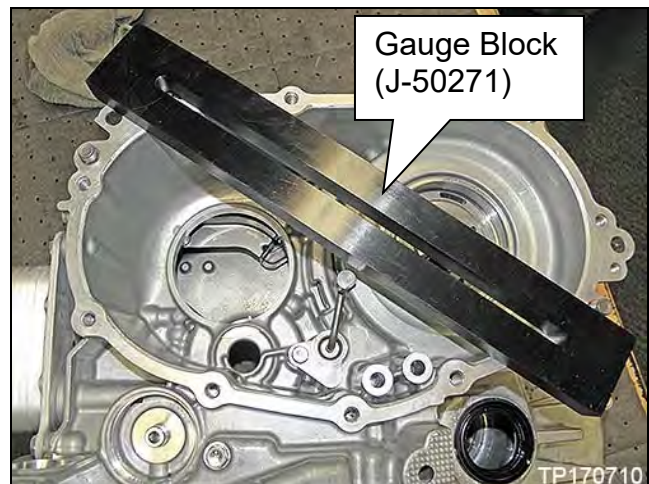

Figure 3M

8. Measure the average distance (**Y**) shown in Figure 5M as follows:

- Refer to the Figures 4M and 5M and then proceed to page 57.
- Measure only from areas that do not have any signs of contact.

**IMPORTANT:** Please refer to Figure 4M for acceptable areas (highlighted in green) to measure “**Y**”.

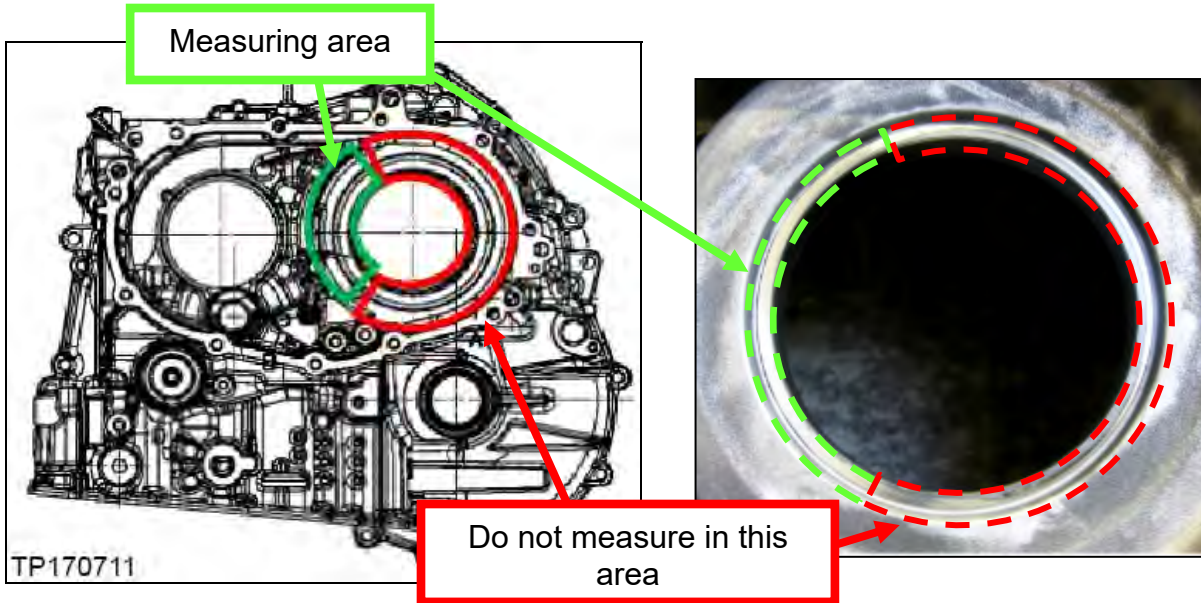

Figure 4M

**Y** = The distance between the upper surface of the Gauge Block and the surface where snap ring seats.

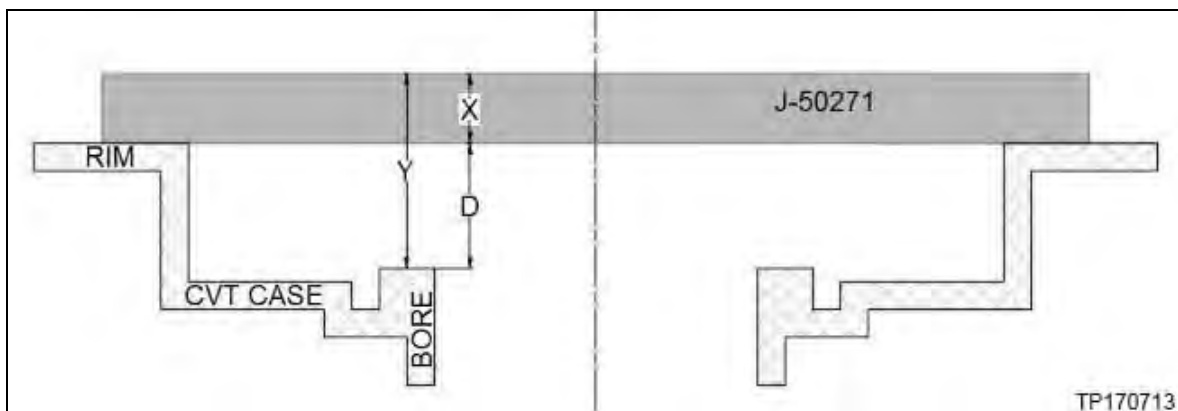

Figure 5M

Proceed to the next page.



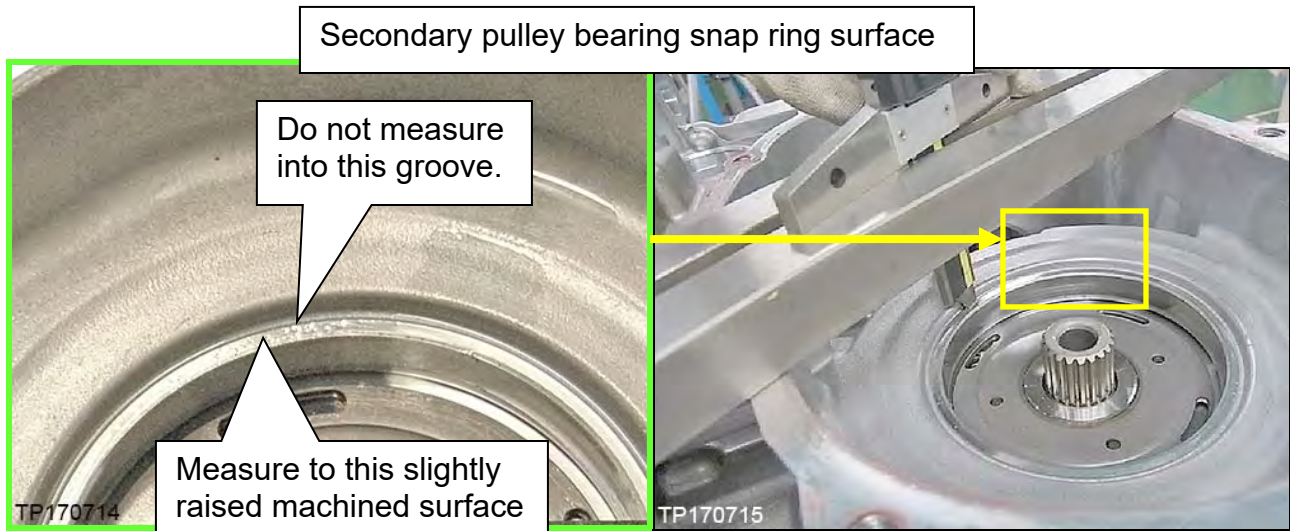

Figure 6M

- a. Measure between the top of the Gauge Block (J-50271), to where the snap ring on the secondary pulley bearing seats (Figure 6M).

- This will be measured in three locations to calculate an average for “Y”.

Y1 \_\_\_\_\_, Y2 \_\_\_\_\_, Y3 \_\_\_\_\_

- b. Calculate the average for “Y” with the formula below and then record it below.

$$Y = \frac{(Y1+Y2+Y3)}{3} \text{ (millimeter)}$$

Y = \_\_\_\_\_

- c. Calculate case depth “D” as follows:

**IMPORTANT:** Essential tool Gauge Block (J-50271) is **20 mm** thick.

- Average depth calculated in step 8b → Y \_\_\_\_\_
- Subtract Gauge Block thickness → − X \_\_\_\_\_
- Calculated depth → = D \_\_\_\_\_

**D** = Distance between the sub-assembly sealing surface and the secondary pulley front bearing surface with the snap ring attached.

**EXAMPLE:**

If Y = 61.39 mm  
 And − X = 20.00 mm  
 D = 41.39 mm

## New Snap Ring Selection and Installation to the New Sub-assembly

1. Remove the top of the shipping box of the new sub-assembly.

**NOTE:** Outer cardboard of the shipping box can be disassembled for easy removal of the sub-assembly by removing the shipping tape.



Figure 1N

2. Remove the upper board with foam spacer assembly.
  - Packing material may be different then what is shown in Figure 2N.

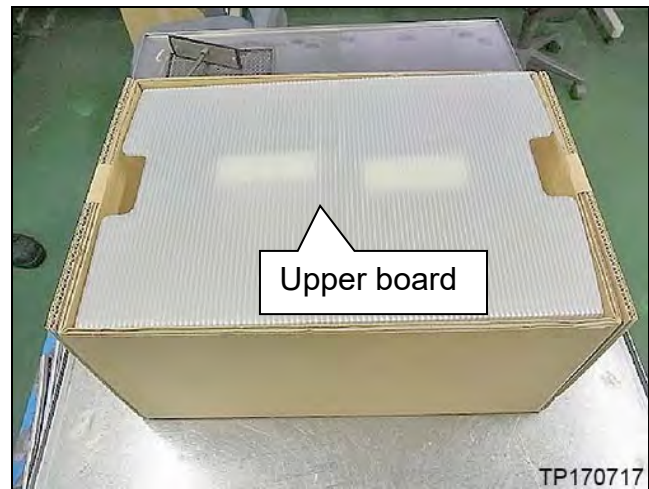

Figure 2N

3. Locate the data sheet in the shipping box and place it in a safe place.
  - This data sheet is required for snap ring selection in the following steps.

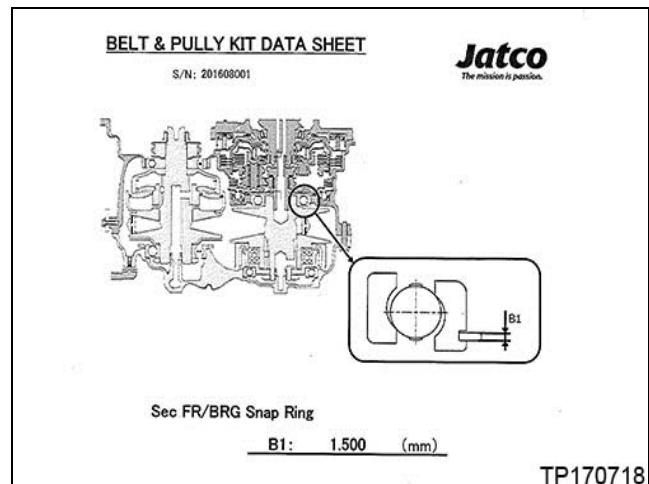

Figure 3N

4. Locate the plastic bag which contains the snap rings (Figure 4N).

- There are six individual snap rings in the plastic bag.
- Take the plastic bag out of the shipping box, and put aside on the work bench.

**NOTE:** See **Reference # 5** in the **KIT PARTS REFERENCE TABLE**.



Figure 4N

5. Take the new sub-assembly out of the shipping box and place it on the work bench.

**CAUTION:**

- Hold the sub-assembly by the side cover **ONLY** when removing it from the shipping box.
- **DO NOT** handle the belt or pulleys of the sub-assembly when removing from the shipping box.
- **DO NOT BREAK** the foam cushion in the shipping box. This will be used as a stabilizer for the sub-assembly during the repair.



Figure 5N

**NOTE:** See **Reference # 4** in the **KIT PARTS REFERENCE TABLE**.

6. Take the lower board with foam cushion (lower board) out of the shipping box (shown in Figure 7N).

**IMPORTANT:** Step 7 is for kits that have a separate spacer (Figure 6N). In later kits this spacer will be part of the lower board and step 7 will not be used.

7. Take the spacer (Figure 6N) out of the shipping box and place on the work bench where the sub-assembly will be installed, and then place the lower board on top of the spacer as shown in Figure 7N.

**NOTE:** The spacer will be the last item that is removed from the shipping box and is approximately 1 inch thick.

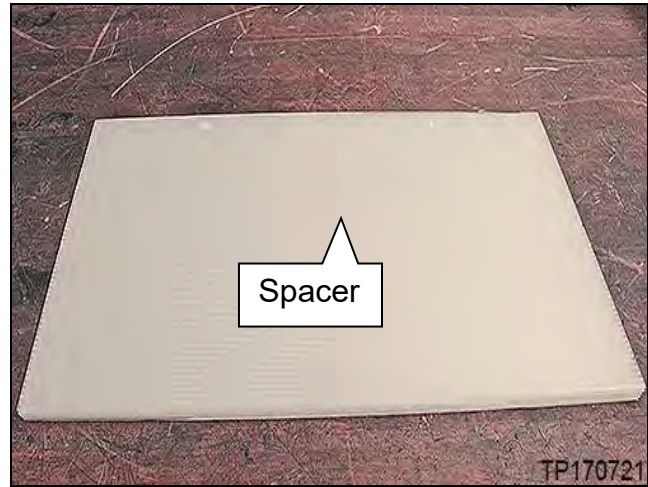

Figure 6N

- Position the lower board so that it hangs over the spacer.
- Align the lower board so that the left and right cut outs are even with the spacer.

**NOTE:** The positioning of the lower board with foam cushion will allow the CVT case enough clearance from the work bench to allow it to seat flush with the sub-assembly.

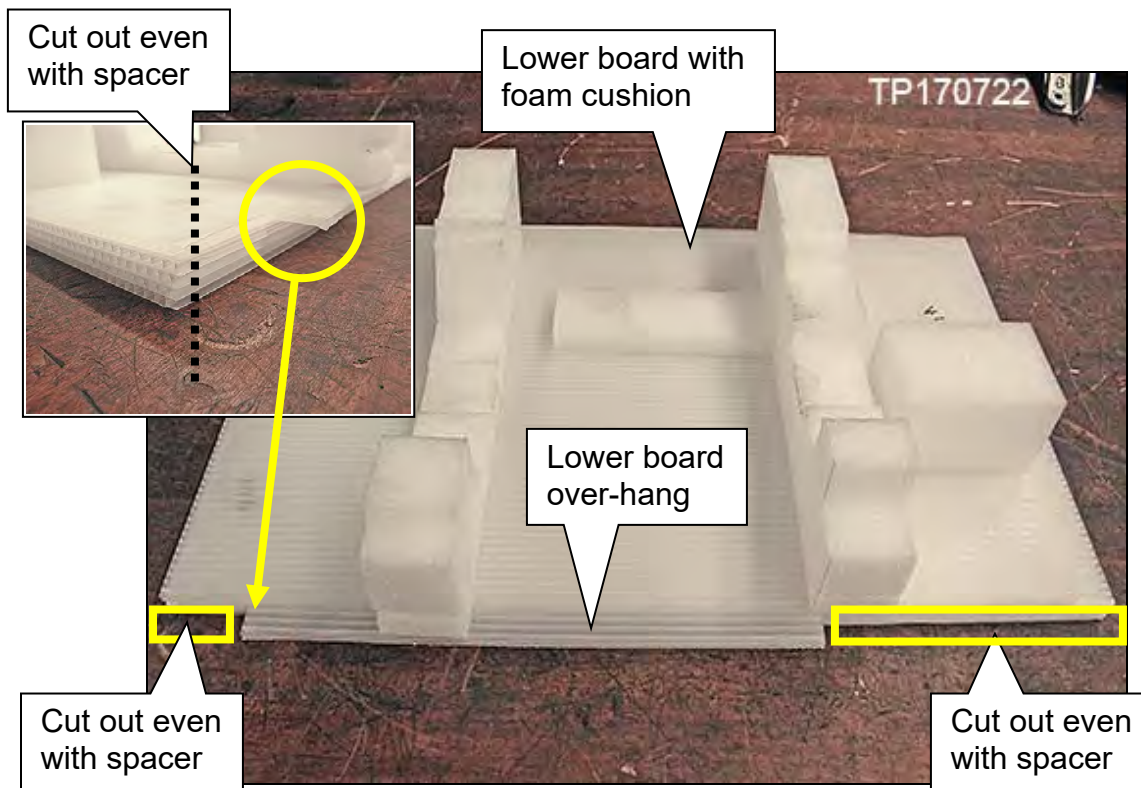
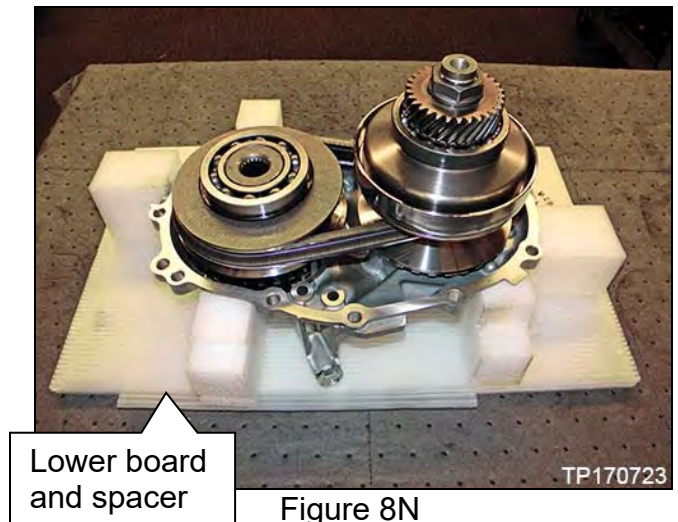

Figure 7N

8. Remove the sub-assembly from the plastic bag.

9. Place the new sub-assembly onto the lower board.

- The sub-assembly must be level and oriented as shown in Figure 8N for proper seating of the CVT case later in this procedure.



10. Remove the snap ring from the secondary pulley front bearing of the new sub-assembly.

- Discard the removed snap ring.

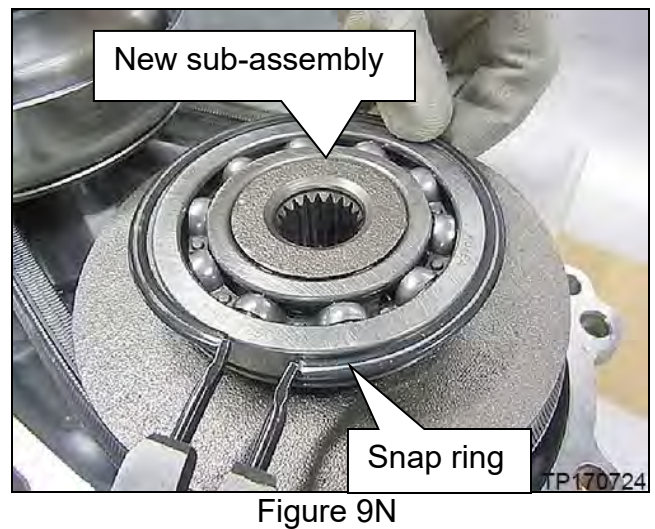

11. Calculate “E” for snap ring selection as follows:

**NOTE:** For the value of “B1”, refer to the data sheet that was put aside when the sub-assembly shipping box was opened.

- Calculated case depth from step **8c** on page 57 → **D** \_\_\_\_\_
- Subtract constant value → **− 41.30**  
-----
- Subtotal → **=** \_\_\_\_\_
- Add value for “B1” from data sheet → **+ B1** \_\_\_\_\_  
-----
- Total calculated depth → **= E** \_\_\_\_\_

**E** = This will be used to select a snap ring from Table A on page 63.

**EXAMPLE:**

**If D** = 41.39 mm  
**Constant** = 41.30 mm (subtracted)  
**And B1** = 1.56 mm (added)  
 \_\_\_\_\_  
**E** = 1.65 mm

12. Select the appropriate Part Number from Table A shown below, based on the calculated result of “E” in step 11.

**EXAMPLE:** If **E = 1.65**, and is between or equal to **1.64 to 1.67**, choose new snap ring Part Number “**31506 3JX9C**”.

E (MM)	PART NUMBER	SNAP RING REFERENCE (MM)
1.55 to 1.59	31506 3JX9A	1.61
1.60 to 1.63	31506 3JX9B	1.65
1.64 to 1.67	31506 3JX9C	1.69
1.68 to 1.71	31506 3JX9D	1.73
1.72 to 1.75	31506 3JX9E	1.77
1.76 to 1.76	31506 3JX8A	1.79

Reference only. This does not equal “E”

**Table A**

E (MM)	PART NUMBER	SNAP RING REFERENCE (MM)
1.55 to 1.59	31506 3JX9A	1.61
1.60 to 1.63	31506 3JX9B	1.65
1.64 to 1.67	31506 3JX9C	1.69
1.68 to 1.71	31506 3JX9D	1.73
1.72 to 1.75	31506 3JX9E	1.77
1.76 to 1.76	31506 3JX8A	1.79

13. Open the plastic bag (with snap rings) that was removed from the shipping box in step 4, and then choose the correct Part Number selected from Table A.

**NOTE:** There are six individually packed snap rings in the plastic bag. See **Reference # 5** in the **KIT PARTS REFERENCE TABLE**.

14. Measure the new snap ring and confirm its thickness is equal to the Snap Ring Reference in Table A.

15. Install the selected snap ring to the secondary pulley front bearing of the new sub-assembly.

**NOTE:** Discard unused snap rings.

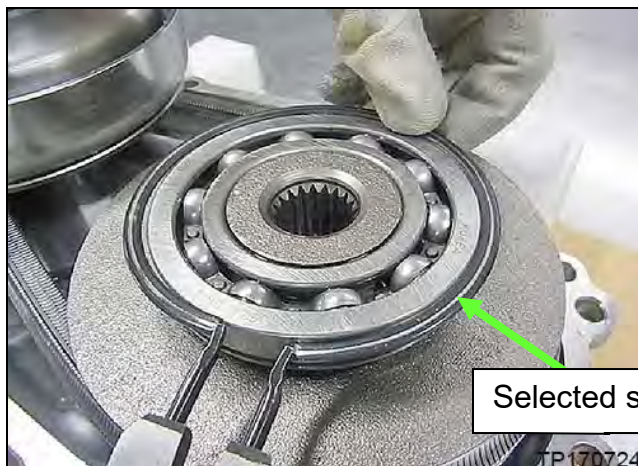

Figure 10N



Figure 11N

Selected snap ring

## Install Sub-assembly to CVT Case

1. Make sure the CVT case sealing surface of the side cover is thoroughly cleaned.
2. **Make sure the dowel pins are cleaned and any rust has been removed.**

CVT case sealing surface

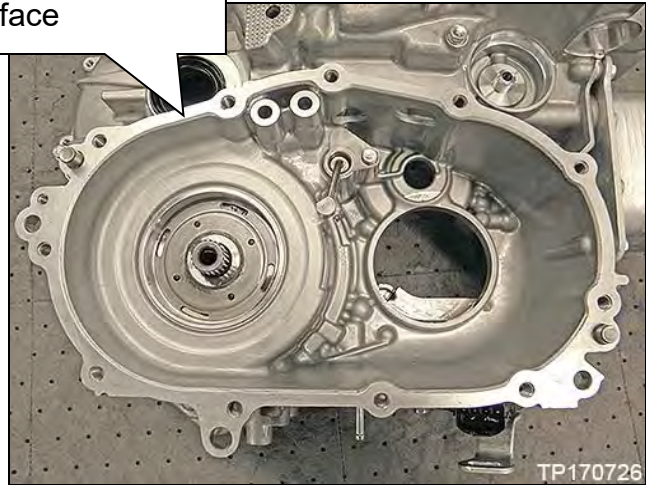

Figure 1P

3. Flip the CVT case over on the work bench with the torque converter housing side facing up.

**CAUTION:** Make sure the work bench surface is thoroughly cleaned before flipping the CVT case.

4. Remove the two (2) temporary bolts and then remove the torque converter housing from the CVT case.

- Discard these bolts.

Torque converter housing

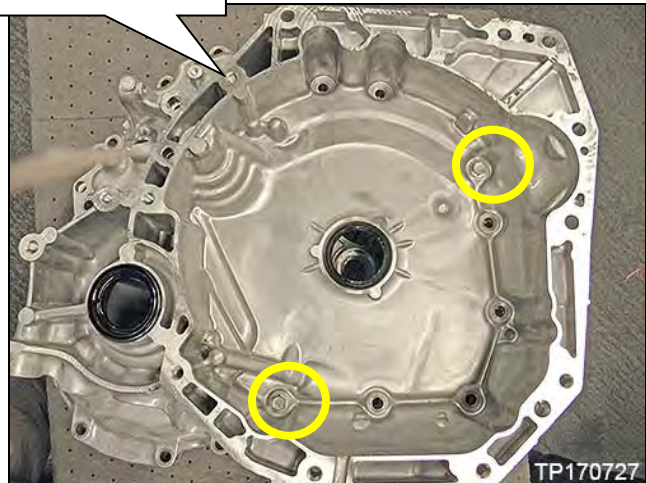

Figure 2P



5. Install the CVT case onto the new sub-assembly as follows:

**NOTE:** Sealant will be applied between these components at a later step.

- a. Slowly lower the CVT case onto the sub-assembly.

**IMPORTANT:**

- Only use the weight of the CVT case when installing it to the sub-assembly.
- Do NOT use any other external force to seat the CVT case to the sub-assembly.



- b. Align the “primary pulley front bearing bore” of the CVT case to the primary pulley front bearing of the sub-assembly.

**NOTE:** Figure 4P is shown looking down into the CVT case while it is being lowered.

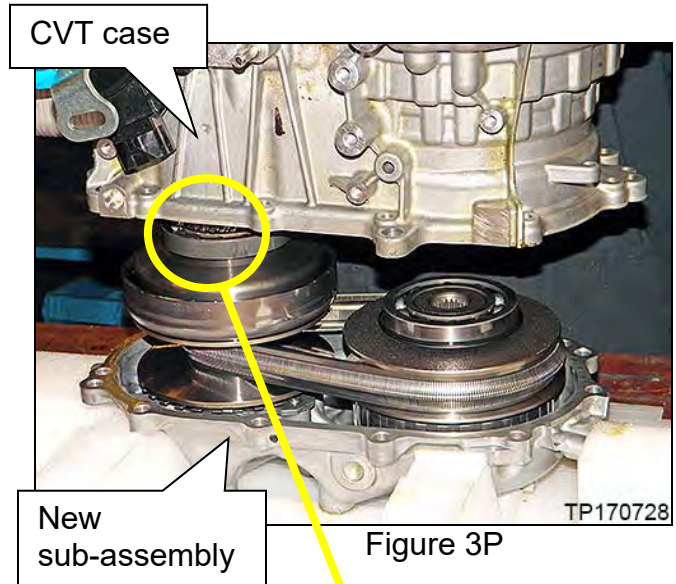

Primary pulley sub-assembly

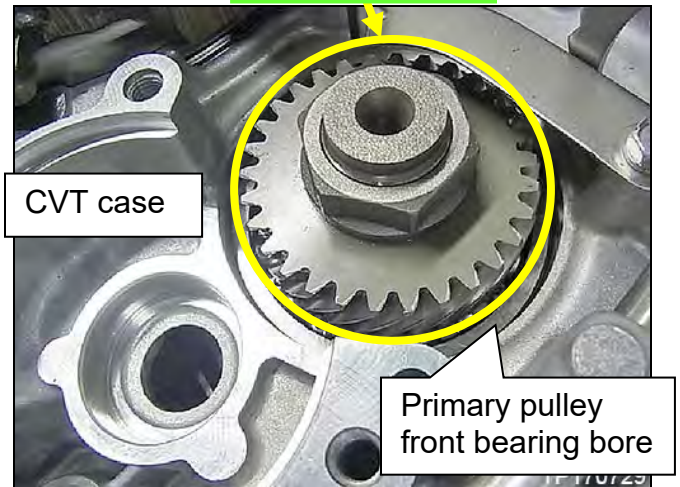

Figure 4P

- c. Align one of two dowel pin holes found on the CVT case to the sub-assembly.

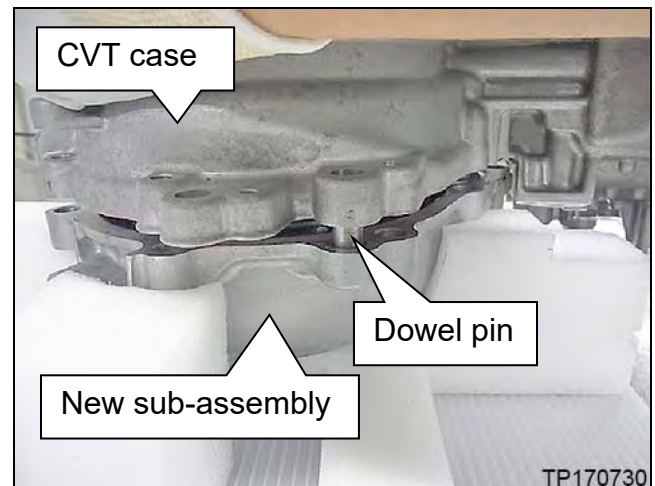

Figure 5P

- d. Align the second dowel pin of the sub-assembly with the hole on the opposite side of the CVT case and seat CVT case.

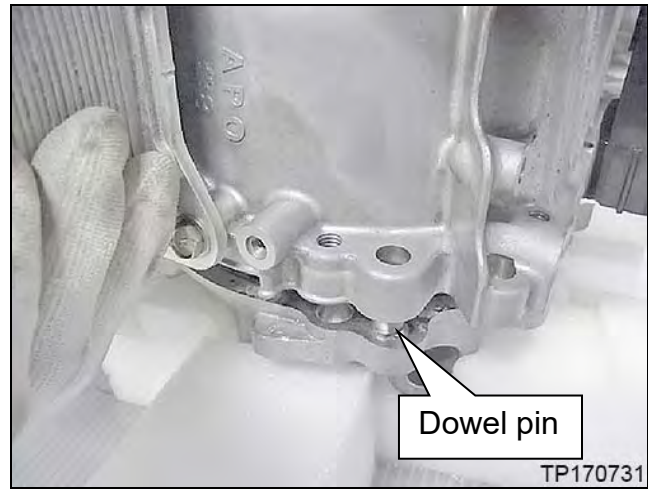

Figure 6P

- e. If the CVT case will not seat on the sub-assembly:
  - 1) Access the counter driven gear through the top of the CVT case, **and**
  - 2) Rotate the counter driven gear on the primary pulley back and forth.

**NOTE:** This will allow the splines of the secondary pulley and the planetary carrier plate to align. See Figure 8P.

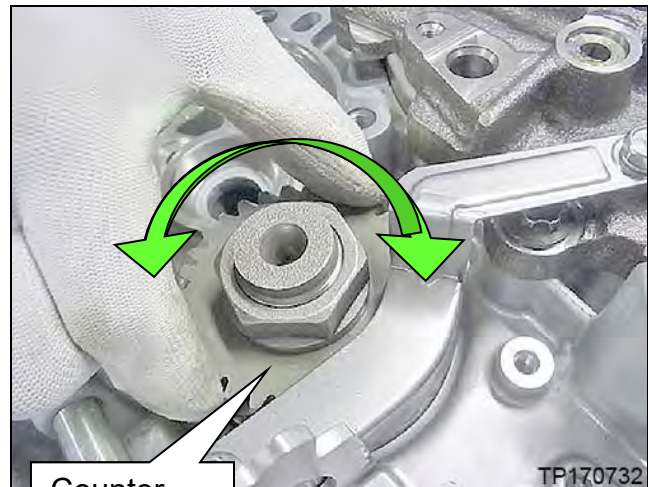

Figure 7P

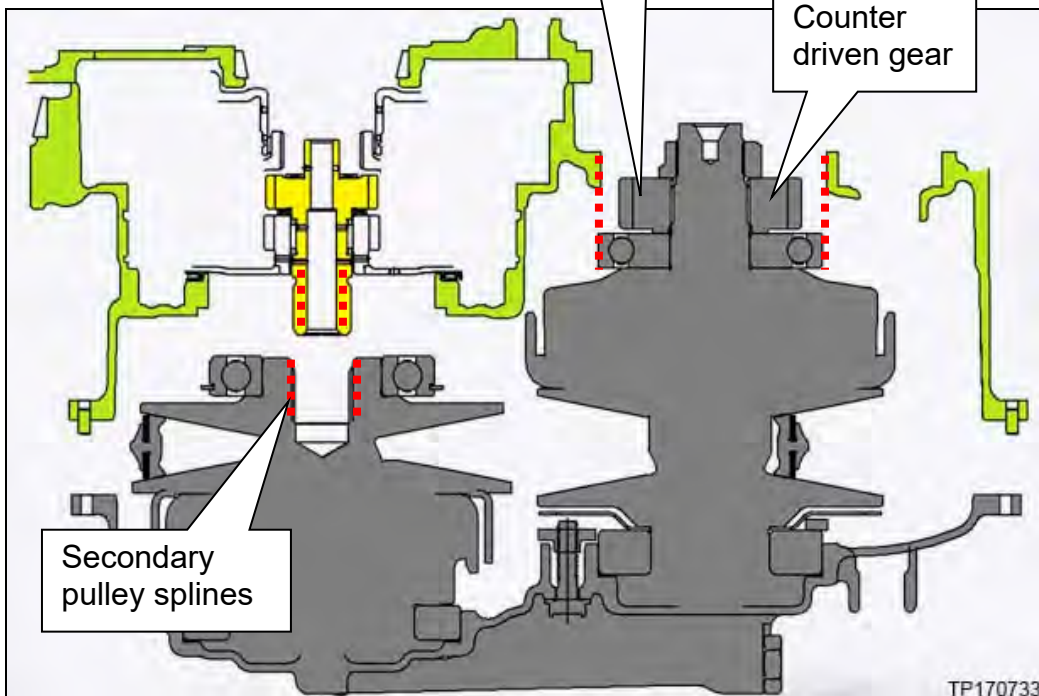

Figure 8P

- f. Confirm that the mating surface of the CVT case is seated to the sub-assembly completely.
- If the CVT case does not sit completely flush with the sub-assembly, DO NOT apply any vertical force to seat it.
    - 1) If this occurs, first lift the CVT case up slightly and then lower.
    - 2) Repeat until the CVT case and sub-assembly sit flush with each other.

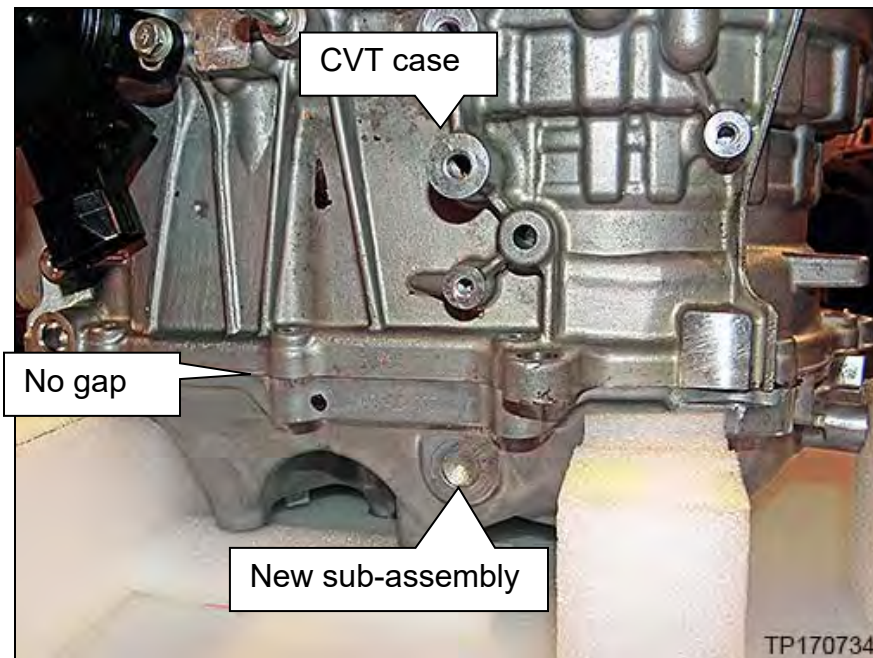

Figure 9P

- g. Rotate the counter driven gear back and forth by hand to confirm that rotation is smooth.

6. Temporarily install two (2) original bolts hand tight to hold the sub-assembly to the CVT case.

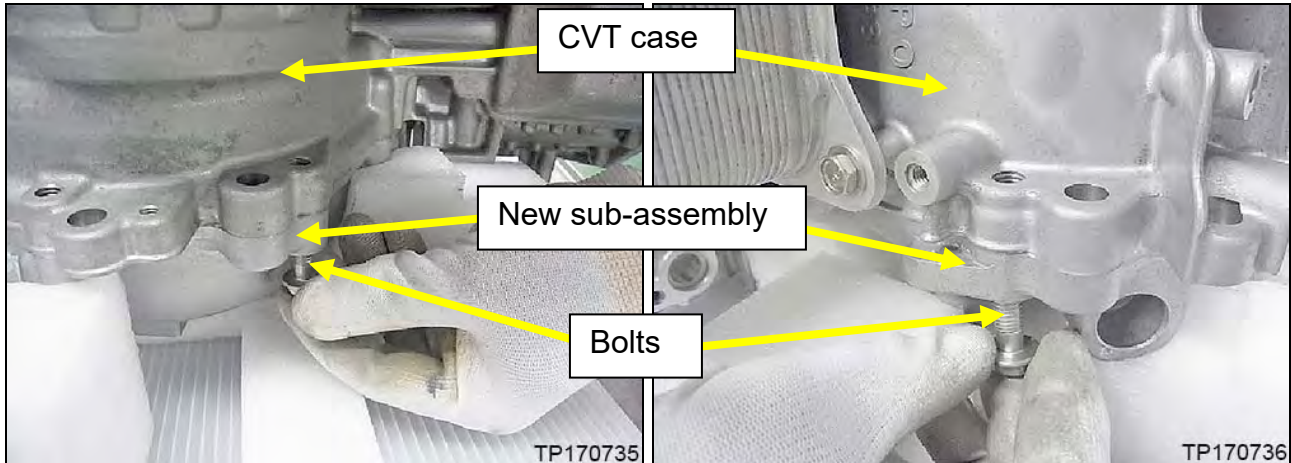
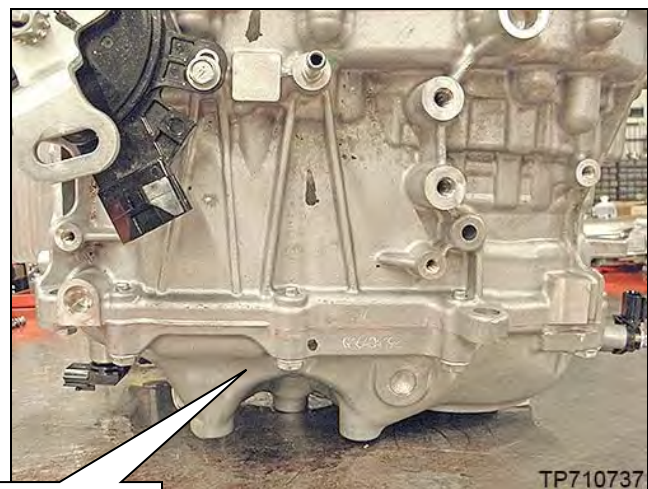

Figure 10P

Figure 11P

7. Lift the sub-assembly / CVT case away from the cradle and set aside; discard the cradle.

- Leave the sub-assembly side cover facing down as shown in Figure 12P.
- Weight: 29 kg (**64 lbs.**)



Sub-assembly side cover

Figure 12P

## Install the Oil Pump and the Manual Shaft

1. Install the oil pump gasket to the CVT case.
  - Use a new gasket (non-reusable).
  - Apply CVT Fluid before installation.

**NOTE:** See **Reference # 14** in the **KIT PARTS REFERENCE TABLE**.

2. Remove the hand tight transmission range switch bolts and then slide the manual shaft out only far enough to install the oil pump.

**CAUTION:** Do not remove the manual shaft completely from the CVT case. If the retaining pin slot contacts the seal damage may occur.

3. Install a new oil pump to the CVT case.
  - Reuse the three original Allen bolts for the oil pump.
  - 35 mm (**1.4 inches**) long bolt.
    - Bolt torque:  
20.3 N•m (2.1 kg-m, **15 ft-lbs.**)

**NOTE:** See **Reference # 13** in the **KIT PARTS REFERENCE TABLE**.

4. Install the snap ring that came out of the original oil pump to the new oil pump.

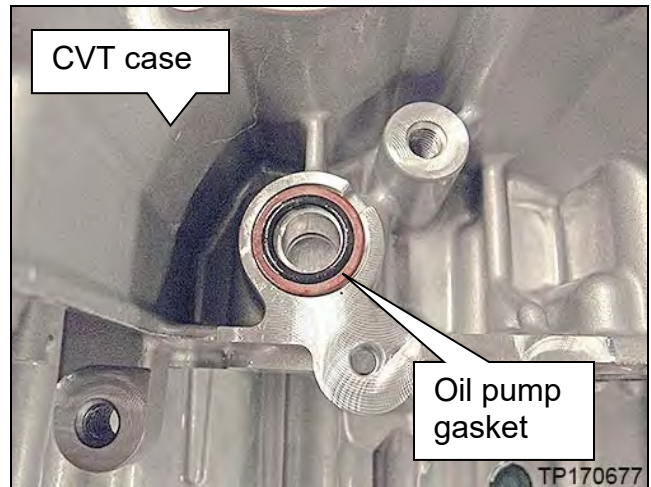

Figure 1Q

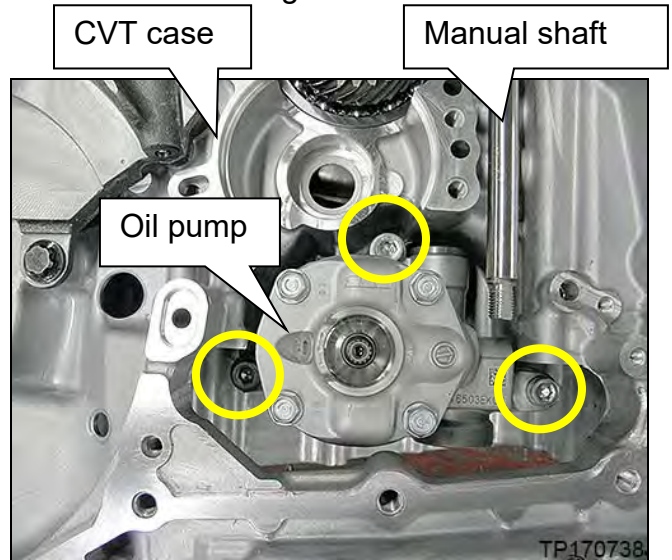

Figure 2Q

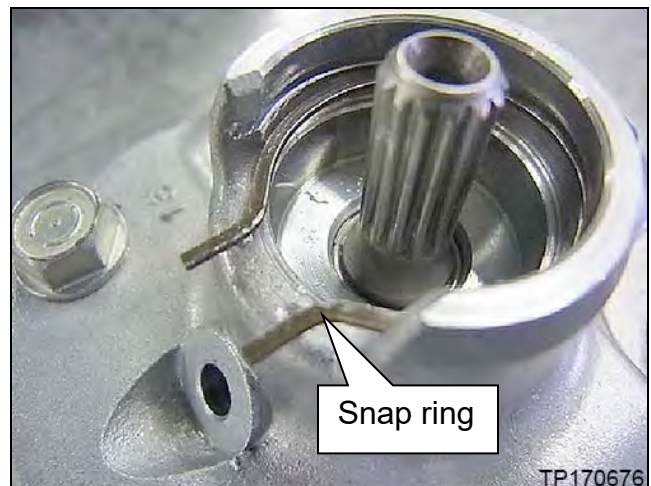

Figure 3Q

5. Slide the manual shaft back to the original position.

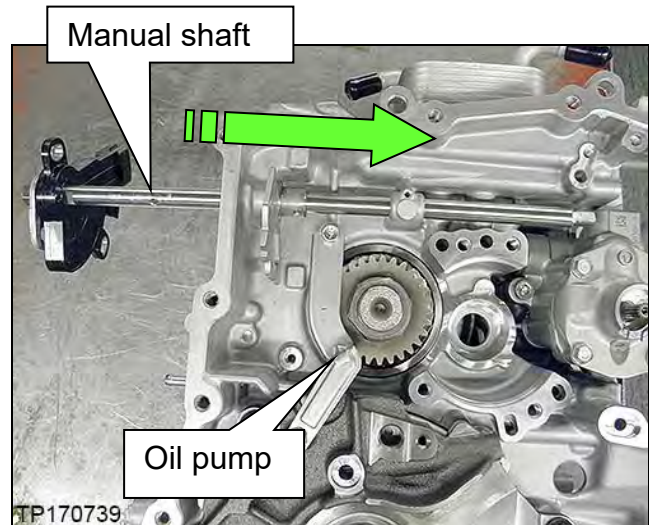

Figure 4Q

6. Install the original retaining pin as shown in Figure 5Q.
- Align the manual shaft groove (Figure 6Q) to allow the retaining pin (Figure 5Q) to go through completely.

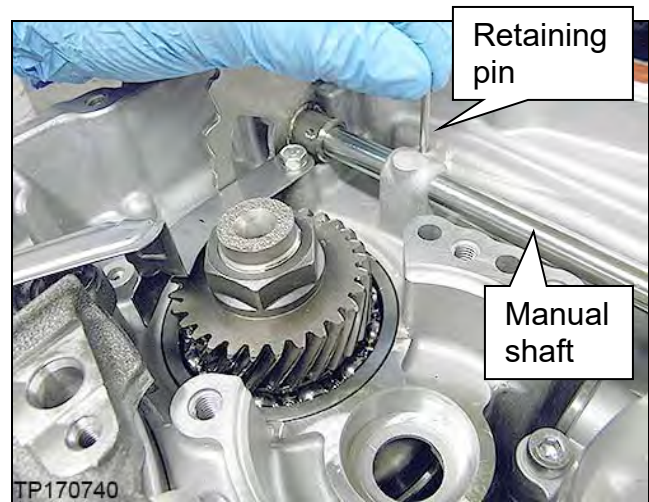

Figure 5Q

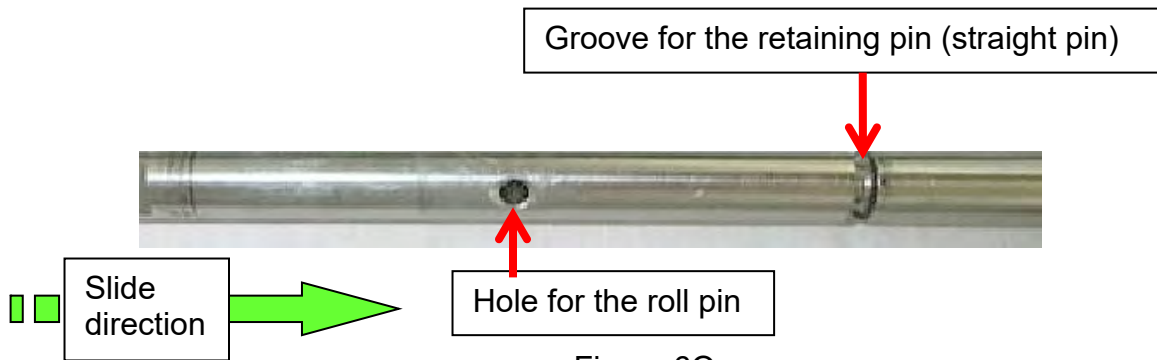

Figure 6Q

**IMPORTANT:**

In the following step:

- Do not drive the roll pin flush with the detent plate.
- If the roll pin is driven flush, it will be overextended on the opposite side and the manual shaft/detent plate assembly will not rotate.
- The roll pin MUST be the same length on both sides of the detent plate after it is installed through the detent plate and manual shaft.

7. Install the new roll pin through the detent plate and manual shaft.

- The roll pin must be inserted through the detent plate so that both ends are the same length.
- Use a new roll pin (non-reusable).
- Punch size: Diameter 3 mm, Length 20 mm or longer.

**CAUTION:** Use the appropriate size punch to prevent damage to the roll pin or detent plate.

**NOTE:** See **Reference # 12** in the **KIT PARTS REFERENCE TABLE**.

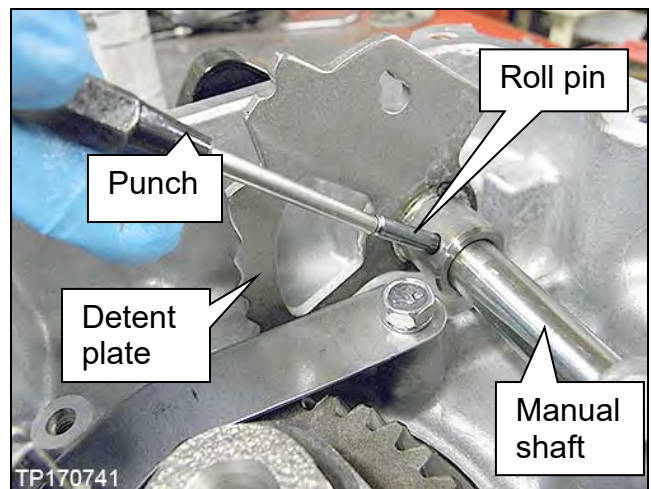

Figure 7Q

## Install Powertrain Parts

1. Install the original manual shaft detent spring to the CVT case.

**IMPORTANT:** Locate the tab of the detent spring to the hole of the CVT case.

- 16 mm (**0.6 inch**) long bolt.
  - Bolt torque:  
6.8 N•m (0.70 kg-m, **60 in-lbs.**)

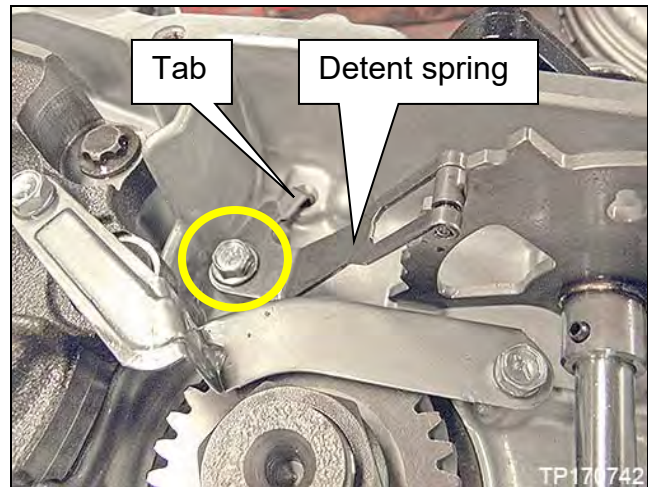

Figure 1R

2. Install the original shim for the input shaft in the counter bearing bore.

**NOTE:** See page 37.

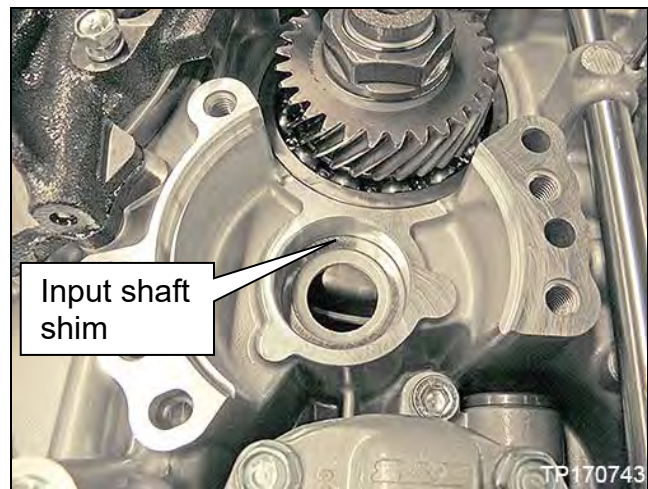

Figure 2R

3. If the counter bearing is a type "B" or "C" (ball bearing) skip to step 6 on page 73.

**NOTE:** Type "B" counter bearing shown in Figure 3R. Type "A" is similar.



Figure 3R



4. If the counter bearing is a type “A” (roller bearing):

- If not already done, install the outer race of the roller bearing to the counter bearing bore of the CVT case.

**IMPORTANT:** Apply CVT Fluid to the outer race of the roller bearing before installation.

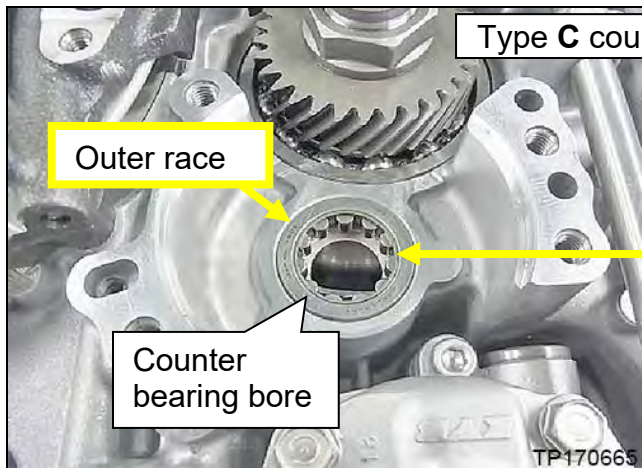

Figure 4R

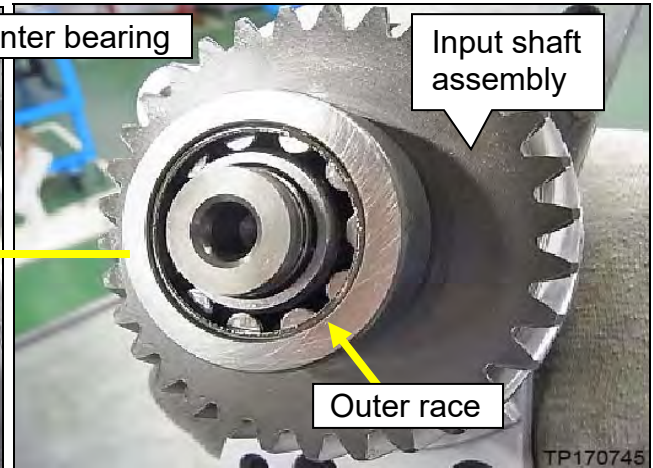

Figure 5R

5. If the input shaft assembly is, for any reason, separated into individual components, see steps 8e-8g on pages 53-54 to reassemble those parts.

6. Install the input shaft assembly to the CVT case

- Hold the tip of the input shaft so that the input shaft and the pump cover remain together.
- Confirm that the oil pump cover seats onto the CVT case completely.

**CAUTION:** Do not draw the input shaft assembly down to the case with the mounting bolts.

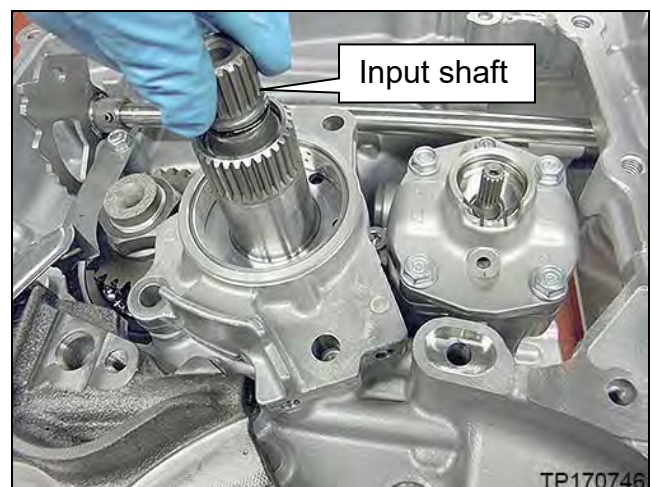

Figure 6R

7. Install the original chain cover and the six (6) original bolts and then tighten.

- 16 mm (**0.6 inches**) long bolt  
2 pieces.
  - Bolt torque:  
5.6 N•m (0.60 kg-m, **50 in-lbs.**)
- 30 mm (**1.2 inches**) long bolt  
4 pieces.
  - Bolt torque:  
27.1 N•m (2.8 kg-m, **20 ft-lbs.**)

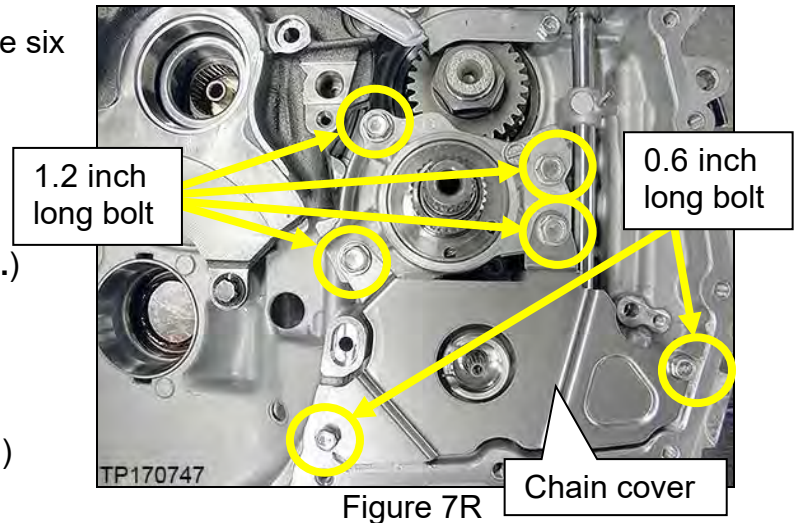

Figure 7R

8. Rotate the input shaft by hand to confirm that the shaft rotates freely.

9. Install the sleeve to the reverse brake tube.

- Use a new sleeve (non-reusable).
- Apply CVT Fluid to the sleeve before installation.

**NOTE:** See **Reference # 20** in the **KIT PARTS REFERENCE TABLE**.

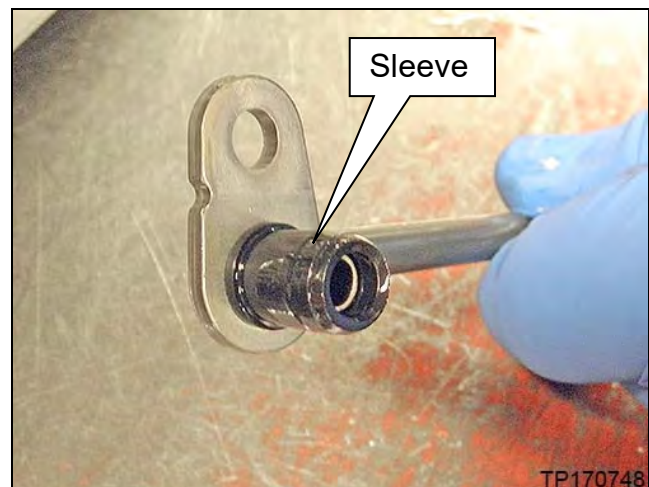

Figure 8R

10. Install the reverse brake tube to the CVT case.

- 16 mm (**0.6 inches**) long bolt.
  - Bolt torque:  
5.6 N•m (0.60 kg-m, **50 in-lbs.**)

**CAUTION:** Insert the tube to the CVT case vertically and evenly to avoid damages to the sleeve.

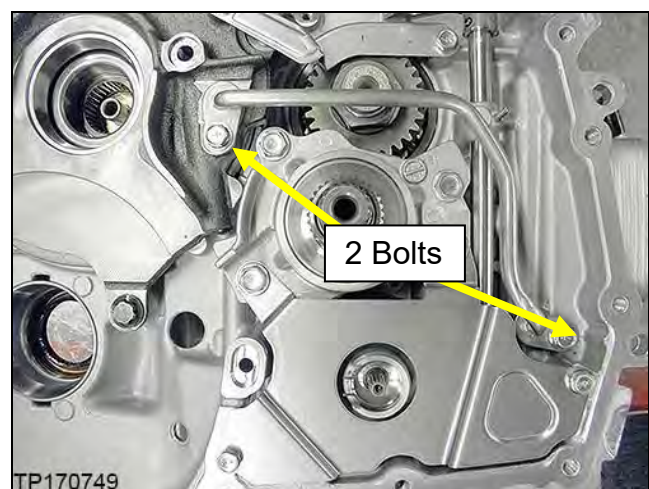

Figure 9R

11. Connect the parking rod to the detent plate as shown in Figure 10R.

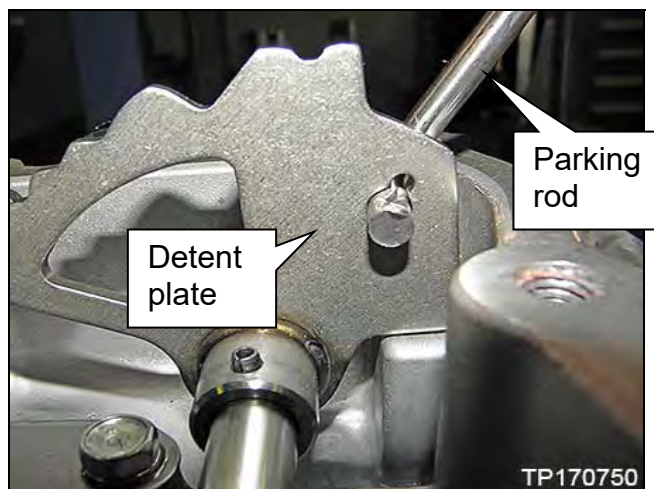

Figure 10R

12. Rotate the detent plate until the detent is in the "D" position (see Figure 11R).

- The detent spring position shall be on the second left concave of the detent plate.

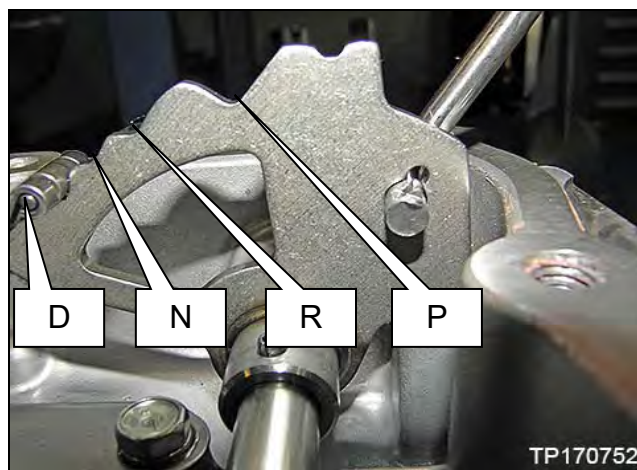
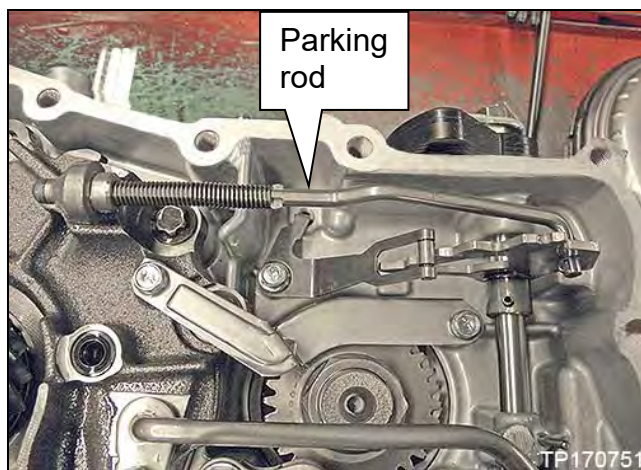

Figure 11R

13. Install the oil pump chain onto the oil pump sprocket and the drive sprocket and then lower onto the oil pump shaft (driven sprocket) (Figure 12R).
14. Expand the snap ring with a suitable tool (Figure 12R), and then push down on the driven sprocket until it bottoms out.
15. Release the snap ring and then pull up on the driven sprocket until the snap ring locks into its groove (Figure 12R).

**NOTE:** A click sound can be heard when the snap ring locks in place.

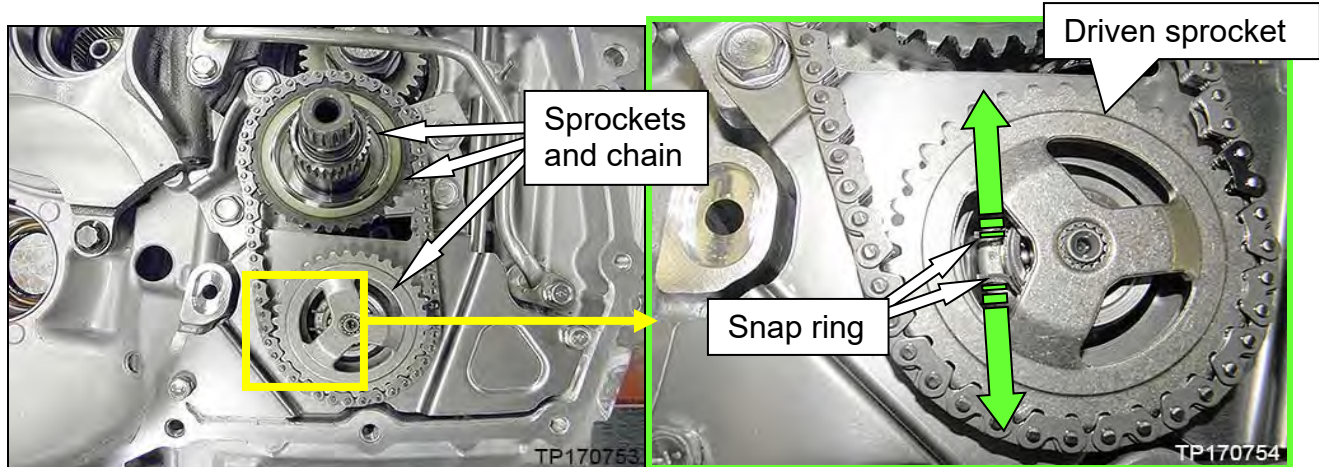

Figure 12R

16. Install the original thrust bearing onto the drive sprocket.

**IMPORTANT:** Install the thrust bearing with the exposed bearings facing up.

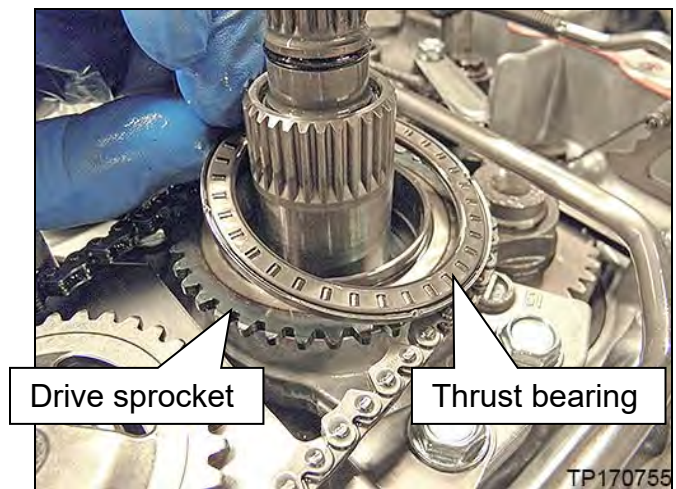

Figure 13R

17. Rotate the input shaft by hand to confirm that the chain, pump and shaft rotate freely.

18. Install the new O-ring onto the input shaft.

- Use a new O-ring (non-reusable).
- Apply CVT Fluid to the O-ring before installation.

**NOTE:** See Reference # 7 in the KIT PARTS REFERENCE TABLE.



Figure 14R

19. Install the CVT case O-ring (oval O-ring) to the CVT case.

- Use a new oval O-ring (non-reusable).
- Apply CVT Fluid to the O-ring before installation.

**NOTE:** See **Reference # 11** in the **KIT PARTS REFERENCE TABLE**.

20. Install the lip seal to the CVT case.

- Use a new lip seal (non-reusable).
- Apply CVT Fluid to the lip seal before installation.

**NOTE:** See **Reference # 10** in the **KIT PARTS REFERENCE TABLE**.

21. Confirm that both seals are seated in their grooves.

- Use petroleum jelly to help hold the seals in place.

22. Replace the two machine cut seals (Ring Seals) of the reduction gear assembly, shown in Figure 17R as follows:

- a. Clean any debris out of the machined grooves that the two Ring Seals will be installed into.

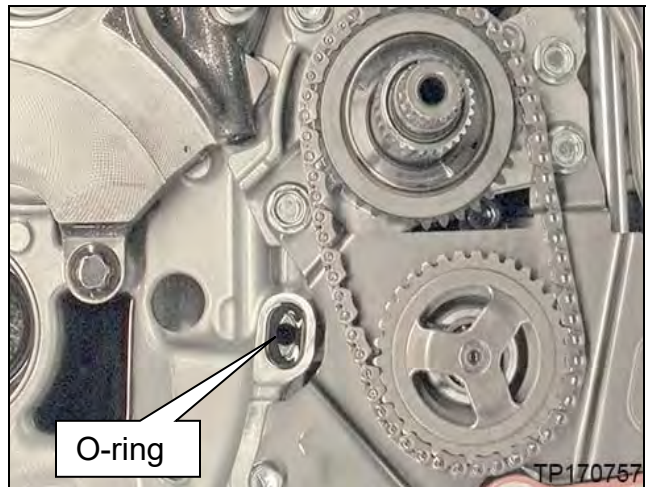

Figure 15R

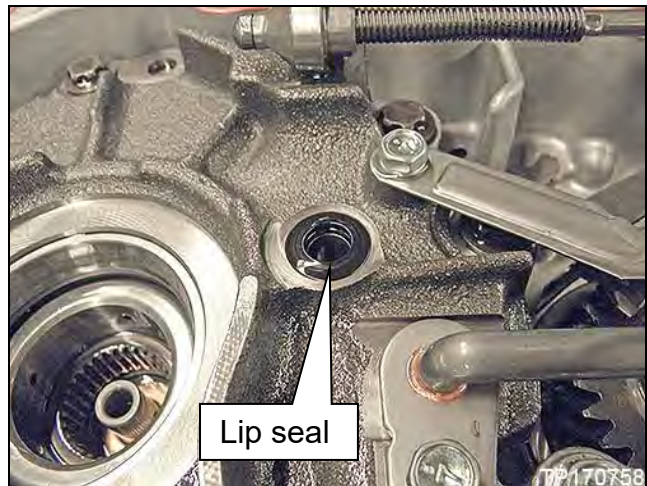

Figure 16R

**CAUTION:** These seals are **VERY** delicate. Handle with care.

**NOTE:** See **Reference # 21** in the **KIT PARTS REFERENCE TABLE**.

- Machine cut seals can be ordered in packs of 50. See part number in kit parts reference table.

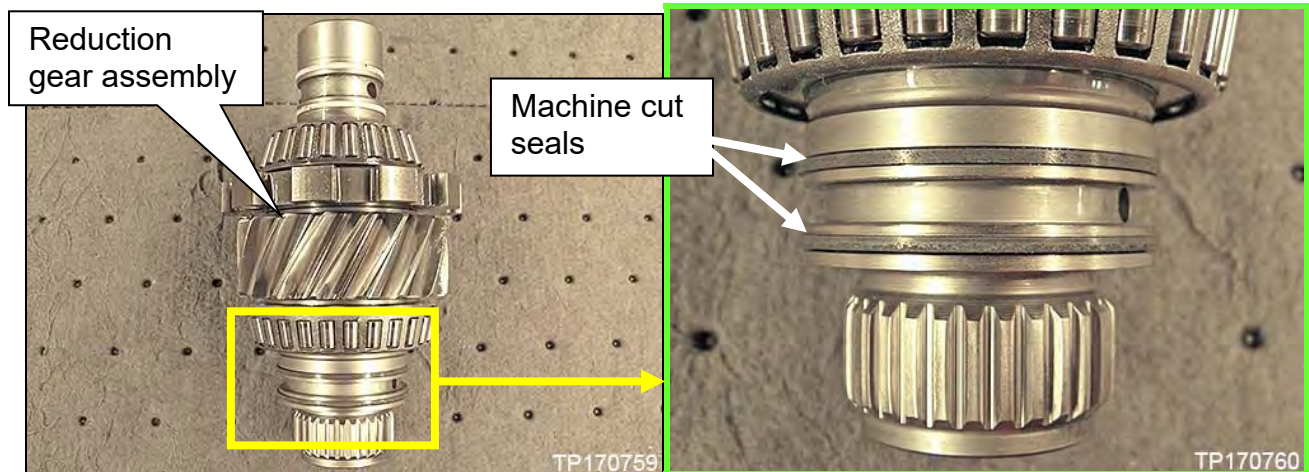

Figure 17R

- b. Pre-lube both machined grooves with CVT fluid.
- c. Slide the First Groove Seal Tool (#J-52595-1) over the reduction gear shaft.
- d. Confirm that it is completely seated.

First Groove Seal Tool (#J-52595-1)



Reduction gear assembly

Figure 18R

TP180740

- e. Pre-lube both Ring Seals with CVT fluid.

- f. Place one (1) Ring Seal onto the First Groove Seal Tool.
- g. Slide the Seal Driver (#J-52595-3) over the First Groove Seal Tool.
- h. Gently push the Ring Seal onto the first groove.

Seal Driver (#J-52595-3)

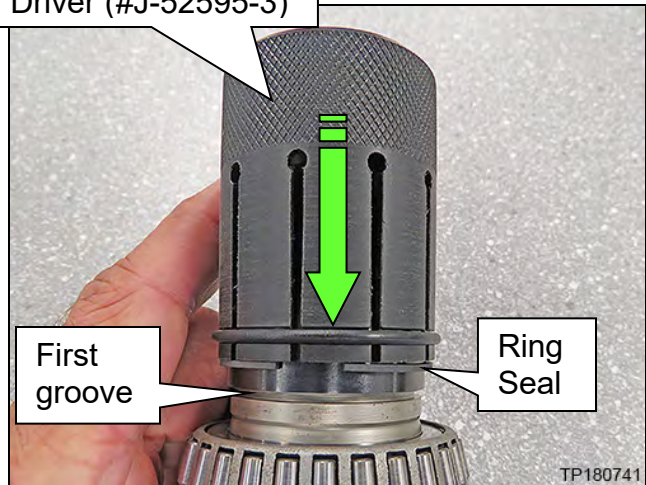

First groove

Ring Seal

Figure 19R

TP180741

- i. Remove the First Groove Seal Tool.

- j. Slide the Second Groove Seal Tool (#J-52595-2) over the reduction gear shaft.
  - Confirm that it is completely seated.

Second Groove Seal Tool (#J-52595-2)

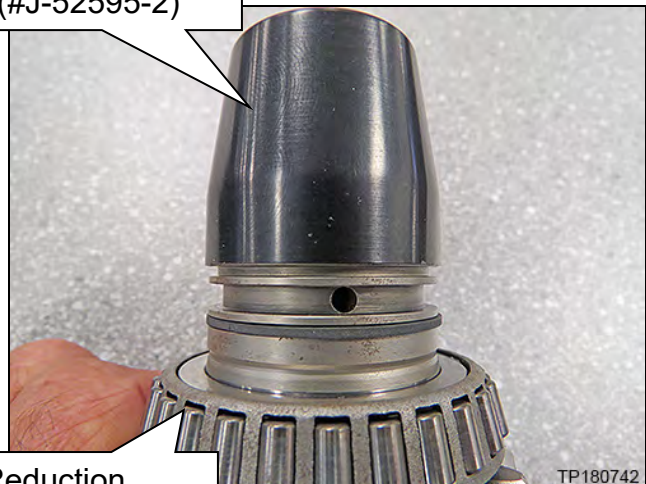

Reduction gear assembly

Figure 20R

TP180742

- k. Place one (1) Ring Seal onto the Second Groove Seal Tool.
- l. Slide the Seal Driver (#J-52595-3) over the Second Groove Seal Tool.
- m. Gently push the Ring Seal onto the second groove.
- n. Remove the Second Groove Seal Tool.

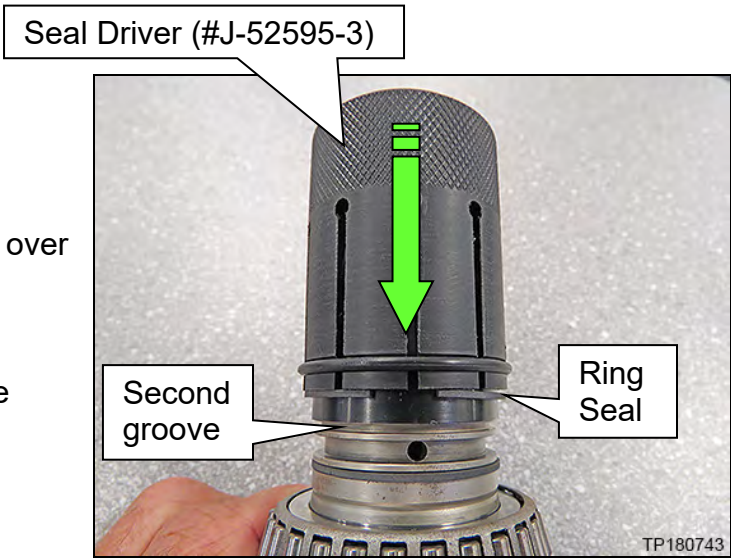

Figure 21R

- Confirm that both of the Ring Seals are not protruding in any direction.

**NOTE:** If the reduction gear shaft is not going to be immediately installed, the Split Ring Seal Cover (#J-52595-4) can be slid over both Ring Seals to prevent damage.

**CAUTION:** in the following step use extreme care when installing the final drive and reduction gear assembly.

- The machine cut seals are VERY delicate and will damage easily if forced.
- The reduction gear assembly should seat without any additional force.
- If the reduction gear assembly does not seat, remove it and confirm that machine cut seals are in place and centered in their grooves.

- 23. Confirm that the thrust bearing is in place in the bottom of the reduction gear assembly bore.

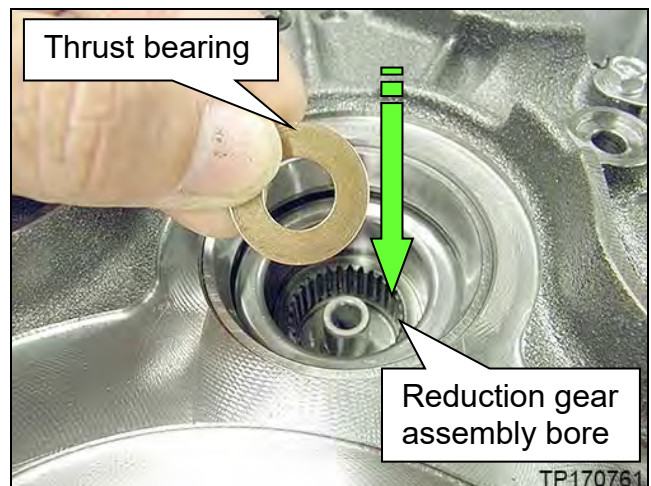

Figure 22R

24. Install the final drive and reduction gear assembly together into the CVT case.

- If the reduction gear assembly does not seat, remove it and confirm that machine cut seals are in place and centered in their grooves.

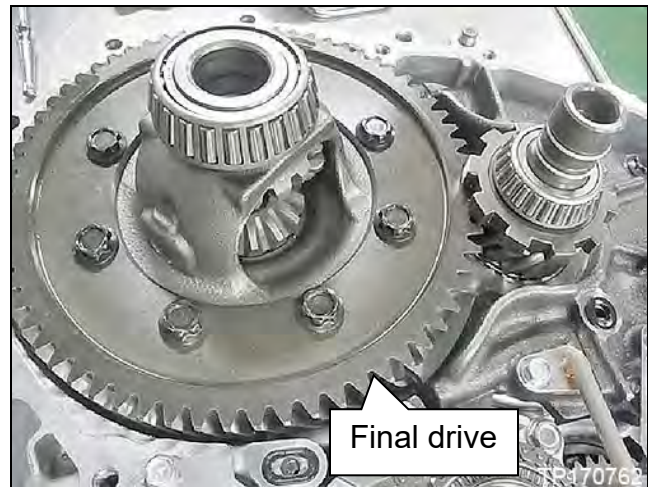

Figure 23R

25. Rotate the final drive by hand to confirm that it rotates freely.

### Install the Torque Converter Housing

1. Place the original thrust washer on the torque converter housing.
  - Apply petroleum jelly to the mating surface side of the washer to hold the washer on the converter housing.

**NOTE:** Both sides of the thrust washer are the same, orientation is not critical.



Figure 1S

2. Remove any remaining CVT fluid on the sealing surfaces of the torque converter housing and the CVT case.

**NOTE:** Brake cleaner is acceptable to remove remaining CVT fluid.

**CAUTION:** Avoid any debris from dropping into the torque converter housing or the CVT case.



3. Apply sealant to the CVT case side of the torque converter housing to CVT case mating surface.

- Sealant bead diameter: 2.0 mm

**Sealant:**

- Loctite 5460 (See the Parts Information section of this bulletin)
- Color: Pink

**IMPORTANT:**

- Confirm that the mating surfaces are clean before applying sealant.
- Make sure that the starting point and the ending point of the sealant is between two bolt holes. Overlap both ends of the bead by 3 – 5 mm.
- If the Guide Pins were removed to clean the case surfaces, reinstall them now.

**CAUTION:** Be careful not to contact or contaminate the sealant. If the sealant has been disturbed or contaminated in any way before case assembly, remove the sealant completely and re-apply.

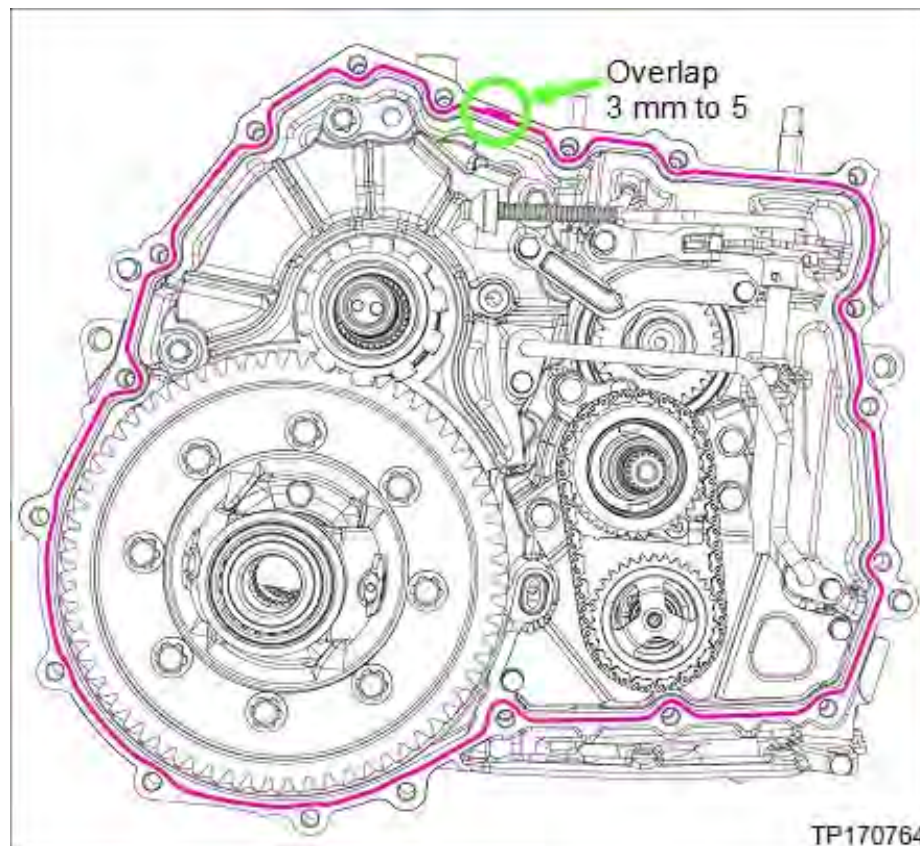

Figure 2S

4. Install the torque converter housing onto the CVT case with nineteen (19) new bolts and torque to the pattern shown in Figure 3S.

**NOTE:** If the torque converter housing does not fully seat, the CVT may not be in DRIVE.

- Use new bolts.

**NOTE:** See **Reference # 9** in the **KIT PARTS REFERENCE TABLE**.

- Bolt torque: 27.1 N•m (2.8 kg-m, **20 ft-lbs.**)

**IMPORTANT:** Tighten the bolts in specific order shown below.

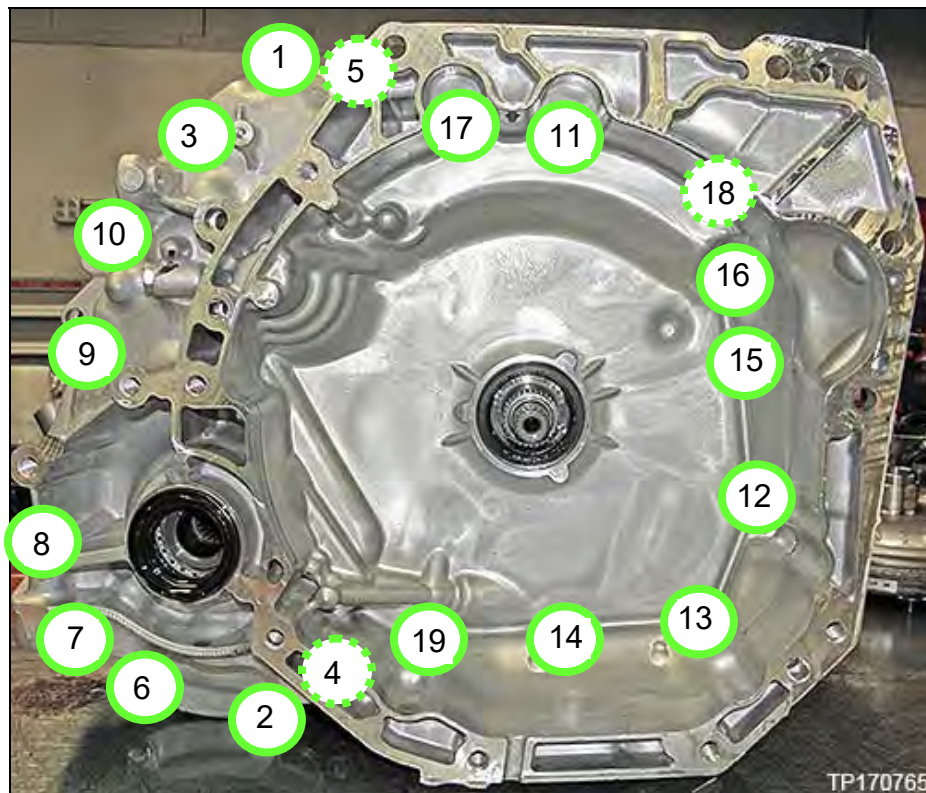

Figure 3S

## Install the Valve Body and Oil Pan

1. Rotate the CVT assembly so that the torque converter housing side is facing down.
2. Make sure that the terminal assembly is attached to the bracket of the new valve body (Figure 1T).

### NOTE:

- Apply CVT Fluid to the O-ring of the terminal connector.
- See **Reference # 1** in the **KIT PARTS REFERENCE**.

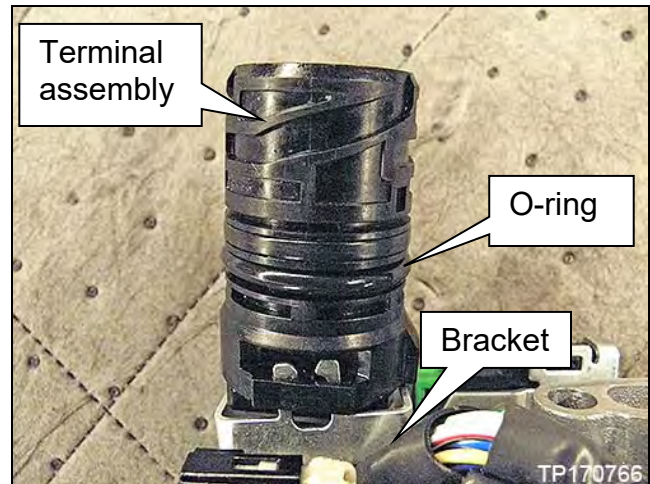

Figure 1T

3. Install the new valve body assembly to the CVT case.
  - Insert the terminal assembly through the hole of the CVT case, and then push the new valve body horizontally with even pressure to seat the valve body completely.

**NOTE:** A clicking sound may be heard as the new valve body is seated to the CVT case.



Figure 2T

4. First tighten all eleven (11) original valve body bolts finger tight by hand, and then tighten to the specified bolt torque below.

**CAUTION:** These bolts are easily stripped. Use care to not over-torque.

- 87 mm (**3.4 inches**) long bolt.  
11 pieces
  - Bolt torque:  
7.9 N•m, (0.80 kg-m, **70 in-lbs.**)

**CAUTION:** Manual valve may slide down and interfere with CVT case.

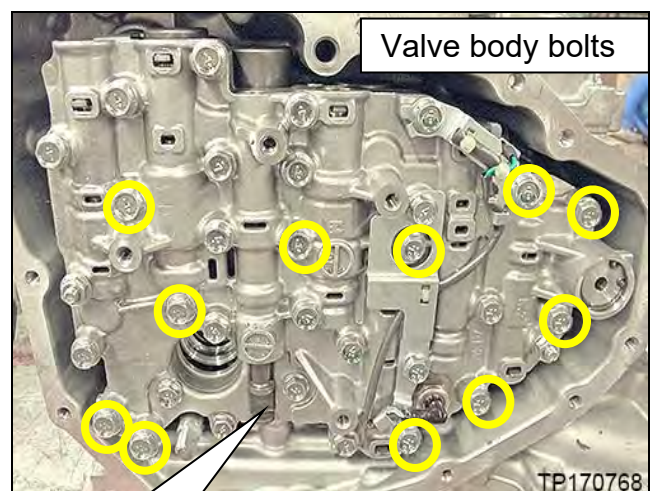

Figure 3T

5. Install the original manual plate to the manual shaft with the original spring washer and lock nut.
  - Use a crescent wrench on the transmission range switch side of the manual rod to keep the shaft from rotating while torqueing.
  - Nut torque:  
21.7 N•m (2.2 kg-m, **16 ft-lbs.**)

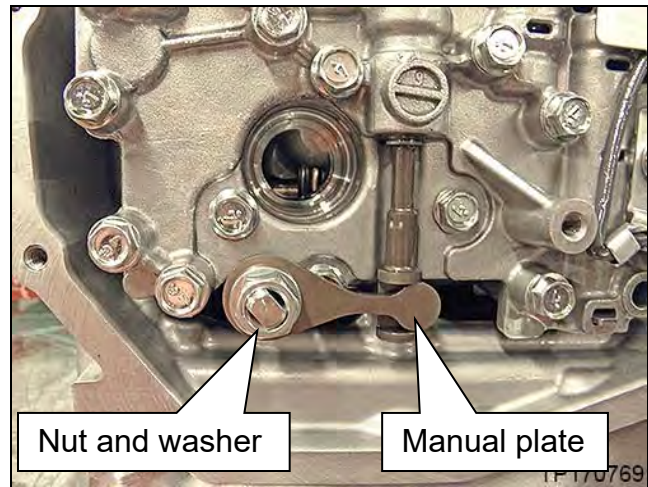

Figure 4T

6. Confirm that the new O-ring is on the new oil strainer.
  - Apply CVT Fluid to the O-ring before installation.

**NOTE:**

- The new oil strainer comes with a new O-ring.
- See **Reference # 3** in the **KIT PARTS REFERENCE TABLE**.



Figure 5T

7. Install the new strainer to the valve body with the three (3) original bolts.
  - 12 mm (**0.5 inches**) long bolt.  
3 pieces
    - Bolt torque:  
7.9 N•m (0.80 kg-m, **70 in-lbs.**)

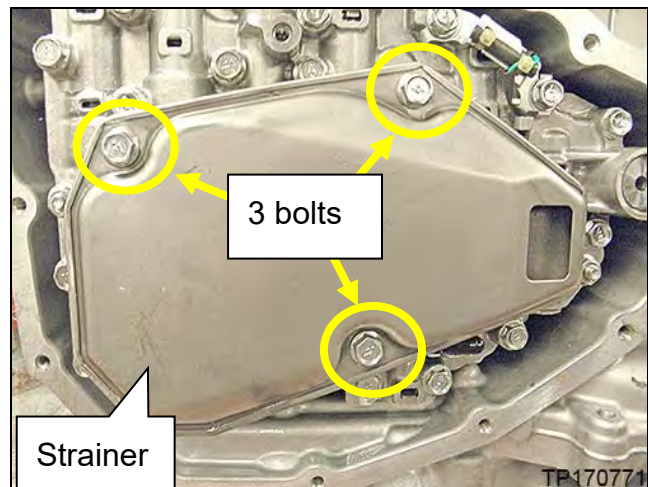

Figure 6T

8. Install the original oil pan with a new oil pan gasket using the original bolts.

- Bolt torque:  
5.6 N•m (0.60 kg-m, **50 in-lbs.**)

**NOTE:** See **Reference # 2** in the **KIT PARTS REFERENCE TABLE**.



Figure 7T

## Seal the Sub-assembly Cover

1. Confirm the torque converter housing side is facing down.
2. Remove the two temporary side cover bolts.

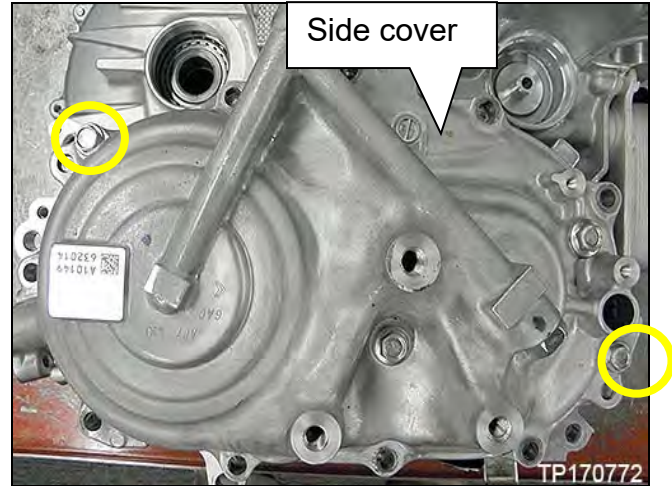

Figure 1U

3. Remove the two pulley bearing retainer bolts.
  - These bolts will be reused later in this procedure.

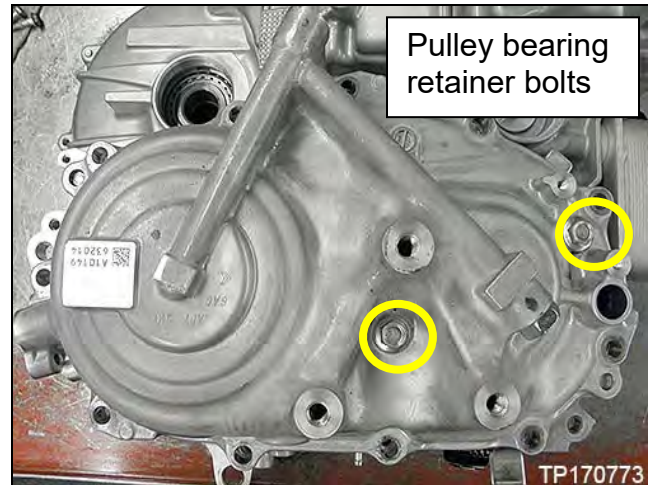

Figure 2U

4. Remove the side cover.
  - Use a slide hammer (J-25721-A) if needed.
  - There are three slide hammer tool locations on the side cover.

**NOTE:** Figure 3U shown with side cover removed.



Figure 3U

5. Install the original lubrication tube into the CVT case.

- Place the fluid jet nozzle under the CVT belt and then insert the lubrication tube into the CVT case.

**CAUTION:** Take care not to contact the CVT belt with any tools during tube installation.

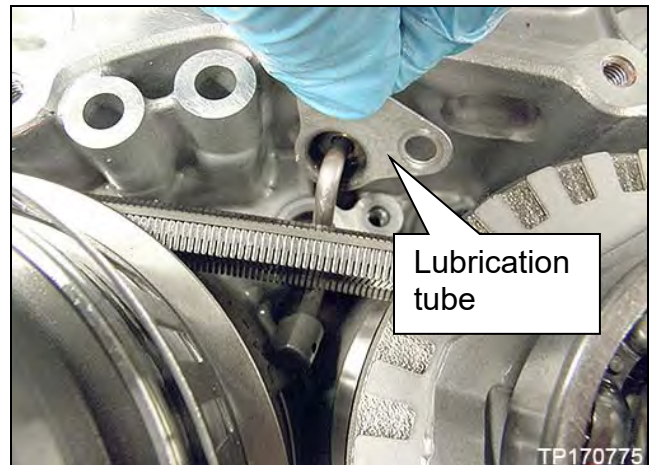

Figure 4U

6. Install the original lubrication tube bolt.

- 16 mm (0.6 inch) long bolt.
  - Bolt torque:  
6.8 N•m (0.70 kg-m, **60 in-lb**)

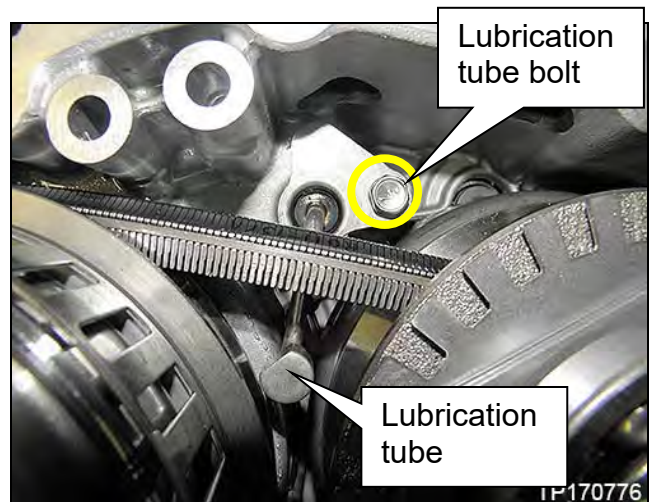

Figure 5U

7. Apply sealant to the side cover sealing surface of the CVT case.

- Sealant bead diameter: 2.0 mm

**Sealant:**

- Loctite 5460 (See the Parts Information section of this bulletin)
- Color: Pink

**IMPORTANT:**

- Confirm that the mating surfaces are clean before applying sealant.
- Make sure that the starting point and the ending point of the sealant is between two bolt holes. Overlap both ends of the bead by 3 – 5 mm.

**CAUTION:** Be careful not to contact or contaminate the sealant. If the sealant has been disturbed or contaminated in any way before side cover assembly is installed, remove the sealant completely and re-apply.

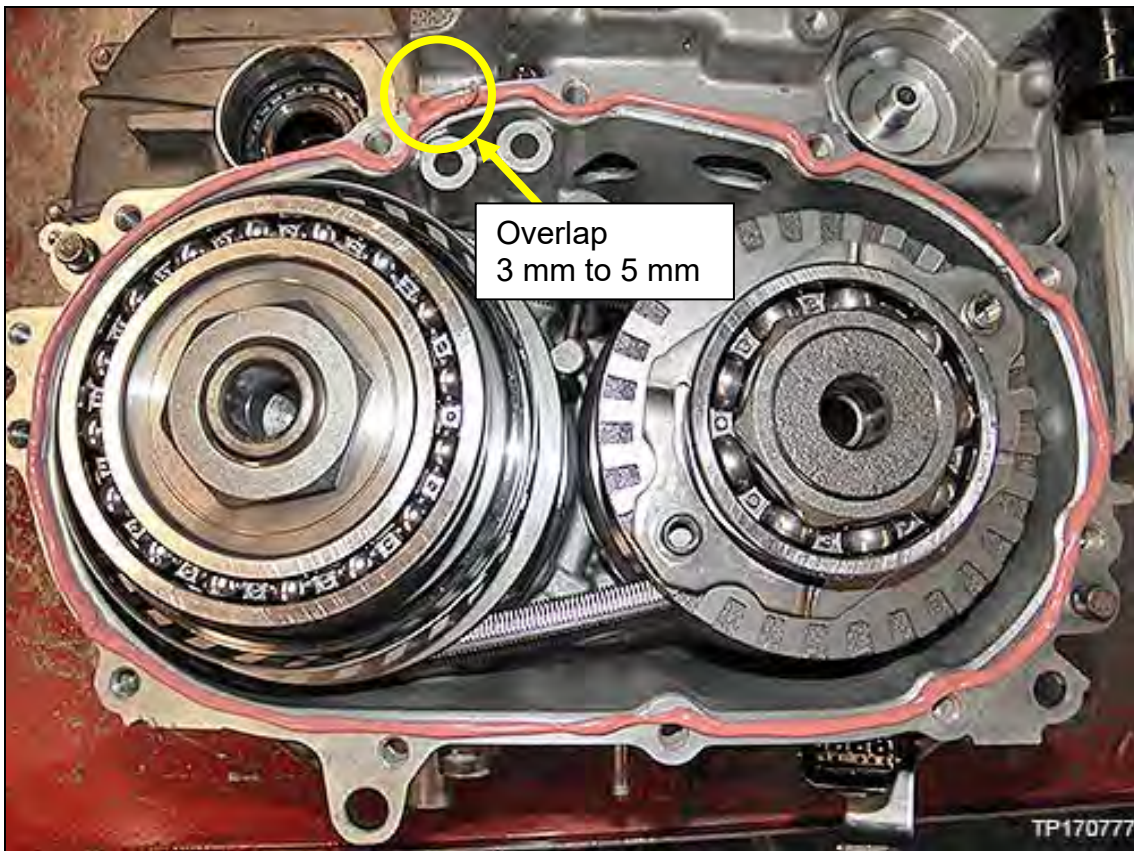

Figure 6U



8. Screw in Guide Pin (J-52272) to either one of two female bolt threads of the pulley bearing retainer.
  - Place the guide pin next to the case bolt hole as shown in Figure 7U.

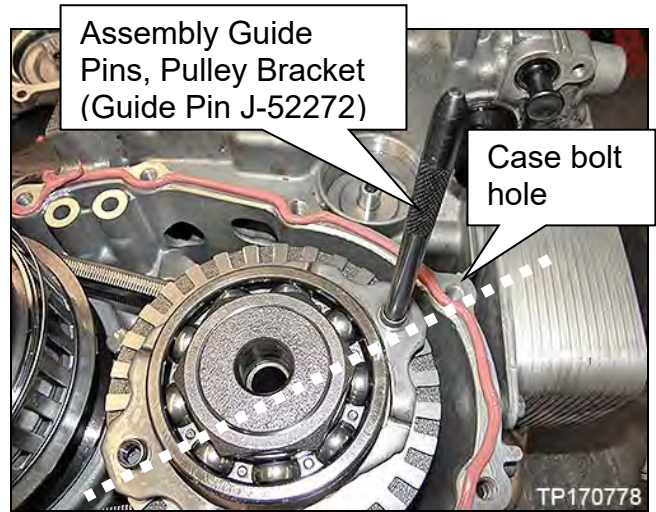

Figure 7U

9. Install side cover.

10. Install eleven (11) new side cover bolts, and then torque all of the side cover bolts to the specified torque in the sequence shown in Figure 8U.

- 32.8 mm (1.3 inches) long bolt.  
11 pieces
  - Bolt torque:  
27.1 N•m (2.8 kg-m, 20 ft-lbs.)

**NOTE:** See **Reference # 6** in the **KIT PARTS REFERENCE TABLE**.

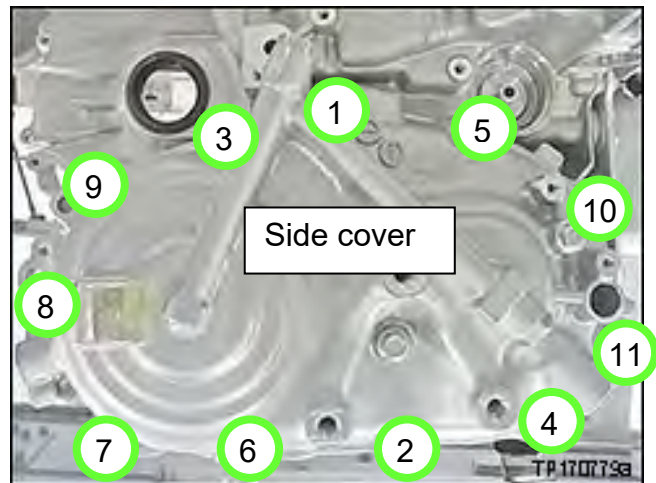

Figure 8U

11. Remove the O-rings that came on the new bearing retainer bolts and replace them with new O-rings from Parts Information.

**NOTE:** See **Reference # 8** in the **KIT PARTS REFERENCE TABLE**.

12. Screw in one (1) original pulley bearing retainer bolt, hand tight.

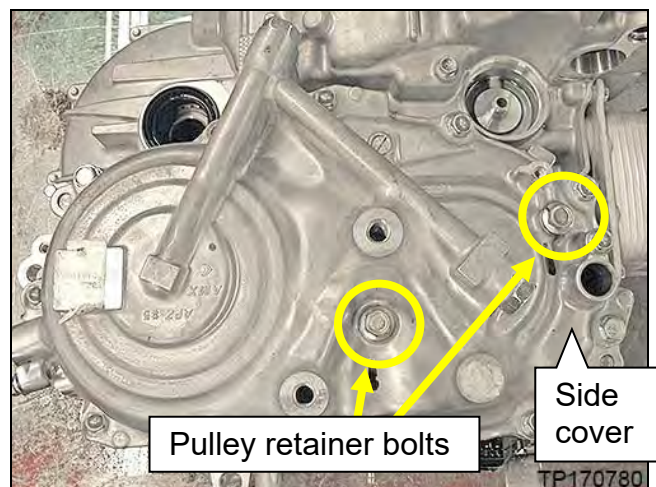

Figure 9U

13. Remove the Guide Pin (J-52272) and then install the other pulley bearing retainer bolt, hand tight.

14. Torque the two pulley bearing retainer bolts to specified torque.

- Bolt torque:  
28.8 N•m, (2.90 kg-m, **21 ft-lbs.**)



Figure 10U

## Install and Adjust the Transmission Range Switch

1. Rotate the manual lever to the “N” position (two clicks counterclockwise from the left hard stop).
2. Remove the lock nut, washer and manual lever from the manual shaft.
  - They will be reused.
3. Adjust the transmission range switch position as follows:

- a. Install the alignment pin (#J-52306-2) into the Transmission Range Switch Alignment Bracket (#J-52306-1) as shown in Figure 2W.
- b. Attach the combined alignment tool onto the manual shaft as shown in Figure 3W with part number facing out.

**NOTE:** The combined alignment tool will only insert into the transmission range switch while in Neutral.

- Transmission range switch may need to be rotated to allow pin to align.
  - Alignment pin will insert into guide hole in the transmission range switch (Figure 1W).
- c. Install the two original bolts for the transmission range switch (Figure 3W).

- Bolt torque:  
5.6 N•m (0.60 kg-m, **50 in-lbs.**)
  - Remove the adjustment tool when complete.

4. Install the manual lever to the manual shaft.
  - a. Set the original manual lever onto the manual shaft.
  - b. Install the washer and the lock nut.
  - c. Torque the lock nut.

- Nut torque:  
16.3 N•m (1.7 kg-m, **12 ft-lbs.**)

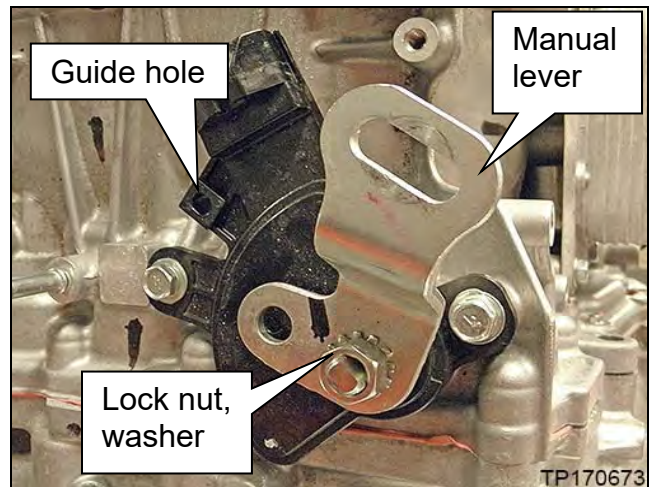

Figure 1W

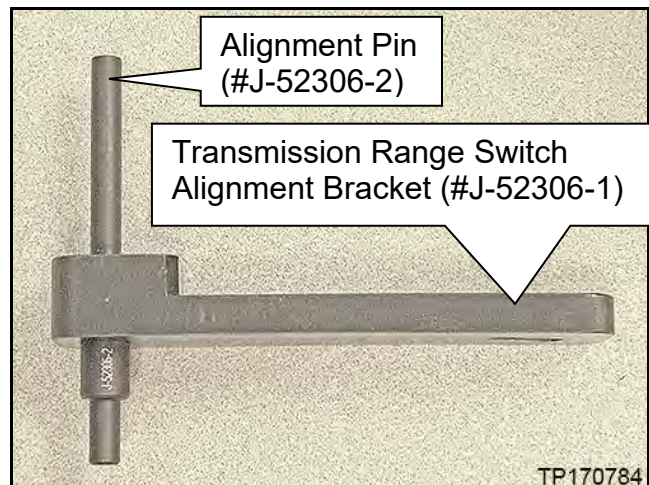

Figure 2W

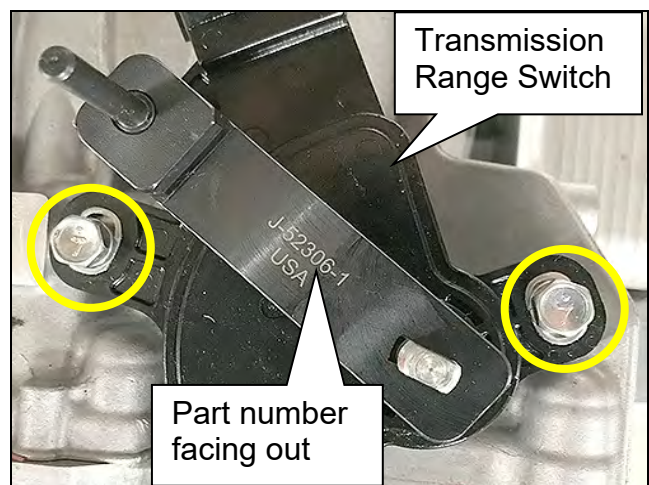

Figure 3W

## Install Exterior CVT Parts

1. Install the differential side oil seal to the CVT case (Figure 1V).

- Use a new oil seal (non-reusable). See **Reference # 18** in the **KIT PARTS REFERENCE TABLE**.

### CAUTION:

- Apply CVT Fluid to the oil seal before installation.
- Drive the differential side oil seal in until the amount of oil seal protrusion from the CVT case edge matches dimension C shown in Figure 1V.

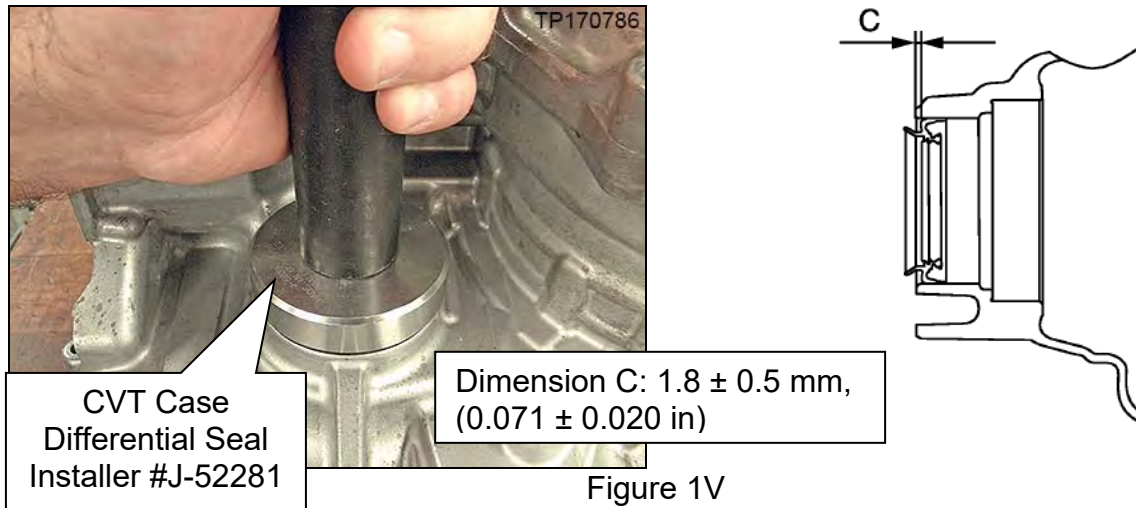

2. Install the differential side oil seal to the converter housing (Figure 2V).

- Use a new oil seal (non-reusable). See **Reference # 18** in the **KIT PARTS REFERENCE TABLE**.

### CAUTION:

- Apply CVT Fluid to the oil seal before installation.
- Drive the differential side oil seal in until the amount of oil seal protrusion from the torque converter housing edge matches the dimension D shown in Figure 2V.

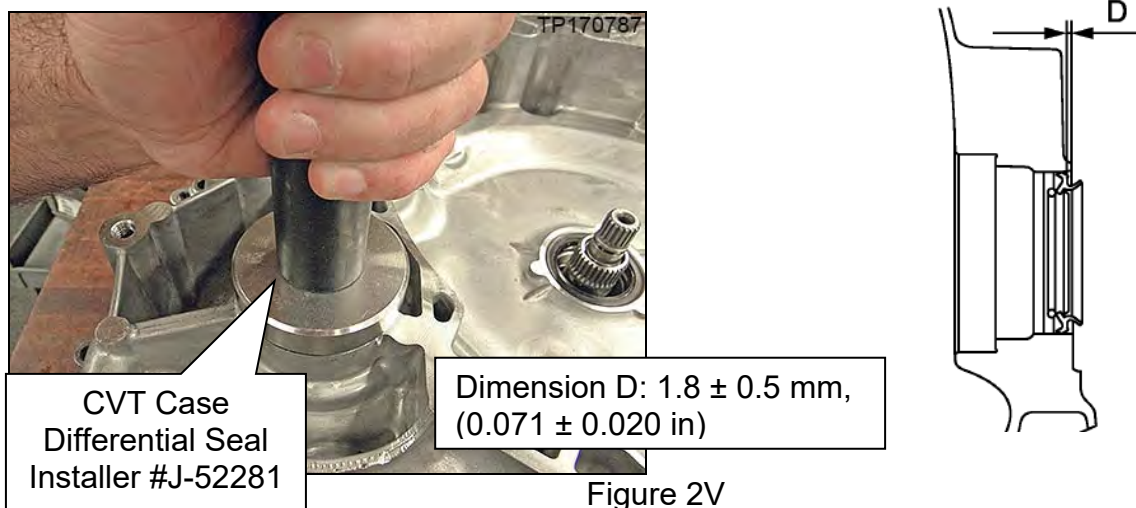

3. Install the torque converter housing oil seal to the torque converter housing (Figure 3V).
  - Use a new oil seal (non-reusable). See **Reference # 17** in the **KIT PARTS REFERENCE TABLE**.

**CAUTION:**

- Apply CVT Fluid to the oil seal before installation.
- Drive the converter housing oil seal evenly so that converter housing oil seal sits below the case by dimension E as shown in Figure 3V.

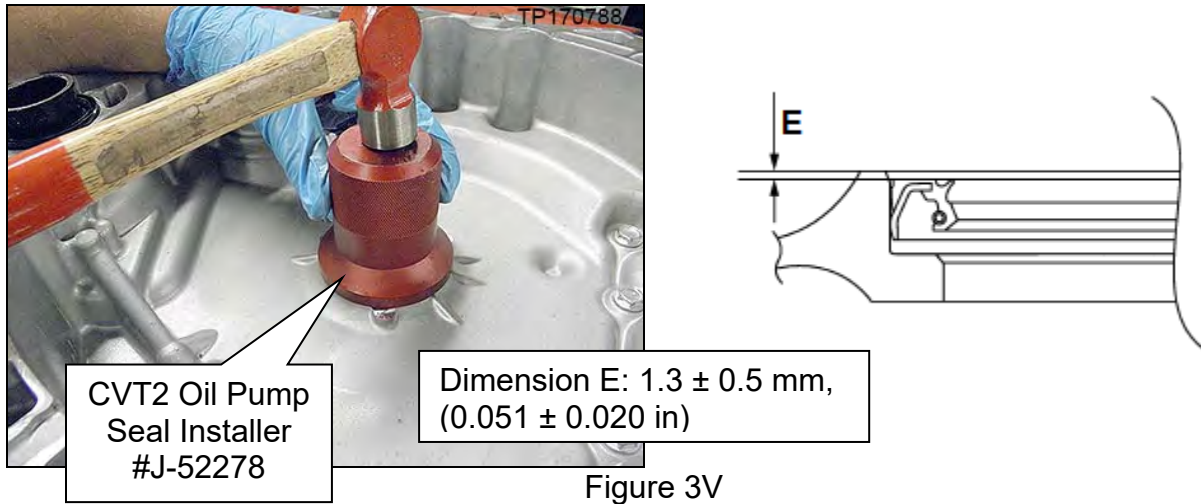

4. Install a new fluid filter to the CVT case.
  - Make sure a grommet is attached to the fluid filter.
  - Apply CVT Fluid to the grommet of the fluid filter.

**NOTE:** See **Reference # 16** in the **KIT PARTS REFERENCE TABLE**.

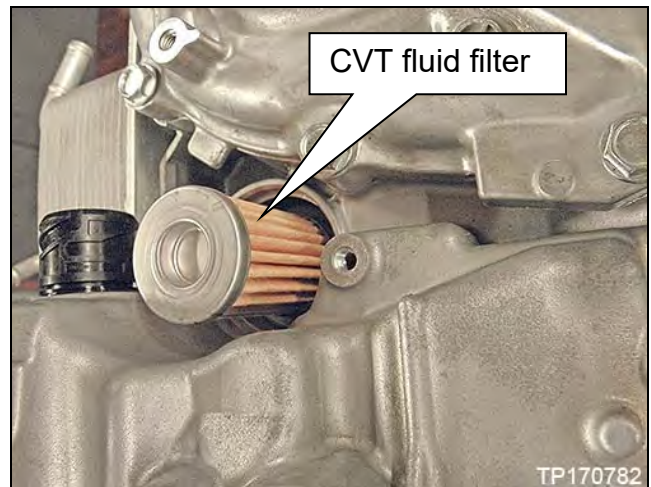

Figure 4V

5. Install the new O-ring to the fluid filter cover.
  - Apply CVT fluid to the O-ring.

**NOTE:** See **Reference # 15** in the **KIT PARTS REFERENCE TABLE**.



Figure 5V

6. Install the fluid filter cover to the CVT case as follows:

- a. Locate the tab of the fluid filter cover near the tab of the side cover as shown.
- b. Push the fluid filter cover onto the CVT case.
- c. Rotate the fluid filter cover clockwise, and then match the bolt hole of the fluid filter cover and the bolt hole of the CVT case.

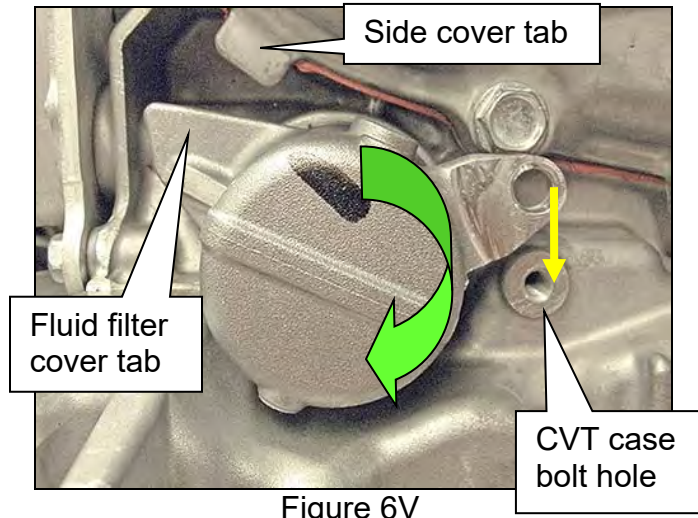

- Confirm that the fluid filter tab is underneath the side cover tab.

d. Install the original bolt.

- 16 mm (**0.6 inches**) long bolt.
- Bolt torque:  
6.8 N•m (0.70 kg-m, **60 in-lbs.**)

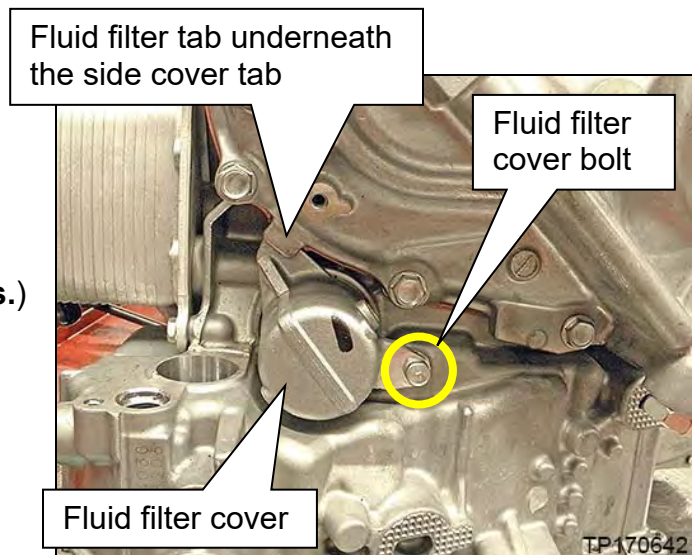

7. Install new O-rings to the original output speed sensor, primary pulley speed sensor and secondary pulley speed sensor and then install them to the CVT.

- Use new O-rings (non-reusable).

**NOTE:** See **Reference # 19** in the **KIT PARTS REFERENCE TABLE**.

- Apply CVT Fluid to the O-rings before installation.
- 16 mm (**0.6 inches**) long bolts.
  - Bolt torque: 5.6 N•m (0.60 kg-m, **50 in-lbs.**)

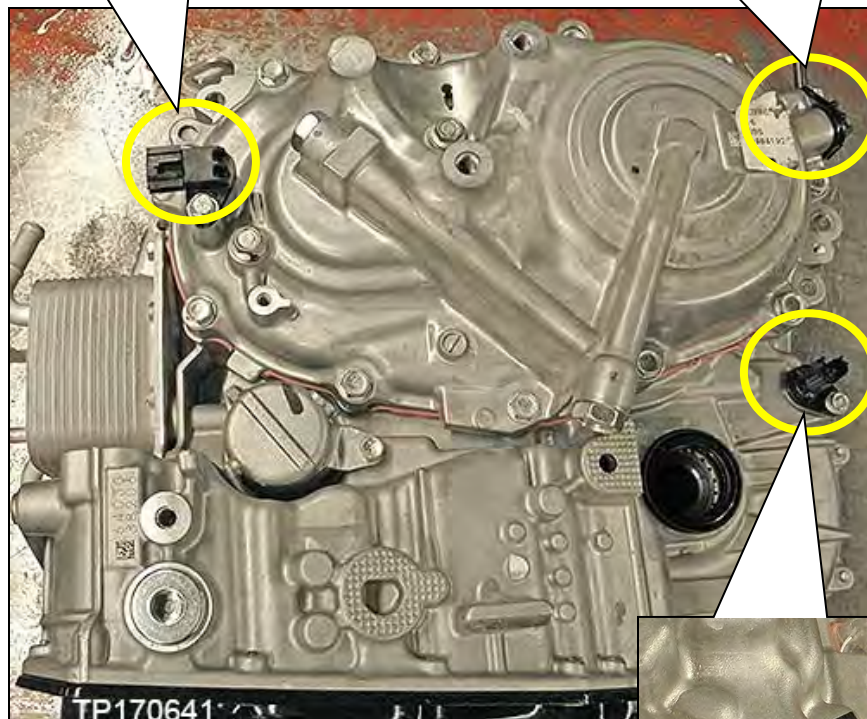
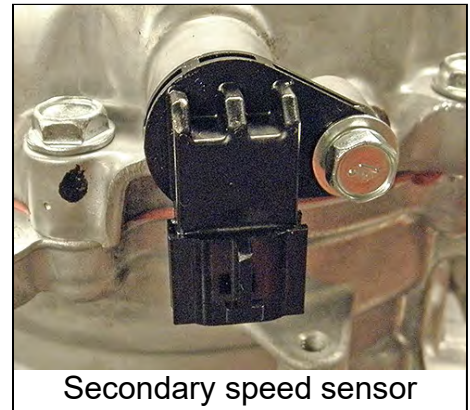
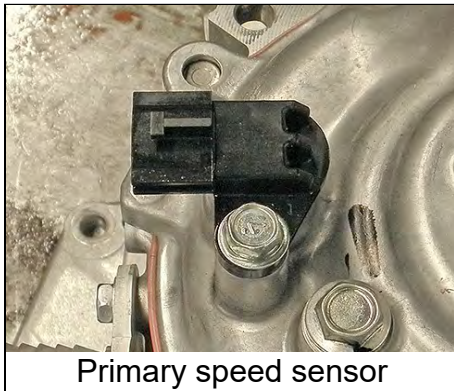
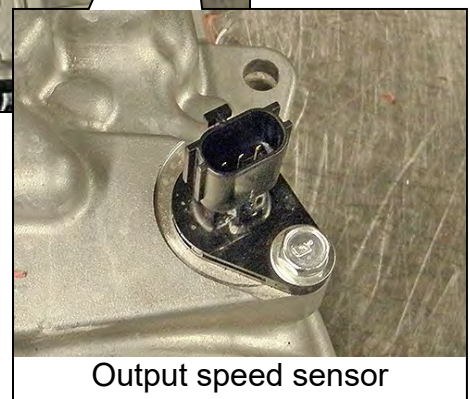

Figure 8V



8. Place the CVT on a work surface with the oil pan side facing down.

9. Install the original torque converter.

**CAUTION:** Locate the two oil pump engagement tabs on the end of the torque converter snout horizontally while inserting to avoid damaging the torque converter oil seal.



Figure 9V

10. Measure dimension A to confirm that the torque converter is installed to the correct position.

- Dimension A: 14.4 mm (0.567 in)

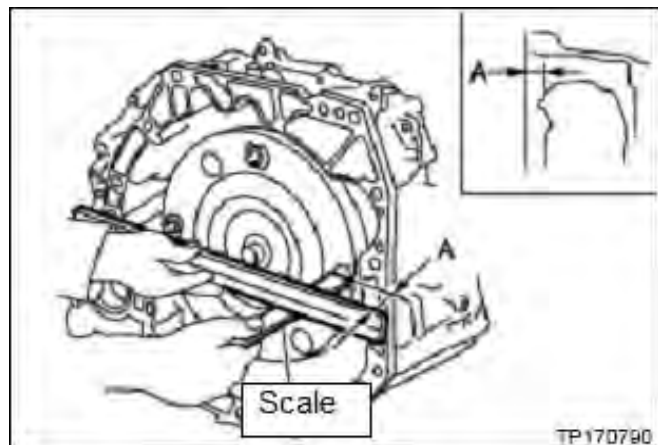

Figure 10V



## Install the CVT Assembly

1. Install the CVT assembly in the vehicle.
  - Refer to the ESM, section **TM-Transaxle & Transmission**, for CVT installation.
2. Connect both battery cables, negative cable last.
3. Fill Transmission with CVT fluid.
4. Reset/reinitialize systems as needed.
  - Refer to the ESM, section **PG – Power Supply & Ground Elements**, for a listing of systems that require reset/initialization after reconnecting the 12V battery.
  - Look in the PG section index for **ADDITIONAL SERVICE WHEN REMOVING BATTERY NEGATIVE TERMINAL**.
  - This list often includes items such as radio, power windows, clock, sunroof, etc.

## ADDITIONAL SERVICE REQUIRED

The following procedures, starting on the next page, must be performed in this order:

### All Applied Models

- a. **TCM REPROGRAMING**.....Page 98
- b. **CONTROL VALVE REPLACEMENT**.....Page 118
- c. **ERASE LEARNING VALUE**.....Page 123
- d. **CONFORM CVTF DETERIORTN**.....Page 125
- e. **Auxiliary gearbox clutch point learning**.....Page 128
- f. **Erase DTCs**.....Page 130

**Proceed to the next page.**

## TCM Reprogramming

**IMPORTANT:** Before starting, make sure:

- ASIST on the CONSULT PC has been synchronized (updated) to the current date.
- All C-III plus software updates (if any) have been installed.
- The CONSULT PC is connected to the internet (Wi-Fi, or cable).

1. Connect the plus Vehicle Interface (plus VI) to the vehicle.

**CAUTION:** Make sure the plus VI is securely connected. If the plus VI connection is loose during reprogramming, the process will be interrupted and the TCM may be damaged.

2. Connect the AC Adapter to the CONSULT PC.

**CAUTION:** Be sure to connect the AC Adapter. If the CONSULT PC battery voltage drops during reprogramming, the process will be interrupted and the TCM may be damaged.

3. Connect a battery maintainer or smart charger, set to reflash mode or a similar setting, to the vehicle battery.

**CAUTION:** Be sure the battery maintainer or smart charger is connected securely to the battery. Make sure the battery voltage stays between 12.0V and 15.5V during reprogramming. If the battery voltage goes out of this range during reprogramming, the TCM may be damaged.

4. Turn OFF all external Bluetooth® devices (e.g., cell phones, printers, etc.) within range of the CONSULT PC and the VI.

**CAUTION:** Make sure to turn OFF all external Bluetooth® devices. If Bluetooth® signal waves are within range of the CONSULT PC and the VI during reprogramming, reprogramming may be interrupted and the TCM may be damaged.

5. Turn the ignition ON with the engine OFF.

- **The engine must not start or run during the reprogramming procedure.**

6. Turn OFF all vehicle electrical loads such as exterior lights, interior lights, HVAC, blower, rear defogger, audio, NAVI, seat heater, steering wheel heater, etc.

**IMPORTANT:** Make sure to turn OFF all vehicle electrical loads. Make sure the battery voltage stays between 12.0V and 15.5V during reprogramming. If the battery voltage goes out of this range during reprogramming, the TCM may be damaged.

7. Turn ON the CONSULT PC.

8. Select CONSULT-III plus (open C-III plus).

9. Wait for the plus VI to be recognized.

- Serial number will display when the plus VI is recognized.

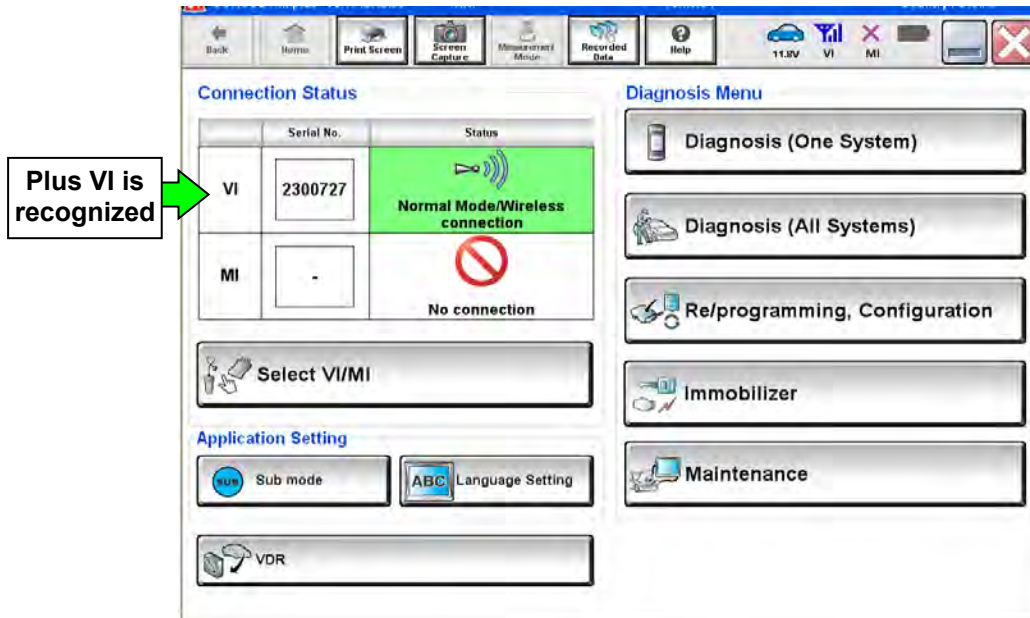

Figure 1

10. Select **Re/programming, Configuration**.

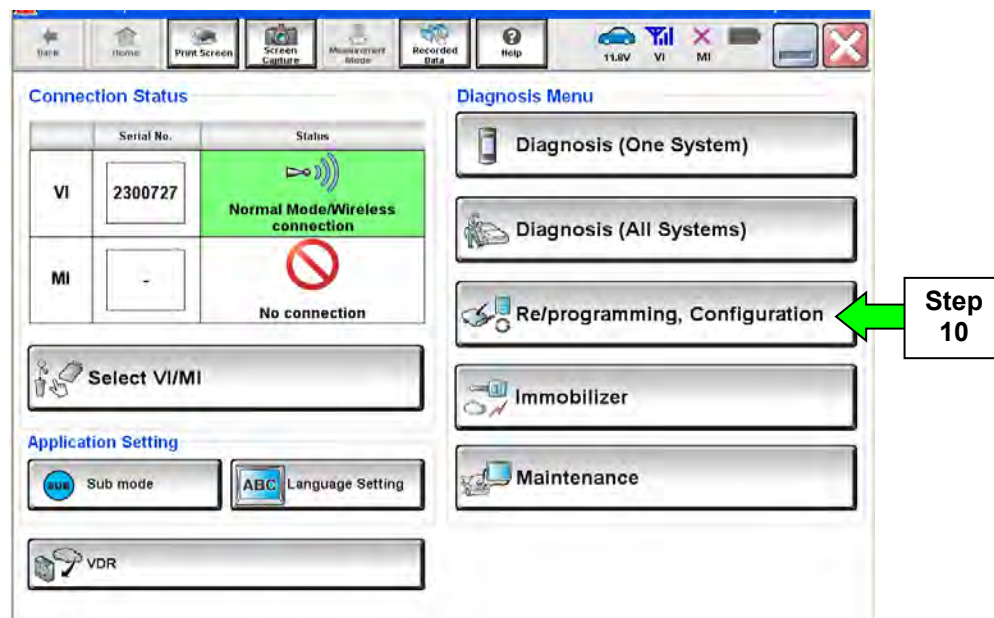

Figure 2

11. Use arrows (if needed) to view and read all precautions.
12. Check the box confirming the precautions have been read.
13. Select **Next**.

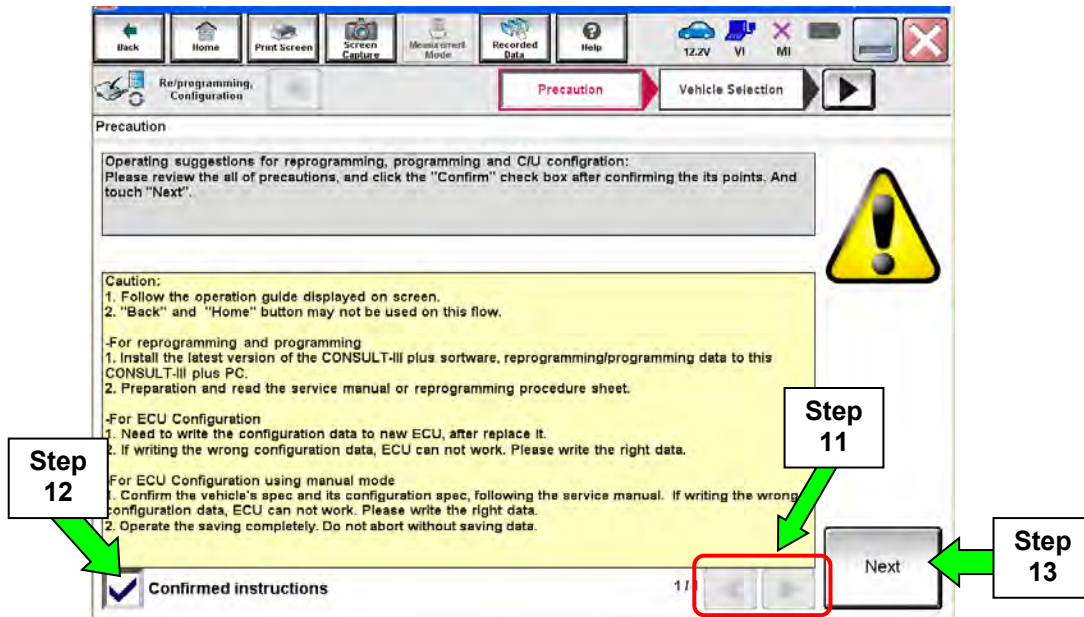

Figure 3

14. If the screen in Figure 4 displays, select **Automatic Selection(VIN)**.

- If the screen in Figure 4 does not display, skip to step 15.

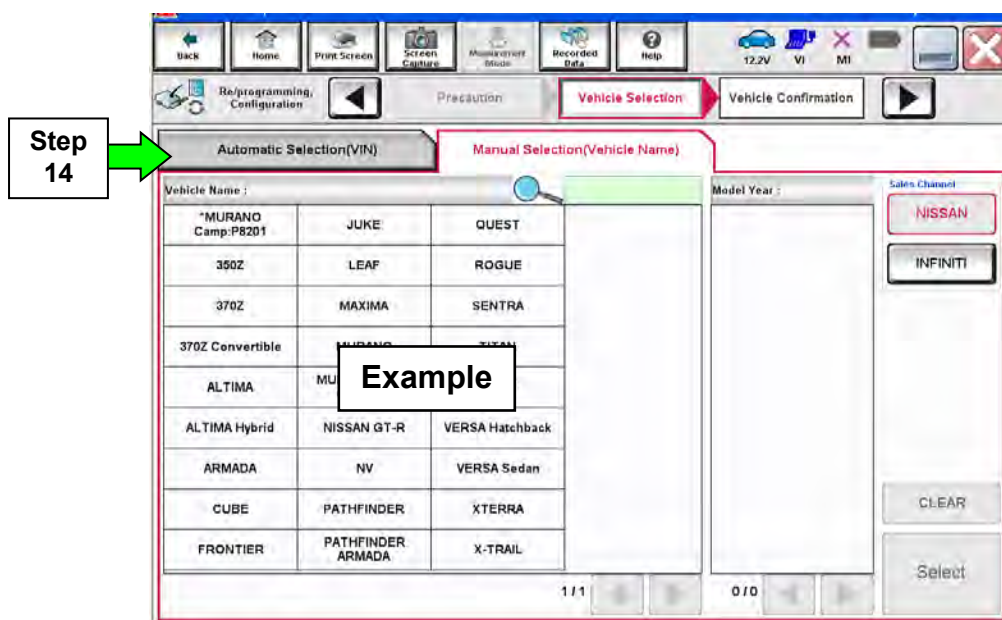

Figure 4

15. Make sure **VIN or Chassis #** matches the vehicle's VIN.

16. If the correct VIN is displayed, select **Confirm**.

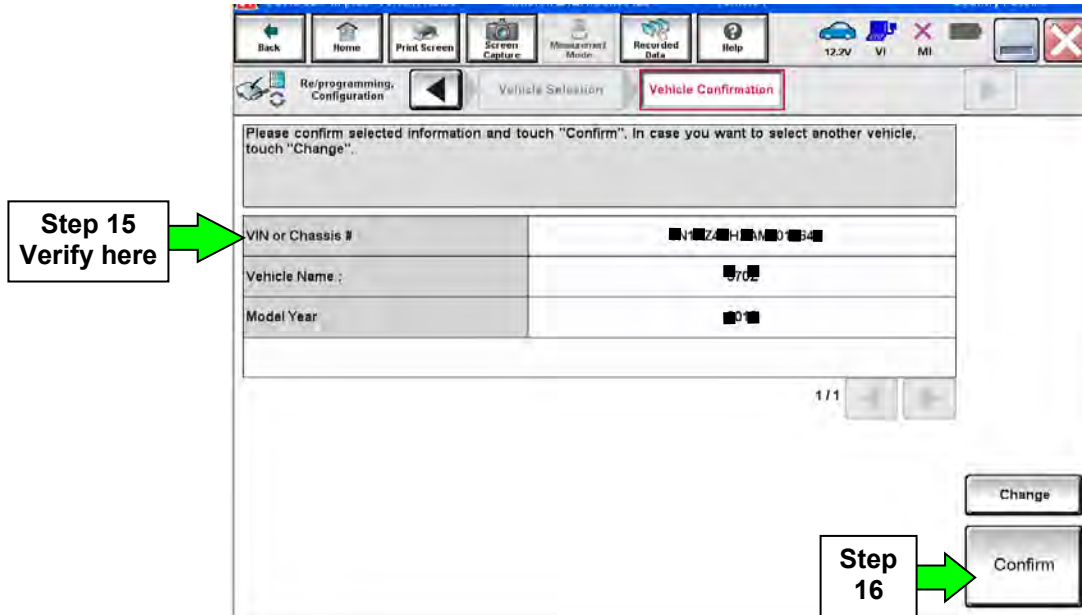

Figure 5

17. Select **Confirm**.

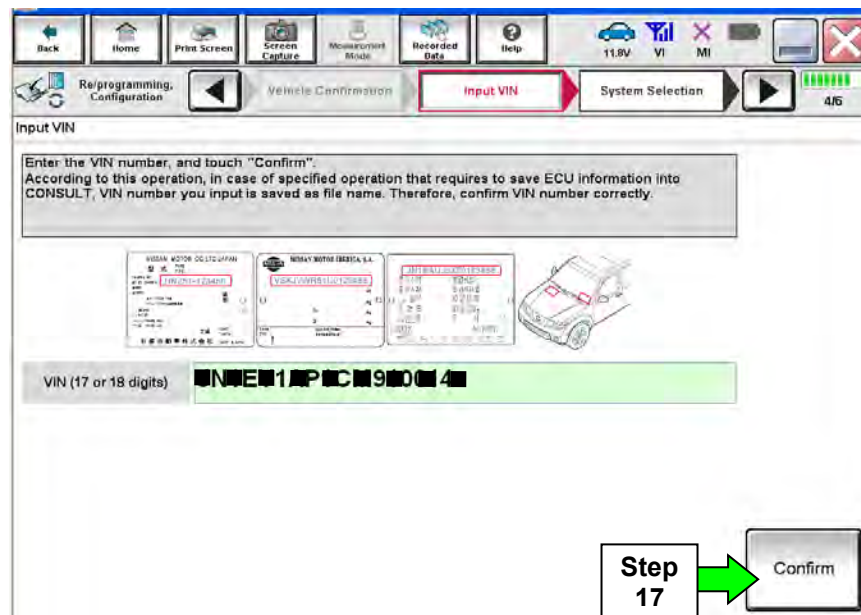

Figure 6

18. Select **TRANSMISSION**.

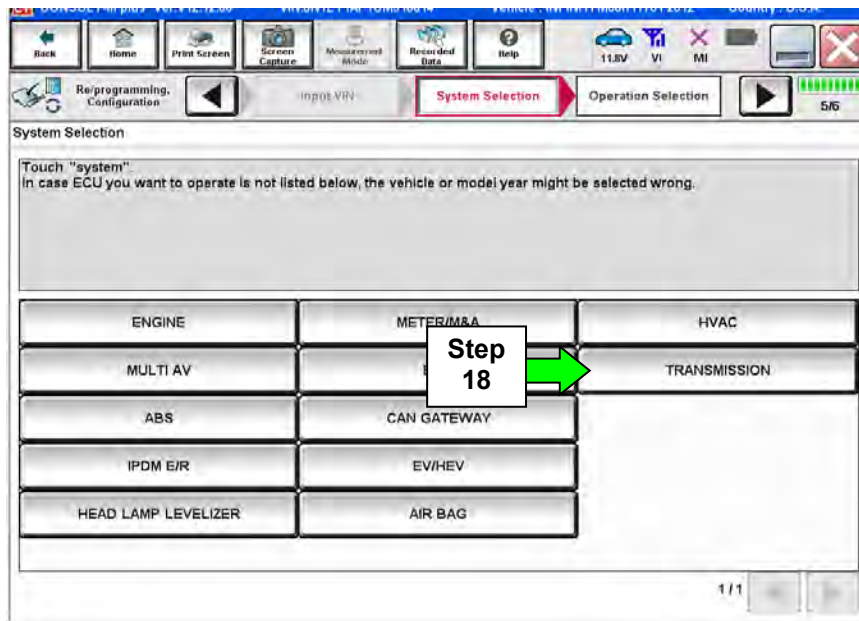

Figure 7

19. Select **Reprogramming**.

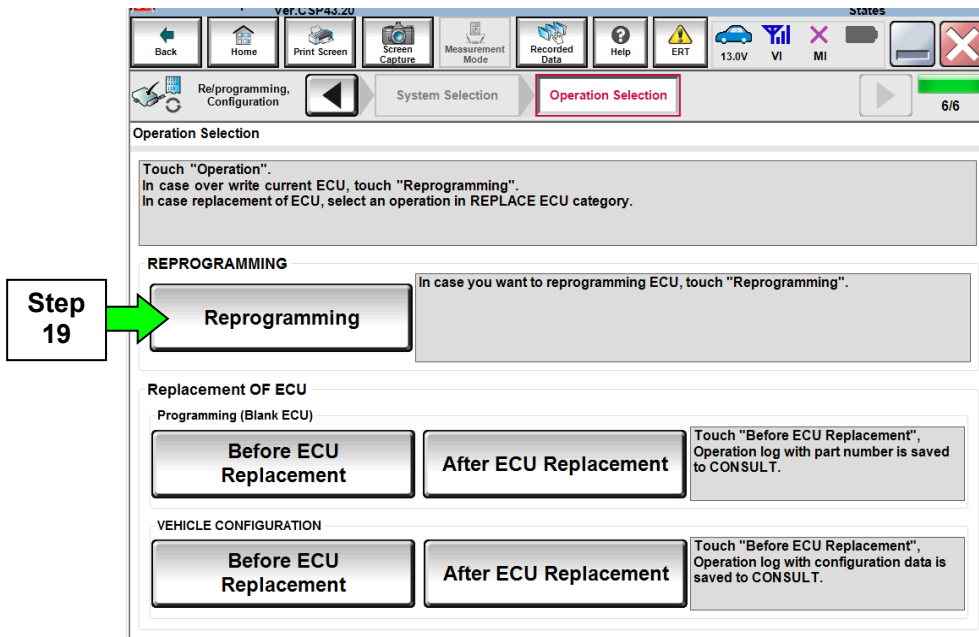

Figure 8

20. Follow the on-screen instructions; maintain the following conditions:

- a. Ignition ON, with the engine OFF.
- b. Press the Brake.
- c. Press accelerator between  $\frac{1}{4}$  and  $\frac{1}{2}$ .
- d. Put shift selector in **R**.

21. Select **Start**.

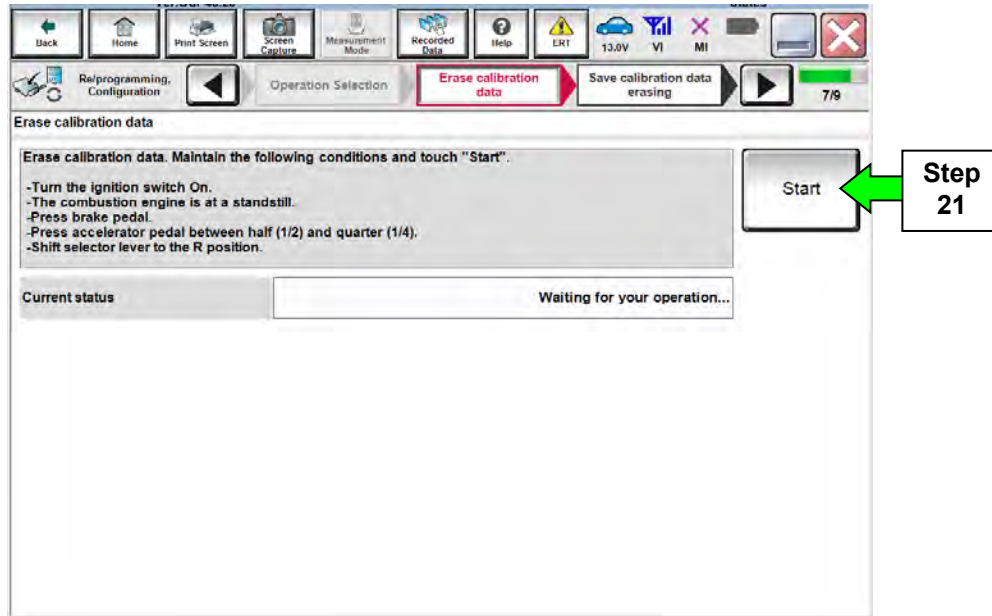

Figure 9

22. When COMPLETED is displayed, select **Next**.

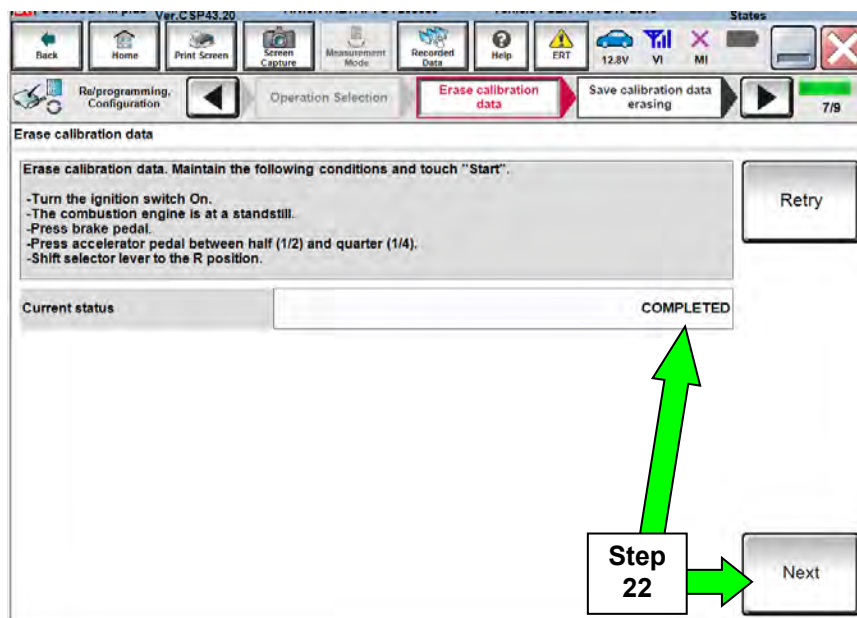

Figure 10

23. Operate the ignition per the on screen instructions.

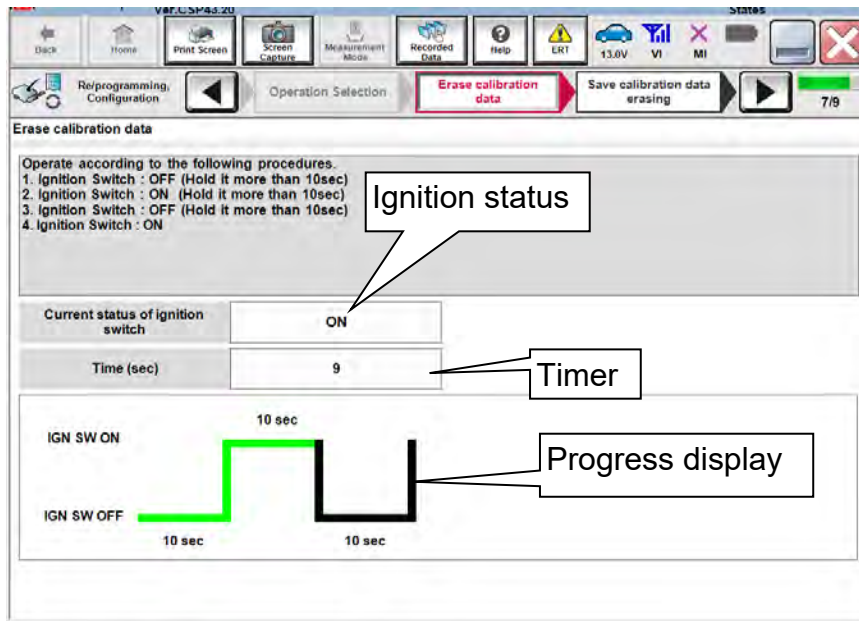

Figure 11

24. When OK is displayed, select **Next**.

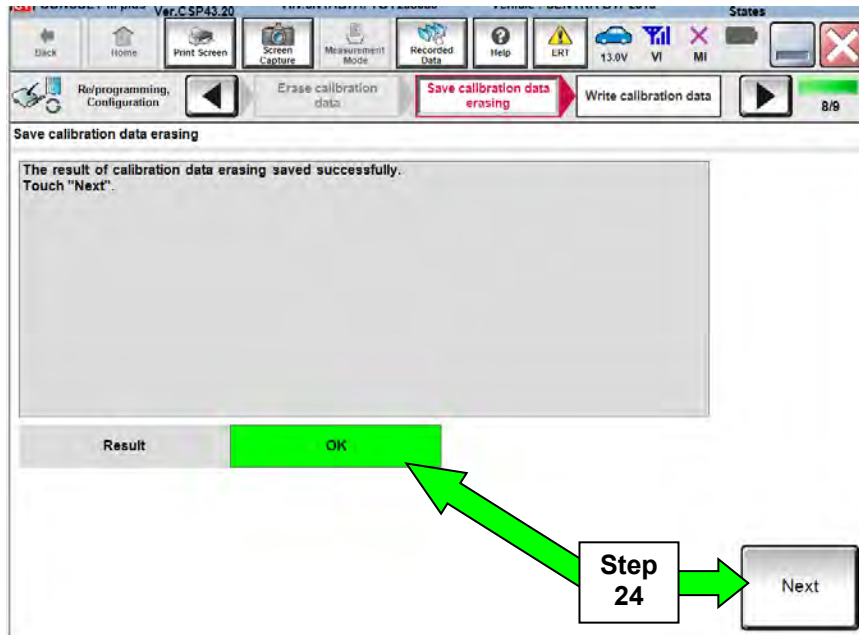

Figure 12



25. Move the shift selector to **P**, then select **Next**.

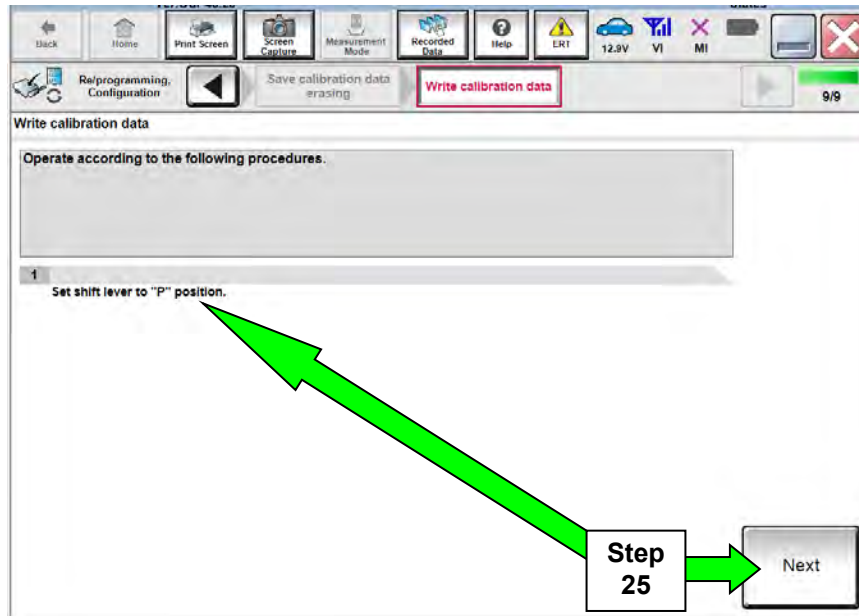

Figure 13

26. Operate the shift selector per the on-screen instructions.

- a. Move the shift selector; **P>R>N>D>P**
- b. Confirm the center display meter indicates the correct selector position.

27. Select **Next**.

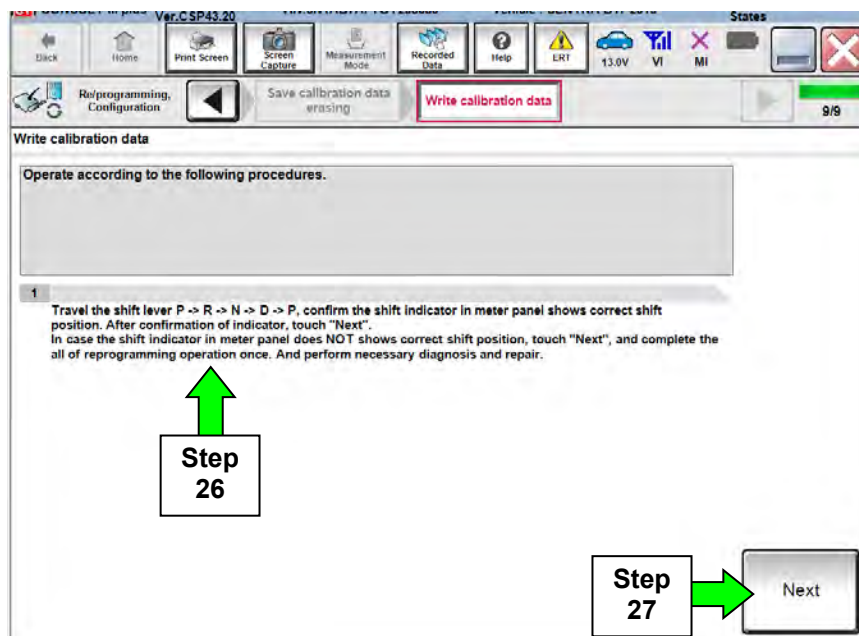

Figure 14

28. Find the TCM **Part Number** (see Figure 15) and write it on the repair order.

**NOTE:** This is the current Part Number (P/N).

29. Compare the P/N you wrote down to the numbers in the **Current TCM Part Number** column in **Table B** below.

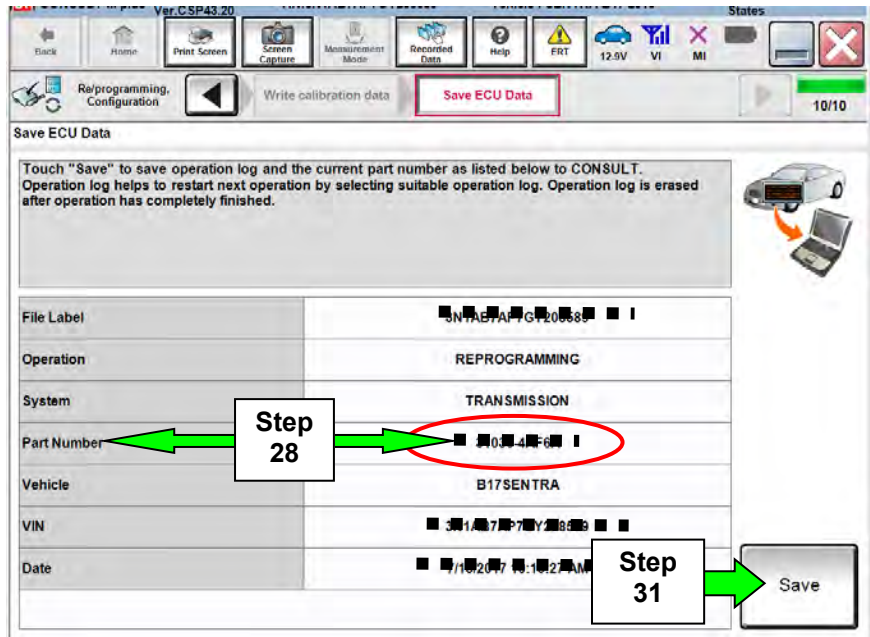

Figure 15

30. Comparison results:

- If there is a match, continue with the reprogramming procedure.
- If there is not a match, reprogramming is not needed. Skip to CONTROL VALVE REPLACEMENT on page 118.

**Table B**

MODEL	YEAR	CURRENT TCM PART NUMBER: 31036 -
Sentra	2013	3SG0A, 3SG0B, 3SG0C, 3SG7E
		3SG8A, 3SG8C, 3SG8D, 3SG9B, 3SG9C
		3SR0A, 3SR0B, 3SR0C, 3SR7E
		3SR8A, 3SR8C, 3SR8D, 3SR9B, 3SR9C
	2014	9AM2A, 9AM2B, 9AM2C, 9AM8C, 9AM8E, 9AM9A, 9AM9B, 9AM9D
	2015	4AT0A, 4AT0B, 4AT0C, 4AT0D, 4AT8B, 4AT8C, 4AT8E 4AT9A, 4AT9D, 4AT9E
	2016	4AF6A, 4AF6B, 4AF8E, 4AF9C, 4AF9D
2017	4FY0A, 4FY0B, 4FY0C, 4FY8E, 4FY9E	
Versa Sedan	2013	9KB1B, 9KB1C, 9KB1D, 9KB9C, 9KB9D, 9KB9E, 9KJ9C, 9KJ9E 3BE8E
	2014	3BE0A, 3BE0B, 3BE8B, 3BE8E, 3BE9A, 3BE9C
	2015	9KE0A, 9KE0B, 9KE0C, 9KE8D, 9KE8E, 9KE9B, 9KE9C, 9KE9E
	2016	9KN0A, 9KN0B, 9KN0C, 9KN6A, 9KN6B, 9KN8B, 9KN8C, 9KN8D 9KN8E
	2017	9KN2A, 9KN2B, 9KN2C, 9KN6E, 9KN7E
Versa Note	2014	3VB2A, 3VB2B, 3VB2C, 3VB6C, 3VB6E, 3VB8C, 3VB9D 3WC5E, 3WC9B
	2015	3VB5C, 3VB5D, 3VB6A, 3WC6E
		3VB9A, 3VB9B, 3VB9C, 3VB9E, 3WC9D
	2016	3VB4A, 3VB4B, 3VB4C, 3VB4D, 3VB5B, 3VB7A 3WC7A, 3WC7E, 3WC8E, 3WC9E
2017	9ME0A, 9ME0B, 9ME0C, 9ME8E, 9ME9E	

31. Select **Save**.

32. Use arrows (if needed) to view and read all precautions.

33. Check the box confirming the precautions have been read.

34. Select **Next**.

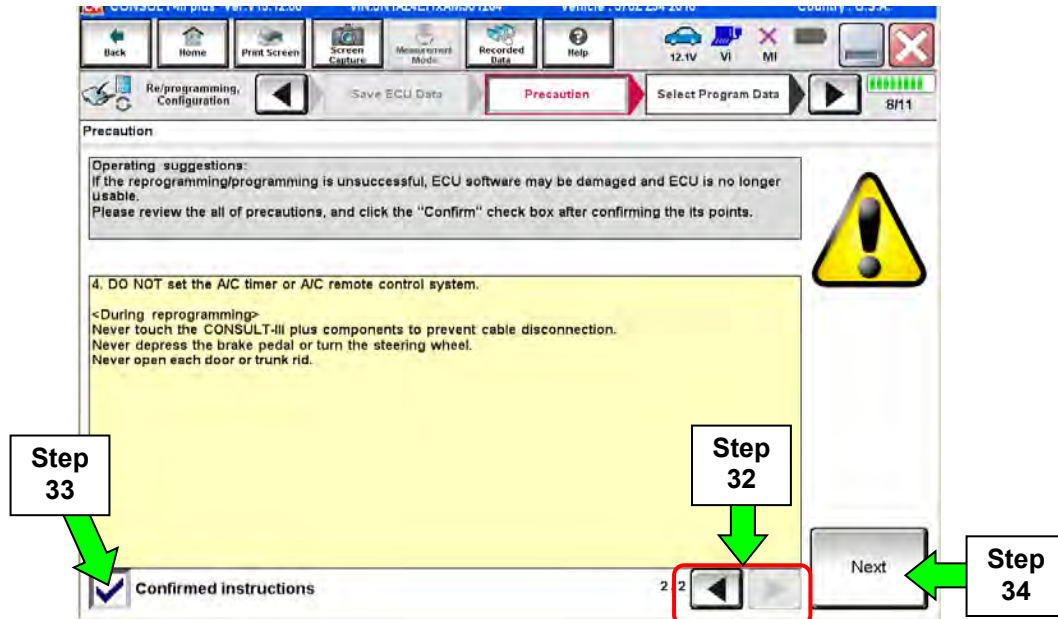

Figure 16

35. Read the **Current Part Number** and **Part Number After Reprogramming**. They should be different.

36. Select **Next**.

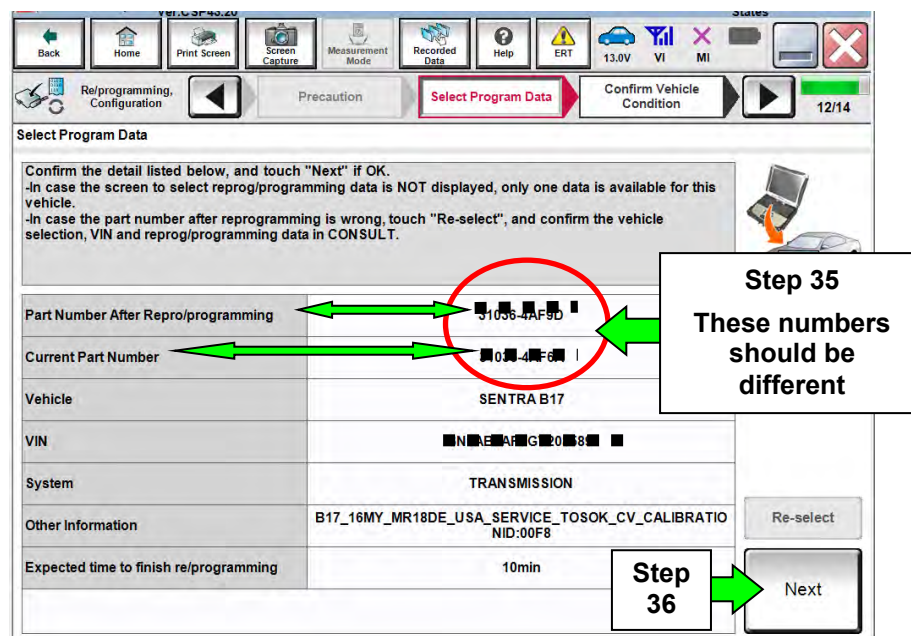

Figure 17

37. Make sure **OK** is highlighted **green** (battery voltage must be between **12.0** and **15.5 Volts**).

38. Select **Next**.

**IMPORTANT:** Battery voltage must stay between **12.0** and **15.5 Volts** during reprogramming or TCM reprogramming may be interrupted and TCM may be damaged.

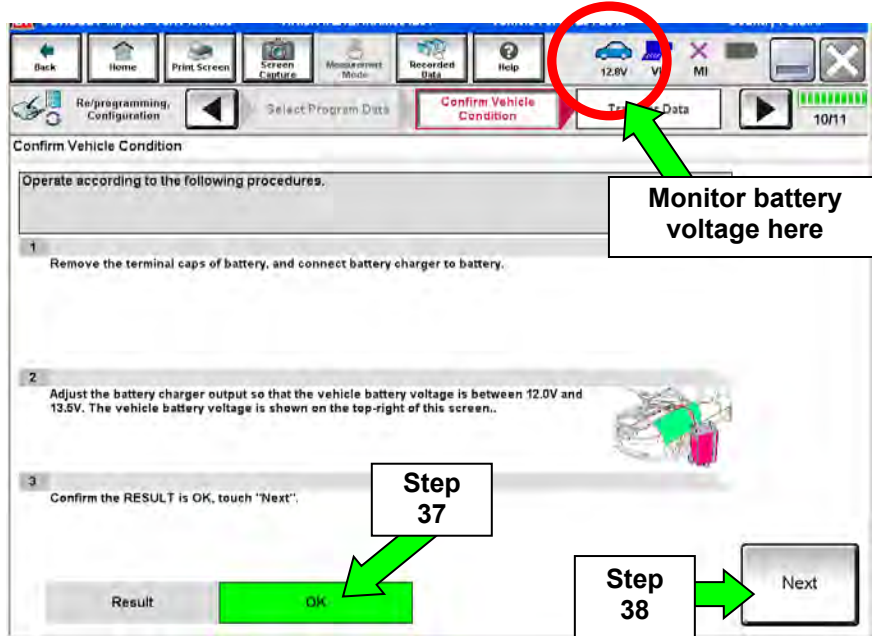

Figure 18

**NOTE:** In the next step, the reprogramming process will begin when **Start** is selected.

39. Select **Start**.

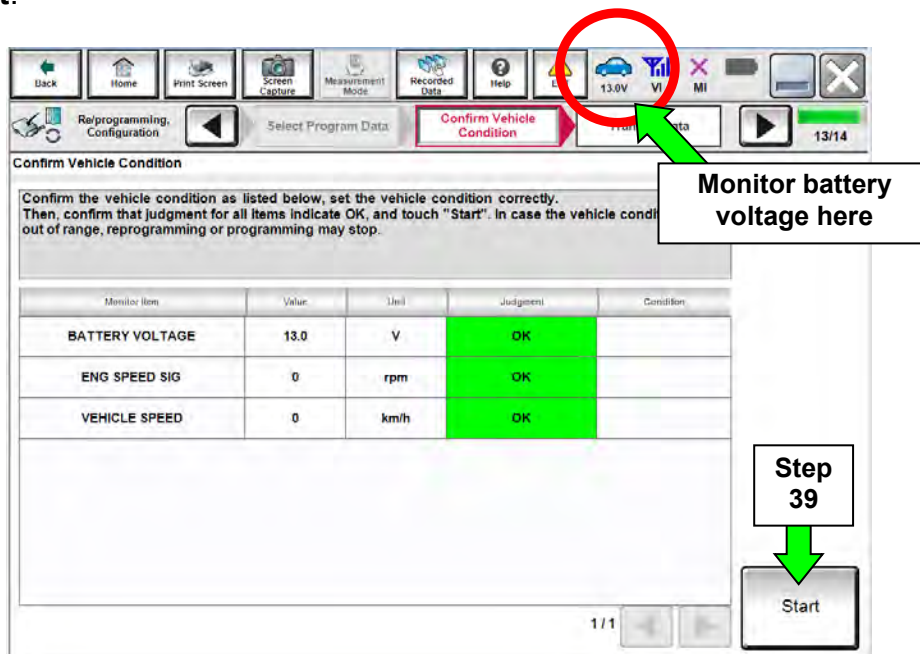

Figure 19

- If a screen display asking for “Please select your user group”, select USA/CANADA Dealers.
- Before reprogramming will start, you will be required to enter your User Name and Password.
  - The CONSULT PC must be connected to the Internet (Wi-Fi or cable).
  - If you do not know your User Name and Password, contact your Service Manager.

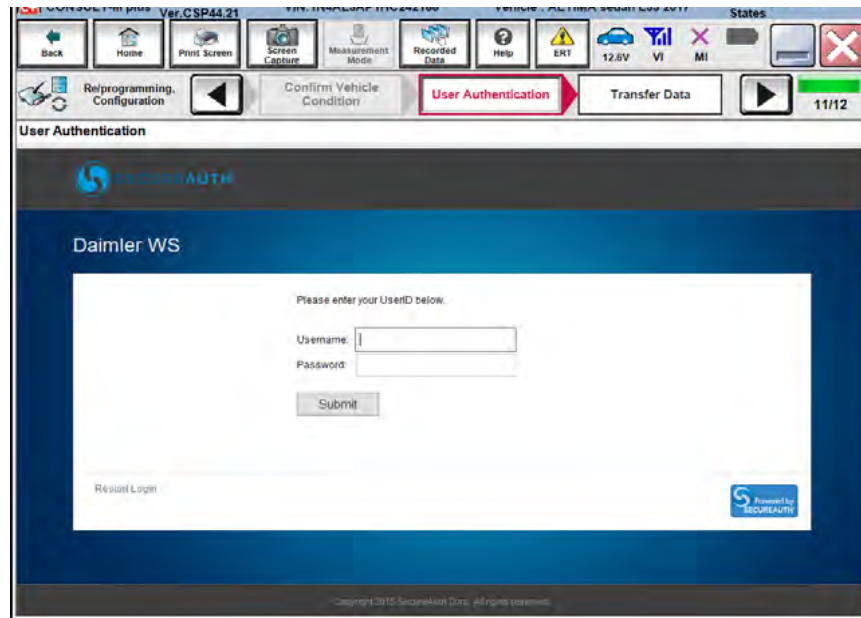

Figure 20

40. Wait for both progress bars to complete.

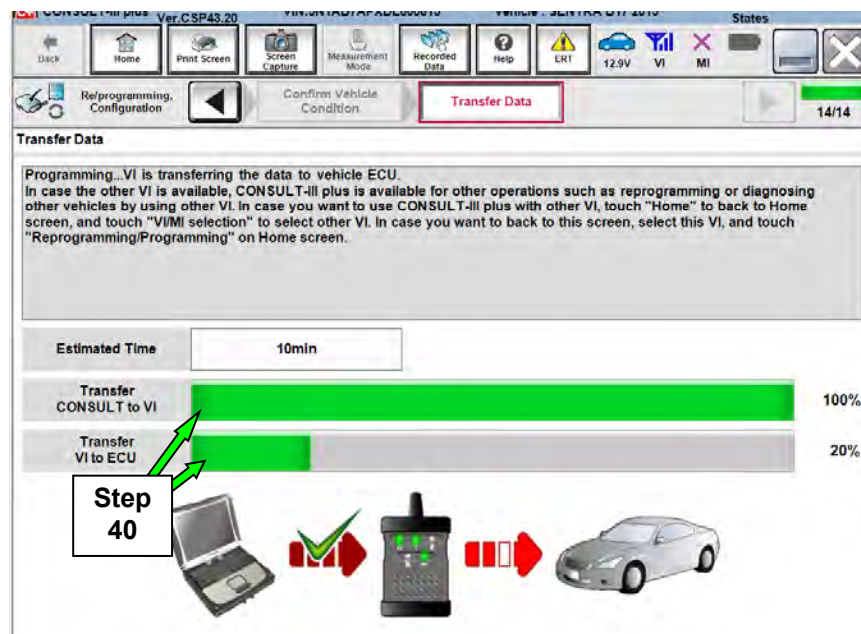

Figure 21

41. When the screen in Figure 22 displays, the reprogramming is complete.

**NOTE:** If the screen in Figure 22 does not display (which indicates reprogramming did not complete), refer to the information on the next page.

42. Disconnect the battery maintainer/smart charger from the vehicle.

43. Select **Next**.

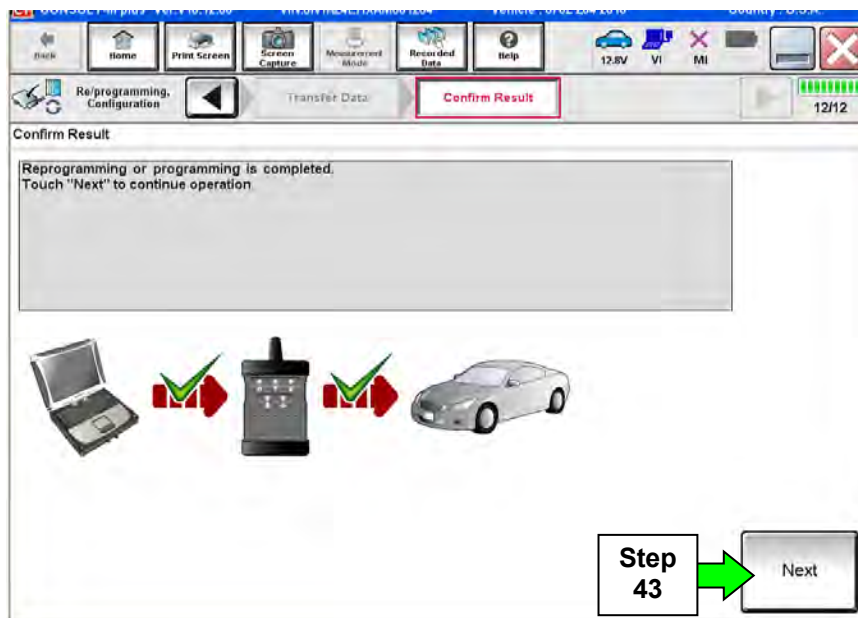

Figure 22

**NOTE:** Additional steps/operations are required before C-III plus will provide the final reprogramming confirmation report. Continue with the reprogramming procedure on page 112.

If reprogramming does not complete and the “!?” symbol displays as shown in Figure 23:

- Check battery voltage (12.0 – 15.5V).
- Ignition ON, engine OFF.
- External Bluetooth® devices are OFF.
- All electrical loads are OFF.
- **Select Retry and follow the on screen instructions.**

**NOTE:** Retry may not go through on first attempt and can be selected more than once.

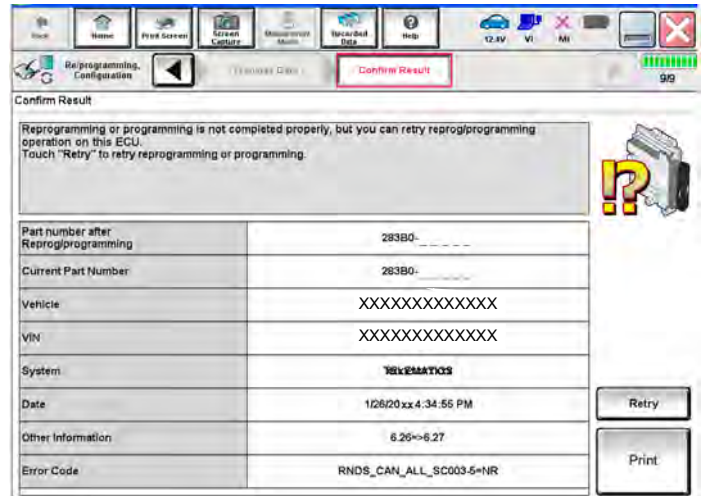

Figure 23

If reprogramming does not complete and the “X” symbol displays as shown in Figure 24:

- **Do not disconnect the plus VI or shut down C-III plus if reprogramming does not complete.**
- Check battery voltage (12.0 – 15.5V).
- CONSULT A/C adapter is plugged in.
- Ignition ON, engine OFF.
- Transmission in Park.
- All C-III plus / plus VI cables are securely connected.
- All C-III plus updates are installed.
- **Select Home, and then restart the reprogram procedure from the beginning.**

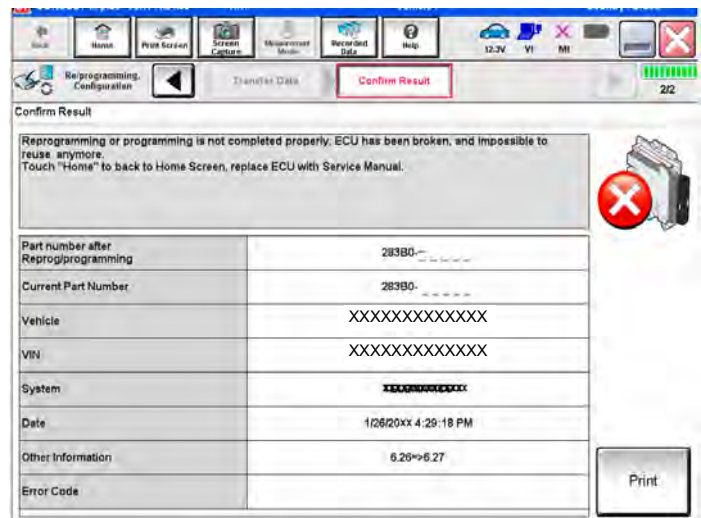

Figure 24

44. Confirm the Transmission Fluid temperature judgment is **OK**, then select **Next**.
- If the judgment is NG, drive the vehicle to warm the transmission until the judgment changes to OK.

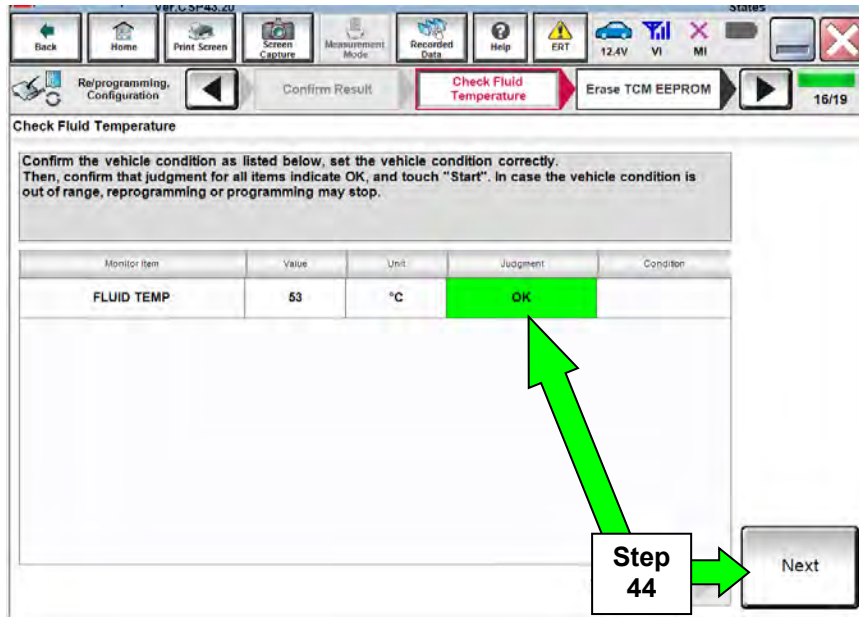

Figure 25



45. Follow the on-screen instructions; maintain the following conditions:

- a. Parking brake set.
- b. Ignition ON, with the engine OFF.
- c. Press the Brake.
- d. Press accelerator between  $\frac{1}{4}$  and  $\frac{1}{2}$ .
- e. Put shift selector in **R**.

46. Select **Erase DTC**.

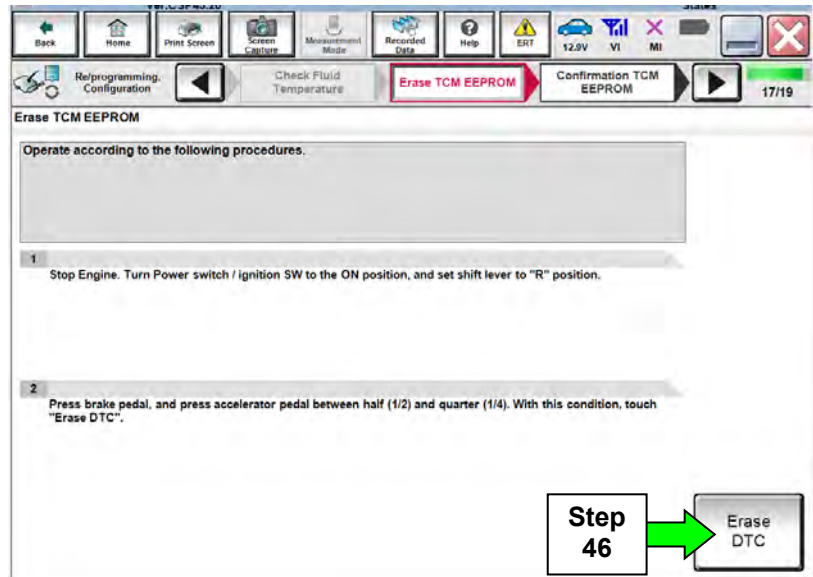

Figure 26

47. Follow the on-screen instructions; maintain the following conditions:

- a. Parking brake set.
- b. Ignition ON, with the engine OFF.
- c. Fully depress the accelerator.
- d. Put shift selector in **R**.

48. Select **Start**.

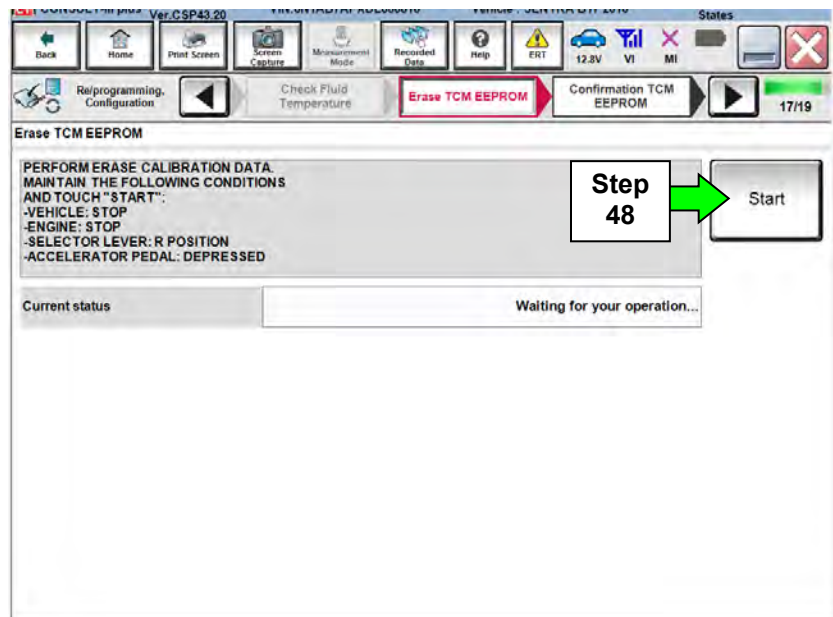

Figure 27

49. When COMPLETED is displayed, select **Next**.

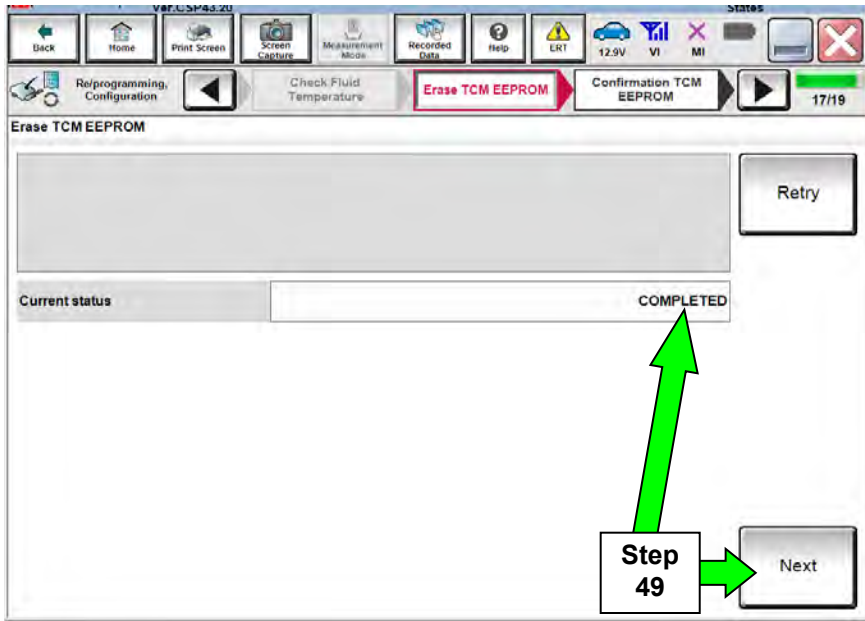

Figure 28

50. Operate the ignition per the on-screen instructions.

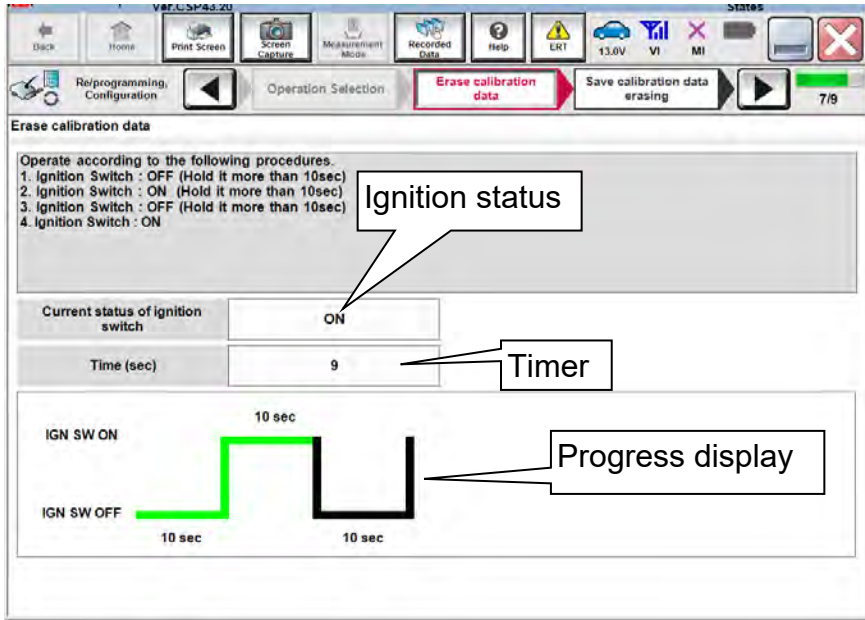

Figure 29

51. When OK is displayed, select **Next**.

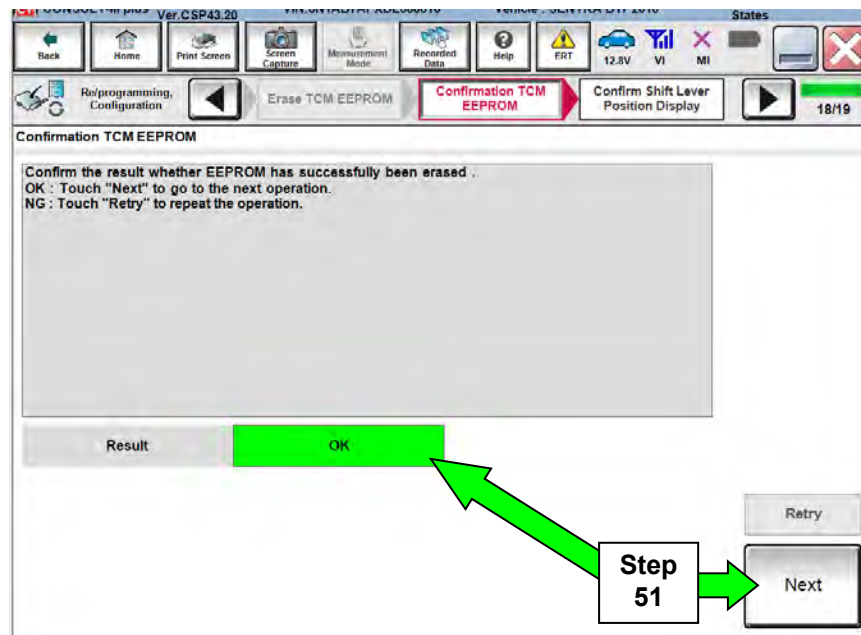

Figure 30

52. Operate the shift selector per the on-screen instructions.

- a. Move the shift selector to **P**; then move **P>R>N>D>P**.
- b. Confirm the center display meter indicates the correct selector position.

53. Select **Next**.

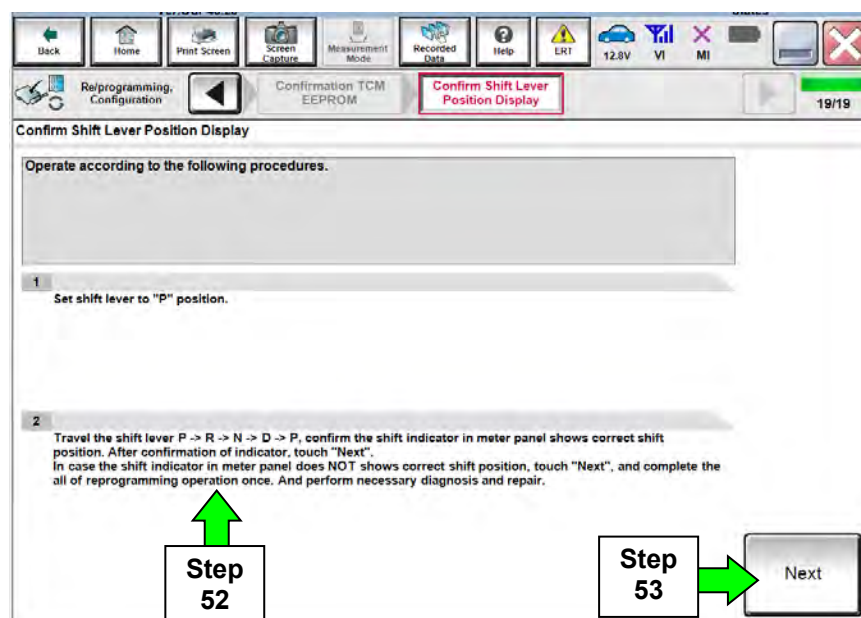

Figure 31

- 54. Erase all DTCs as follows:
  - a. Turn the ignition OFF.
  - b. Turn the Ignition ON.
  - c. Wait for DTC erase to complete.

55. Select **Next**.

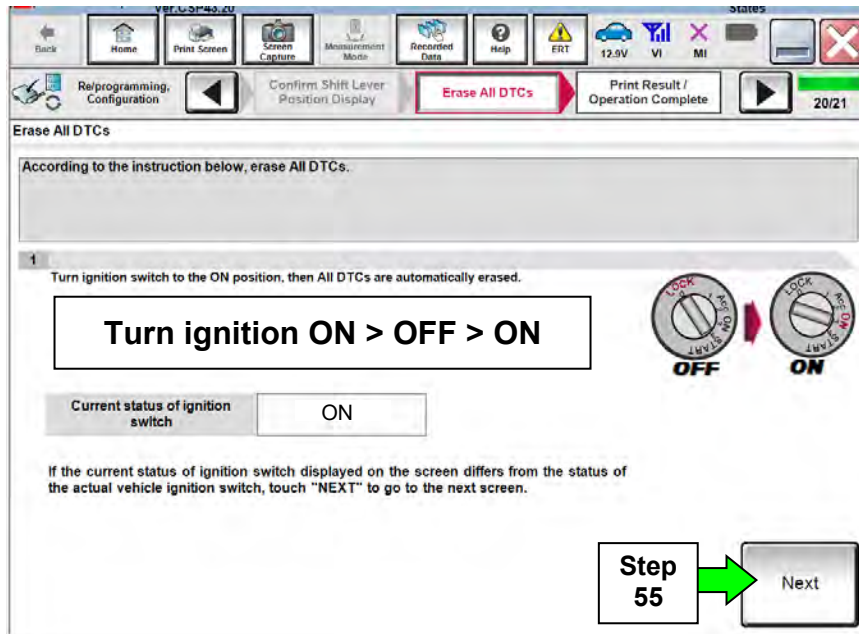

Figure 32

56. Verify the before and after part numbers are different.

57. Print a copy of this screen (Figure 33) and attach it to the repair order.

58. Select **Confirm**.

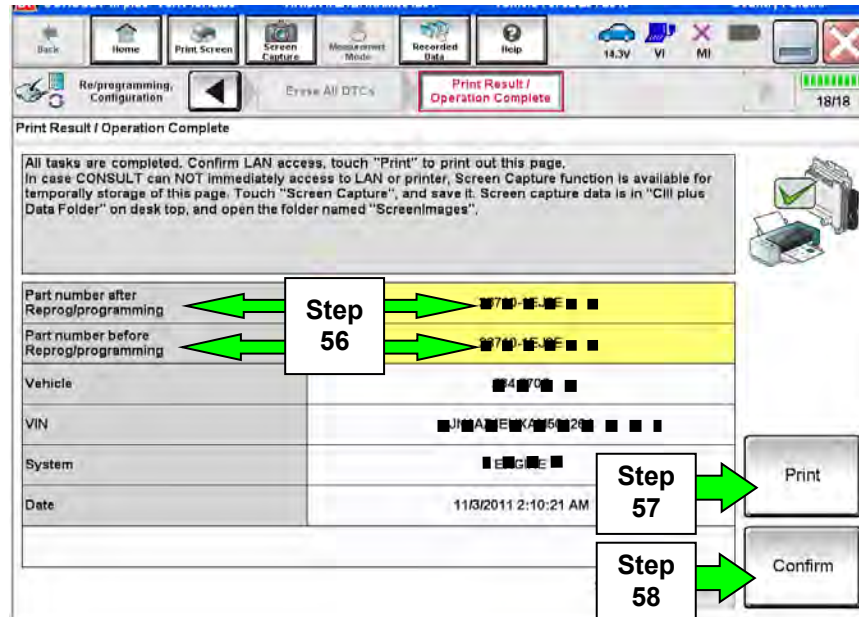

Figure 33

**NOTE:** If you cannot print the above screen:

- Select Screen Capture.
- Name the file.
- Save the file in My Documents.

- A copy of the screen is now saved in the CONSULT PC. It can be retrieved and printed at a later time.

# CONTROL VALVE REPLACEMENT

59. Navigate C-III plus to the screen shown in Figure 34.

- **Diagnosis (All Systems) > TRANSMISSION > Work support**

60. Select **CONTROL VALVE REPLACEMENT**.

61. Select **Start**.

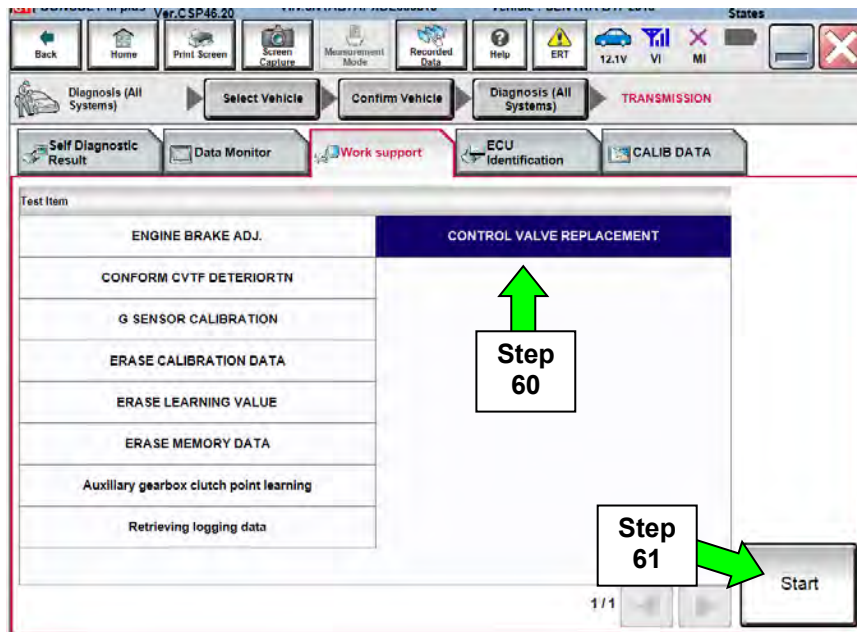

Figure 34

62. Follow the on-screen instructions; maintain the following conditions:

- a. Ignition ON, with the engine OFF.
- b. Press the Brake.
- c. Press accelerator between  $\frac{1}{4}$  and  $\frac{1}{2}$ .
- d. Put shift selector in **R**.

63. Select **Start**.

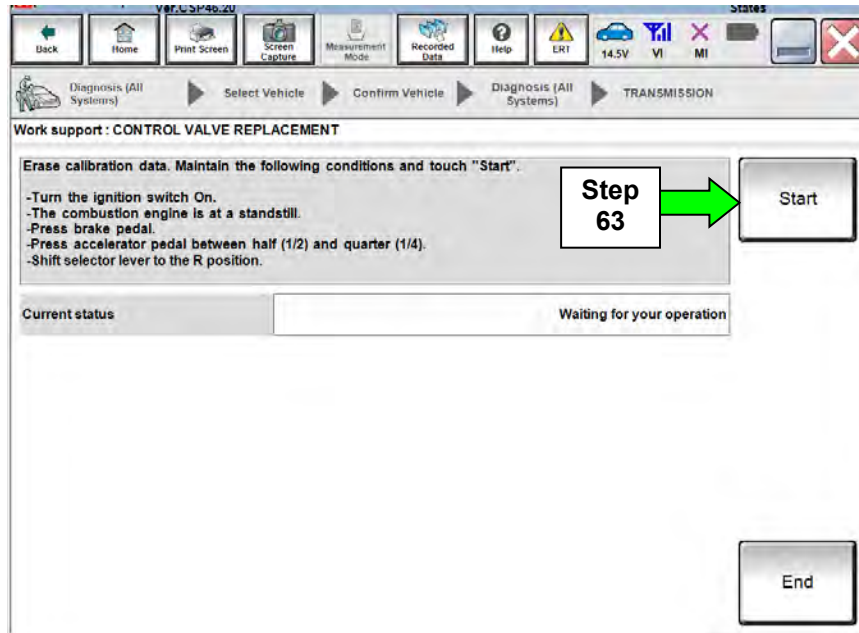

Figure 35

64. Release the accelerator and brake (shift selector remains in **R**).

65. Turn the ignition **OFF**, then wait 10 seconds.

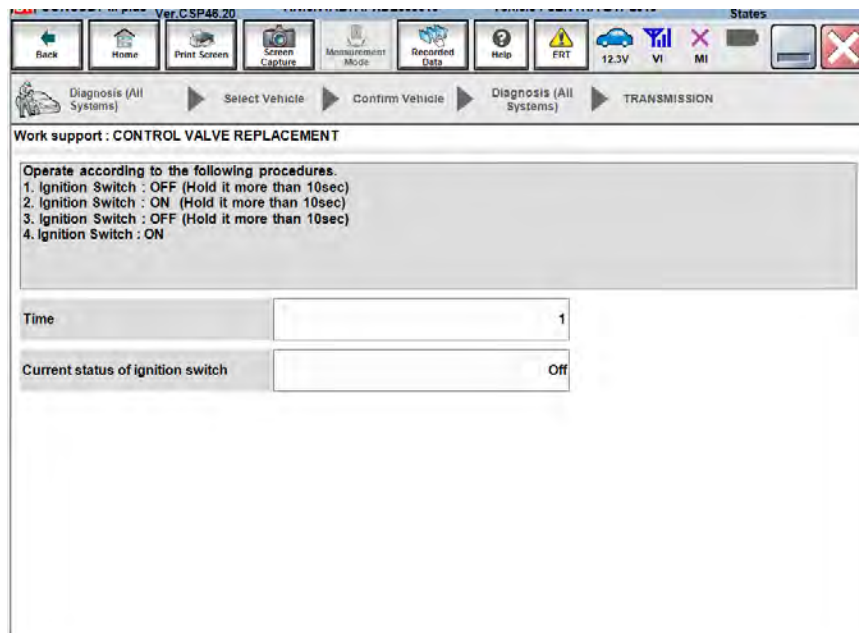

Figure 36

66. Turn the ignition **ON**, then wait 10 seconds.

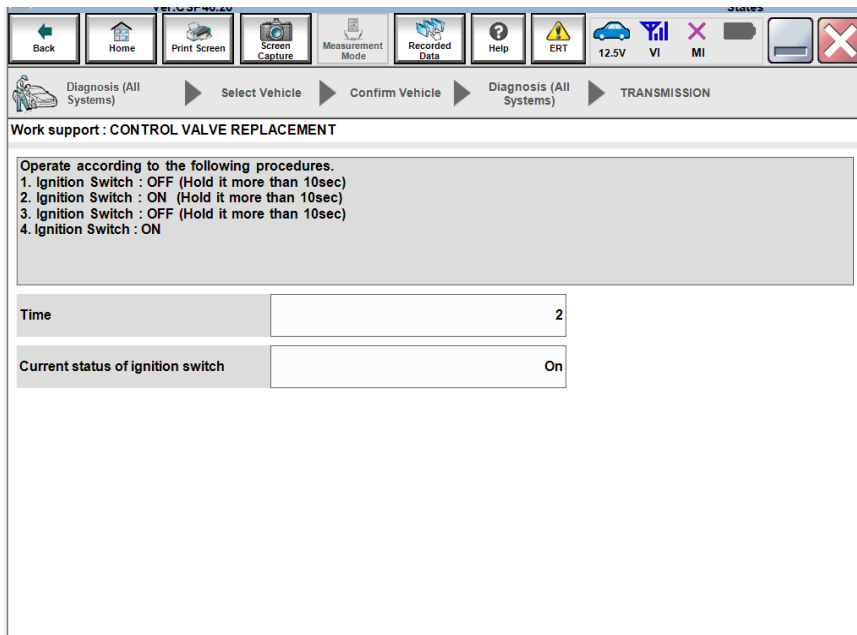

Figure 37

67. Turn the ignition **OFF**, then wait 10 seconds.

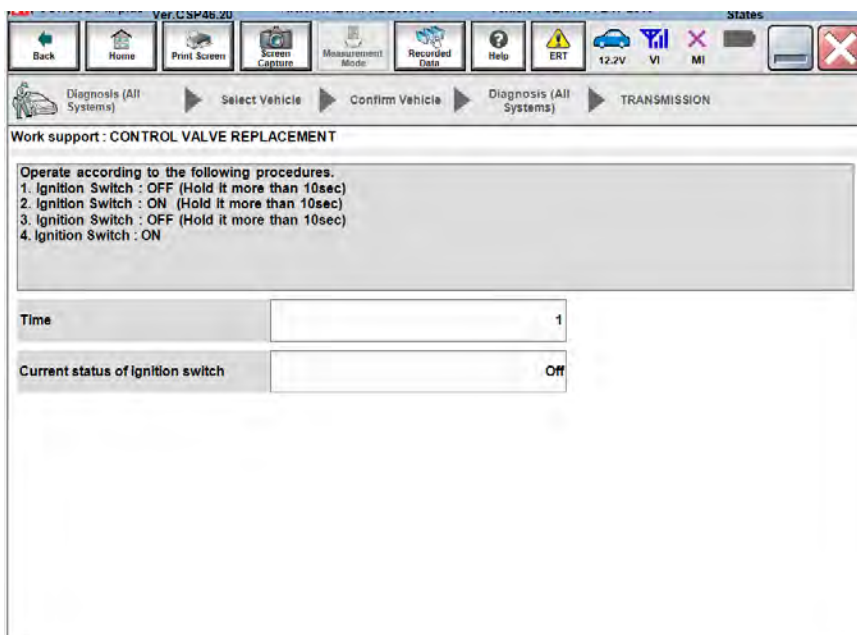

Figure 38



68. Turn the ignition **ON**.

69. Move shift selector to **P**.

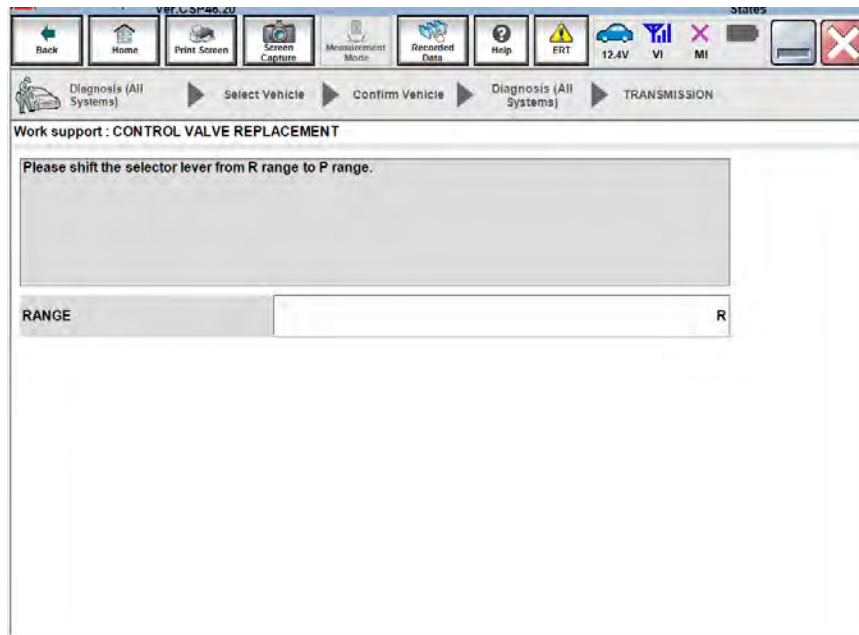

Figure 39

70. When COMPLETED is displayed, select **End**.

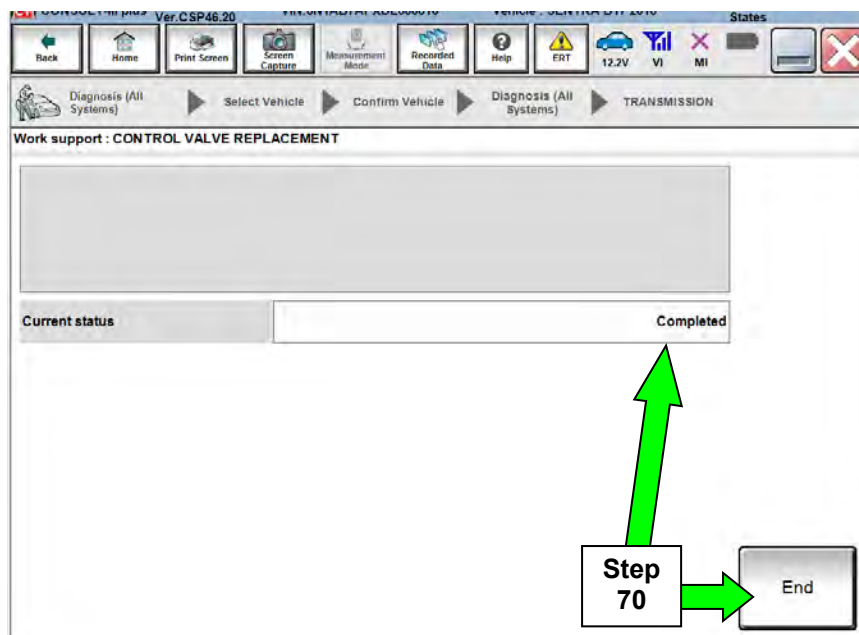

Figure 40

71. Does the pop-up notification in Figure 41 display?

**YES:** TCM Programming is not correct for the installed Control Valve. Select **OK**, then perform **TCM Reprogramming**, starting on page 98.

**NO:** Proceed to step 72.

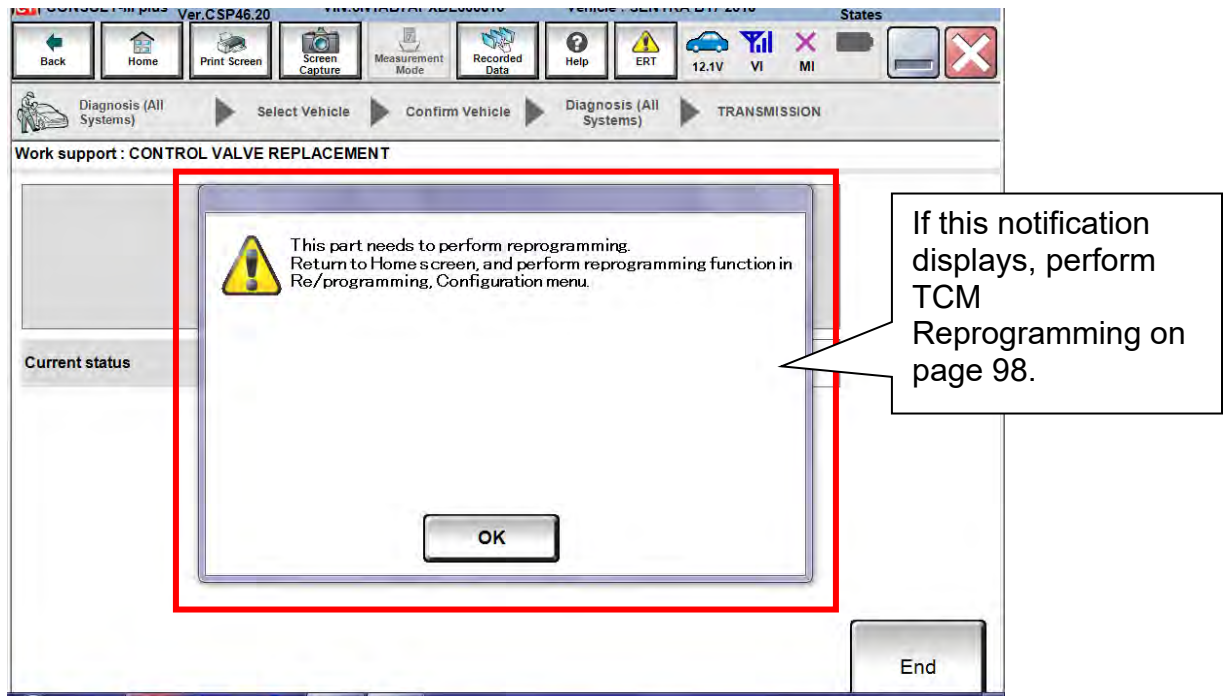

Figure 41

## ERASE LEARNING VALUE

72. Navigate C-III plus to the screen shown in Figure 42.

- **Diagnosis (All Systems) > TRANSMISSION > Work support**

73. Select **ERASE LEARNING VALUE**.

74. Select **Start**.

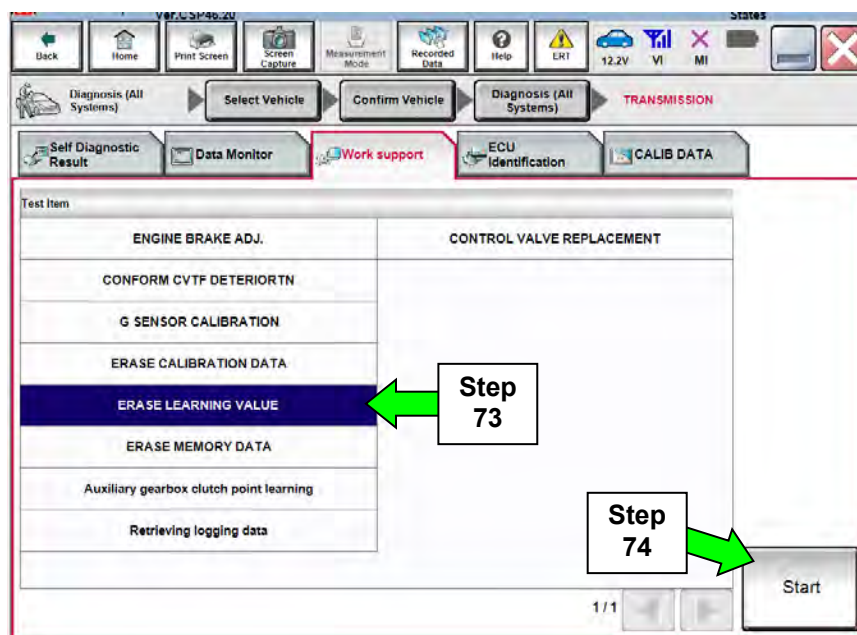

Figure 42

75. Follow the on-screen instructions; maintain the following conditions:

- a. Parking brake set.
- b. Ignition ON, with the engine OFF.
- c. Put shift selector in **R**.
- d. Fully depress the accelerator.

76. Select **Start**.

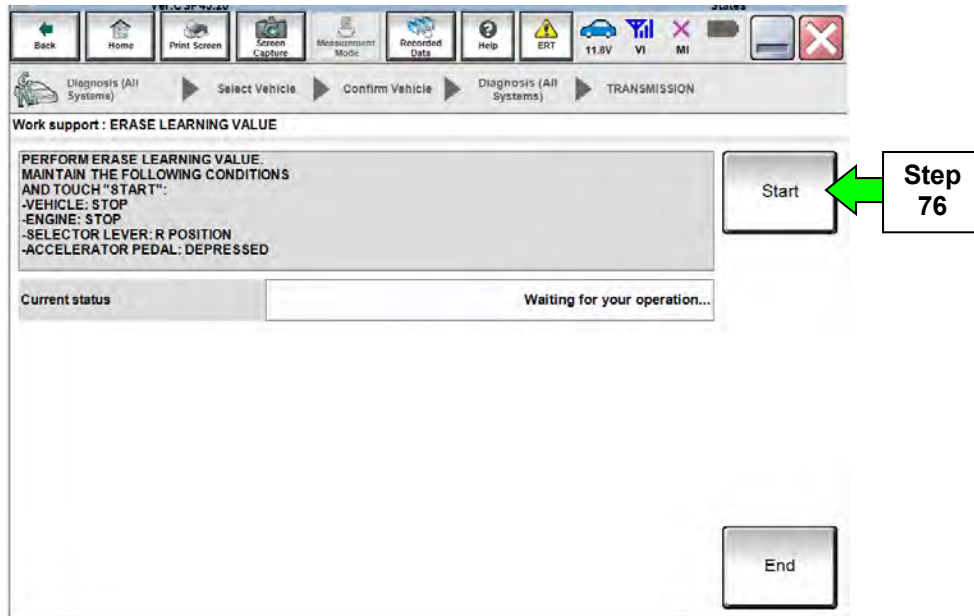

Figure 43

77. When COMPLETED is displayed, select **End**.

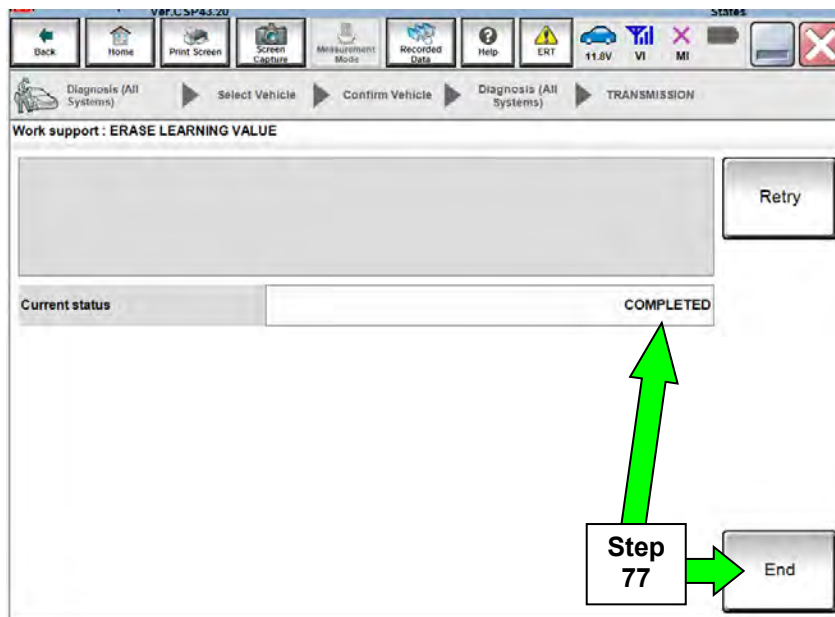

Figure 44

## CONFORM CVTF DETERIORTN

78. Navigate C-III plus to the screen shown in Figure 45.

- **Diagnosis (All Systems) > TRANSMISSION > Work support**

79. Select **CONFORM CVTF DETERIORTN**.

80. Select **Start**.

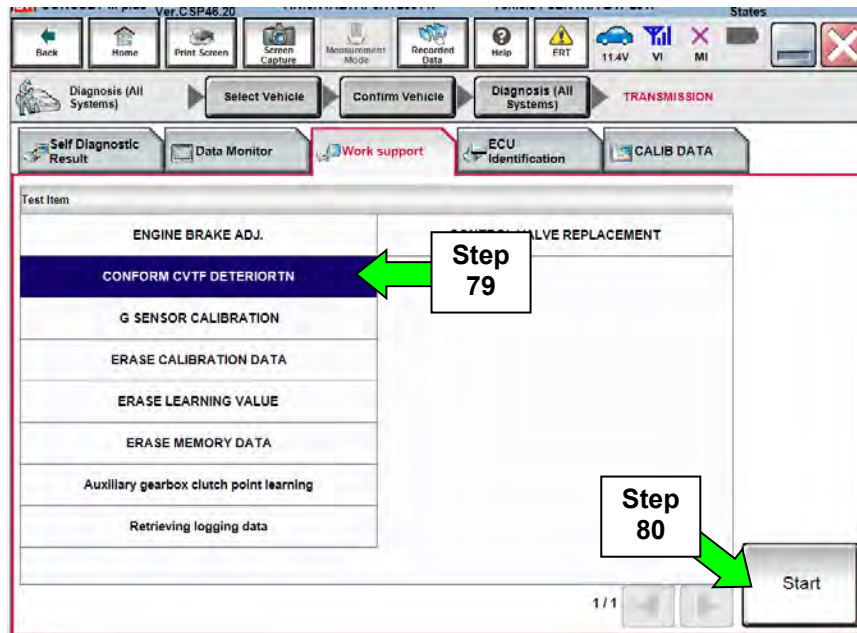

Figure 45

81. Select **Start**.

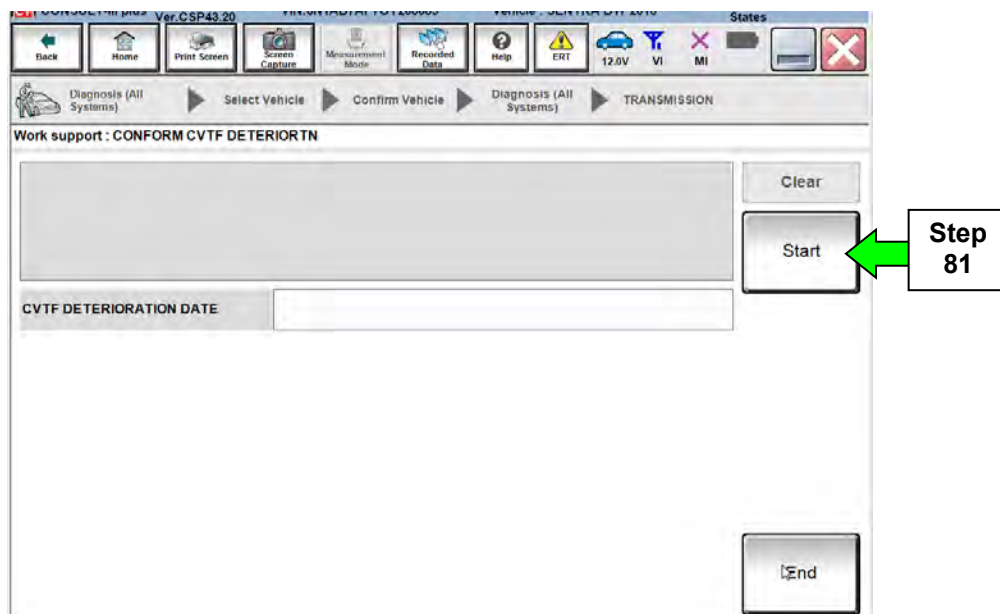

Figure 46

82. Select **Clear**.

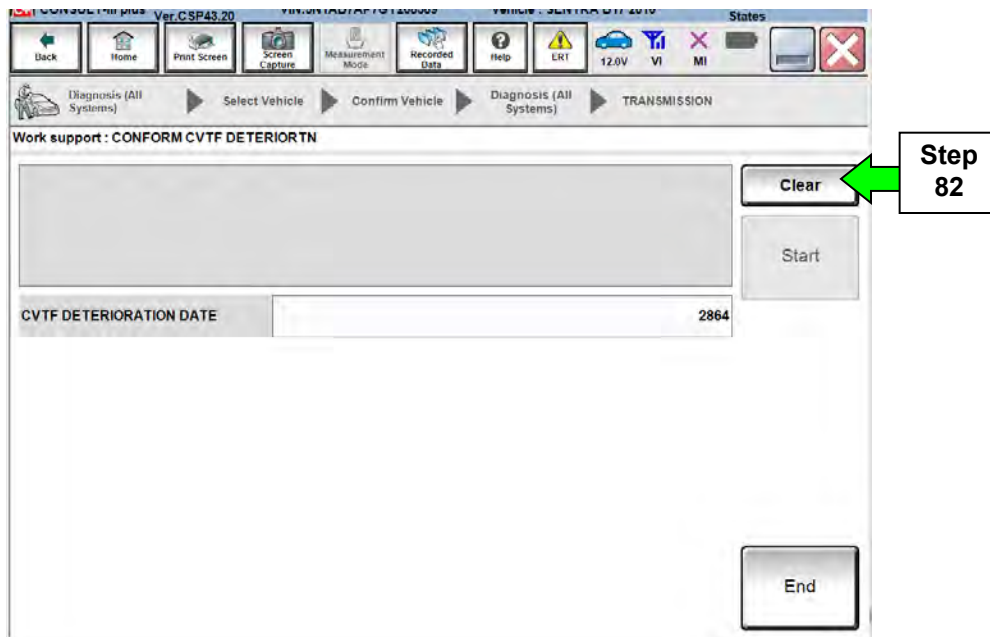

Figure 47

83. Select **Yes**.

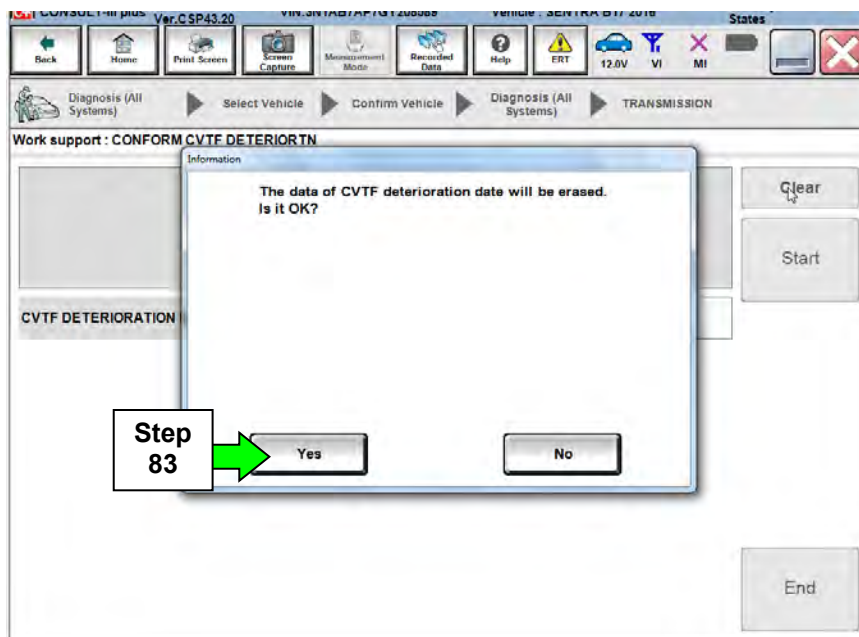

Figure 48

84. When **CVFT DETERIORATION DATE** changes to “0”, select **End**.

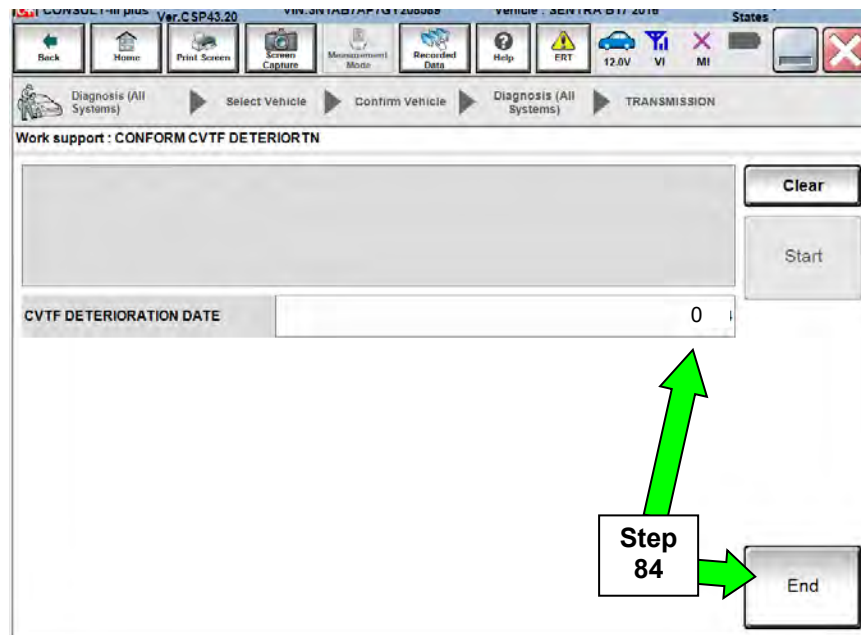

Figure 49

85. Start the engine.

86. Set the parking brake.

87. Turn OFF the A/C.

88. Bring the engine to normal operating temperature range.

89. Confirm the CVT fluid temperature is over 122°F (50°C).

## Auxiliary gearbox clutch point learning

90. Navigate C-III plus to the screen shown in Figure 50.

- **Diagnosis (All Systems) > TRANSMISSION > Work support**

91. Select **Auxiliary gearbox clutch point learning**.

92. Select **Start**.

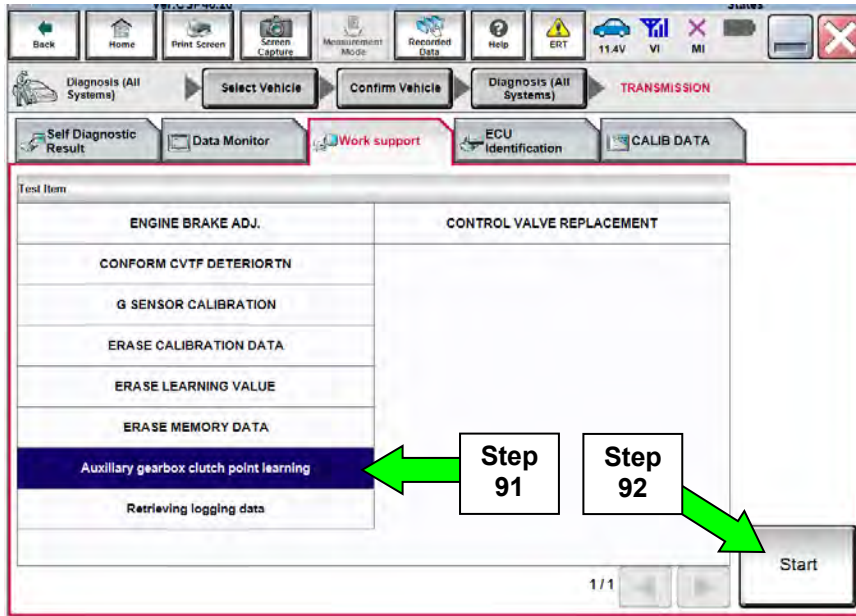

Figure 50

93. Follow the on-screen instructions in Figure 51 and then select **Start**.

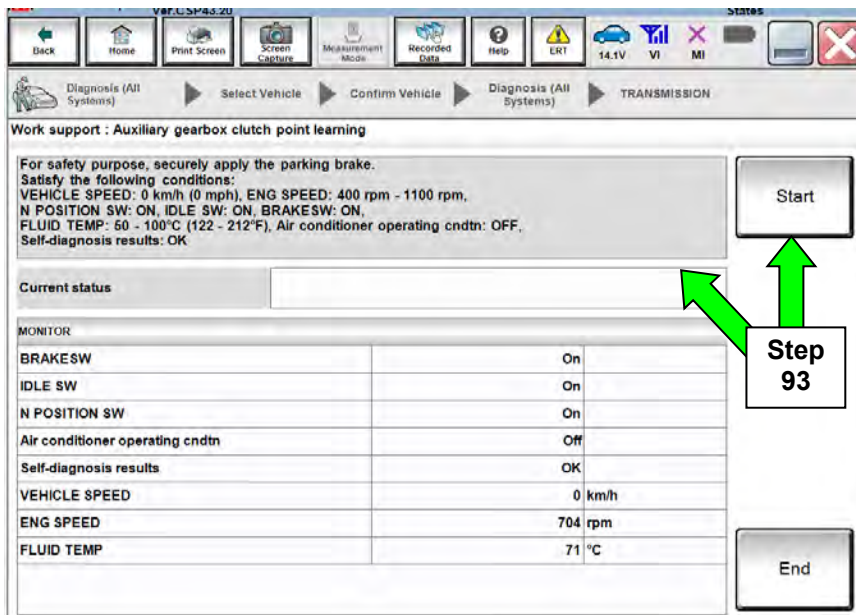

Figure 51



94. With brake pedal still applied, shift the CVT selector lever into the **D** position.

- Figure 52 will be displayed after shifting into **D** position.

**NOTE:** The Current status will show EXECUTING, but until the vehicle is shifted into the **D** position Auxiliary gearbox clutch point learning will not begin.

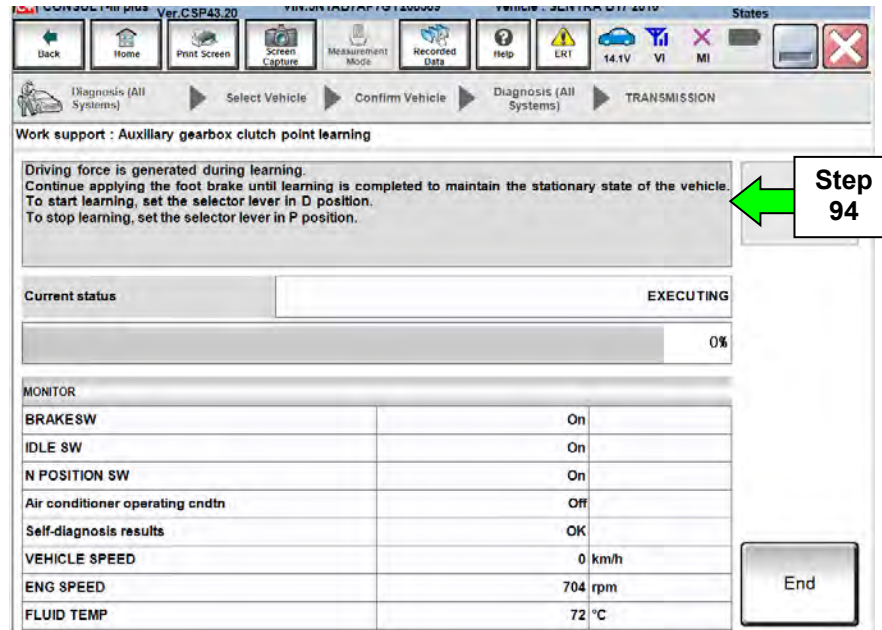

Figure 52

95. Continue to depress the brake pedal until the Current status shows “Completed” as shown in Figure 54 on the next page.

**NOTE:** This may take several minutes to complete.

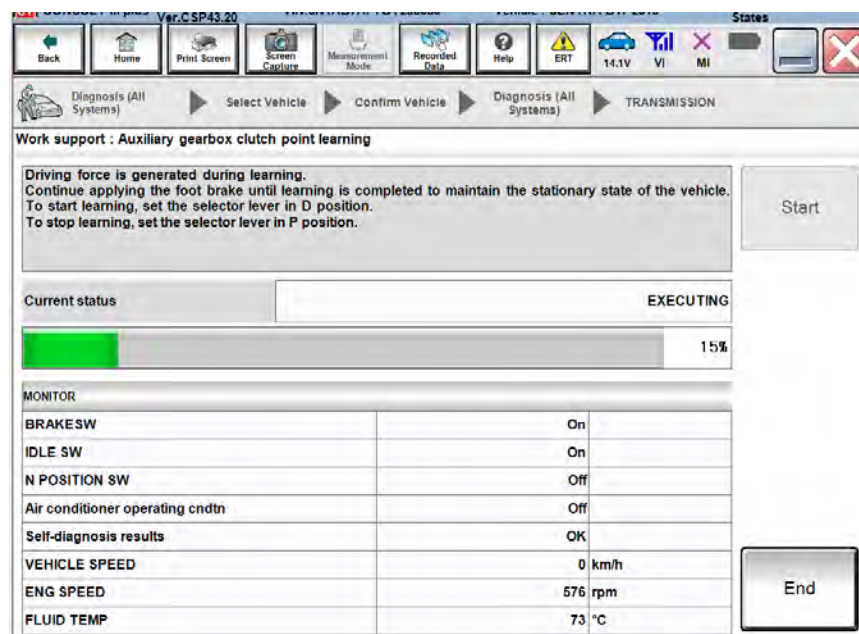

Figure 53

96. When COMPLETED is displayed, select **End**.

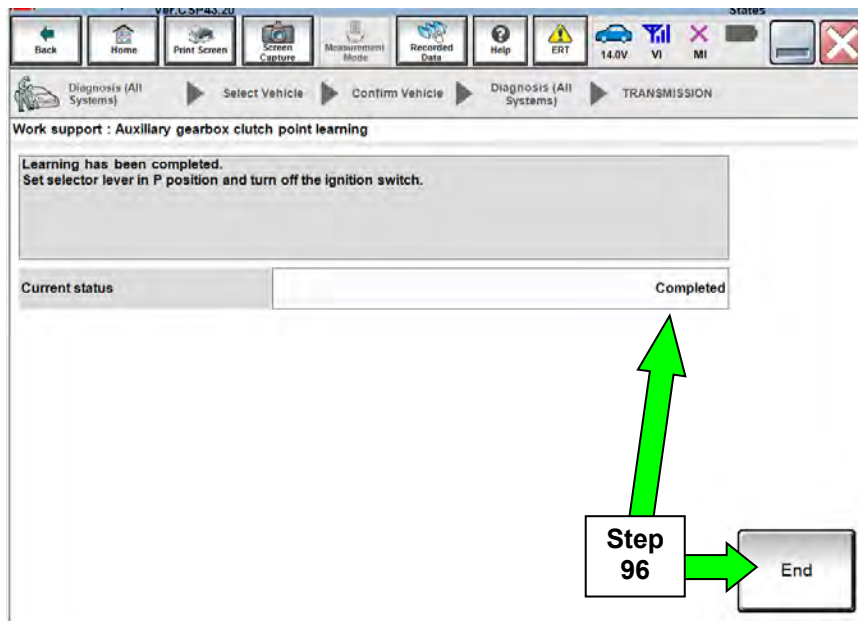

Figure 54

97. Shift the vehicle into Park, turn ignition OFF and release the brake pedal.

98. Perform Auxiliary Gearbox Clutch Point Learning (steps 85 to 97) one additional time (a total of two times).

### Erase DTCs

99. Use C-III plus to Erase any transmission DTCs that may have stored.

100. Turn OFF C-III plus.

101. Disconnect C-III plus from the vehicle.

102. Verify the CVT operates normally and no abnormal noises are heard during a test drive.

**Procedure complete.**

## PARTS INFORMATION

REPAIR	DESCRIPTION	PART #	QUANTITY
Sub-assembly Repair	KIT-CONTROL VALVE (For Sentra)	3170E-X428C	1
	KIT-CONTROL VALVE (For Versa Sedan or Versa NOTE)	3170E-X428B	
	KIT-PULLEY (For Sentra)	31214-3JX9A	1
	KIT-PULLEY (For Versa Sedan or Versa NOTE)	31214-X429B	
	KIT-OIL PUMP	31340-X429E	1
	Loctite 5460 Sealant (2) (4)	999MP-LT5460P	(1) (3)
Control Valve Replacement	KIT-CONTROL VALVE (For Sentra)	3170E-X428C	1
	KIT-CONTROL VALVE (For Versa Sedan and NOTE)	3170E-X428B	1
CVT Replacement	CVT Assembly (6)	(7)	1
Applies to all repairs	Nissan NS-3 CVT Fluid (1) (4)	999MP-CV0NS3	As needed
	Additional Engagement Tool O-Rings (5)	11440	As needed
	WASHER-DRAIN (CVT Oil Pan Drain Plug Gasket)	11026-JA00A	1
	Lens Swab packet	J-51963	(8)

- (1) Nissan NS-3 CVT Fluid and Loctite 5460 Sealant can be ordered through the Nissan Maintenance Advantage program: Phone: 877-NIS-NMA1 (877-647-6621) or Website: Order via link on dealer portal [www.NNAnet.com](http://www.NNAnet.com) and click on the "Maintenance Advantage" link.
- (2) One container of Loctite 5460 Sealant is good for approximately 5 repairs. This sealant is not included in any kit.
- (3) Bill out Loctite 5460 Sealant (or equivalent) under **expense code 008**. Do not include the Loctite 5460 Sealant part number on the claim.
- (4) For warranty repairs, Nissan NS-3 CVT Fluid and Loctite 5460 Sealant **must** be used. For customer pay repairs, Nissan NS-3 CVT and Loctite 5460 Sealant Fluid or their equivalents are recommended.
- (5) Engagement tool will initially come with 10 O-rings. Additional O-rings are available from Tech•Mate online: [www.nissantechmate.com](http://www.nissantechmate.com), or by phone: 1-800-662-2001.
- (6) If the CVT is being replaced, no other parts in the table above, except NS-3 CVT fluid or equivalent, are needed.
- (7) Refer to the Electronic Parts Catalog for the correct part number.
- (8) Shop supplies.

**CLAIMS INFORMATION**

Submit a Primary Part (PP) type line claim using the following claims coding:

If P17F0 is NOT stored, belt inspection is performed, and Sub-assembly is replaced (belt inspection shows signs of belt slip, NG)

OPERATION	PFP	OP CODE	SYM	DIA	FRT
CVT R&R	(1)	JD01AA JD023A	ZE	32	(2)
Inspect CVT Belt, Belt = <b>NG</b> (Includes control valve R&I)		JX36AA			1.2
Replace CVT Sub-assembly		JX45AA			3.0
Reprogram TCM		JE99AA			(2)

(1) Reference the Parts Information Table and use the Kit-Pulley Part Number as the Primary Failed Part (PFP).

(2) Reference the current Nissan Warranty Flat Rate Manual and use the indicated Flat Rate Time (FRT).

**OR**

If P17F0 IS stored and Sub-assembly is replaced (no belt inspection required)

OPERATION	PFP	OP CODE	SYM	DIA	FRT
CVT R&R	(1)	JD01AA JD023A	ZE	32	(2)
Replace Valve Body with P17F0 stored		JX56AA			0.8
Replace CVT Sub-assembly		JX45AA			3.0
Reprogram TCM		JE99AA			(2)

(1) Reference the Parts Information Table and use the Kit-Pulley Part Number as the Primary Failed Part (PFP).

(2) Reference the current Nissan Warranty Flat Rate Manual and use the indicated Flat Rate Time (FRT).

**EXPENSE CODE**

EXPENSE CODE	DESCRIPTION	MAX AMOUNT
008	Sealant	\$12.46

**CLAIMS INFORMATION continued on next page.**

## CLAIMS INFORMATION (continued)

**OR**

**Submit a Primary Part (PP) type line claim using the following claims coding:**

If pan inspection shows excessive large debris and CVT is replaced

OPERATION	PFP	OP CODE	SYM	DIA	FRT
Inspect CVT Pan for Excessive Debris = <b>NG</b>	(1)	JX49AA	ZE	32	0.3
Replace CVT		JD01AA JD023A			(2)

- (1) Reference the Electronic Parts Catalog and use the applicable CVT assembly part number as the Primary Failed Part (PFP).
- (2) Reference the current Nissan Warranty Flat Rate Manual and use the indicated Flat Rate Time (FRT).

**OR**

If P17F0 is **NOT** stored, belt inspection is performed, and only Control Valve is replaced (belt inspection shows NO signs of belt slip, OK)

OPERATION	PFP	OP CODE	SYM	DIA	FRT
Inspect CVT Belt, Belt = <b>OK</b>	(1)	JX37AA	ZE	32	0.4
Replace Valve Body		JD48AA			(2)
Reprogram TCM		JE99AA			(2)

- (1) Reference the Parts Information Table and use the Kit-Control Valve Part Number as the Primary Failed Part (PFP).
- (2) Reference the current Nissan Warranty Flat Rate Manual and use the indicated Flat Rate Time (FRT).

**NOTE:** FRT allows adequate time to access DTC codes. No other diagnostic procedures subsequently required. Do NOT claim any diagnostic OP Codes with this claim.

## KIT PARTS REFERENCE TABLE

### NOTE:

- This Table is for reference only. Part numbers listed cannot be ordered individually.
- These part numbers are for identification of the correct part within the kit (part number is listed on the bag for each individual part).
- Some parts have more than one part number listed. In this case, one of the part numbers listed will be in the kit.

### KIT-CONTROL VALVE (3170E-X428B or 3170E-X428C) PARTS REFERENCE (Kit Content)

REFERENCE #	DESCRIPTION	PART NUMBER	QTY:
1	VALVE ASSY – CONTROL (Control valve) <b>(For Sentra)</b>	31705-X428C or 31705-X429E or 31705-X422C	1
	VALVE ASSY – CONTROL (Control valve) <b>(For Versa Sedan or Versa NOTE)</b>	31705-X428B	
2	GASKET-OIL PAN (Oil pan gasket)	31397-3JX0A	1
3	STRAINER ASSY-OIL, AUTO TRANS (Oil pan strainer)	31728-3XX0A or 31728-3XX0B or 31728-3JX0B	1

### KIT-PULLEY (31214-3JX9A or 31214-X429B) PARTS REFERENCE (Kit Content)

REFERENCE #	DESCRIPTION	PART NUMBER	QTY:
4	PULLEY ASSY (Sub assembly: Belt & Pulley) <b>(For Sentra)</b>	31209-3JX9A or 31209-X429C	1
	PULLEY ASSY (Sub assembly: Belt & Pulley) <b>(For Versa Sedan or Versa NOTE)</b>	31209-X429B	
5	SNAP RING KIT (Snap ring kit)	31506-3JX8B	1
6	BOLT (Side cover bolts)	31377-3JX0E or 31377-X420B or 31377-3XX2B or 31377-X424C	11
7	SEAL-O RING (Input shaft O ring)	31526-3MX0A or 31526-X420C or 31526-3XX0C	1
8	SEAL – O RING	31526-8E000 or 31526-28X0C	2

## KIT PARTS REFERENCE TABLE (Continued)

### KIT-OIL PUMP (31340-X429E) PARTS REFERENCE (Kit Content)

REFERENCE #	DESCRIPTION	PART NUMBER	QTY:
9	BOLT (Torque converter case bolts)	31377-X420B or 31377-3JX0E or 31377-3XX2B or 31377-X424C	19
10	SEAL-LIP (Lip seal)	31528-1XZ0A or 31528-1XA01 or 31528-1XX0A	1
11	SEAL-O RING (Case O ring)	31526-X420B or 31526-50X0D or 31526-3JX0B or 31526-3XX0B	1
12	PIN-RET (Manual shaft roll pin)	31906-1XF0A	1
13	PUMP ASSY-OIL (Oil pump)	31340-X420B or 31340-3JX0D or 31340-X420A or 31340-3XX0B	1
14	GSKT-OIL PUMP (Oil pump gasket)	31366-3JX0B or 31366-3JX0A or 31366-3XX0A	1
15	SEAL-O RING (Oil filter cover O ring)	31526-3JX3A or 31526-3JX1B	1
16	FLTR ASSY-OIL,AUTO TRANS (Oil filter)	31726-28X0A or 31726-3JX0A or 31726-3XX0A	1
17	SEAL ASSY-OIL (Torque converter Seal)	31375-3JX1A	1
18	SEAL-OIL,DIFF (Axle seals)	38342-3VX0A	2
19	SEAL-O RING (Primary/Secondary/Output Sensor O-ring)	31526-1XG0C	3
20	SLEEVE-OIL DIST	31374 80X01	1
21	RING-SEAL	31525 3JX0B or 31525 X420A	2





## CVT Assembly Replacement Approval Procedures

- If CVT inspection **indicates CVT assembly replacement** is required:
  - a. Complete the PCC CVT Preauthorization Form in ASIST.
  - b. Attach the required video (15 seconds or less) to the CVT Preauthorization Form.
    - Failure to submit a continuous video showing evidence of abnormalities and the VIN will cause immediate denial of request for CVT unit replacement.
  - c. Call the PCC for authorization at **800-973-9992 (opt 2)**.

**IMPORTANT:** Make sure the video has a clear image of the VIN on the F.M.V.S.S. certification label (VIN label).

## AMENDMENT HISTORY

<b>PUBLISHED DATE</b>	<b>REFERENCE</b>	<b>DESCRIPTION</b>
April 26, 2017	NTB17-034	Original bulletin published.
June 2, 2017	NTB17-034a	Changes on pages 22, 27, 34, 43, 63, 91, and 103.
August 14, 2017	NTB17-034b	Changes on pages 2, 3, 9, 17, 23, 34, 35, 43, 44, 45, 83, 86 and 89 through 126.
October 10, 2017	NTB17-034c	APPLIED VEHICLES, PARTS INFORMATION, and CLAIMS INFORMATION sections revised, and changes on pages 94, 103, 116, 125, and 126.
November 20, 2017	NTB17-034d	Table B revised, and changes on pages 2, 6, 9 and 10.
February 1, 2018	NTB17-034e	APPLIED VEHICLE section and Table B revised, and changes to page 116.
August 10, 2018	NTB17-034f	Table B revised, and DTC added to If You Confirm.
November 14, 2018	NTB17-034g	Special tool added to page 6, and procedure to use the tool added to pages 77-79.
February 15, 2019	NTB17-034h	Title, Repair Overview, Table B, and IF YOU CONFIRM and CLAIMS INFORMATION sections revised. CONTROL VALVE REPLACEMENT and ERASE LEARNING VALUE procedures added. ERASE MEMORY DATA procedure removed. Change on page 11.
June 26, 2019	NTB17-034i	Table B revised.