

Technical Service Bulletin

Mazda North American Operations
Irvine, CA 92618-2922



Subject: CHECK ENGINE LIGHT ON WITH DTC P0300:00, P0301:00, P0302:00, P0303:00, AND/OR P0304:00	Bulletin No.: 01-012/19
	Last Issued: 07/02/2019

BULLETIN NOTES

This bulletin supersedes the previously issued bulletin(s) listed below. The changes are noted in Red.

Previously issued TSBs:	Date issued:
01-020/15	08/18/15

APPLICABLE MODEL(S)/VINS

2012-2013 Mazda3 (with SKYACTIV)

DESCRIPTION

Some vehicles may experience the Check Engine Light ON with DTC P0300:00, P0301:00, P0302:00, P0303:00 and/or P0304:00 stored in memory.

- P0300:00: Random misfire detected
- P0301:00: Cylinder No.1 misfire detected
- P0302:00: Cylinder No.2 misfire detected
- P0303:00: Cylinder No.3 misfire detected
- P0304:00: Cylinder No.4 misfire detected

Carbon may be deposited around the intake valves, resulting in unstable engine combustion and misfiring during the accelerated warm-up system (AWS) operation.

Customers having this concern should have their vehicle repaired using the following repair procedure.

CONSUMER NOTICE: The information and instructions in this bulletin are intended for use by skilled technicians. Mazda technicians utilize the proper tools/equipment and take training to correctly and safely maintain Mazda vehicles. These instructions should not be performed by "do-it-yourselfers." Customers should not assume this bulletin applies to their vehicle or that their vehicle will develop the described concern. To determine if the information applies, customers should contact their nearest authorized Mazda dealership. Mazda North American Operations reserves the right to alter the specifications and contents of this bulletin without obligation or advance notice. All rights reserved. No part of this bulletin may be reproduced in any form or by any means, electronic or mechanical---including photocopying and recording and the use of any kind of information storage and retrieval system ---without permission in writing.

REPAIR PROCEDURE

1. Check the FFD and verify that it meets the following conditions.
 - One or more snapshots exist for P0300, P0301, P0302, P0303 or P0304
 - (LOAD_C) : Above 70%
 - (ECT) : Below 100 °F
 - (RPM) : Above 1300 RPM
 - (VSS) : = 0 MPH
 - (SPARKADV) : -21 to -8
 - (EG_RUN_TIME) : Below 00:45
 - If it meets the following conditions, go to next step.
 - If it does not meet the following conditions, follow the instructions for the DTC on MGSS.
2. Decarbon the intake valves **using a commercially available Top End Decarbon solvent**.
 - a. Remove the intake manifold and spark plugs.

NOTE: DO NOT disconnect the negative battery cable to keep the misfire count active.

CAUTION: Take care not to break the harness clips.

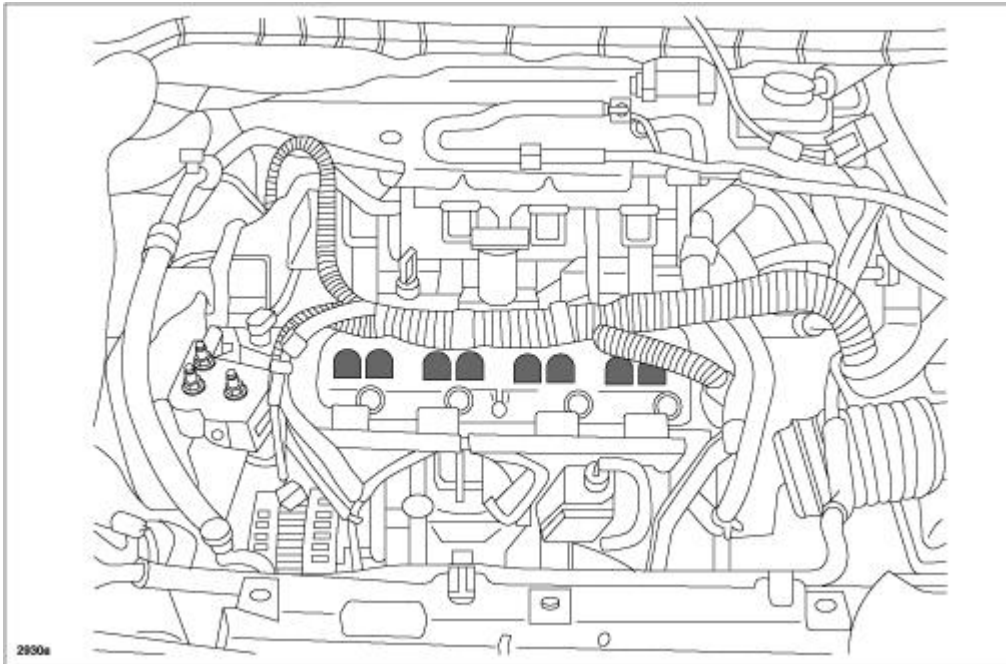

- b. Check for carbon deposit around the intake valves.

c. Spread shop towels under the intake ports to protect components from cleaner overflow.

CAUTION: Take care not to damage the alternator.

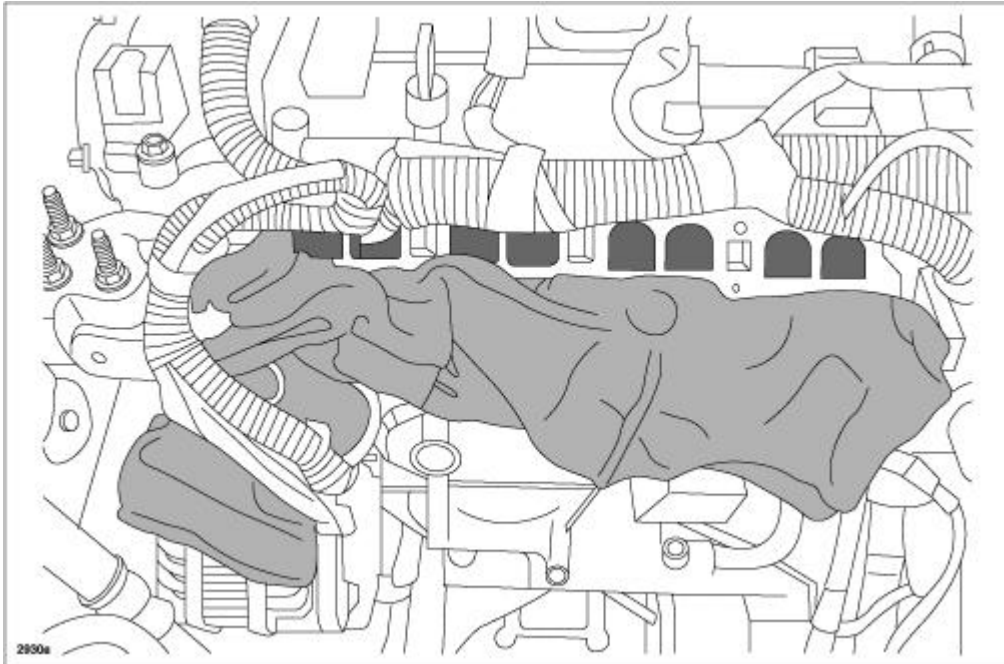

d. Raise the vehicle and remove the right-front splash shield to access the crankshaft pulley (A).

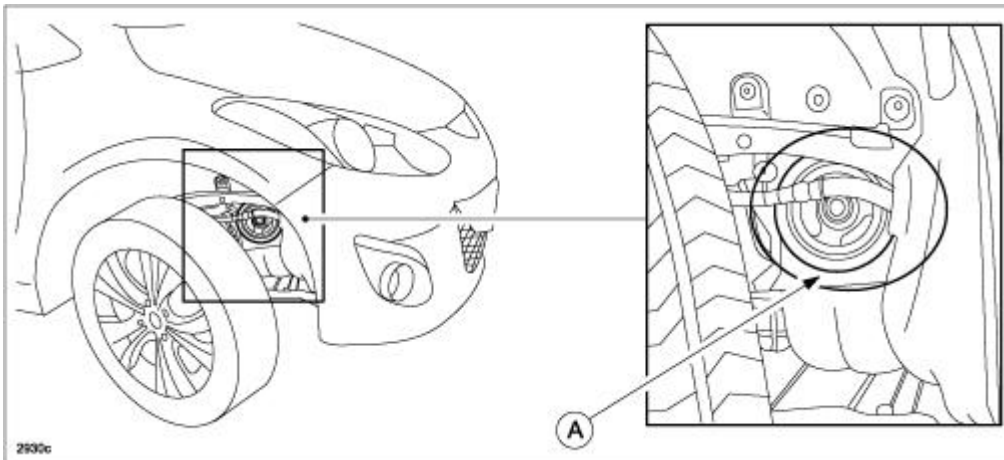

CONSUMER NOTICE: The information and instructions in this bulletin are intended for use by skilled technicians. Mazda technicians utilize the proper tools/equipment and take training to correctly and safely maintain Mazda vehicles. These instructions should not be performed by "do-it-yourselfers." Customers should not assume this bulletin applies to their vehicle or that their vehicle will develop the described concern. To determine if the information applies, customers should contact their nearest authorized Mazda dealership. Mazda North American Operations reserves the right to alter the specifications and contents of this bulletin without obligation or advance notice. All rights reserved. No part of this bulletin may be reproduced in any form or by any means, electronic or mechanical---including photocopying and recording and the use of any kind of information storage and retrieval system ---without permission in writing.

- e. Perform the following to determine piston location and valve opening during cleaning.
- When mark A is located at TDC, the intake valves are closed at cylinders #1 and #4.
 - When mark B is located at TDC, the intake valves are closed at cylinders #2 and #3.
- i. Rotate engine to TDC.
- ii. Add a paint mark "A" to the pulley face at TDC.
- iii. Add another paint mark "B" to the pulley face 180 degrees opposite from TDC mark (M).

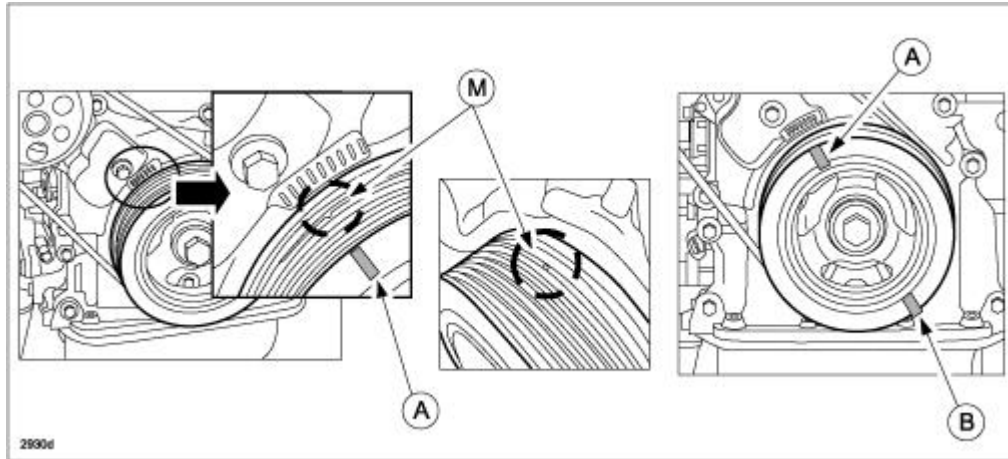

- f. Clean the intake valves of cylinders #1 and #4 with mark A at TDC.
- i. Spray the cleaner fluid onto carbon deposit around the intake valves until fully covered (A) and let soak for 2 hours.

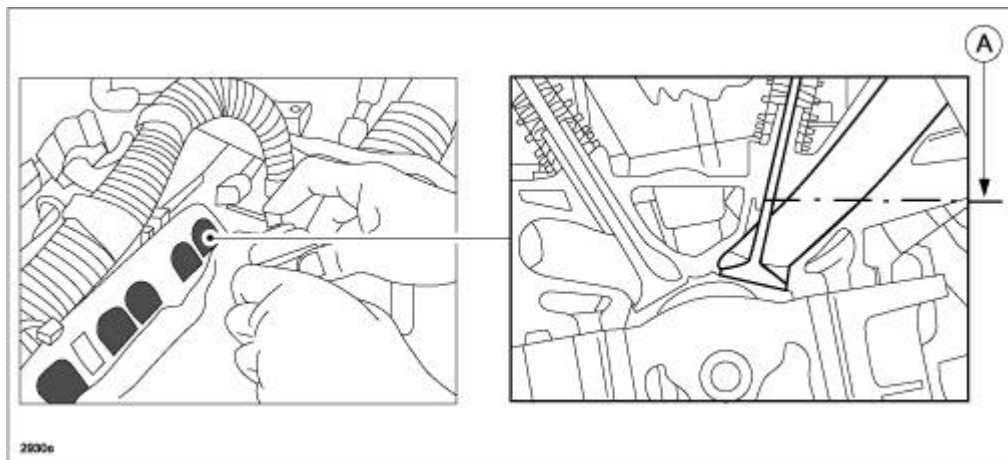

- ii. Soak up the cleaner fluid with shop towels or a temporary suction tool.

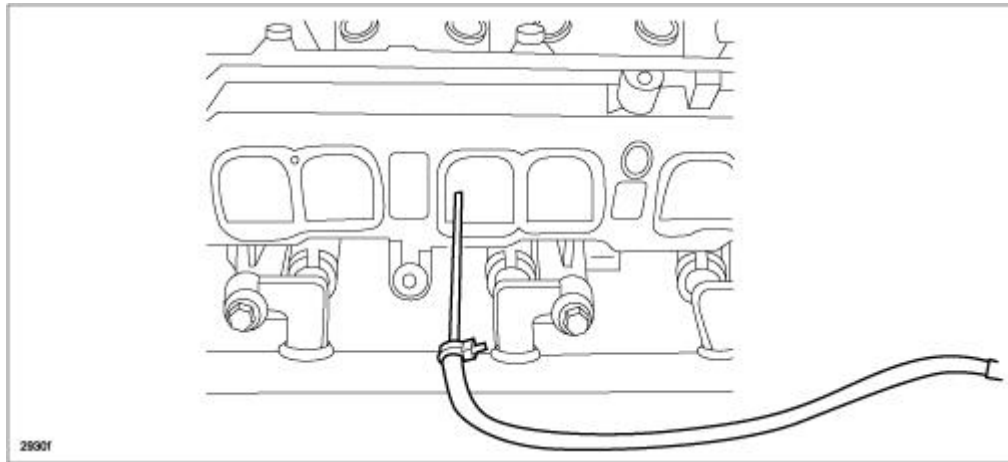

- iii. Scrape the carbon deposits off of the stems and intake valves using shop towels and an appropriate plastic or wooden stick.

CAUTION: DO NOT use a metal tool in order to avoid valve damage.

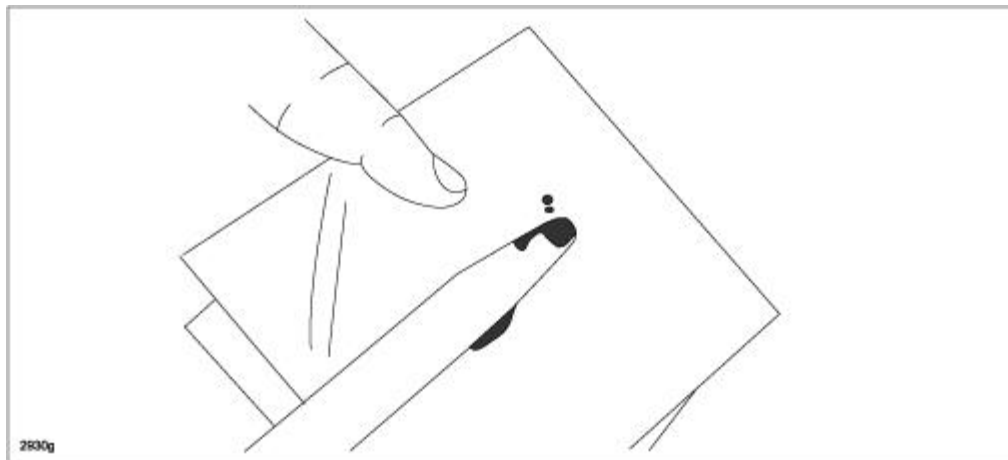

CONSUMER NOTICE: The information and instructions in this bulletin are intended for use by skilled technicians. Mazda technicians utilize the proper tools/equipment and take training to correctly and safely maintain Mazda vehicles. These instructions should not be performed by "do-it-yourselfers." Customers should not assume this bulletin applies to their vehicle or that their vehicle will develop the described concern. To determine if the information applies, customers should contact their nearest authorized Mazda dealership. Mazda North American Operations reserves the right to alter the specifications and contents of this bulletin without obligation or advance notice. All rights reserved. No part of this bulletin may be reproduced in any form or by any means, electronic or mechanical---including photocopying and recording and the use of any kind of information storage and retrieval system ---without permission in writing.

- iv. Wipe out the scraped deposits with shop towels and the plastic or wooden stick.

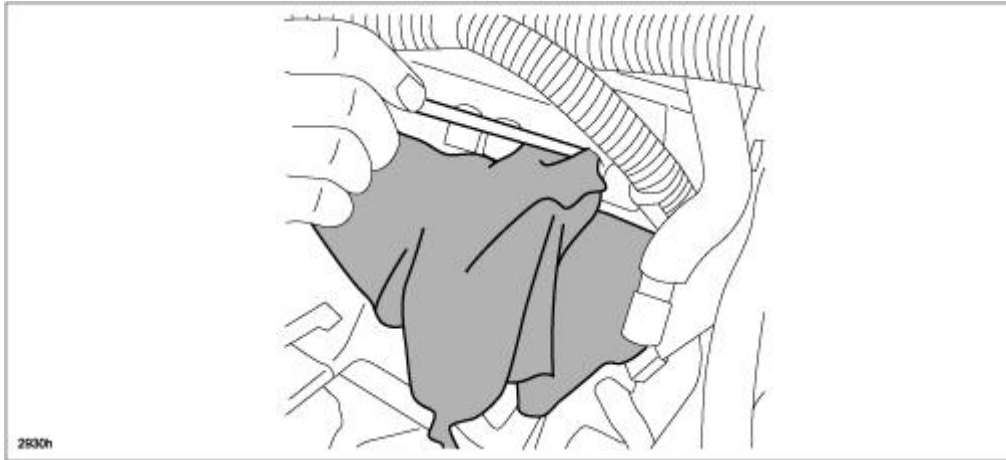

- h. Clean the intake valves of cylinders #2 and #3 with mark B at TDC by repeating step No.5.
- i. Clean the cylinder head to intake manifold sealing surfaces.
- j. Reassemble the intake manifold and the other remaining parts.
- k. Crank the engine with the accelerator pedal fully depressed (Dechoke mode) for 10 seconds. Repeat this twice in order to clear the remaining materials in the ports.

NOTE: Dechoke mode cancels fuel injection during cranking (when the accelerator pedal is fully depressed).

- l. Start the engine and keep the engine idling until the water temperature light shuts off.

CAUTION: White smoke may occur, therefore prepare the exhaust vacuum duct or perform this step in a well ventilated area.

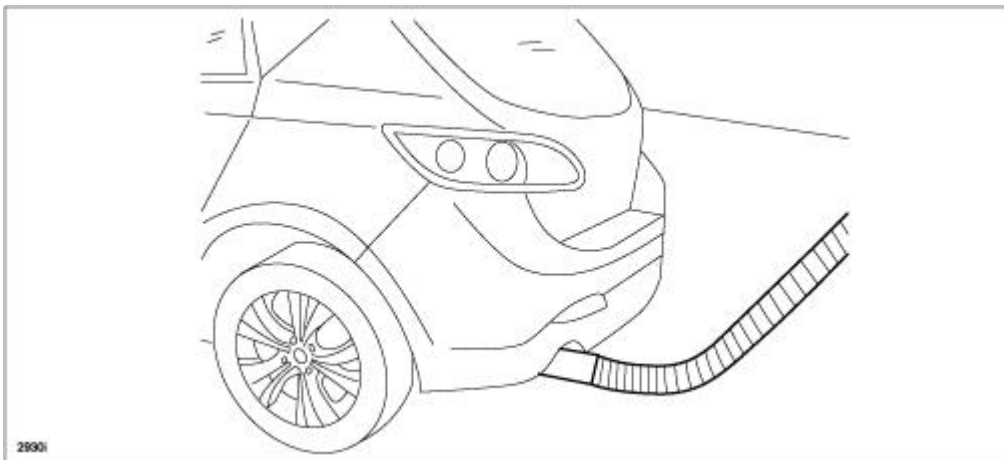

CONSUMER NOTICE: The information and instructions in this bulletin are intended for use by skilled technicians. Mazda technicians utilize the proper tools/equipment and take training to correctly and safely maintain Mazda vehicles. These instructions should not be performed by "do-it-yourselfers." Customers should not assume this bulletin applies to their vehicle or that their vehicle will develop the described concern. To determine if the information applies, customers should contact their nearest authorized Mazda dealership. Mazda North American Operations reserves the right to alter the specifications and contents of this bulletin without obligation or advance notice. All rights reserved. No part of this bulletin may be reproduced in any form or by any means, electronic or mechanical---including photocopying and recording and the use of any kind of information storage and retrieval system ---without permission in writing.

m. Race the engine from idle to 6000 rpm by fully depressing the accelerator pedal 20 times in order to clear the remaining deposits and cleaner fluid.

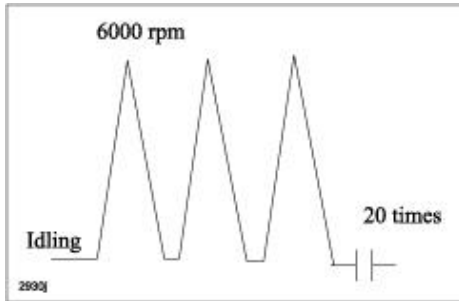

n. Stop the engine and replace the engine oil and filter.

3. Reboot the IDS to clear memory before reprogramming.

4. Using IDS 96.04 or later software, reprogram the PCM to the latest calibration (refer to “Calibration Information” table) by following the “Module Reprogramming” procedure.

NOTE:

- Always update the IDS tool first, then follow on-screen instructions to download the needed calibration file for PCM reprogramming.
- It is not necessary to remove any fuses or relays during PCM reprogramming when the IDS screen prompts you to do so. You may accidentally stop power to one of the PCM terminals and cause the PCM to be blanked, or you may receive error messages during the IDS reprogramming procedure.
- IDS shows the calibration part numbers after programming the PCM.
- Please be aware that PCM calibration part numbers and file names listed in any Service Bulletin may change due to future releases of IDS software, and additional revisions made to those calibrations for service related concerns.
- When reprogramming a PCM, IDS will always display the “latest” calibration P/N available for that vehicle. If any calibration has been revised/updated to contain new information for a new service concern/issue, it will also contain all previously released calibrations.
- When performing this procedure, we recommend using the “Power Supply” mode in the Battery Management System to keep the vehicle battery up to capacity. If a different charger is used, make sure it does not exceed 20 AMPS. If it exceeds 20 AMPS, it could damage the VCM.

5. After performing the PCM reprogramming procedure, verify the repair by starting the engine and making sure there is no Check Engine Light ON or abnormal warning lights present.

NOTE:

- If any DTCs should remain after performing DTC erase, diagnose the DTCs using MGSS online instructions or Workshop Manual section 01-02.
- After PCM reprogramming, it is no longer necessary to road test the vehicle to “relearn” KAM (Keep Alive Memory).

CALIBRATION INFORMATION

Spec.	Transmission	File Name
CALIF ULEV	A/T	PSZH-188K2-B
	M/T	PSZG-188K2-B
FED/CANADA	A/T	PSZK-188K2-B
	M/T	PSZJ-188K2-B
CALIF PZEV	A/T	PE08-188K2-W
	M/T	PUYG-188K2

NOTE: It is not necessary to order a PCM part for this repair procedure.

PARTS INFORMATION

Part Number	Description	Qty.
PE01-13-111	Gasket, Inlet Manifold	4
PE01-13-655	Gasket, Throttle Body	1

WARRANTY INFORMATION

NOTE:

- This warranty information applies only to verified customer complaints on vehicles eligible for warranty repair.
- This repair will be covered under Mazda's Federal Emission Warranty (long term) or CA PZEV Emission Warranty.
- Additional diagnostic time cannot be claimed for this repair.

Warranty Type	A
Symptom Code	6X
Damage Code	93
DTC Code	P0300, P0301, P0302, P0303 or P0304
Part Number Main Cause	5555-RP-PCM
Quantity	0
Operation Number / Labor Hours	XXK7JXFX / 2.7 Hrs.

NOTE: Claim the engine oil (4.2 US qt {4.0 L, 3.5 Imp qt}) and oil filter as a related part.

CONSUMER NOTICE: The information and instructions in this bulletin are intended for use by skilled technicians. Mazda technicians utilize the proper tools/equipment and take training to correctly and safely maintain Mazda vehicles. These instructions should not be performed by "do-it-yourselfers." Customers should not assume this bulletin applies to their vehicle or that their vehicle will develop the described concern. To determine if the information applies, customers should contact their nearest authorized Mazda dealership. Mazda North American Operations reserves the right to alter the specifications and contents of this bulletin without obligation or advance notice. All rights reserved. No part of this bulletin may be reproduced in any form or by any means, electronic or mechanical---including photocopying and recording and the use of any kind of information storage and retrieval system ---without permission in writing.