



SERVICE BULLETIN

ing

Classification: BT15-037a	Reference: NTB16-017a	Date: August 12, 2019
------------------------------	--------------------------	--------------------------

MOONROOF ADJUSTMENT AND REPAIRS

This bulletin has been amended. See Amendment History on the last page.
Please discard previous versions of this bulletin.

APPLIED VEHICLE: 2016 – 2019 Maxima (A36)

SERVICE INFORMATION

When working on the Moonroof, most items can be replaced, repaired, or adjusted, without the need to replace the entire Moonroof assembly.

Refer to the following procedures in this bulletin, as needed, to help resolve Moonroof issues.

- **Knock Insert (Knock) Replacement (Page 2)**
IMPORTANT: Knocks that are out of place may lodge in the track and prevent correct Moonroof, wind deflector, or sunshade operation. Before any other adjustments or repairs are performed, the Knocks should be checked.
- **Wind Deflector Replacement (Page 7)**
For wind deflector being damaged, scratched, or having a broken clip.
- **Roof Finisher Replacement (Page 13)**
For roof finisher being damaged, having seal issues, roof finisher not being seated, or Moonroof rattle.
- **Moonroof Glass Adjustment (Page 21)**
For adjusting fit, tightening loose screws or for glass being out of position.
- **Front or Rear Sunshade Replacement (Page 29)**
For sunshade replacement due to discoloration, being jammed, out of track, loss of tension or popping/clicking while in motion.
- **Moonroof or Sunshade Motor and Drive Cable Replacement (Page 33)**
For inoperative or noisy.
- **Rear Link Replacement (Page 36)**
For rattle noise when opening or closing the Moonroof **OR** when driving with Moonroof **NOT CLOSED** (open or tilt position).

IMPORTANT: Do not lower the headliner unless instructed.

- If the headliner is lowered, allow it to rest on the seats. Do not remove the headliner from the vehicle.

Nissan Bulletins are intended for use by qualified technicians, not 'do-it-yourselfers'. Qualified technicians are properly trained individuals who have the equipment, tools, safety instruction, and know-how to do a job properly and safely. NOTE: If you believe that a described condition may apply to a particular vehicle, DO NOT assume that it does. See your Nissan dealer to determine if this applies to your vehicle.

SERVICE PROCEDURE

“Knock Insert” (Knock) Inspection (same for left or right side)

IMPORTANT:

- Detached knocks (Knock shown in Figure 1) may lodge in the Moonroof track and prevent correct Moonroof, wind deflector, or sunshade operation.
- Do not remove the headlining for “knock” inspection or replacement.
- Knocks are available only as part of a left or right side specific Moonroof cable repair kit and are listed as GUIDE ASSY-SUNROOF in the PARTS INFORMATION table.

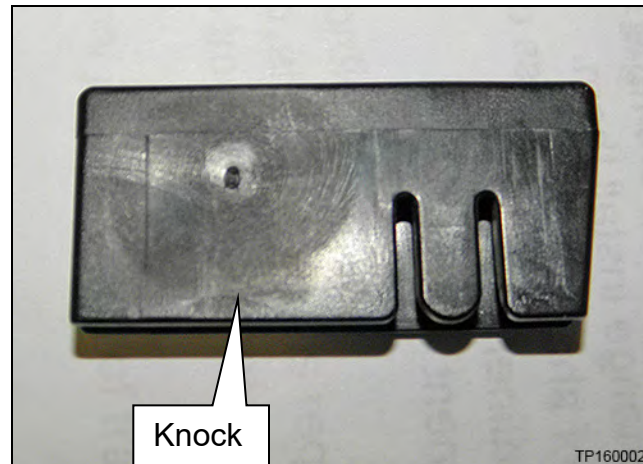

Figure 1

1. Turn the ignition ON, but do not start engine.
2. Completely open the Moonroof.
3. Remove the left and right inner blinds (Figure 2).
 - a. Unclip the left and right inner blinds at the front corners of the “Moonroof unit assembly” (Moonroof frame) with an appropriate tool.
 - b. Rotate the inner blind to release the remaining clip.

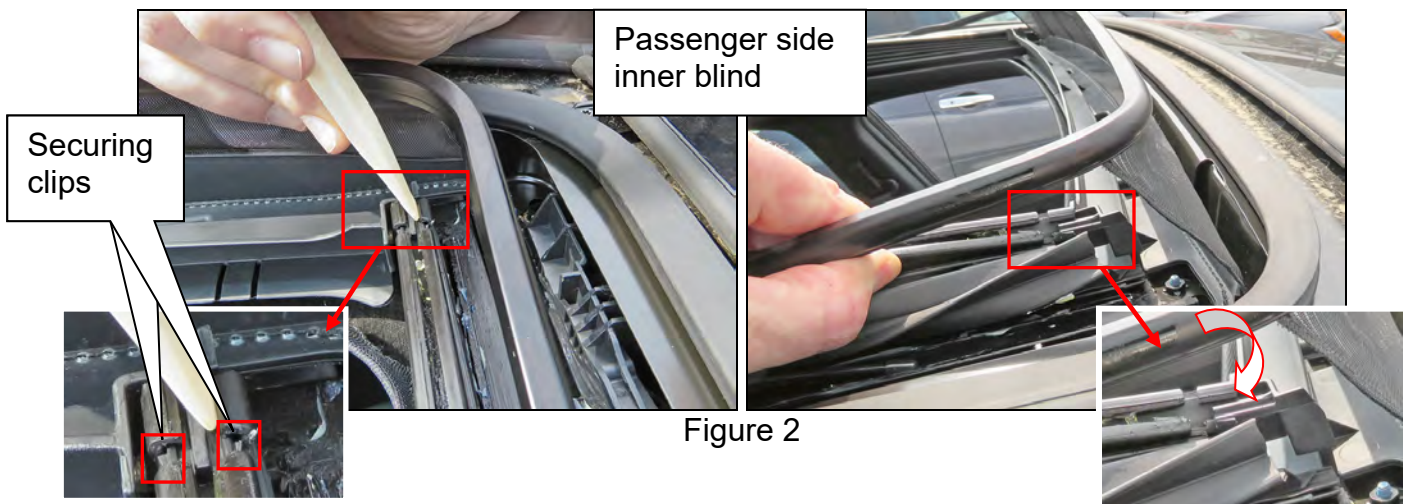

Figure 2

NOTE: Figure 3 shows the inner blind unclipped.

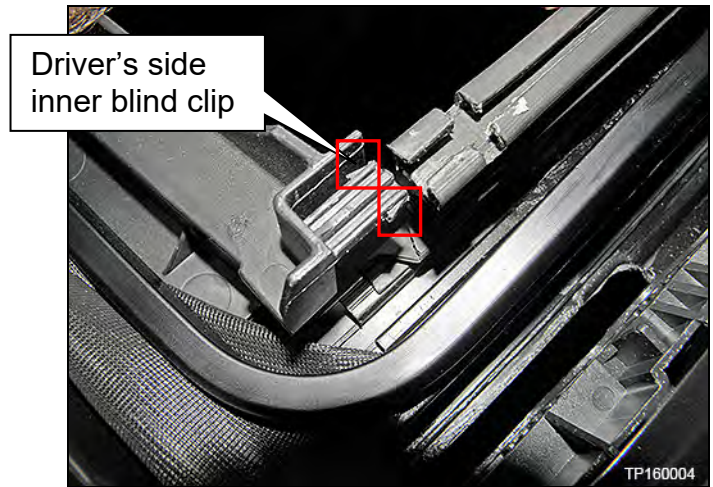

Figure 3

- c. Carefully detach the inner blinds from the Moonroof frame by pushing toward the inside of the vehicle along the bottom edge of inner blind (Figure 4).

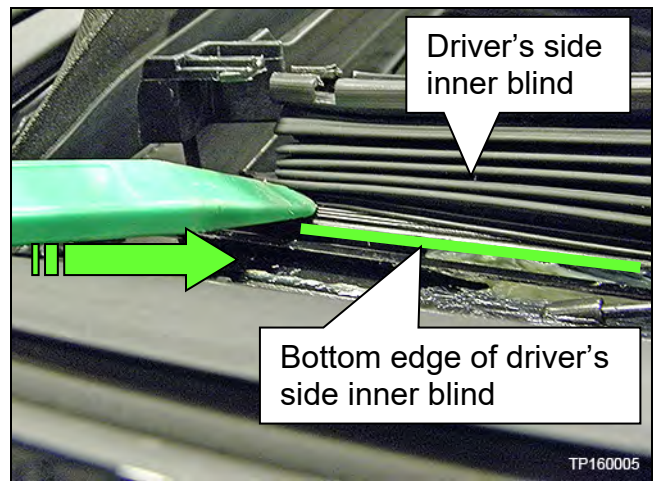

Figure 4

- d. Slide each inner blind toward the front of the vehicle and off of the Moonroof guides (Figure 5).

NOTE: Figure 5 is shown from inside the vehicle.

- 4. Close the Moonroof half way.

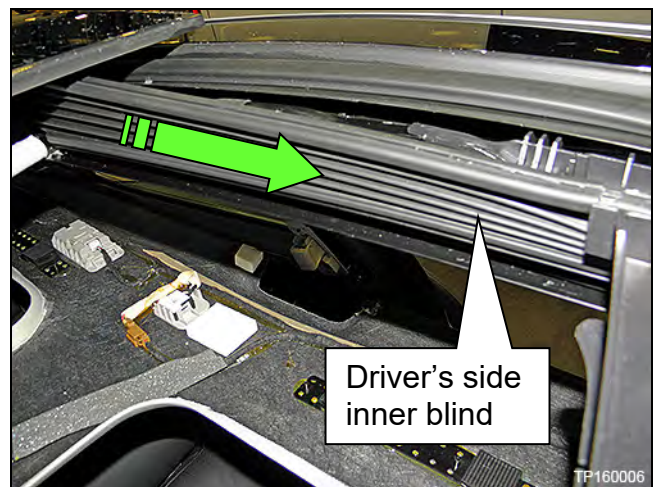

Figure 5

5. Confirm that both left and right knocks are present and correctly seated (Figure 6).
 - If both knocks are present, confirm that they are completely seated and lock clips locked in place (Figure 7).
 - If both knocks are present and completely seated no further action is required.
 - If a knock is present, but not completely seated (Figure 8), proceed to step 6 and replace only the unseated knock.
- NOTE:** Do not attempt to seat a knock that is out of place.
- If one of the knocks is missing, proceed to step 6 and replace both the left and right knocks.

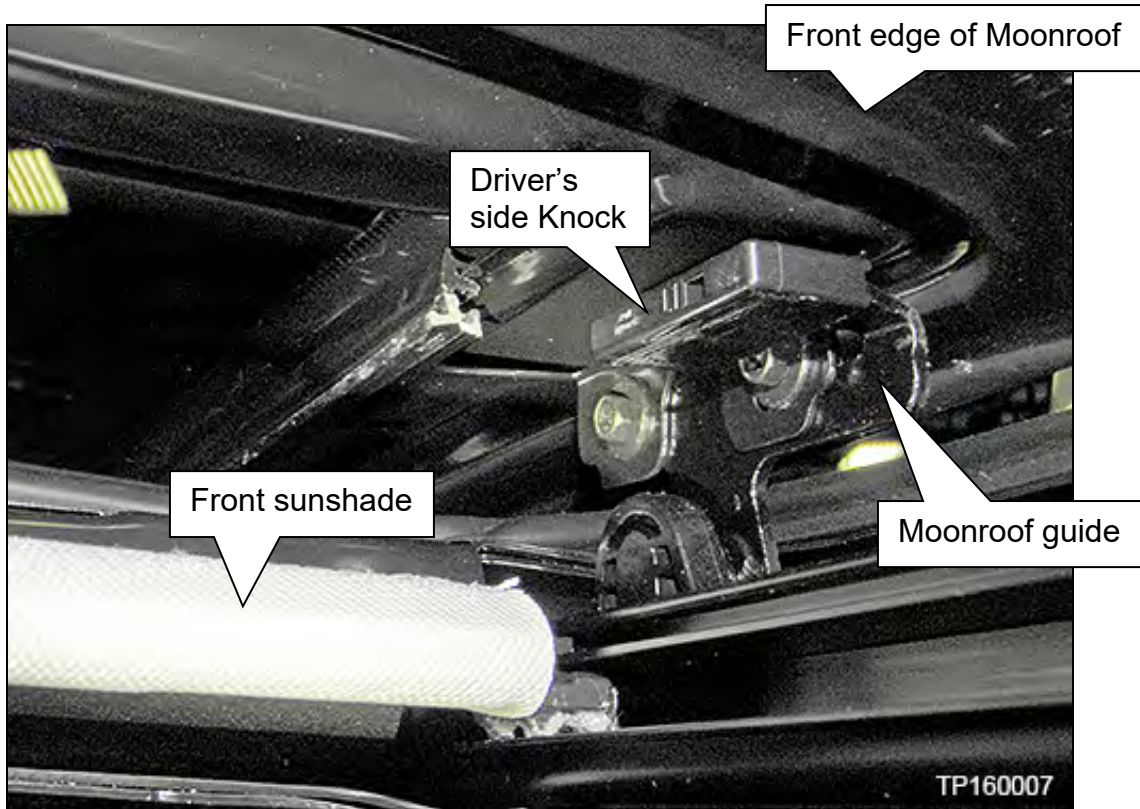

Figure 6

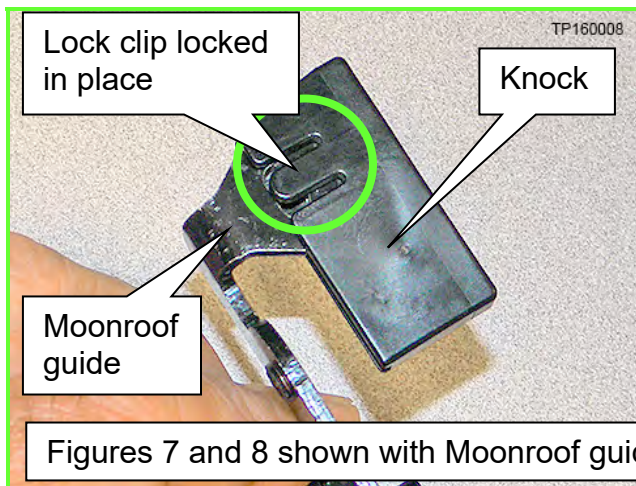

Figure 7



Figure 8

Figures 7 and 8 shown with Moonroof guide unbolted from Moonroof frame for clarity.

6. Remove the affected knock(s) (Figure 9).
 - a. Lift the knock lock clip with a finesse tool vertically away from the Moonroof guide.
 - b. Slide the knock toward the inside of the vehicle.

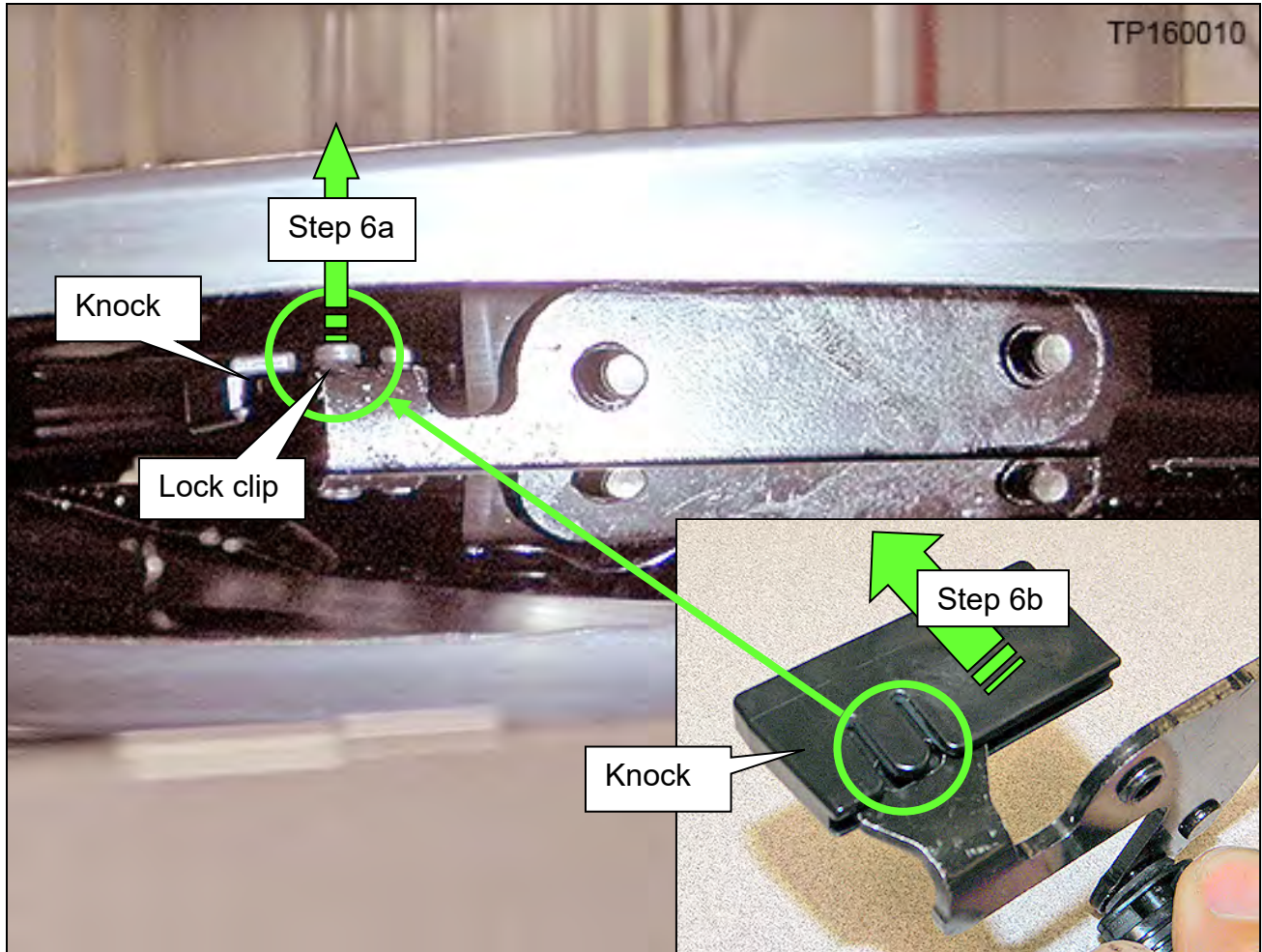

Figure 9

7. Install new knock(s) for those affected.
 - When installing a new knock; listen for an audible snap and then confirm that the lock clip is flush.

NOTE: Knocks are marked left (L) and right (R). Figure 10 shows a knock for the passenger side and is marked "R".

8. Pull on the knock to confirm that it is completely seated on the Moonroof guide.

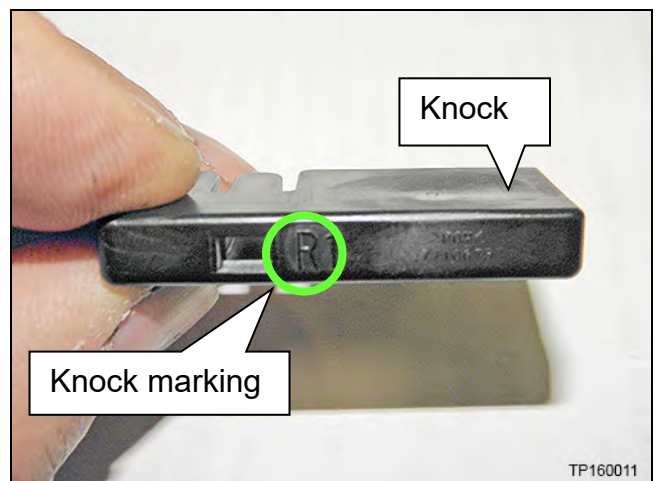

Figure 10

9. Reinstall the left and right inner blinds.

a. Slide the top of the left and right inner blinds onto their guides (Figure 11).

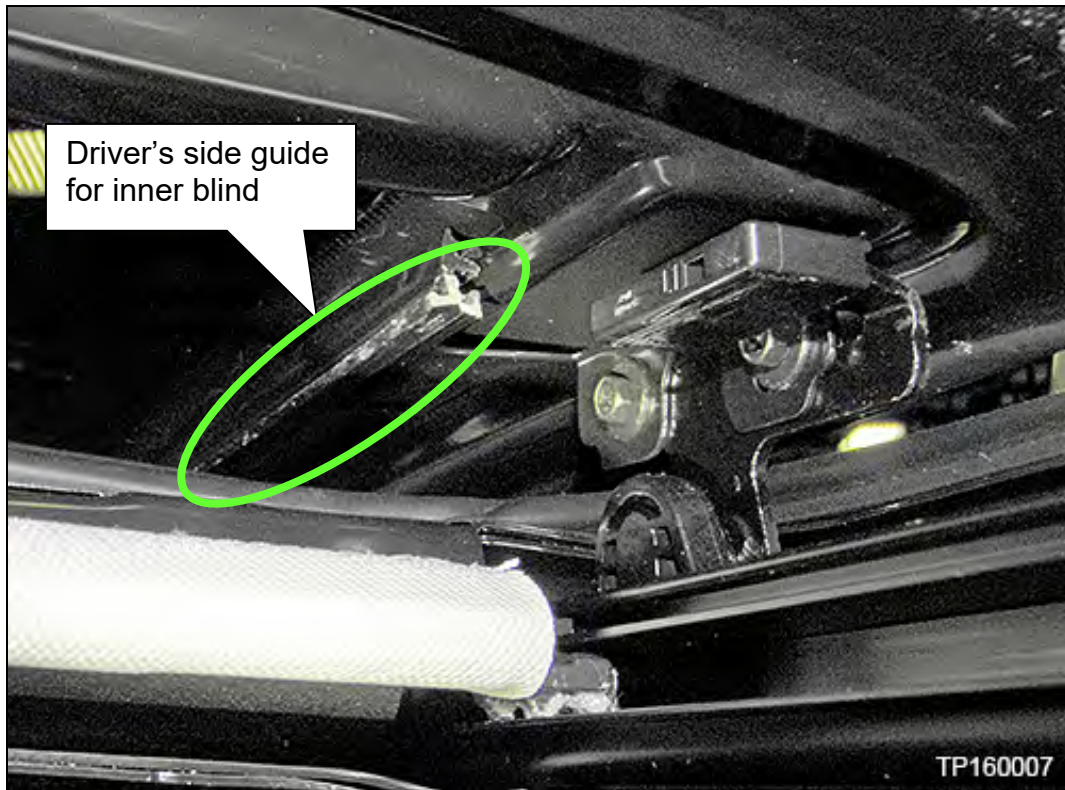

Figure 11

b. Reconnect the front clip of the inner blind to the front corner of the Moonroof frame.

c. Attach the bottom of the inner blinds to the Moonroof frame.

10. Close the Moonroof.

11. Turn the ignition OFF.

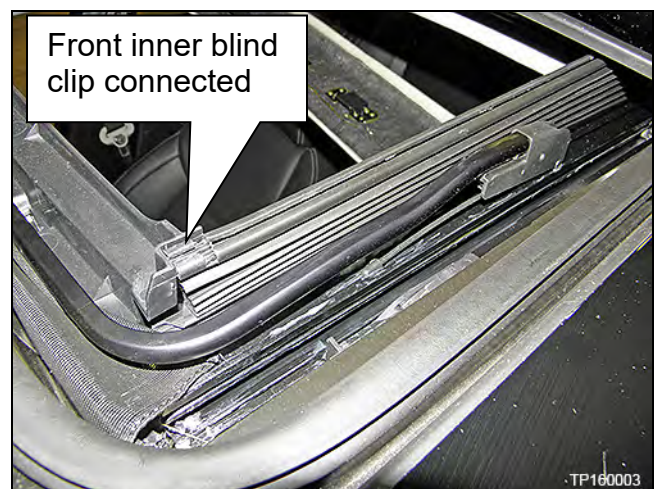

Figure 12

Wind Deflector Replacement

If the wind deflector is damaged, scratched, or has a broken clip follow the steps below.

IMPORTANT: Do not lower the headlining to repair wind deflector.

Removal

1. Remove the left and right inner blinds (Figure 13).
 - a. Unclip the left and right inner blinds at the front corners of the “Moonroof unit assembly” (Moonroof frame) with an appropriate tool.
 - b. Rotate the inner blind to release the remaining clip.

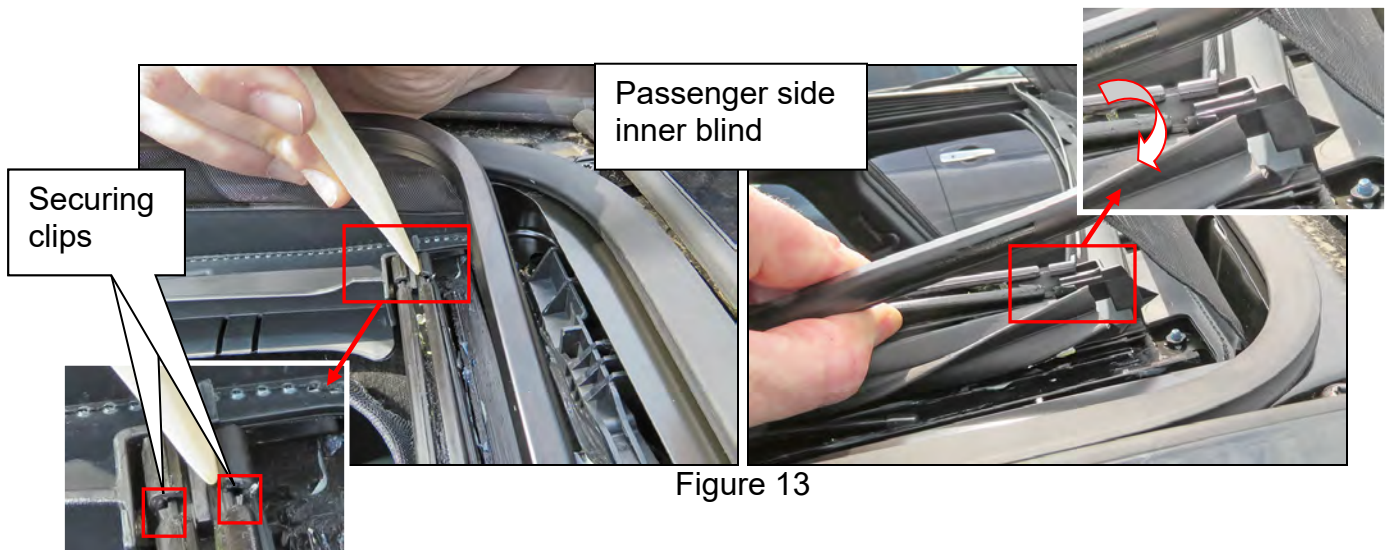

- c. Unclip the left and right inner blinds at the front corners of the “Moonroof unit assembly” (Moonroof frame) with an appropriate tool.
 - Figure 14 shows the inner blind unclipped.

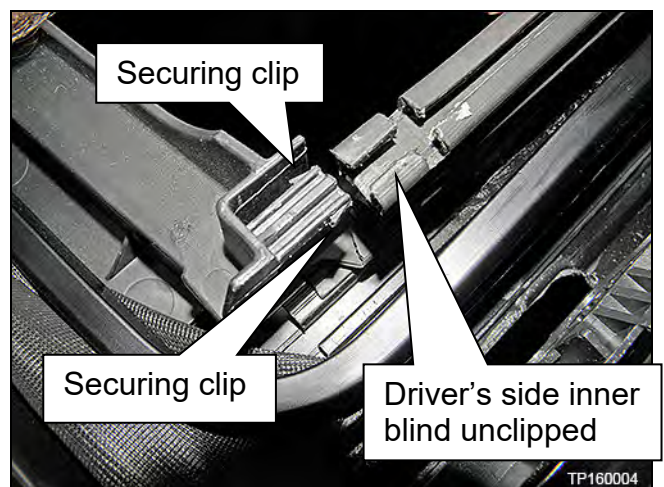

- d. Carefully detach the inner blinds from the Moonroof frame by pushing toward the inside of the vehicle along the bottom edge of inner blind (Figure 15).

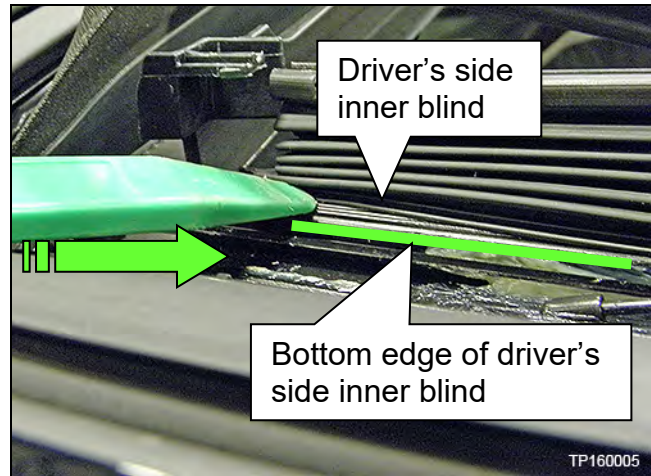

Figure 15

- e. Slide each inner blind toward the front of the vehicle and off of the Moonroof guides (Figure 16).

NOTE: Figure 16 is shown from inside the vehicle.

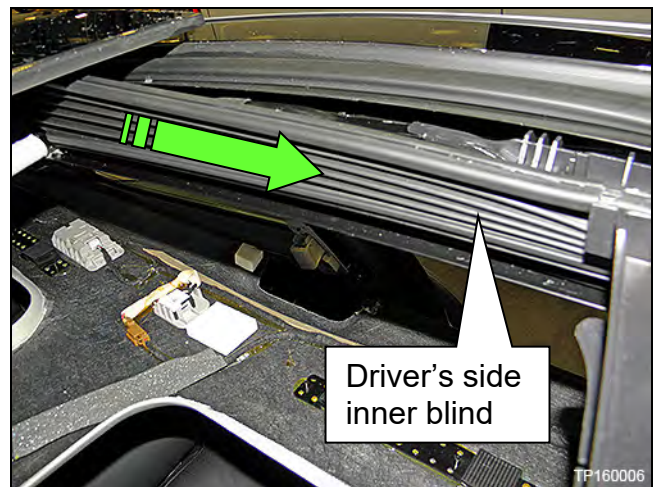

Figure 16

2. Remove the left and right “side pawl” (pivot clips) and “side arms” (wind deflector arms) from the Moonroof unit assembly (Moonroof frame) as follows:
 - a. Depress the molded tab on the pivot clip to lift it out of the notch in the Moonroof frame (Figure 18).
 - b. Slide the pivot clip and wind deflector arms toward the front of the vehicle.

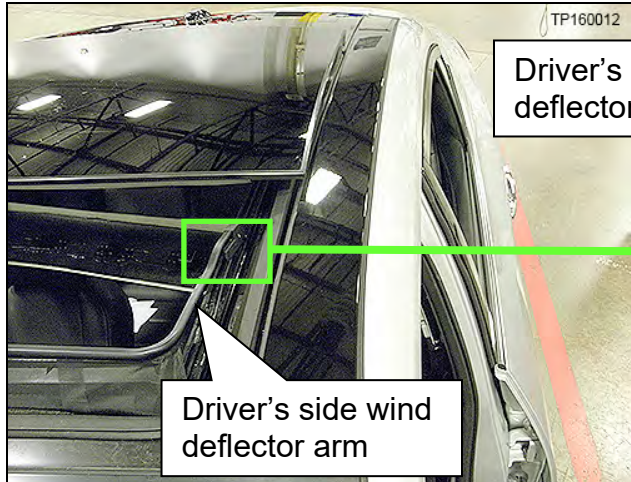

Figure 17

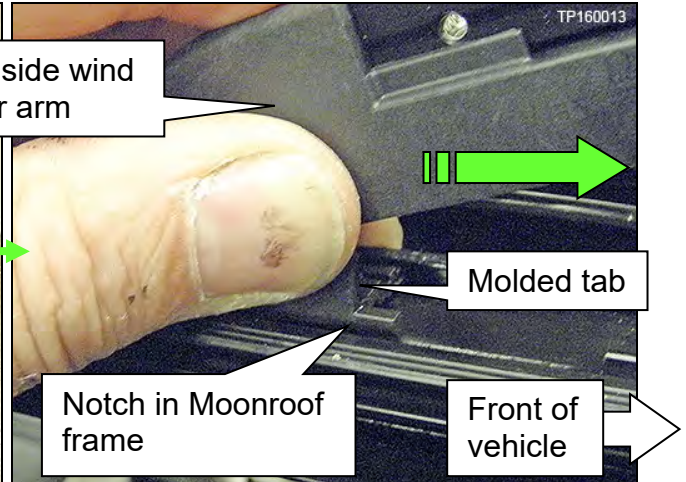

Figure 18

- Figure 19 shows a pivot clip with the wind deflector arm removed so that lifting the molded tab can be seen.

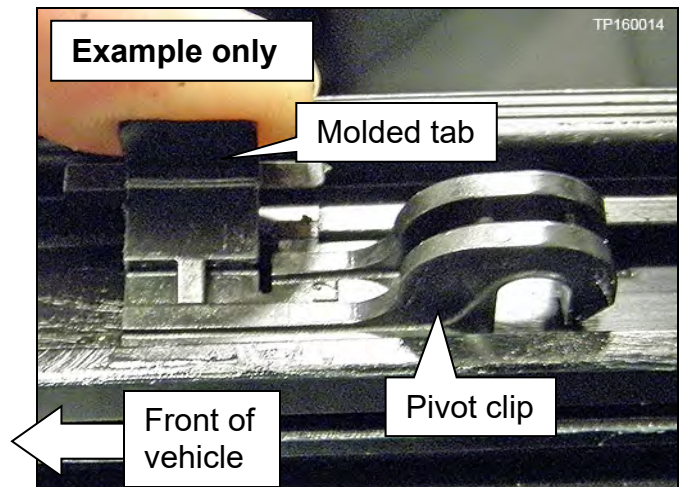

Figure 19

- c. Detach the pivot clip and wind deflector arm from the frame (Figure 20).

NOTE: The pivot clips are left and right side specific. A piece of painter's tape marked "left" or "right" may help distinguish them for reassembly.

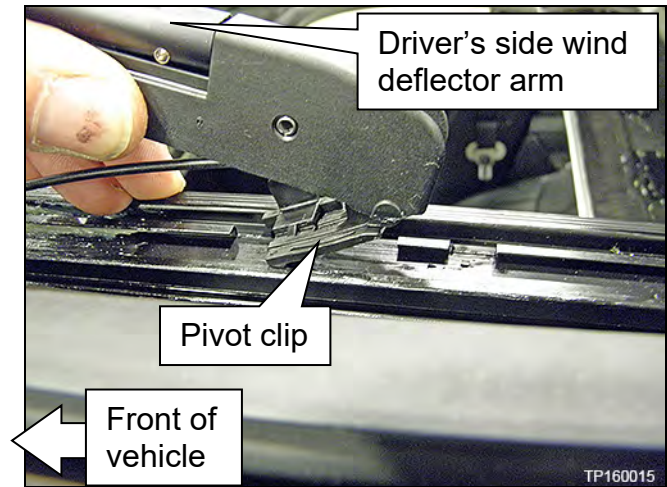

Figure 20

- 3. Detach the wind deflector assembly from the front of the Moonroof frame:
 - a. Gently lift the 3 attachment clips with a small screw driver one at a time (Figure 21).
 - b. Slide the wind deflector assembly toward the rear of the vehicle to release it from the Moonroof frame (Figure 21).

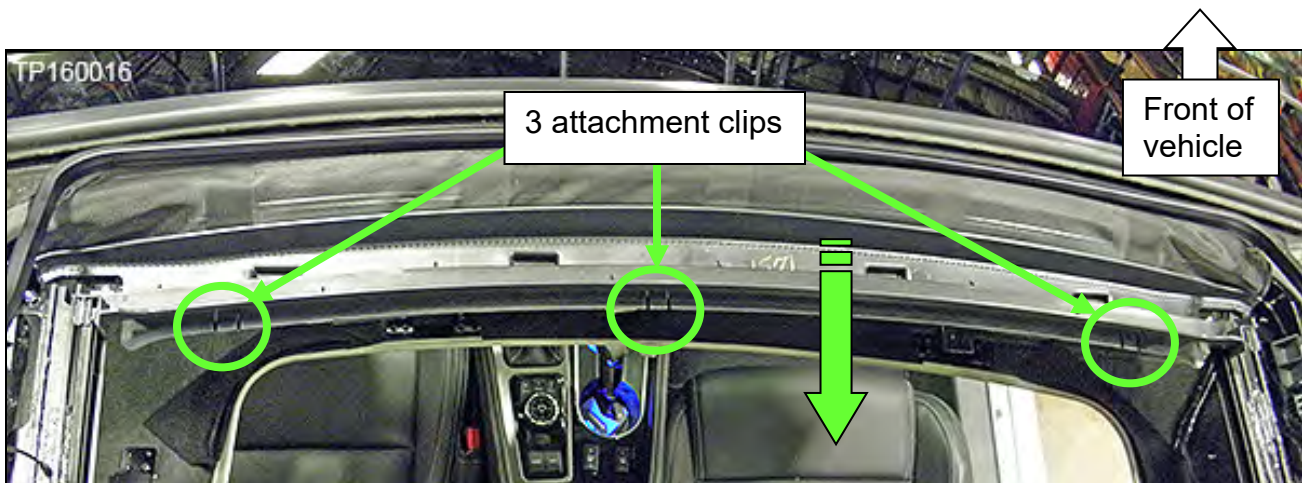

Figure 21

Installation

4. Insert the four tabs of the wind deflector into the Moonroof frame (Figure 22).

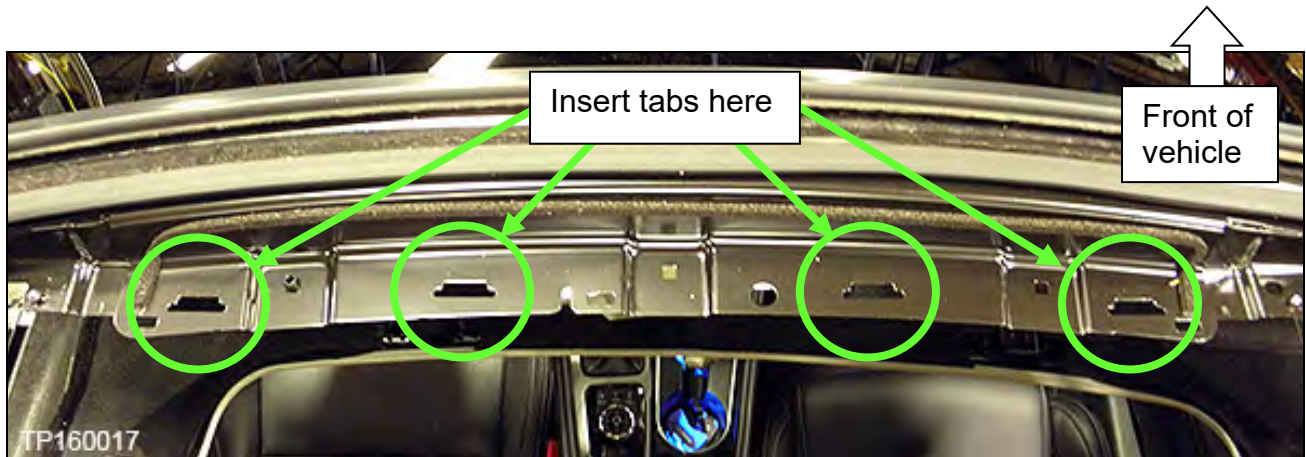

Figure 22

5. Slide the wind deflector toward the front of the vehicle and snap the 3 attachment clips (shown in Figure 21) into the Moonroof frame.

NOTE: Confirm that all three attachment clips are completely engaged.

6. Install the pivot clips onto both wind deflector arms and then proceed to install the clips, one at a time, onto the Moonroof frame.
7. Confirm that the molded tabs are completely locked into the Moonroof frame, and are flush with Moonroof frame (Figure 23).

- Figure 23 shows the driver's side pivot clip with wind deflector arm removed so that the molded tab can be seen.

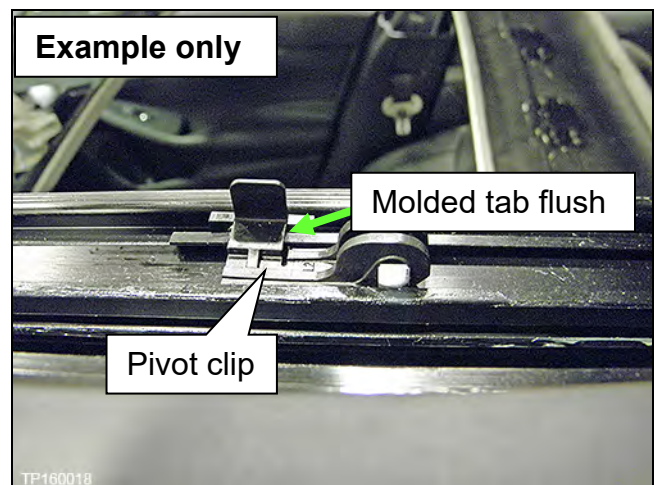

Figure 23

8. Reinstall the left and right inner blinds.

a. Slide the top of the left and right inner blinds onto their guides (Figure 24).

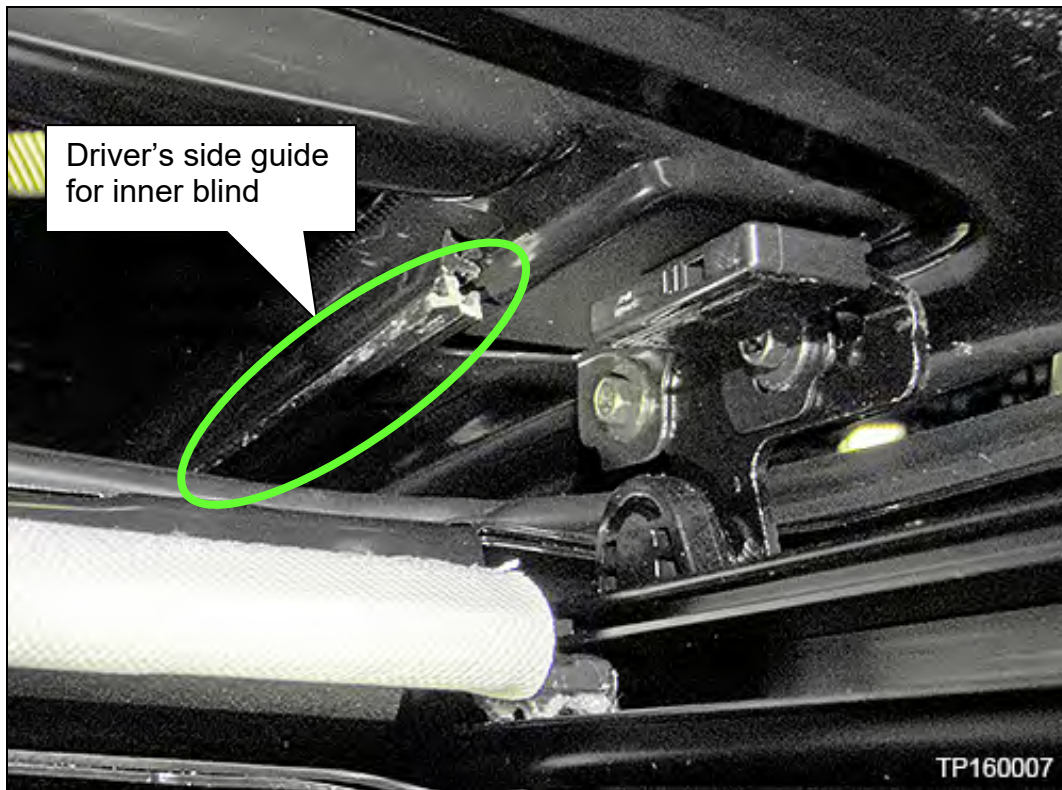

Figure 24

b. Reconnect the front clip of the inner blind to the front corner of the Moonroof frame (Figure 25).

c. Attach the bottom of the inner blinds to the Moonroof frame.

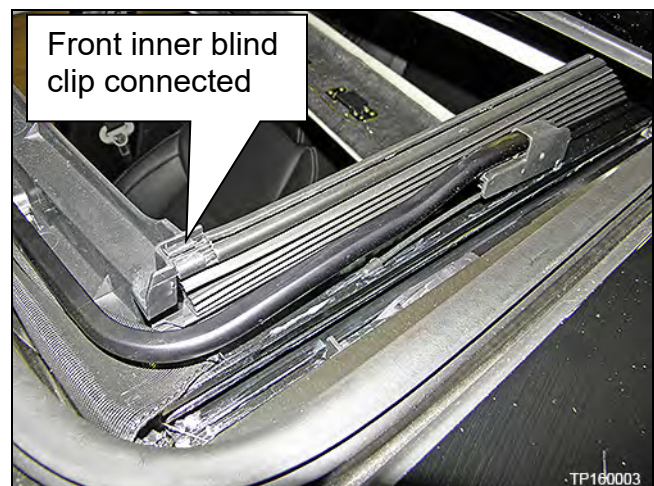

Figure 25

9. Close the Moonroof.

10. Turn the ignition OFF.

Roof Finisher Replacement

IMPORTANT: Do not lower the headlining to repair or replace roof finishers.

1. Is a roof finisher only loose (no scratches or seal issues)?

YES: Snap the roof finisher into place using even downward pressure over each clip. If the roof finisher seats completely no further repairs are required. If it will not seat proceed to step 2.

NO: Proceed to step 2 to replace roof finishers.

NOTE: This procedure applies to the left and/or right side as shown in the photos. The process is the same for either side.

2. Turn the ignition ON, but do not start the engine.
3. Open the Moonroof completely.



Figure 26

4. Remove the inboard screw (single use T25) securing the front of the affected roof finisher.

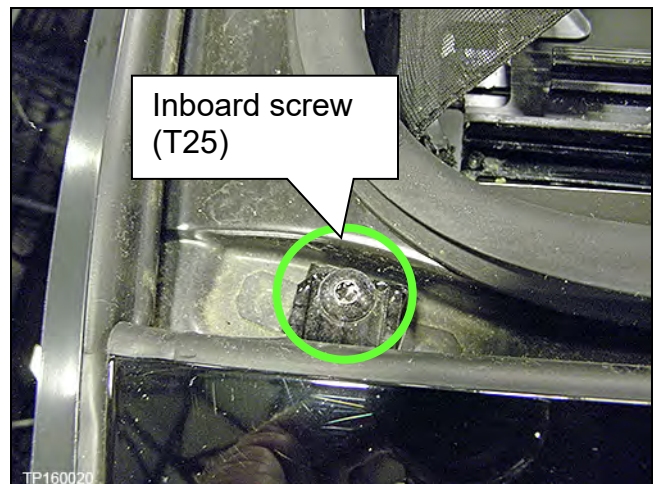

Figure 27

5. Using a finesse stick, lift the roof finisher at the front outside edge.
6. Slide the finesse stick down the length of the outside edge of the roof finisher to detach all pins.
7. Remove the roof finisher.

NOTE: Some vehicles were equipped with adhesive under the roof finishers.

- If the roof finisher released, continue to step 10 on page 16.
- If the roof finisher will not release after the pins have been detached, cut away any adhesive as described starting on the next page.



Figure 28

8. Cut adhesive from the roof finisher.

- The red dotted line indicates where the adhesive will be cut in the next step.

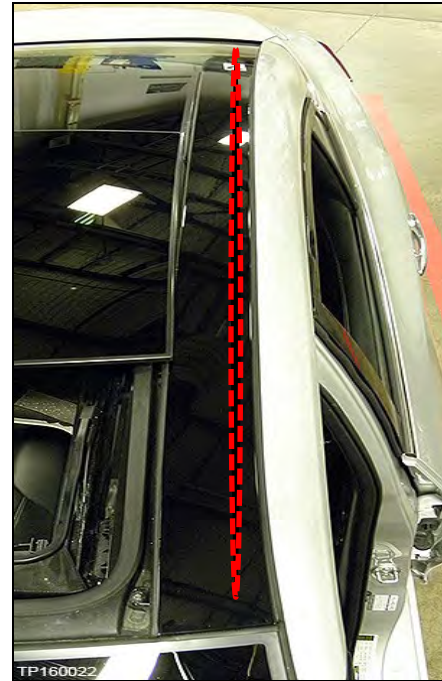

Figure 29

9. Using an adhesive cutting tool and starting at the front, cut the adhesive between the roof finisher and roof.

CAUTION: Apply tape on the roof to avoid damage to the painted surfaces.

NOTE: It may be necessary to perform this step more than once to cut through all of the adhesive.

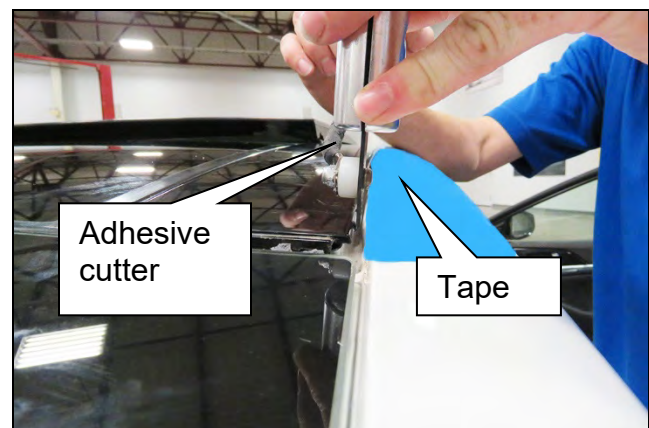

Figure 30



Figure 31

10. Using a finesse tool, lift the roof finisher at the front outside edge.

11. Slide the finesse tool down the length of the outside edge of the roof finisher to detach all pins.

12. If the roof finisher will still not release after the pins have been released, cut away any adhesive under the roof finisher indicated by the green circles as shown in Figure 32.

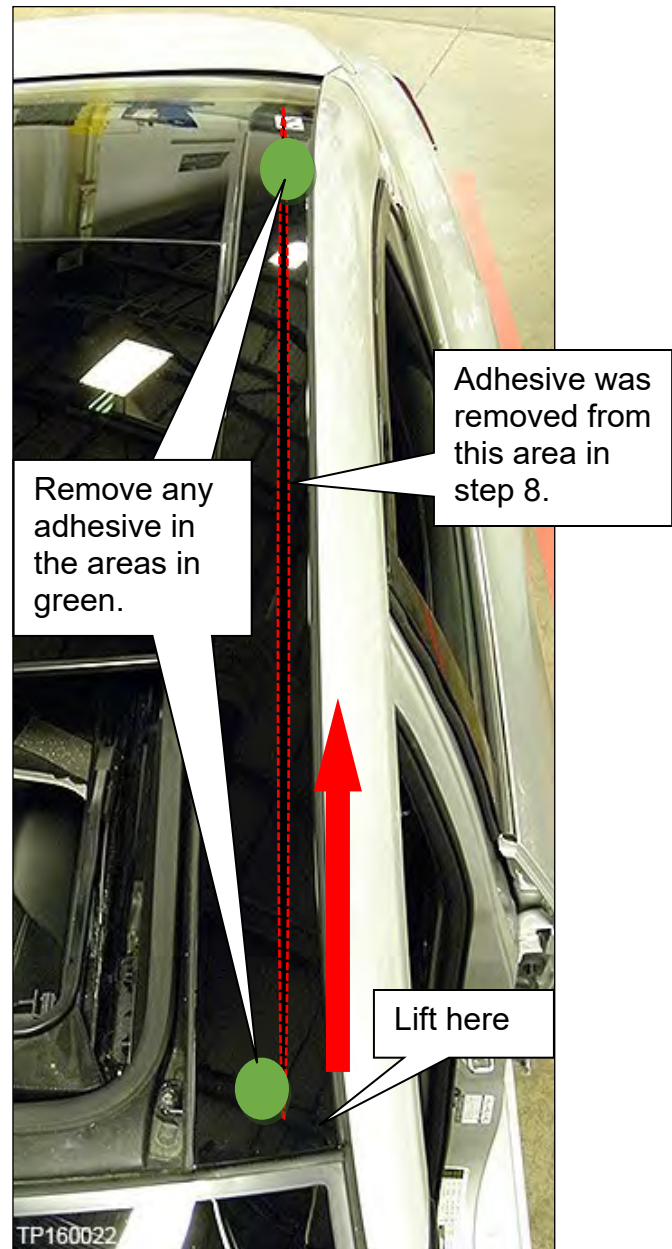

Figure 32

13. After removing the roof finisher, inspect the attachment rails on the roof that the roof finisher attaches to (total of 5 per side).

- If an attachment rail is bent, use a finesse stick to lift and straighten it.

NOTE: Figure 33 is an example of a straight attachment rail.

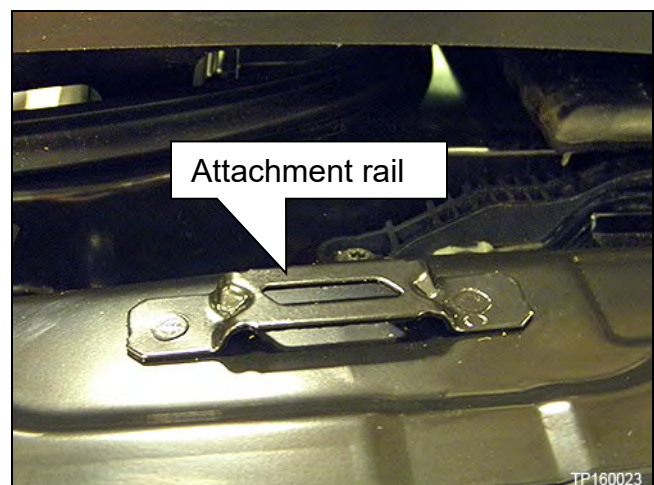

Figure 33

Installation

1. Remove the old roof finisher adhesive from the vehicle.

NOTE: Any remaining adhesive residue similar to Figure 34 is acceptable.

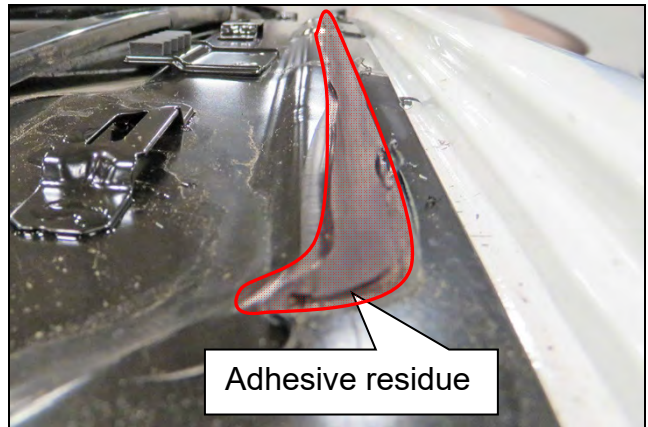

Figure 34

2. Prepare the tip of Betaseal™ 57302N Urethane Adhesive or equivalent.



Figure 35

NOTE:

- To properly install the adhesive, cut a notch in the tip similar to the one shown in Figure 36.



Figure 36

- Using a power caulk tool similar to the one shown in Figure 37 will aid in adhesive installation.



Figure 37

3. Add adhesive to the same locations as the old adhesive.

NOTE: Apply the adhesive ½ inch (13 mm) high.

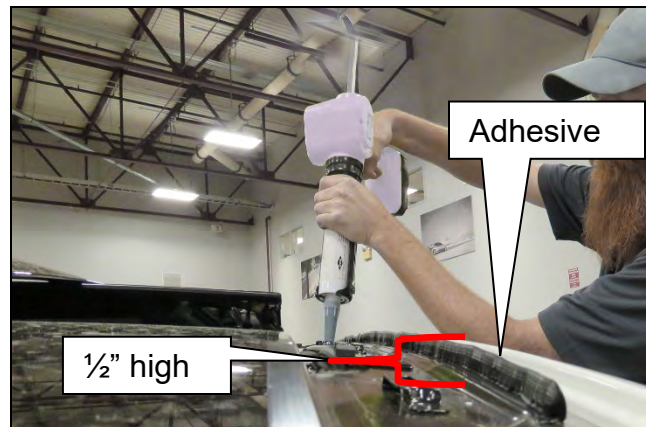

Figure 38

4. Verify the 3 roof finisher pins and 5 spacers have not become separated during roof finisher removal.

- Reinstall any pins or clips that have become separated.
- Verify the 2 rearmost pins are centered in their slot.

NOTE: The forward most pin slot has no adjustment and will fit only one way.

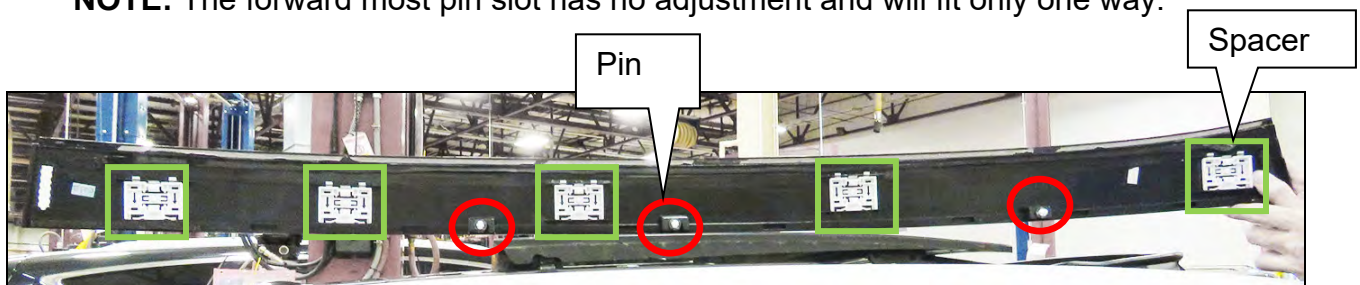

Figure 39

5. Tuck the roof finisher outer seal UNDER the windshield glass seal.

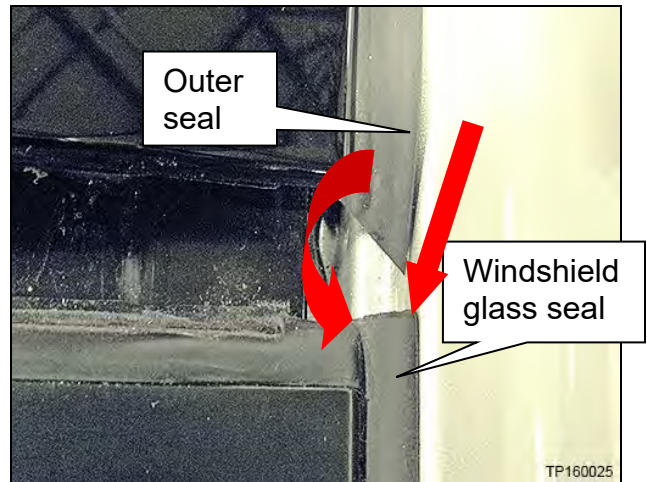

Figure 40

6. Starting from the front of the vehicle and moving rearward, attach each push pin to the roof (Figure 41).

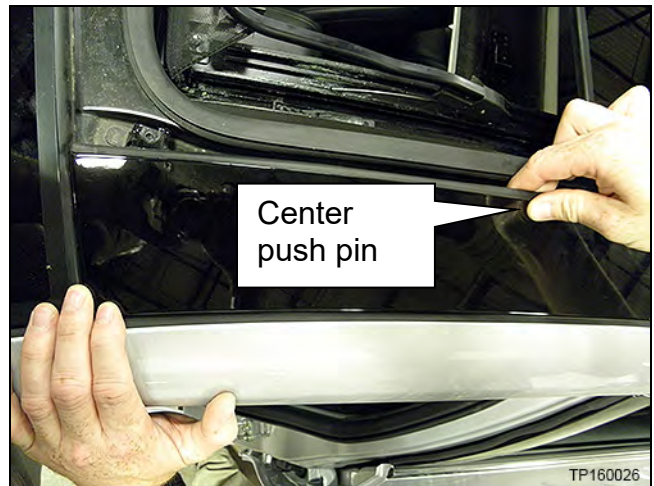

Figure 41

7. After the push pins are all attached, seat all square clips.

NOTE: Excess urethane sealant can hold the roof finisher out of position at the ends and not allow it to be seated. Trimming the extra urethane sealant will sometimes relieve the condition and allow it to seat.

8. Tuck the rear roof finisher seal under the rear window glass (Figure 42).

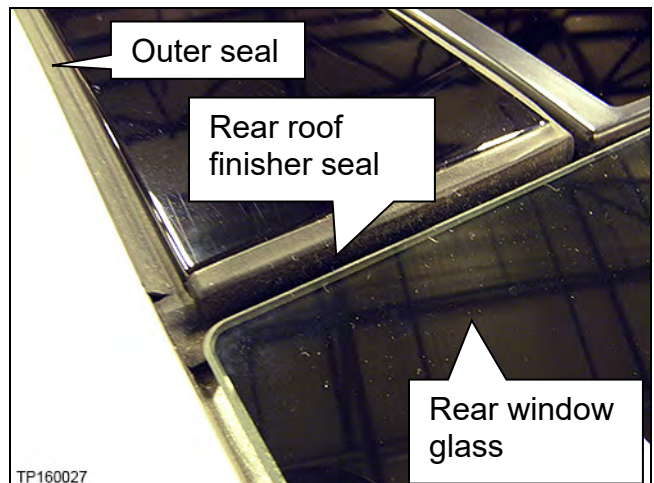

Figure 42

9. Install the new T25 inboard screw.

- Torque the screw to: 2.5 N•m (0.255 kg-m, **22 in-lb.**)

10. Close the Moonroof.

11. Turn the vehicle OFF.

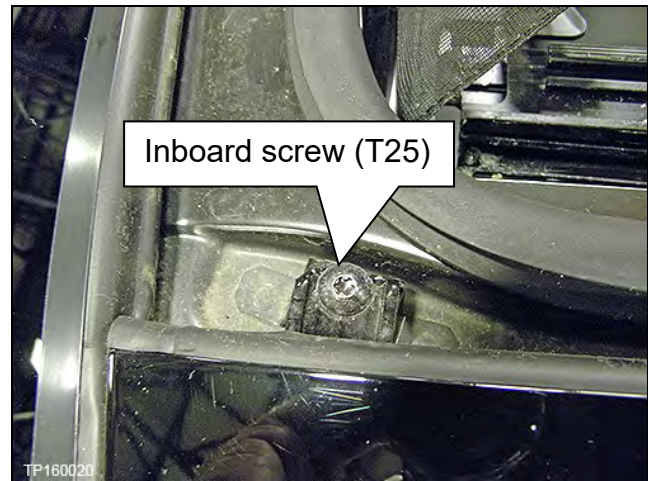

Figure 43

12. Use a finesse tool to tuck the new roof finisher seal into its channel.



Figure 44

Moonroof Glass Adjustment

If the Moonroof needs to be adjusted, loose screws tightened, or the glass is out of position, follow the steps below.

IMPORTANT: Do not lower the headlining to adjust Moonroof position.

How is the Moonroof out of adjustment?

- If there is a gap between the Moonroof and the front edge of the roof opening proceed to step 1.
- If there is a gap between the Moonroof and the front edge of the roof opening **and** also too high or low at one or more corners proceed to step 1.
- If the Moonroof is too high or low at one or more corners proceed to step 3.

1. Turn the ignition ON, but do not start engine.
2. Re-initialize the Moonroof (procedure on page 52) and recheck the gap to the front edge of the roof opening.
 - Has the gap closed after Re-initialization, and are all the corners of the Moonroof now flush with the top of the vehicle?

NO: Proceed to step 3.

YES: Repair complete. Turn ignition OFF.

3. Open the Moonroof all the way.
4. Remove the left and right inner blinds (Figure 45).
 - a. Unclip the left and right inner blinds at the front corners of the “Moonroof unit assembly” (Moonroof frame) with an appropriate tool.
 - b. Rotate the inner blind to release the remaining clip.

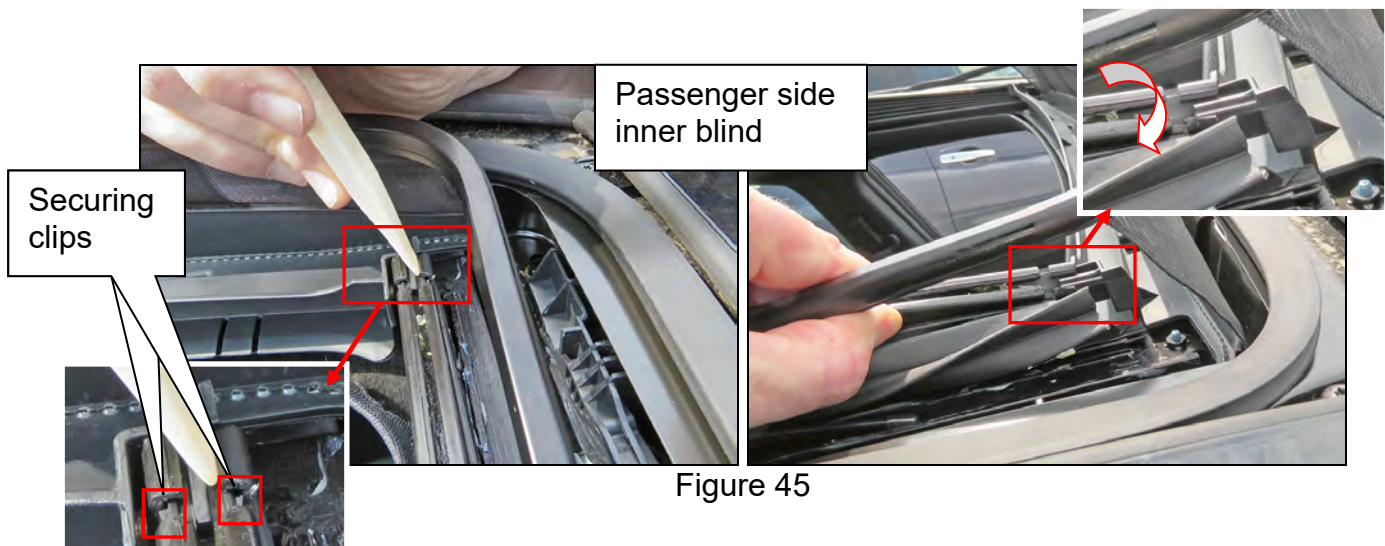

- Figure 46 shows inner blind unclipped.

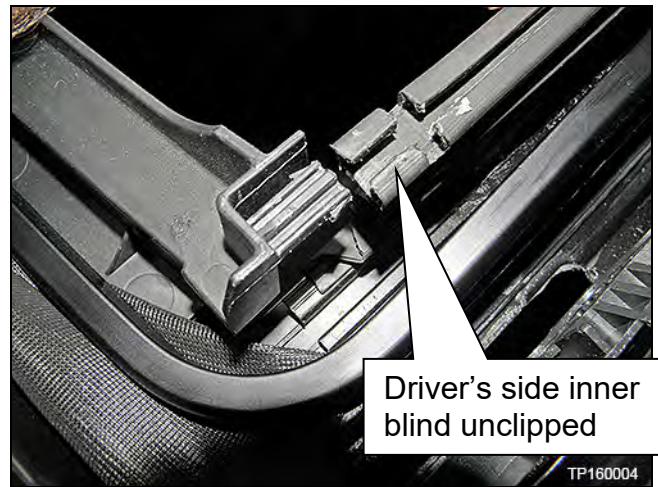

Figure 46

- c. Carefully detach the inner blinds from the Moonroof frame by pushing toward the inside of the vehicle along the bottom edge of inner blind (Figure 47).

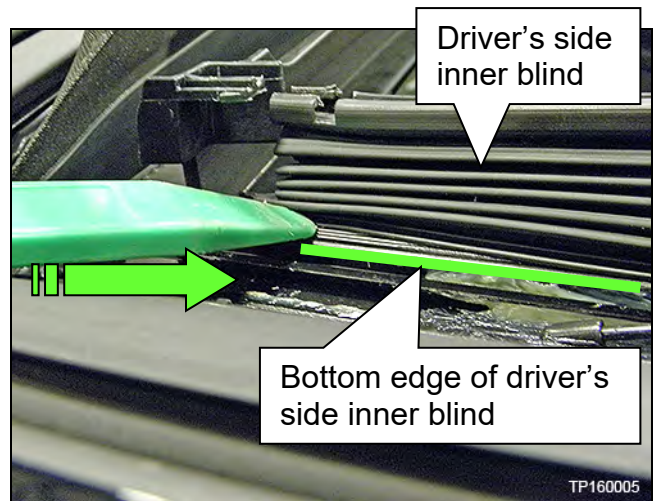

Figure 47

- d. Slide each inner blind off of the Moonroof guides (Figure 48).

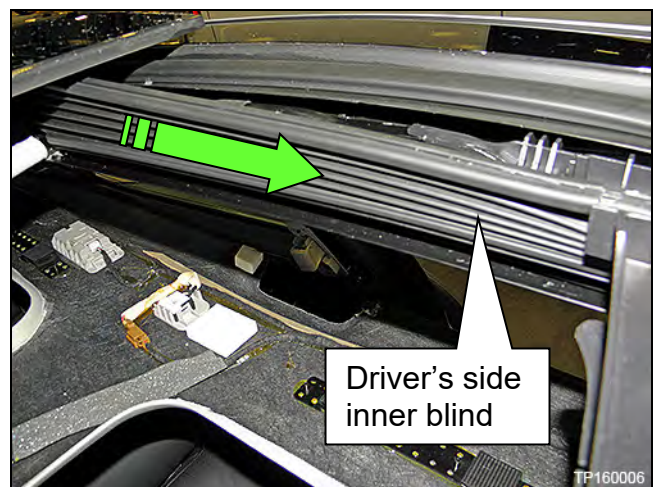

Figure 48

5. Move the Moonroof to the half way open position.
6. Remove the right and/or left knocks (Figure 49).
 - a. Lift the knock lock clip with a finesse tool vertically away from the Moonroof guide.
 - b. Slide the knock toward this inside of the vehicle.

NOTE: Only remove the knock necessary for the required adjustment.

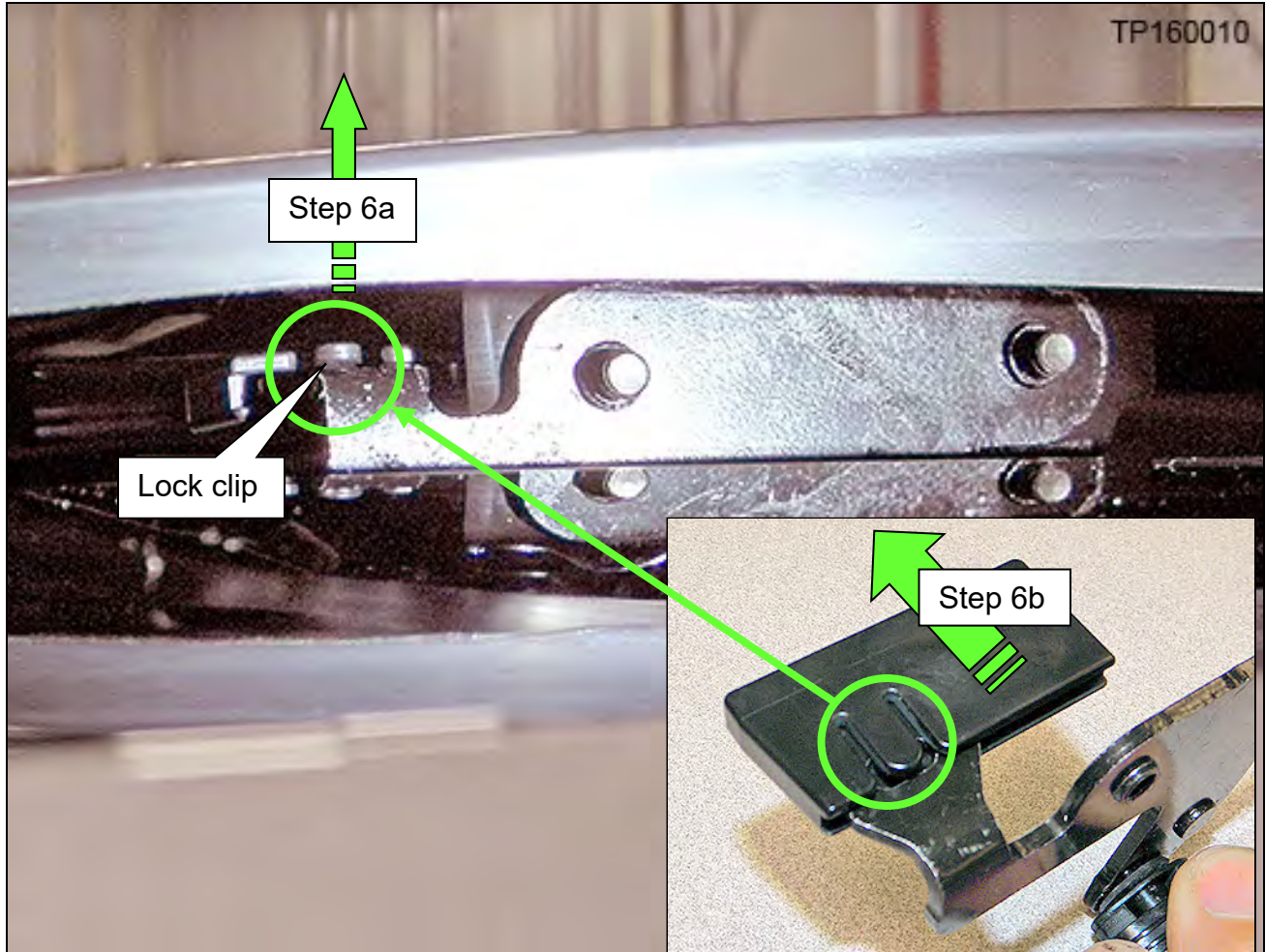

Figure 49

NOTE: Knocks are marked left (L) and right (R). Figure 50 shows a knock for the passenger side and is marked “R”.

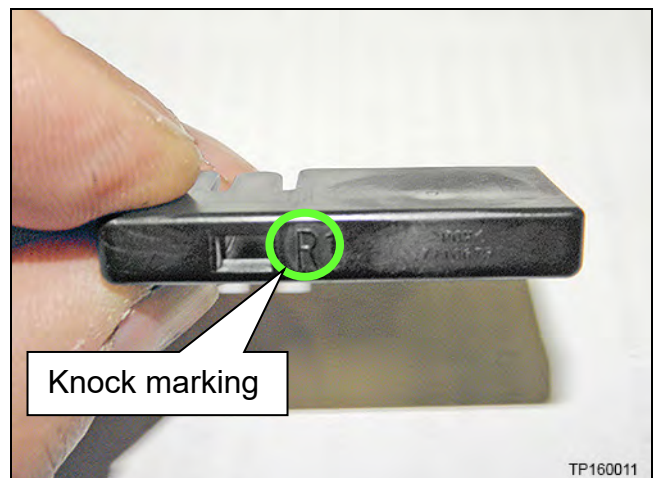

Figure 50

7. Remove left rear and/or right rear Moonroof bolt finishers (Figure 51).

NOTE: Only remove the rear bolt finisher necessary for the required adjustment.

- a. Move the Moonroof to the tilt position.

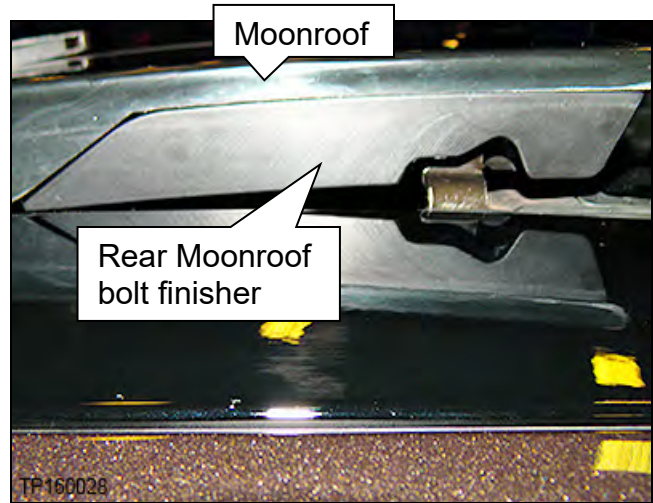

Figure 51

- b. Pull the "Moonroof bolt finisher tab" (plastic tab) down and away from the Moonroof and allow it to rest in the position shown in Figure 52.

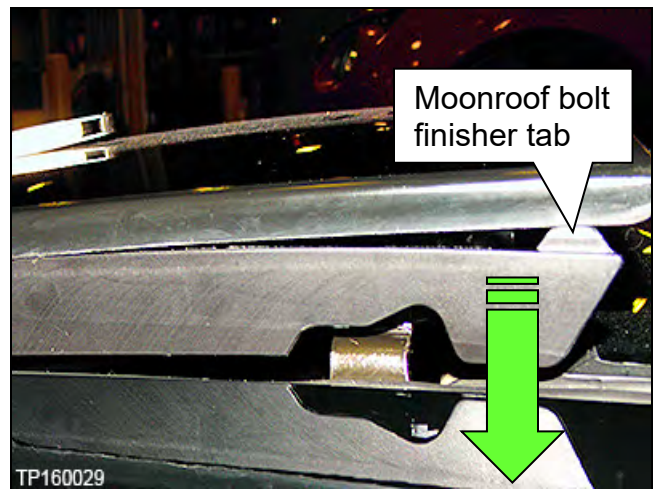

Figure 52

- c. Insert a pocket screwdriver between the Moonroof bolt finisher and the Moonroof near the plastic tab (Figure 53).

- d. Apply a slight downward force to the plastic tab end of the Moonroof bolt finisher until the hole through the steel tab can be seen (Figure 53).

- e. Slide the pocket screwdriver from the plastic tab up to the hole in the steel tab that the Moonroof release clip is connected to (Figure 53).

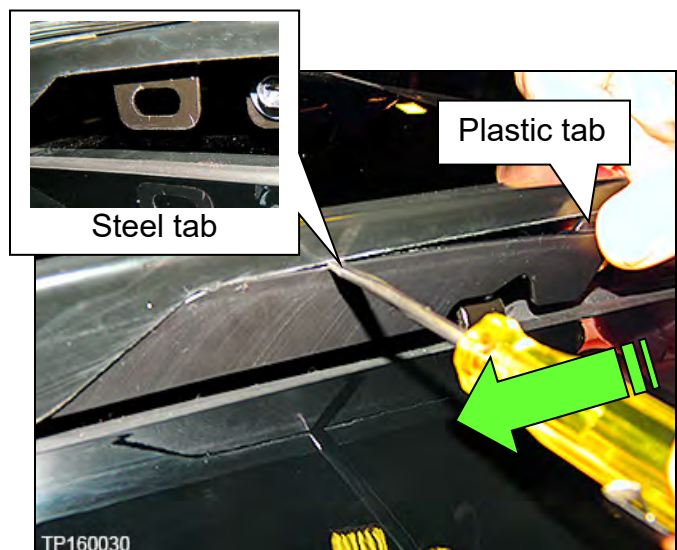

Figure 53

- f. Insert the pocket screw driver through the hole in the steel tab to release the retaining clip (Figure 54).

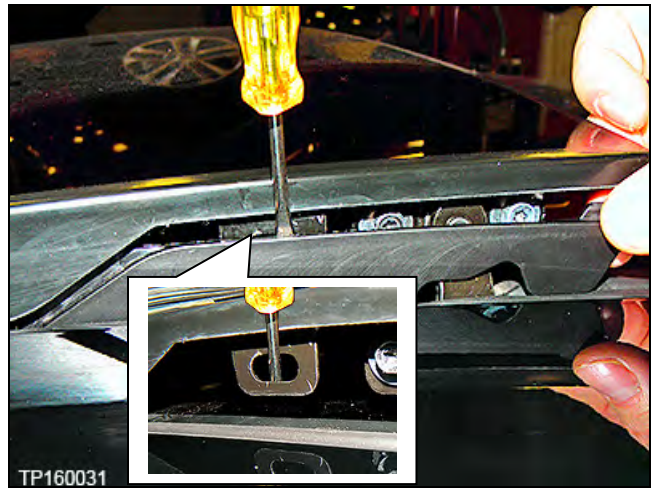

Figure 54

- Figure 55 shows how retaining clip is released.

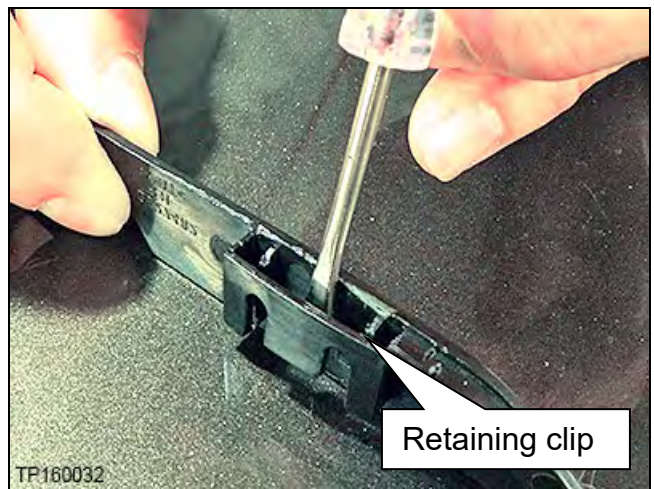

Figure 55

- g. Push Moonroof bolt finisher down and remove from vehicle (Figure 56).

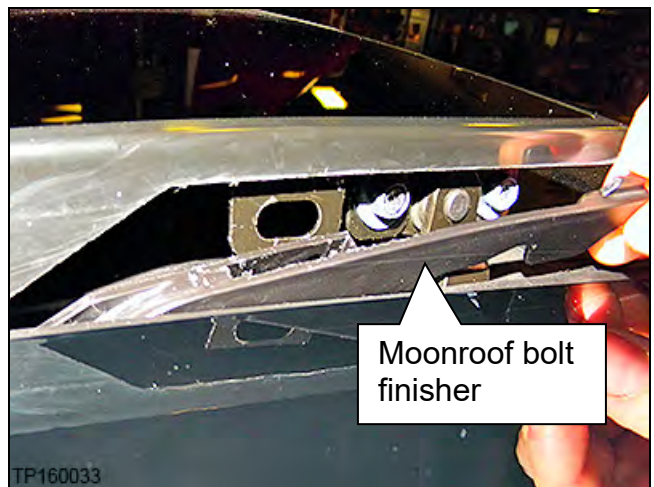

Figure 56

8. Loosen the Moonroof adjustment bolts (Figure 57 for front and Figure 58 for rear) and adjust the glass height to the proper position or height.

- Refer to **Moonroof Adjustment Clearances** at the bottom of this page.

NOTE:

- Moonroof adjustment bolts should be slightly snug, but not tight, to allow adjustments.
- Work one corner at a time to raise and lower individual corners.
- If the Moonroof needs to be moved fore/aft, loosen all adjustment bolts to adjust.

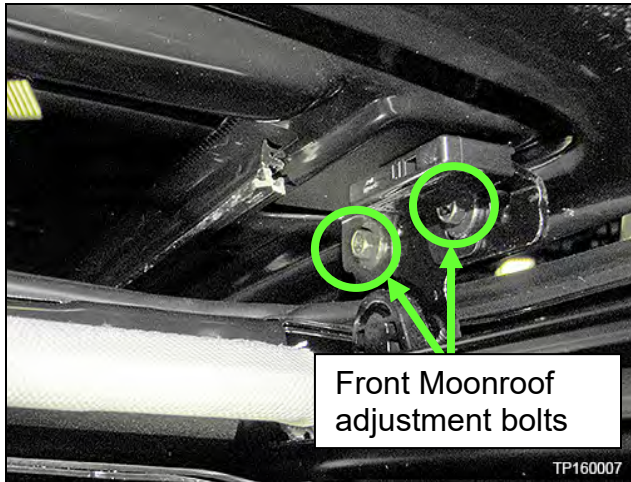

Figure 57

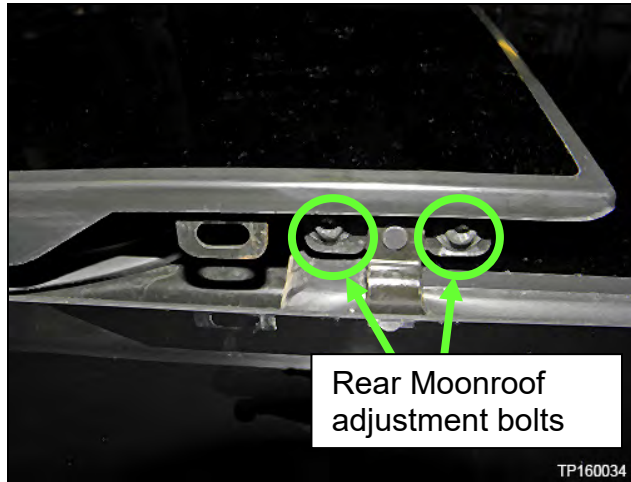
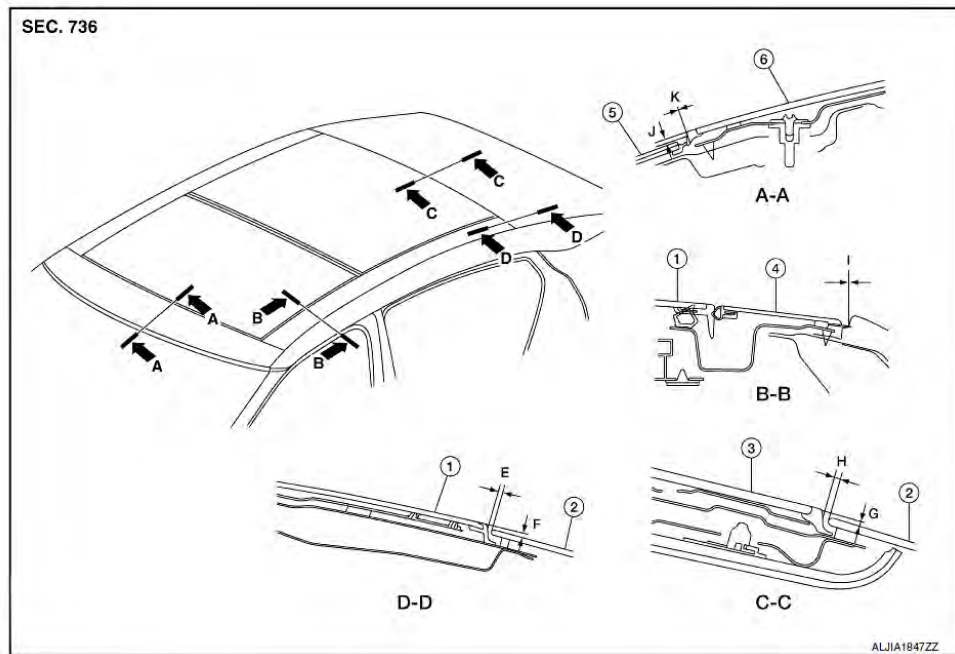

Figure 58

Moonroof Adjustment Clearances



Unit: mm (in)

- | | | |
|--------------------------------------|--------------------------------------|--|
| 1. Glass lid | 2. Rear window glass | 3. Rear moonroof glass |
| 4. Roof side finisher | 5. Windshield | 6. Front moonroof glass |
| E. 3.0 ± 2.2 (0.118 \pm 0.087) | F. 2.7 ± 2.0 (0.106 \pm 0.079) | G. $2.0 + 2.2 - 1.7$ (0.079 + 0.087 - 0.067) |
| H. 3.0 ± 2.1 (0.118 \pm 0.083) | I. 0.0 (No clearance) | J. 4.5 ± 2.0 (0.177 \pm 0.079) |
| K. 0.0 (No clearance) | | |

9. Tighten loosened adjustment bolts.

- Torque bolts to: 5.5 N•m (0.56 kg-m, **48.68 in-lb.**)

IMPORTANT:

- Make sure that the rear guides the Moonroof attaches to are level.
- Figure 59 is shown with screws removed to overemphasize incorrect pivot angle.

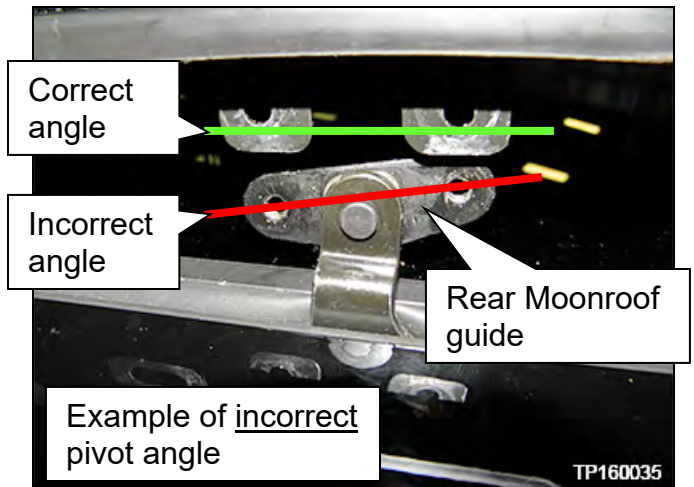

Figure 59

10. Close the Moonroof and check the adjustment.

11. Perform steps 8 through 10 until the correct Moonroof adjustment is achieved.

12. Move the Moonroof to the half-way open position.

13. Reinstall the removed knocks and rear Moonroof screw finishers.

- Pull on the knock to confirm that it is completely seated on the Moonroof guide.
- See Figure 60 for an example of correctly installed knock.

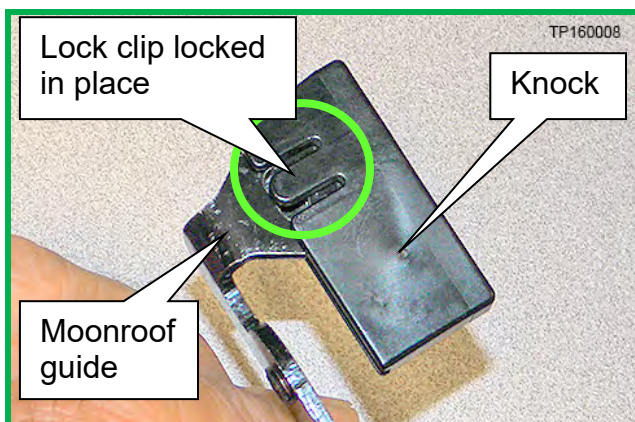

Figure 60



Figure 61

Figures 60 and 61 shown with Moonroof guide unbolted from Moonroof frame for clarity.

14. Reinstall the left and right inner blinds.

- a. Slide the top of the left and right inner blinds onto their guides (Figure 62).

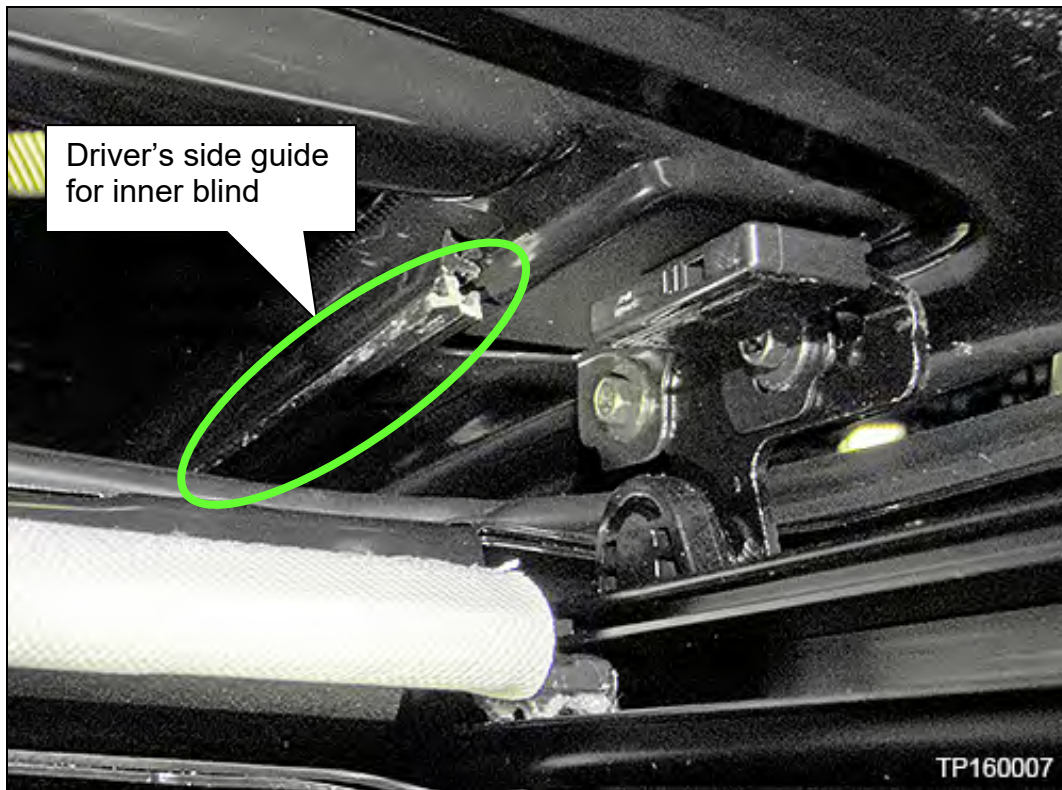

Figure 62

- b. Reconnect the front clip of the inner blind to the front corner of the Moonroof frame (Figure 63).
- c. Attach the bottom of the inner blinds to the Moonroof frame.

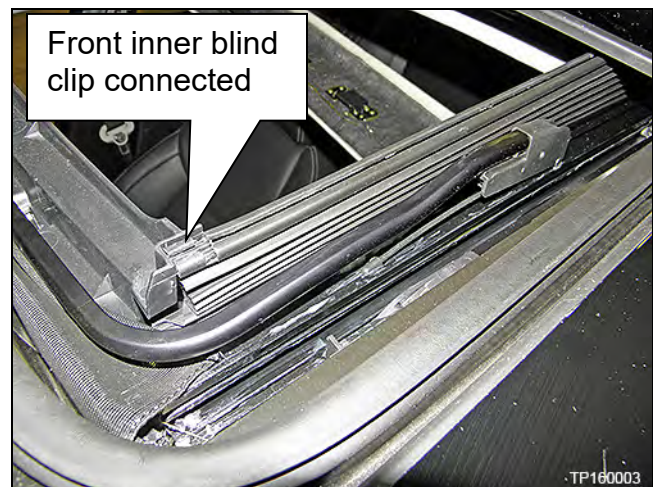

Figure 63

15. Initialization the Moonroof (procedure on page 52).

16. Close the Moonroof.

17. Turn the ignition OFF.

Front or Rear Sunshade Replacement

If the sunshade needs to be replaced due to discoloration, being jammed, out of track, loss of tension or popping/clicking while in motion, follow the steps below.

1. Inspect the “Moonroof unit assembly” (Moonroof frame) track and rails for dents, dings and gouges that might have caused the issue.
 - If the Moonroof track or rails are damaged, perform the sunshade **Removal** procedure starting from step 2 (below), replace the Moonroof frame and then perform sunshade **Installation** procedure on page 32.

NOTE: Refer to the Electronic Service Manual (ESM), section **RF – Roof** to remove and install Moonroof frame.

- If no damage is found proceed to step 2.

Removal

2. Lower (**DO NOT REMOVE**) the headlining and let it rest on the seat head rests.
 - Refer to the Electronic Service Manual (ESM), section **RF – Roof** to remove and install headlining.

IMPORTANT:

- Do not remove the front or rear windshield from the vehicle.
- Do not remove the headlining from inside the vehicle.

NOTE: The following Figures may be of either the driver or passenger side. Both sides are similar.

3. Remove two bolts per side air bag (4 total) that attach the left and right side airbags to the roof rail and then allow them to hang free (Figure 64).

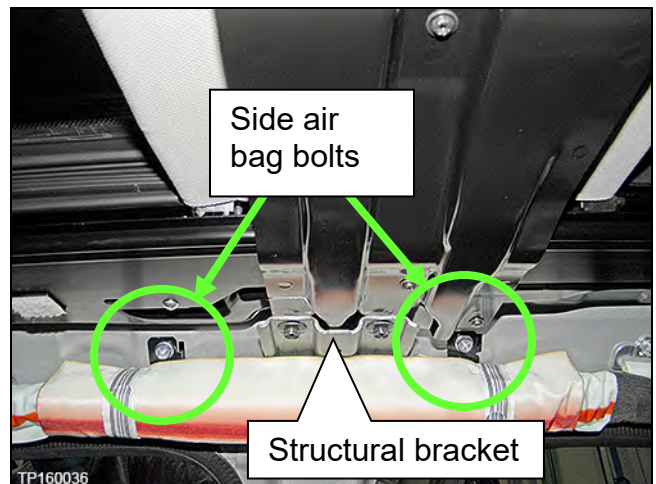

Figure 64

4. Remove the left and right structural brackets (Figure 65) attached to the center reinforcement support (4 bolts each; highlighted in Figure 65).

NOTE: It is not necessary to remove the harness from the driver's side bracket (Figure 65).

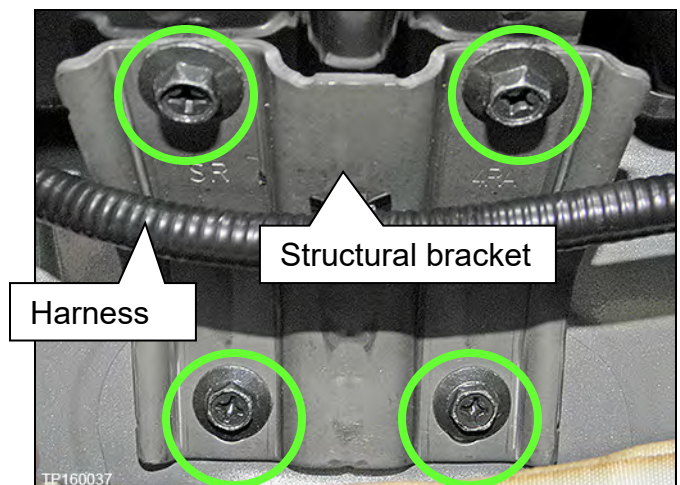

Figure 65

5. Remove the center reinforcement support (Figure 66) held by 9 T20 bolts.

- Center reinforcement support shown outside vehicle for clarity.

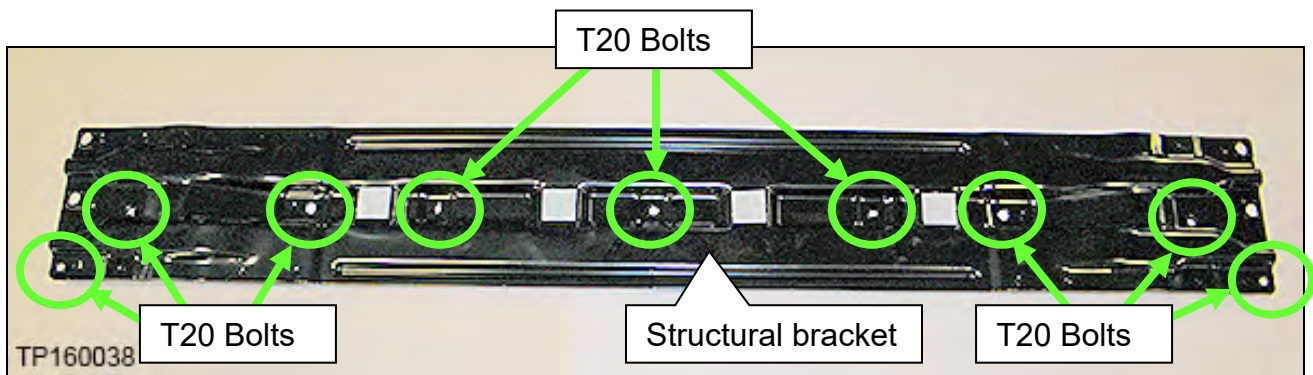

Figure 66

IMPORTANT: In the following steps only remove the sunshade requiring replacement.

- The following steps can be used for front or rear sunshades.
- The front bar of the Maxima sunshade is curved to match the front opening. The rear sunshade has a straight bar.

6. Turn the ignition ON, but do not start engine.

7. Partially open the affected sunshade to gain access to the sunshade's coupler release tab.

- Figure 67 and Figure 68 show the right side of the front sunshade.

8. Detach the sunshade from the sunshade coupler by pressing the coupler release tab (Figure 68).

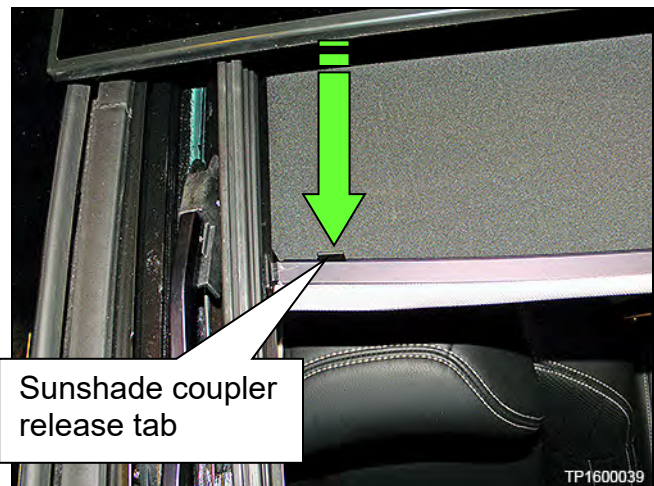

Figure 67

- Figure 68 shows sunshade coupler detached.

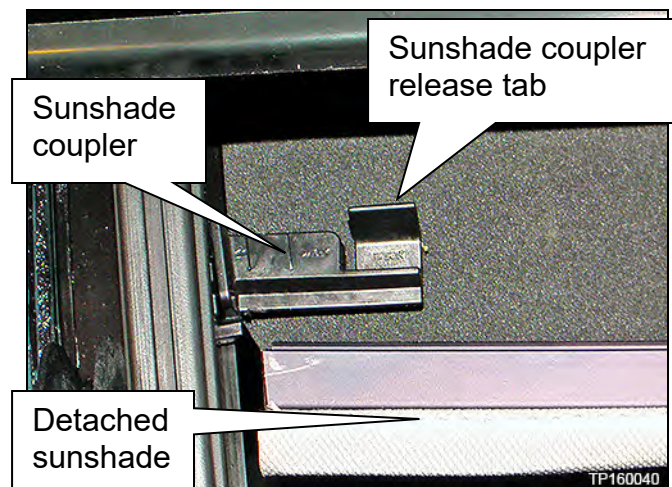

Figure 68

9. Detach the affected (front and/or rear) sunshade from the Moonroof frame.

NOTE: Only remove the sunshade that is to be replaced.

Rear shade:

- a. Detach the rear sunshade by pulling it toward the right of the vehicle to compress tension spring (Figure 69).
- b. While compressing the tension spring on right side, tilt left side down to clear pivot.
- c. Slowly release compression pressure, but do not remove the sunshade from the right side pivot in Moonroof frame.
- d. Ratchet the sunshade gently in the retract direction (rolled up) until the ratchet holds the coil spring tension.
- e. Remove the sunshade from the vehicle.
- f. Install the pull pin (Figure 71) into sunshade (a paper clip will also work).

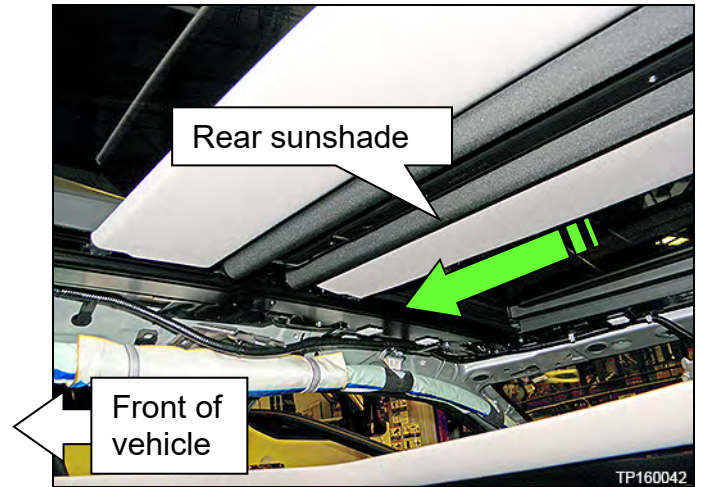

Figure 69

Front shade:

- a. Detach the front sunshade by pulling it toward the left of the vehicle to compress tension spring (Figure 70).
- b. While compressing the tension spring on left side, tilt right side down to clear pivot.
- c. Slowly release compression pressure, but do not remove the sunshade from the left side pivot in Moonroof frame.
- d. Ratchet the sunshade gently in the retract direction (rolled up) until the ratchet holds the coil spring tension.
- e. Remove the sunshade from the vehicle.
- f. Install the pull pin (Figure 71) into sunshade (a paper clip will also work).

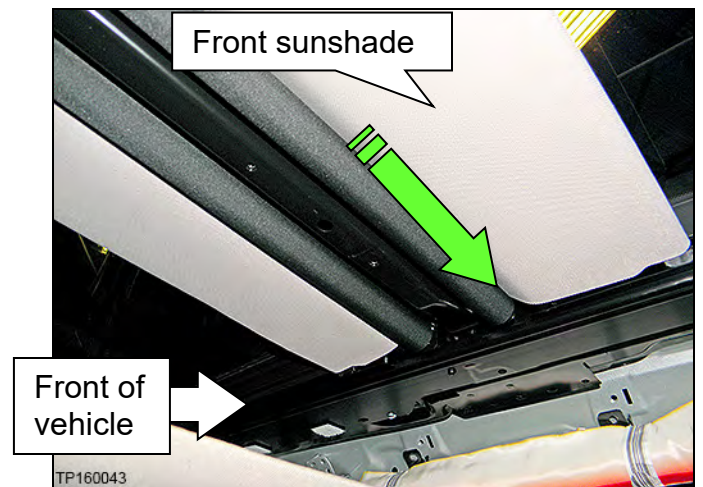

Figure 70

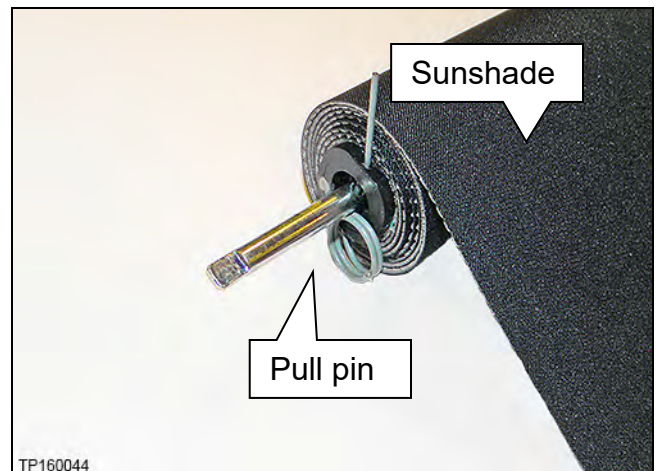

Figure 71

Sunshade Installation

10. Reinstall the front and/or the rear sunshades.

Rear shade:

- a. Gently remove the pull pin from the rear sunshade.
- b. While securely holding the rear sunshade, push it into the passenger side pivot mount in the Moonroof frame.
- c. While still preventing the rear sunshade from rotating, tilt it up on the driver side and install it into the Moonroof frame.
- d. Continuing to prevent the rear sunshade from rotating, partially open the sunshade and connect to couplers.

Front shade:

- a. Gently remove the pull pin from the front sunshade.
- b. While securely holding the front sunshade, push it into the driver side pivot mount in the Moonroof frame.
- c. While still preventing the front sunshade from rotating, tilt it up on the passenger side and install it into the Moonroof frame.
- d. Continuing to prevent the front sunshade from rotating, partially open the sunshade and connect to couplers.

11. Reinstall the steel center reinforcement (9 T20 bolts).

- Torque bolts to: 3 N•m (0.30 kg-m, **26.55 in-lb.**)

12. Reinstall the left and right structural brackets attached to the center reinforcement support (4 bolts each).

13. Reinstall the left and right side airbags to the roof rail.

- Torque bolts to: 10.5 N•m (1.1 kg-m, **8 ft-lb**)

14. Using the Moonroof switch, check the function of both sunshades before reinstalling the headlining.

15. Re-initialize the sunshades (procedure on page 52).

16. Reinstall the headlining.

17. Turn the ignition OFF.

Moonroof or Sunshade Motor and Drive Cable Replacement

If the Moonroof or Sunshade motors are inoperative or noisy, follow the steps below.

1. Turn the ignition ON, but do not start engine.
2. Re-initialize the affected drive motor (Moonroof or sunshade) with the procedure on page 52.

NOTE: You might have to bump the Moonroof or sunshade to the closed position using the switch on the headlining before initialization.

- If the motor will not function, check all electrical connections. Refer to the Electronic Service Manual (ESM), section **RF – Roof** for further information.

3. Does the Moonroof or sunshade now operate correctly?

YES: Repair complete. Turn ignition OFF.

NO: Proceed to step 4.

4. Drop the headlining and let it rest on the seat head rests.

- Refer to the Electronic Service Manual (ESM), section **RF – Roof** to remove and install headlining.

IMPORTANT:

- Do not remove the front or rear windshield from the vehicle.
- Do not remove the headlining from inside the vehicle.

5. Inspect the drive cables in the rear of the Moonroof frame. Have the cables come out of the track?

NO: Continue to step 6 on the next page.

YES: Skip to step 12 on page 35.

6. Loosen the two mounting bolts of the affected drive motor.
 - Figure 72 shows the sunshade drive motor bolts (T25). The Moonroof drive motor bolts are similar.

NOTE: For reference, the sunshade motor is furthest forward on the Moonroof frame.
7. Lower the affected drive motor to relieve drive cable tension, and then reinstall drive motor.
 - Torque bolts to: 3 N•m (0.30 kg-m, **26.55 in-lb.**)
8. Re-initialize the affected drive motor (procedure on page 52).

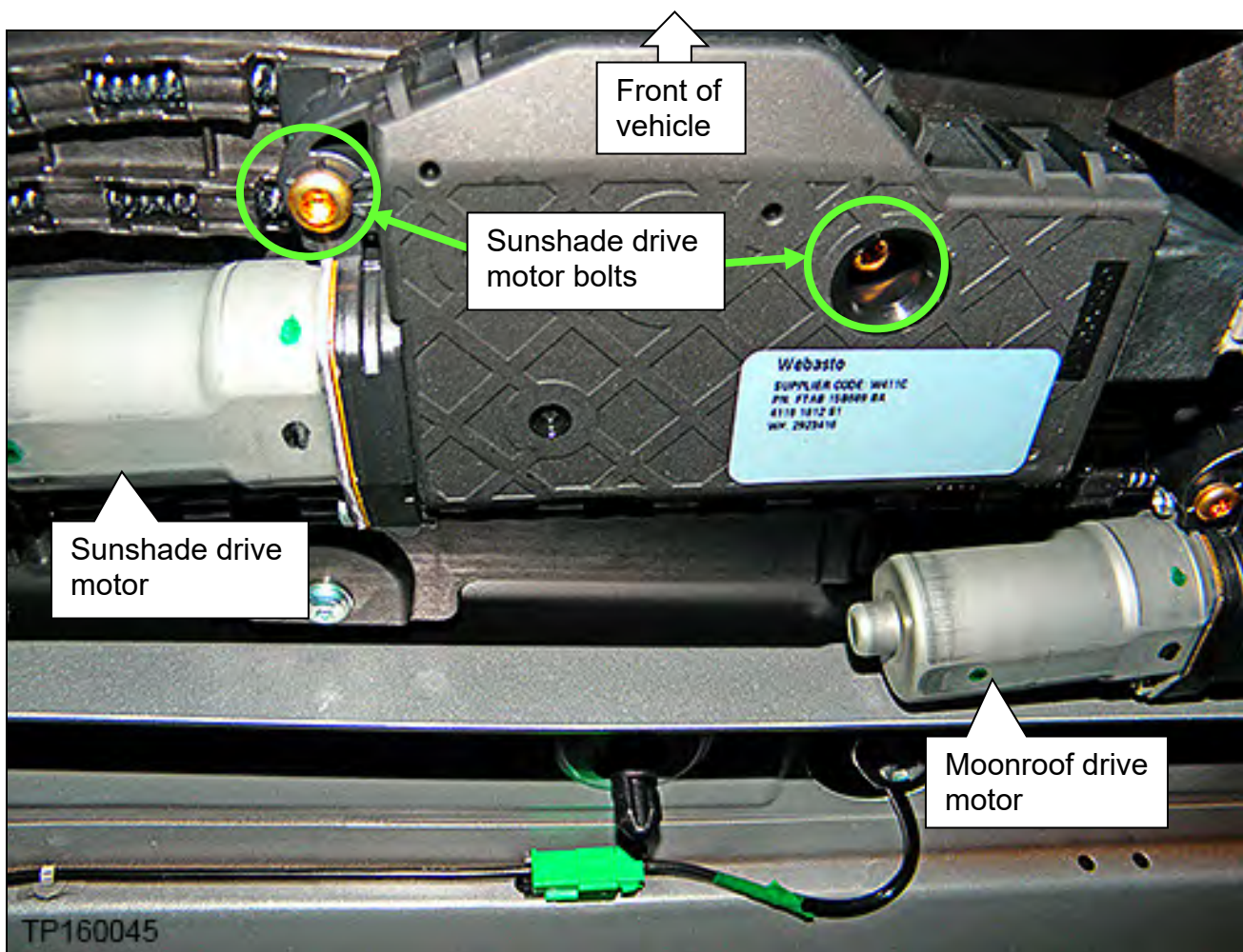

Figure 72

9. Re-check the Moonroof or sunshade function using the front headlining switch. Does the Moonroof or sunshade now operate correctly?

YES: Repair complete. Turn the ignition OFF.

NO: Proceed to step 10.

10. Replace only the affected drive motor.

- Torque bolts to: 3 N•m (0.30 kg-m, **26.55 in-lb.**)

11. Re-initialize the affected drive motor (procedure on page 52). Does the Moonroof or sunshade now operate correctly?

YES: Repair complete. Turn ignition OFF.

NO: Proceed to step 12.

12. Replace the Moonroof frame assembly.

- Refer to the ESM, section **RF – Roof** for removal and installation.

13. Transfer the Moonroof and sunshade motors from the old to the new Moonroof frame.

- Torque bolts to: 3 N•m (0.30 kg-m, **26.55 in-lb.**)

14. Perform Initialization of the Moonroof **and** sunshade (procedure on page 52).

13. Reinstall the headliner.

15. Turn the ignition OFF.

Rear Link Replacement

NOTE: This procedure applies to the left and right side of the vehicle. The right side is shown in the photos, but the process is the same for the left side.

You will be inspecting and possibly replacing the rear link with anti-rattle clip assembly. See Figure 73 and 74 below to become familiar with these components.

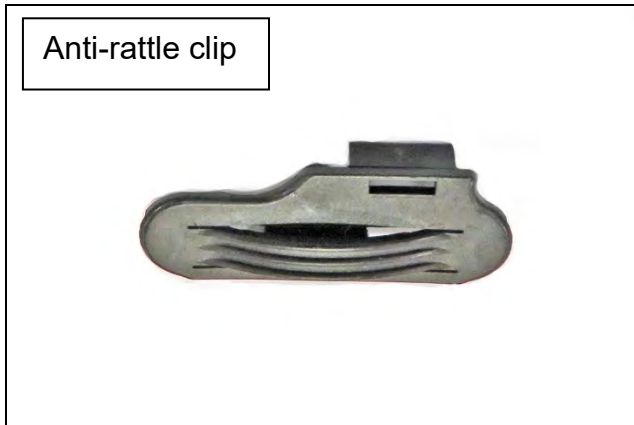

Figure 73

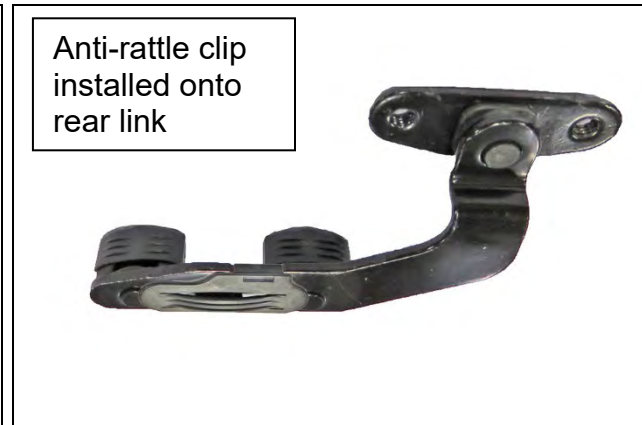

Figure 74

1. Inspect for a broken anti-rattle clip.
 - a. Use a finesse tool to lift the roof finisher seal to access the Moonroof rail.

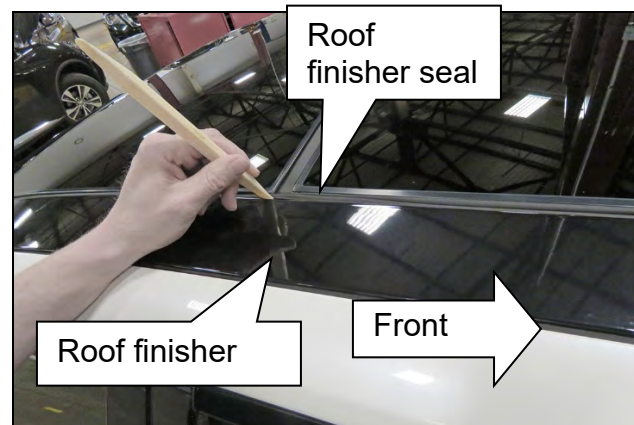

Figure 75

2. Inspect the Moonroof rail area outlined in red for pieces of the anti-rattle clip.

- Repeat steps 1 and 2 on the other side of the Moonroof.
- If pieces are found, continue to step 3 on the next page.

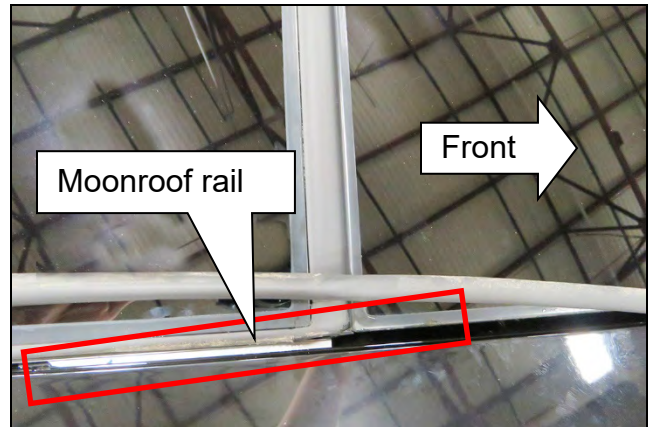

Figure 76

- If no pieces are found, operate the Moonroof to the tilt position and inspect the anti-rattle clip installation on the rear link.
- Refer to Figure 77 for an example of a GOOD anti-rattle clip.
- If any part outlined in red is missing or damaged, continue to step 3 on the next page.

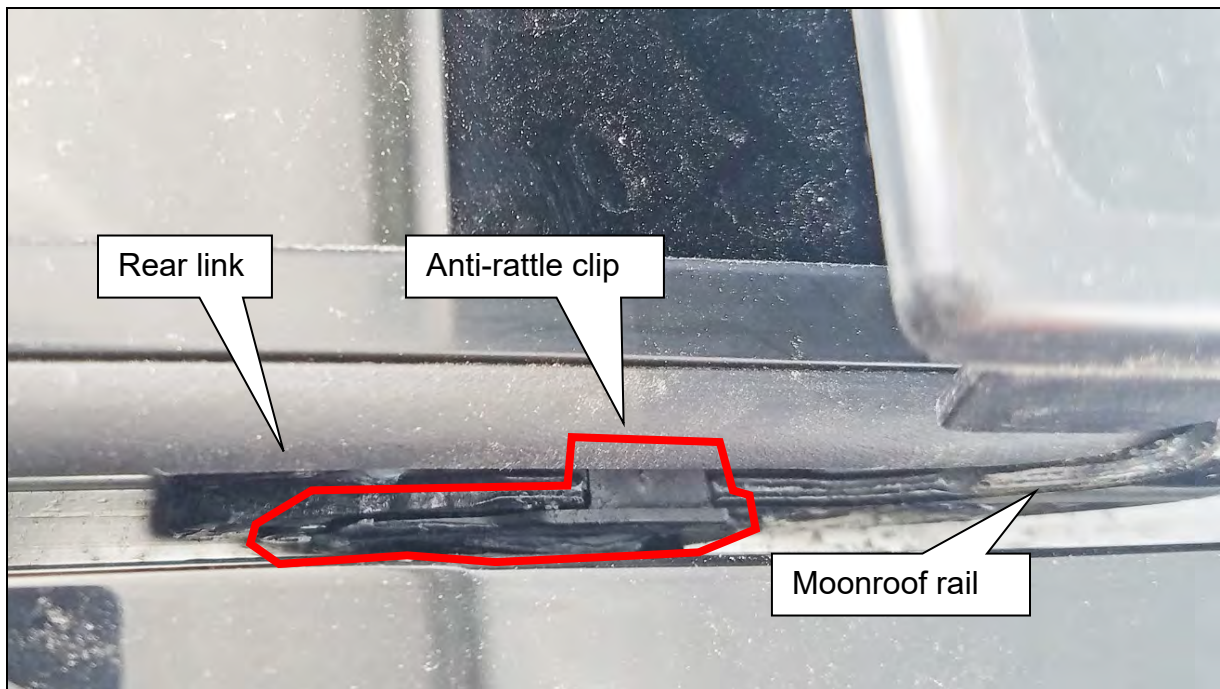

Figure 77

3. Remove the roof finisher seal by slowly lifting UP.

NOTE: Performing this procedure on a warm vehicle will assist in removal.

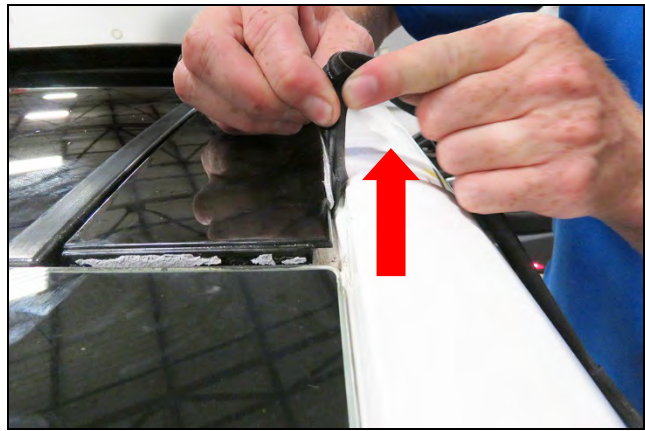

Figure 78

4. Open the Moonroof.

5. Remove the inboard screw (single use T25) securing the front of the roof finisher.

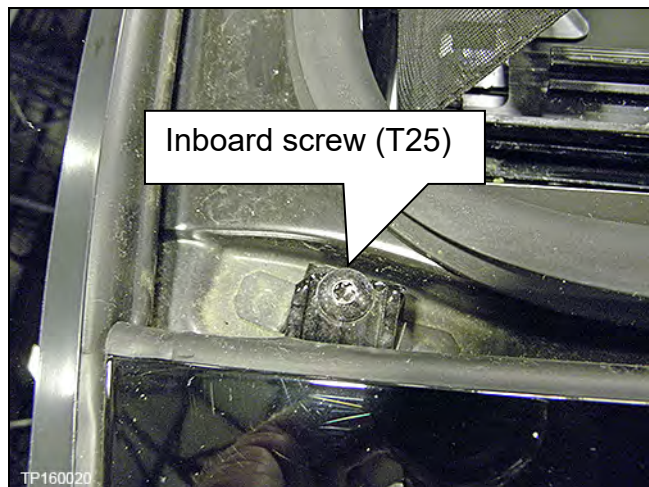

Figure 79

6. Using a finesse stick, lift the roof finisher at the front outside edge.

7. Slide the finesse stick down the length of the outside edge of the roof finisher to detach all pins.

8. Remove the roof finisher.

NOTE: Some vehicles were equipped with adhesive under the roof finishers.

- If the roof finisher released, continue to step 11 on page 41.
- If the roof finisher will not release after the pins have been detached, cut away any adhesive as described starting on the next page.



Figure 80

9. Using an adhesive cutting tool, cut the adhesive between the roof finisher and the roof.

- The red dotted line indicates where the adhesive will be cut in the next step.



Figure 81

CAUTION: Apply tape on the roof to avoid damage to the painted surfaces.

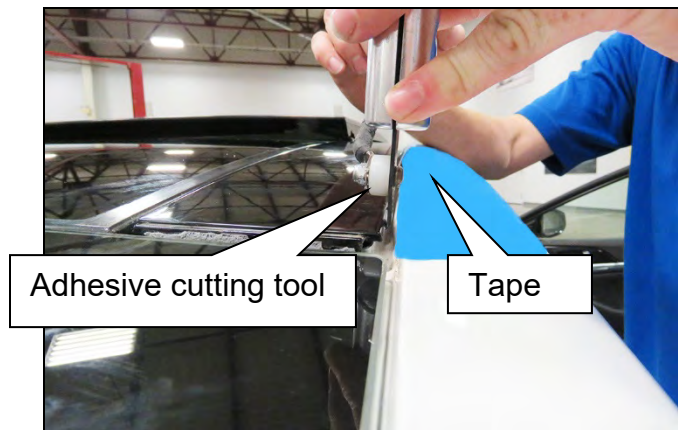

Figure 82

NOTE: It may be necessary to perform this step more than once to cut through all of the adhesive.



Figure 83

11. Using a finesse tool, lift the roof finisher at the front outside edge.

12. Slide finesse tool down the length of the outside edge of the roof finisher to detach all pins.

13. If the roof finisher will still not release after the pins have been released, cut away any adhesive under the roof finisher indicated by the green circles as shown in Figure 84.

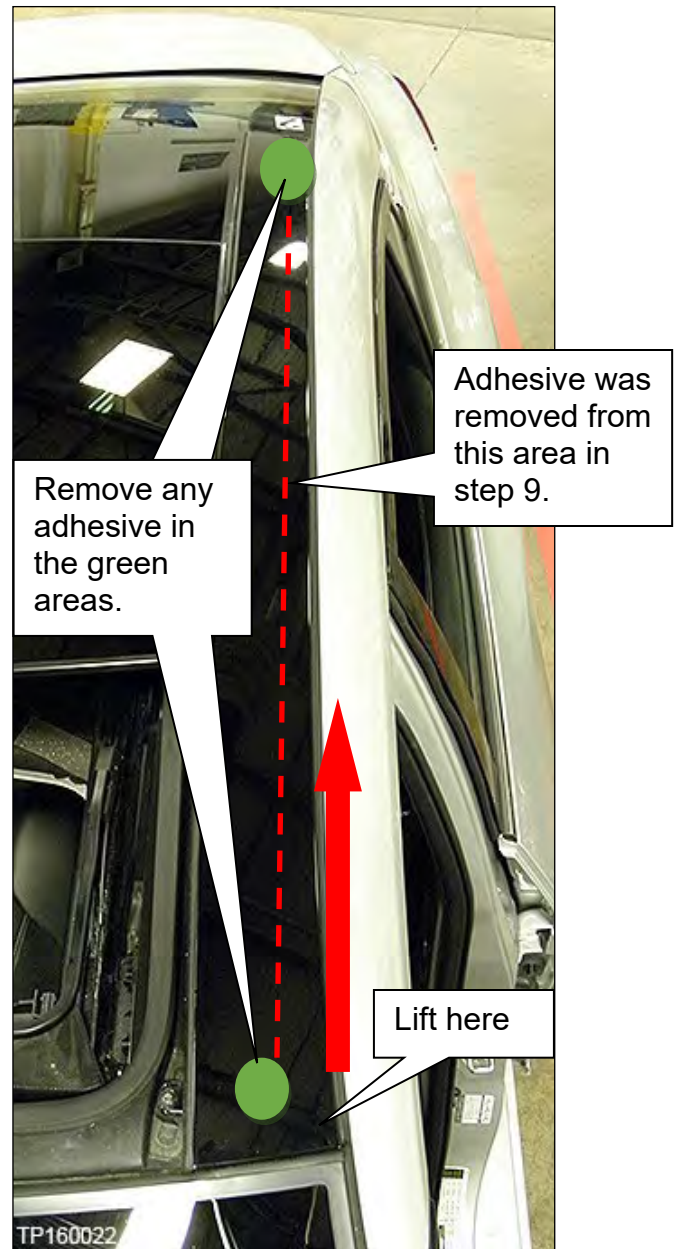

Figure 84

14. Turn the ignition ON.

15. Operate the Moonroof to the tilt position.

16. Remove the Moonroof bolt finisher.

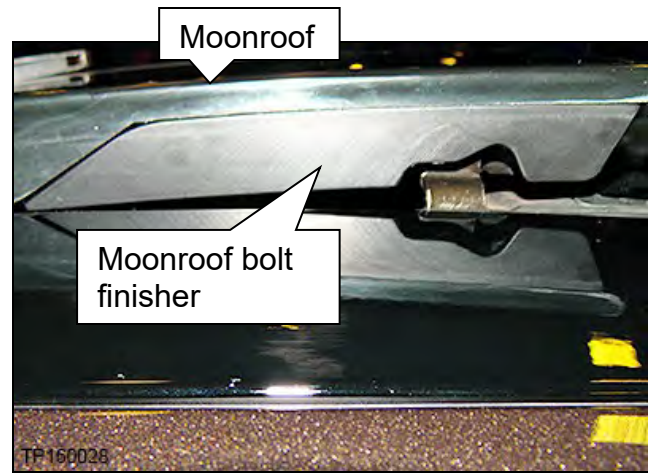

Figure 85

- a. Pull the "Moonroof bolt finisher tab" (plastic tab) down and away from the Moonroof and allow it to rest in the lowered position.

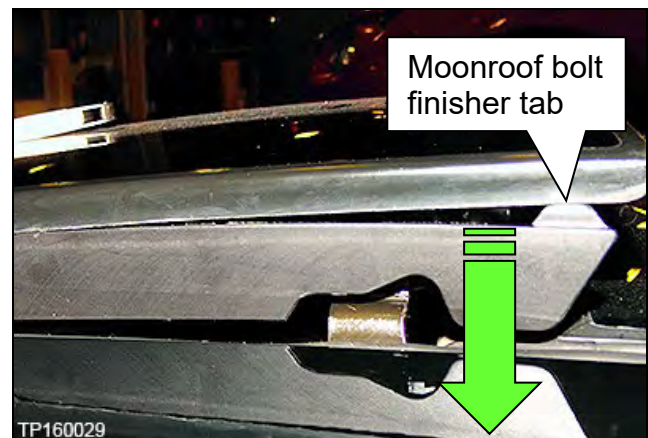

Figure 86

- b. Insert a pocket screwdriver between the Moonroof bolt finisher and the Moonroof in the location shown in Figure 87.
- c. Apply slight downward force to the plastic tab end of the Moonroof bolt finisher until the hole through the steel tab can be seen.
- d. Slide the pocket screwdriver from the plastic tab up to the hole in the steel tab that the Moonroof release clip is connected to.

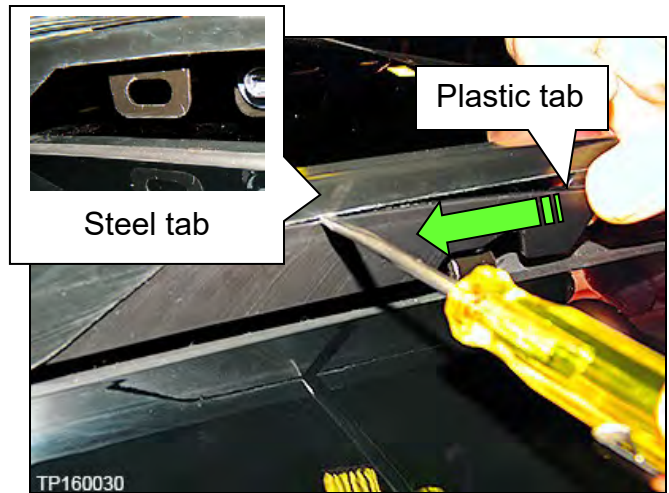

Figure 87

17. Insert the pocket screw driver through the hole in the steel tab to release the retaining clip.

- Figure 88 shows how the retaining clip is released.

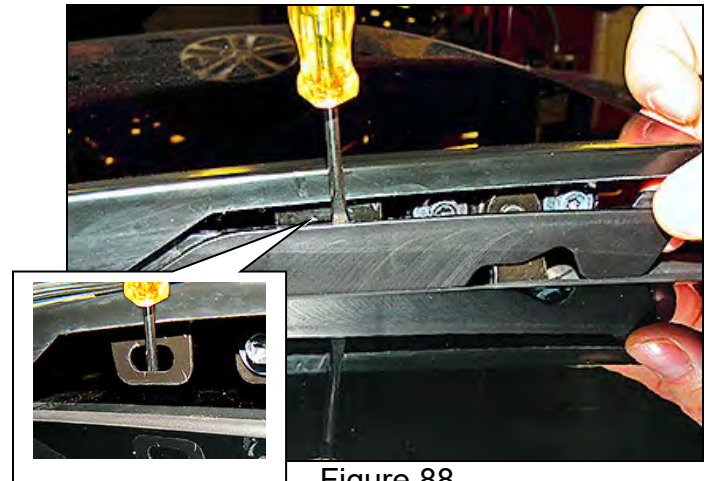

Figure 88



Figure 89

18. Remove the 2 (two) Moonroof adjustment bolts from the rear link.

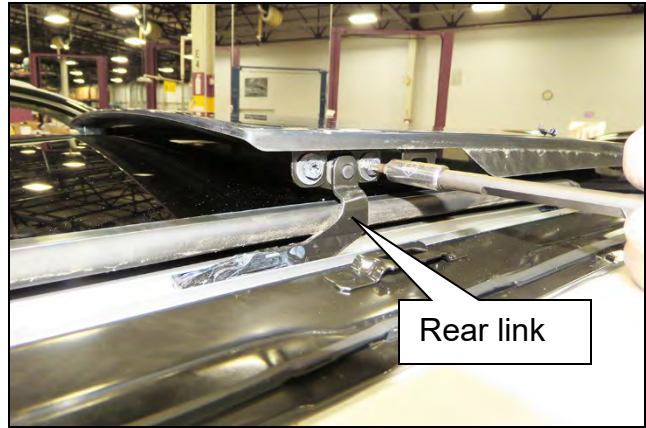

Figure 90

19. Slide the rear link toward the rear of the vehicle and out of the Moonroof rail.

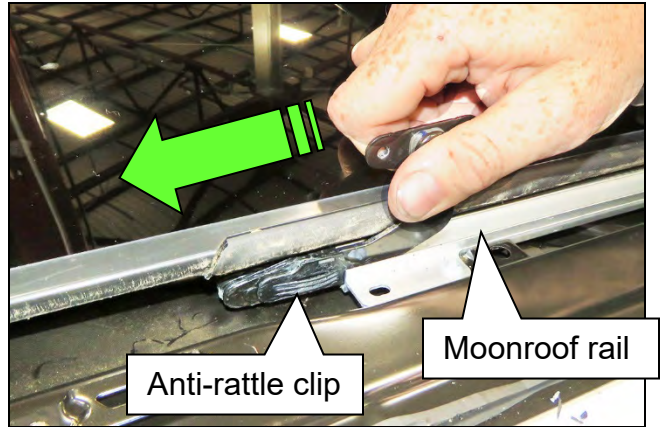

Figure 91

20. Remove any debris / anti-rattle clip material from the Moonroof rail area, outlined in red in Figure 92.

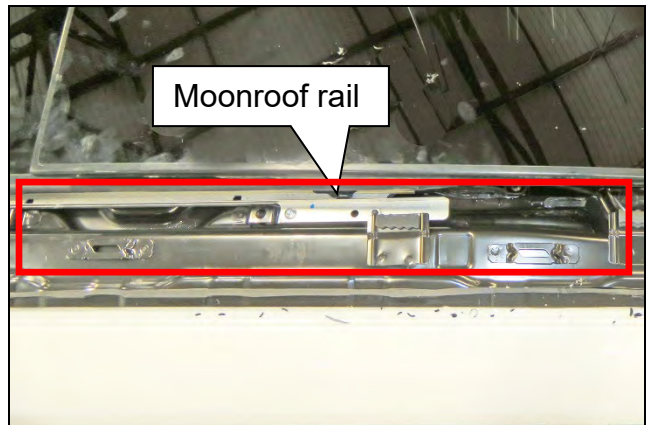

Figure 92

21. Install the rear link into the Moonroof rail.

NOTE: The guide pads on the rear link must compress to fit inside of the Moonroof rail.

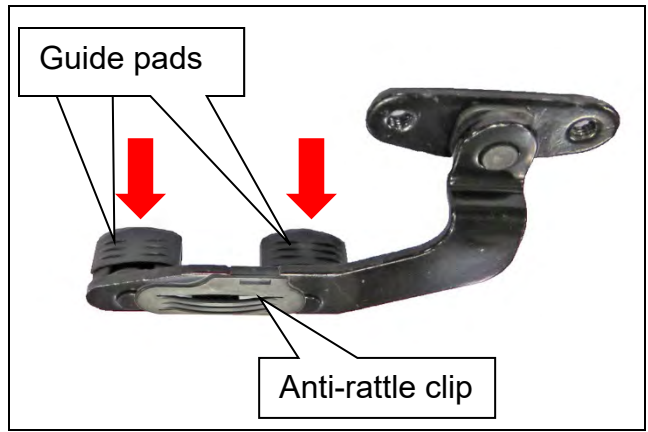

Figure 93

- a. Gently compress the forward most guide pad to insert it into the Moonroof rail.
- b. Gently compress the anti-rattle clip while applying slight pressure toward the front of the vehicle.

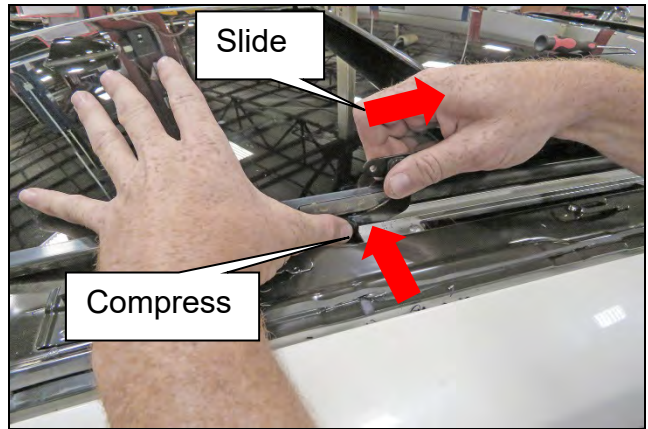

Figure 94

- c. Using a 90 degree pick behind the guide pad will assist in compressing the rearmost pad into the rear link.

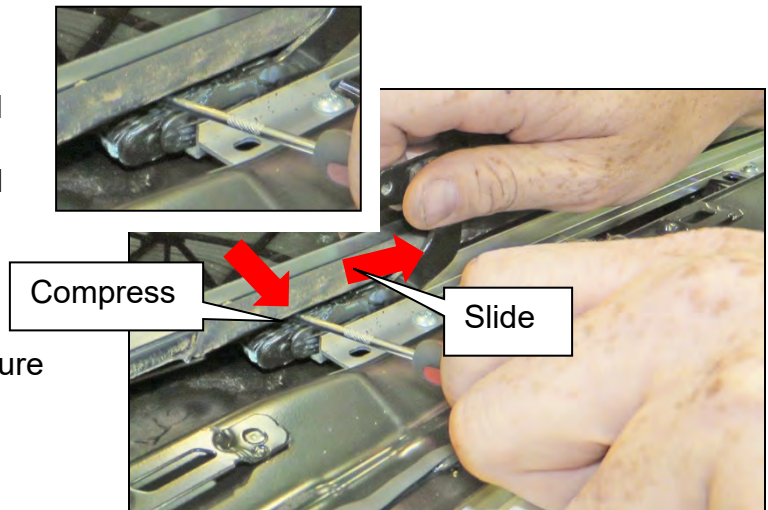

Figure 95

- d. Continue applying slight pressure toward the front of the vehicle.

22. Align the rear link mounting holes with the witness marks to assist in Moonroof alignment.

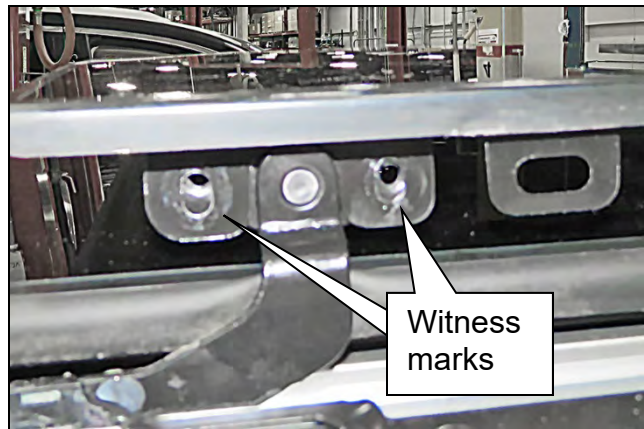

Figure 96

23. Repeat steps 3- 22, starting on page 38, for the other side of the Moonroof if replacing both rear links.

24. Adjust the glass height to the proper position.

- Refer to **Moonroof Adjustment Clearances** on the next page.

NOTE:

- Moonroof adjustment bolts should be slightly snug, not tight, to allow adjustments.
- Work one side at a time to raise and lower individual corners.
- If the Moonroof needs to be moved fore/aft, loosen all adjustment bolts to adjust.

25. Tighten the adjustment bolts.

- Torque bolts to: 5.5 N•m (0.56 kg-m, **48.68 in-lb.**)

IMPORTANT:

- Make sure that the rear link is level.
- Figure 97 is shown with screws removed to overemphasize incorrect pivot angle.

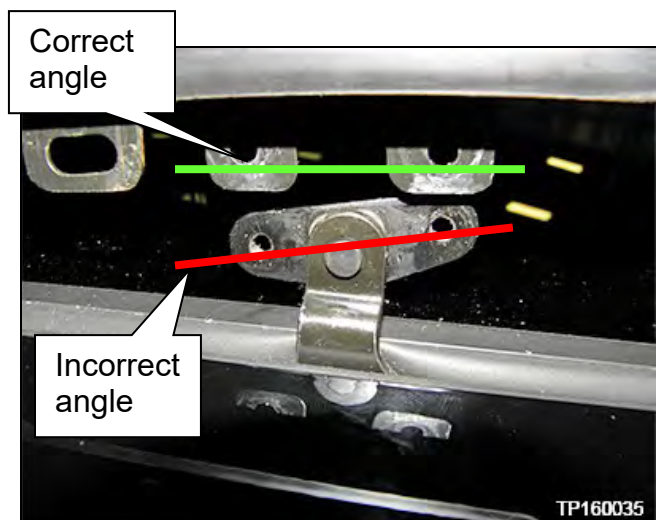
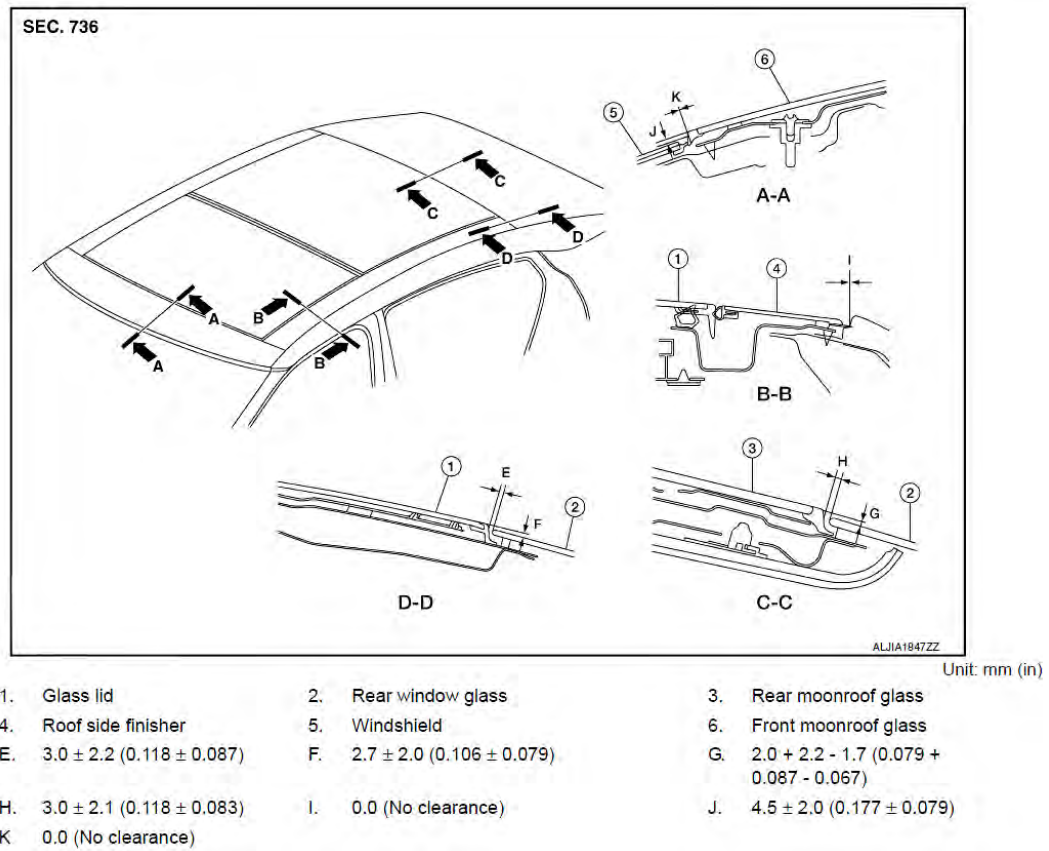

Figure 97

Moonroof Adjustment Clearances



26. Close the Moonroof and check adjustment.

27. Remove the old roof finisher adhesive from the vehicle.

NOTE: Any remaining adhesive residue similar to Figure 98 is acceptable.

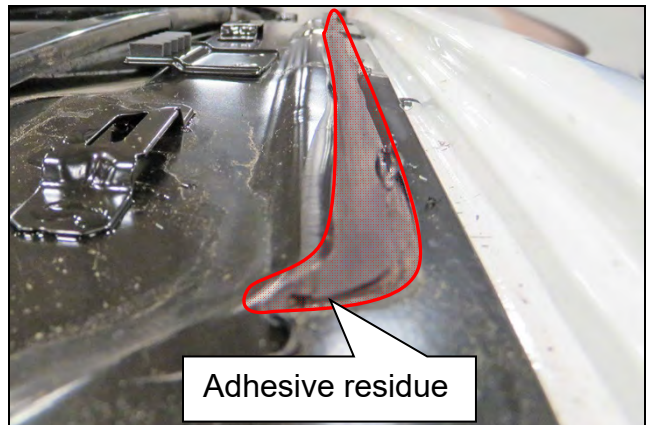

Figure 98

28. Prepare the tip of Betaseal™ 57302N Urethane Adhesive or equivalent.



Figure 99

NOTE:

- To properly install the adhesive, cut a notch in the tip similar to the one shown in Figure 100.



Figure 100

- Using a power caulk tool, similar to the one shown in Figure 101, will aid in adhesive application.



Figure 101

29. Add adhesive to the same locations as the old adhesive.

NOTE: Apply the adhesive ½ inch (13 mm) high.

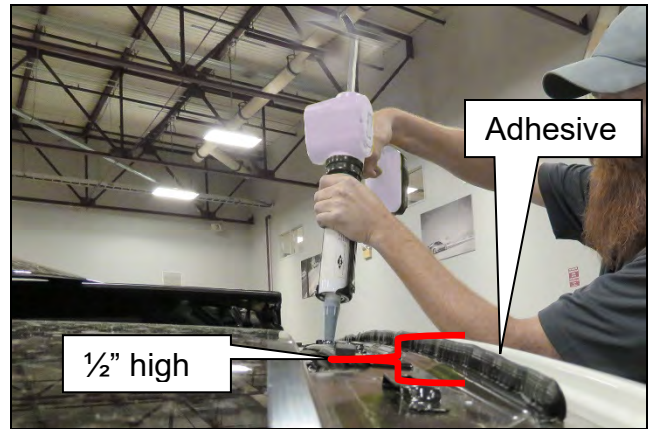

Figure 102

30. Verify the 3 roof finisher pins and 5 spacers have not become separated during roof finisher removal.

- Reinstall any pins or clips that have become separated.
- Verify the 2 rearmost pins are centered in their slots.

NOTE: The forward most pin slot has no adjustment and will fit only one way.

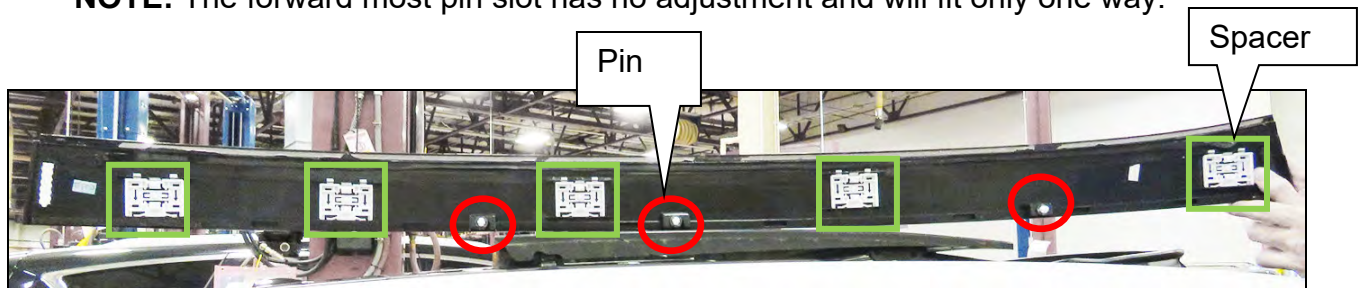

Figure 103

31. Tuck the roof finisher outer seal UNDER the windshield glass seal.

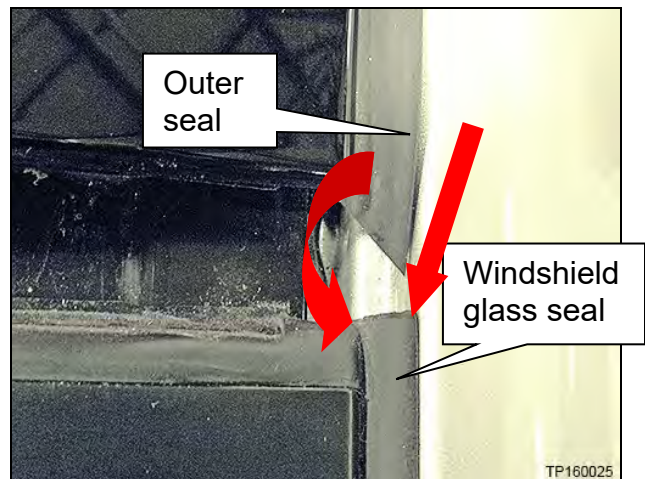

Figure 104

32. Starting from the front of the vehicle and moving rearward, attach each push pin to the roof (Figure 105).

33. After the push pins are all attached, seat all square clips.

NOTE: Excess urethane sealant can hold the roof finisher out of position at the ends and not allow it to be seated. Trimming the extra urethane sealant will sometimes relieve the condition and allow it to seat.

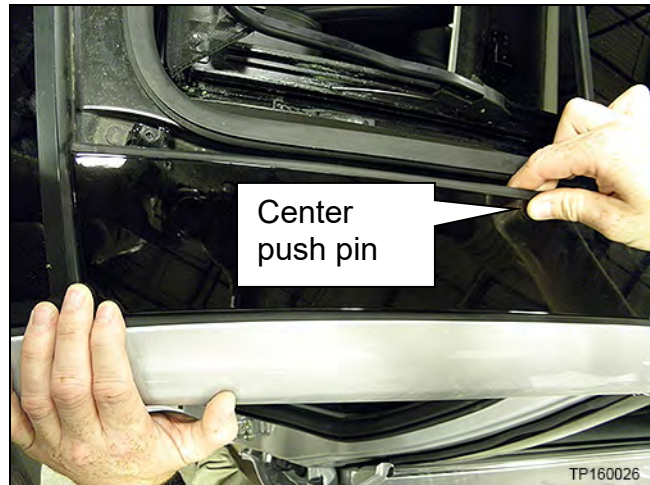

Figure 105

34. Tuck the rear roof finisher seal under the rear window glass (Figure 106).

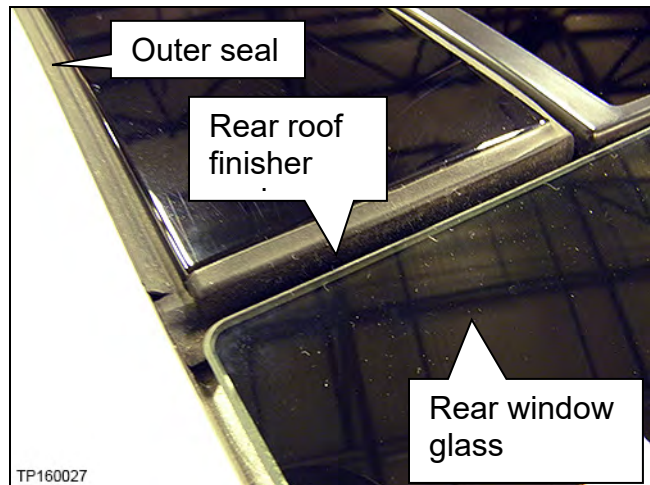

Figure 106

35. Open the Moonroof.

36. Install the new T25 inboard screw into the front of the roof finisher.

- Torque the screw to: 2.5 N•m (0.255 kg-m, **22 in-lb.**)

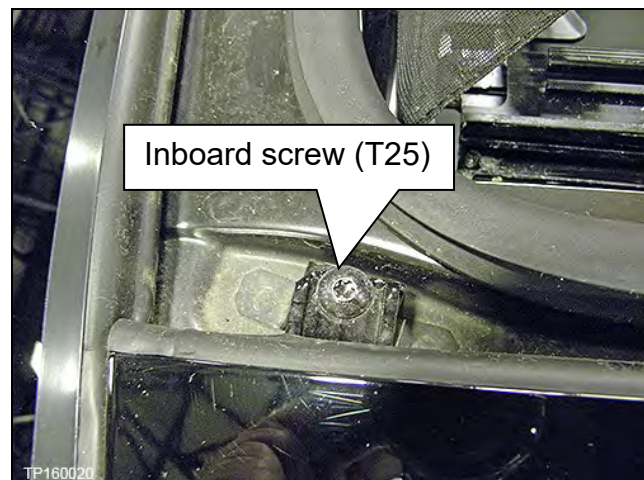

Figure 107

37. Use a finesse tool to tuck the new roof finisher seal into its channel.



Figure 108

38. Operate the Moonroof to the tilt position.

39. Position the new bolt finisher as shown in Figure 109.

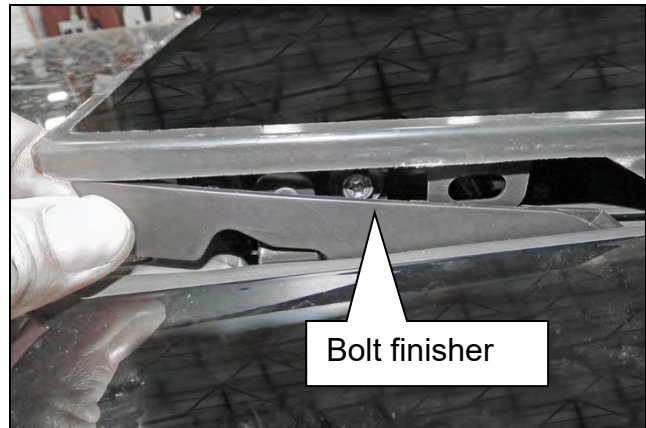

Figure 109

40. Use a finesse tool to lift the bolt finisher UP into position.

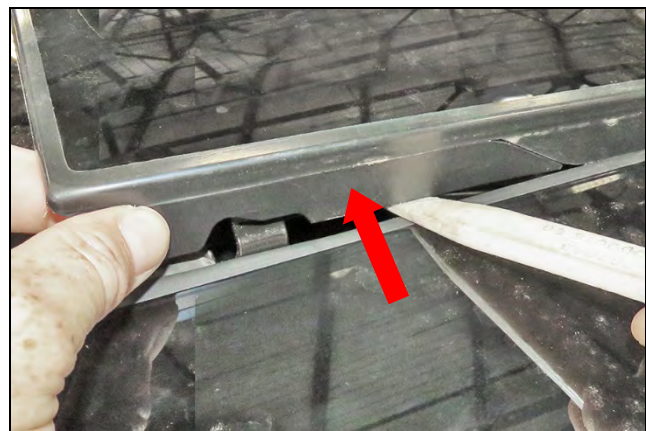

Figure 110

41. Repeat steps 27 – 40, starting on page 47, for the other side of the Moonroof if replacing both anti-rattle clips.

42. Inspect the Moonroof, glass, roof finishers, and surrounding areas for cosmetic damage or adhesive residue.

43. Allow the adhesive to cure for 24 hours.

Moonroof Initialization Procedure

1. Turn the ignition ON.
2. Close the Moonroof glass and power sunshade.
 - a. Press the Moonroof switch in the CLOSE position. Press the switch repeatedly if needed.
 - b. Confirm the glass **is not** in the tilt-up position.

Read steps 3 and 4 carefully before proceeding. Step 4 includes an action that will need to be performed quickly.

3. Press **and hold** the Moonroof switch in the CLOSE position until the glass and power sunshade operates through several small movements (10 - 20 seconds).
4. After the glass has been motionless for 5 seconds, release the switch and within 1 second, press **and hold** the switch in the CLOSE position again.
5. Continue to hold the switch until the glass and power sunshade fully opens and then fully closes.
6. Confirm the Moonroof has successfully initialized.
 - a. Tilt the glass.
 - b. Fully open and close the glass and power sunshade.

NOTE: The rear Moonroof glass is fixed and does not move.

7. Repeat the initialization procedure if the Moonroof does not function properly.

NOTE:

- It may take up to 5 attempts to successfully initialize the Moonroof.
- If unsuccessful after 5 attempts, clear the memory by holding the switch in the OPEN position for 15 seconds. Then, repeat the initialization procedure.

Anti-Pinch Function

1. Fully open the Moonroof.
2. Place a piece of wood near the fully closed position.
3. Close the Moonroof completely with auto-slide close function.
4. Check that the Moonroof opens approximately 150 mm (5.91 in) or reverses for 2 seconds without pinching a piece of wood and then stops.
5. Fully open the sunshade.
6. Place a piece of wood near fully closed position.
7. Close the sunshade completely with the auto slide close.
8. Check that sunshade opens approximately 150 mm (5.91 in) or reverses for 2 seconds without pinching a piece of wood and then stops.

CAUTION: Do not test the anti-pinch function with your hands or other body parts because they may be pinched.

PARTS INFORMATION

DESCRIPTION	PART NUMBER	QUANTITY
GUIDE ASSY-SUNROOF (1) (Right Side Moonroof Cable Repair Kit)	91358-4RA1A	1
GUIDE ASSY-SUNROOF (1) (Left Side Moonroof Cable Repair Kit)	91359-4RA1A	1
DEFLECTOR ASSY-SUNROOF (Moonroof Wind Deflector)	91280-4RA1A	1
FINISHER ASSY-ROOF, RH (Roof finisher Right Side) (3)	91760-4RA3A	1
FINISHER ASSY-ROOF, LH (Roof finisher Left Side) (3)	91761-4RA3A	1
MOTOR ASSY-SUNROOF (Moonroof Drive Motor)	91295-4RA2A	1
MOTOR ASSY-SUNROOF (Sunshade Drive Motor)	91232-4RA2A	1
SHADE ASSY-SUNROOF, FRONT	(2)	1
SHADE ASSY-SUNROOF, REAR	(2)	1
FRAME ASSY-SUNROOF	91300-4RA3A	1
LINK ASSY - GUIDE, RH	91554-4RA1A	1
LINK ASSY - GUIDE, LH	91555-4RA1A	1
PLATE - SUNROOF COVER, RH	91262-4RA3A	1
PLATE - SUNROOF COVER, LH	91263-4RA3A	1
Urethane adhesive (4)	Betaseal™ 57302N Urethane Adhesive or equivalent	As needed

- (1) This kit contains 1 knock. If a right and left knock are needed, both Left Side and Right Side Moonroof Cable Repair Kits must be ordered.
- (2) Refer to the Electronic Parts Catalog for the VIN specific part number.
- (3) This part also includes one single use T25 screw.
- (4) The DOW® automotive chemical Betaseal™ 57302N Urethane Adhesive is recommended. Equivalent products may be used.

CLAIMS INFORMATION

Only Claim for the operations which were actually performed to repair vehicle.

Submit a Primary Part (PP) type line claim using the following claims coding:

OPERATION	PFP	OP CODE	SYM	DIAG	FRT
Replace Knock Insert	(1)	BX5LAA	ZE	32	0.3
Replace Sun Roof Wind Deflector	91280-4RA1A	UQ20AA			(4)
Replace Sun Roof Panel Finisher	(2)	UQ16AA			0.4
Adjust Moon Roof Glass	91300-4RA1A	BX5MAA			(4)
Replace Sun Roof Panel Finisher	(3)	UQ16AA			
Replace Moon Roof Drive Motor	91295-4RA1A	UQ26AA			
RPL Sunshade Drive Motor	91232-4RA1A	UQ27AA			
Replace Link Assy- RH	91554-4RA1A	UQ22AA			
Replace Link Assy- LH	91555-4RA1A				

- (1) Reference the Parts Information Table and use the applicable Part Number (91358-**** or 91359-****) as the Primary Failed Part.
- (2) Reference the Parts Information Table and use the applicable Part Number (91760-**** or 91761-****) as the Primary Failed Part.
- (3) Reference the Parts Information Table and use the applicable Part Number (91684-**** or 91688-****) as the Primary Failed Part.
- (4) Reference the current Nissan Warranty Flat Rate Manual and use the indicated flat rate time.

Expense code:

Expense Code	Description	Max Amount
067	Urethane adhesive	\$4.95

AMENDMENT HISTORY

PUBLISHED DATE	REFERENCE	DESCRIPTION
February 19, 2016	NTB16-017	Original bulletin published
August 12, 2019	NTB16-017a	Updated ROOF FINISHER REPLACEMENT and added REAR LINK REPLACEMENT sections.