



Technical Service Bulletin

SUBJECT:		No: TSB-19-00-014	
GENERAL PDI PROCEDURES FOR 2020 OUTLANDER PHEV		DATE: September 2019	
		MODEL: 2020 Outlander PHEV	
CIRCULATE TO:	<input type="checkbox"/> GENERAL MANAGER	<input checked="" type="checkbox"/> PARTS MANAGER	<input checked="" type="checkbox"/> TECHNICIAN
<input checked="" type="checkbox"/> SERVICE ADVISOR	<input checked="" type="checkbox"/> SERVICE MANAGER	<input checked="" type="checkbox"/> WARRANTY PROCESSOR	<input checked="" type="checkbox"/> SALES MANAGER

PURPOSE



This bulletin contains Pre-Delivery Inspection (PDI) procedures, both technical and detail, specific to the **2020 Mitsubishi Outlander PHEV**. Please refer to the PDI instructions in this bulletin when preparing new Outlander PHEV vehicles for sale and delivery (**in U.S. market ONLY**).

Welcome Delivery folders, containing a Pre-Delivery Inspection form, and a Sales Delivery form, should be used for all PDIs. One is shipped to dealers inside each vehicle.

NOTE: Items shown as underlined and/or in red text are IQS (Initial Quality Survey) sensitive items. Give extra attention to these items for improved IQS and customer satisfaction.

BULLETIN CONTENTS:

BACKGROUND INFORMATION	Page 2
TECHNICAL INSPECTION	Page 3
BEFORE YOU START	Page 4
A. Vehicle Readiness	Page 4
B. Interior Function	Page 7
C. Walkaround	Page 12
D. Under hood & Battery	Page 19
E. Under Vehicle	Page 20
F. Road Test	Page 21
G. Final Steps for Technical Inspection	Page 31
DETAIL INSPECTION	
A. Detailing Before PDI	Page 32
B. Detailing After PDI	Page 34
CUSTOMER DELIVERY PREPARATION	Page 37
COMPLETING THE PDI FORM	Page 40
PARTS INFORMATION	Page 40
WARRANTY INFORMATION	Page 40
SAMPLE PRE-DELIVERY INSPECTION FORM	Page 41

BACKGROUND INFORMATION

The 2020 Outlander PHEV requires specific steps for a thorough PDI. The processes described in this bulletin were developed to ensure a "fault-free" delivery of hybrid vehicles. As in previous PDI instruction bulletins, the Technical and Detail procedures are divided into separate sections.

This bulletin contains general descriptions of most required Technical and Detail inspection checks organized in a logical and time-efficient order. The Technical and Detail procedures are divided into separate sections. It is critical that all the steps are completed **while keeping the vehicle clean inside and out during the entire PDI process.**

The PDI process is important. Remember to:

- Avoid pressure to rush through PDI.
- Never skip steps on the PDI form and always use it to confirm you have completed all steps.

Once you are familiar with these procedures, the PDI form acts as a guide to the process.

Complete the 2018-2019 PDI Technical and/or Detail Test from the Mitsubishi Academy at www.MitsubishiAcademy.com, if you haven't already done so, as well as **all courses specific to the PHEV (Plug-in Hybrid Electric Vehicle).**

NOTE: If any repairs are needed, ensure they are made before the customer takes delivery of the vehicle. Any defects in materials and/or workmanship discovered during PDI should be corrected and claimed under warranty. Adjustments and repairs are not part of the PDI flat rate time.

SPECIAL SAFETY INSTRUCTIONS

WARNING

When charging the vehicle, to reduce the risk of electric shock or fire due to electric leak, always use an outlet protected by a ground fault circuit interrupter (GFCI), rated for 15A or more, that is connected to a dedicated branch circuit.

Wiring harnesses wrapped in orange plastic are high voltage (330V) circuits. Severe or fatal injury can occur if the following precautions are not followed:

- **Always wear insulated Personal Protective Equipment (PPE). These are ESSENTIAL tools and are included with the new dealer tool kit. Missing or damaged tools can be ordered online through the mitsubishidealersolutions.com website, or by calling Bosch Automotive Service Solutions at (888) 727-6672.**
- **Ensure the ground is dry and clear of debris.**
- **If a high voltage connection requires attention, always refer to the Service Manual for instructions, and disconnect the high voltage plug located on top of the main drive lithium-ion battery, behind the center console in the 2nd row floorboard.**
- **Never directly touch any exposed high voltage wiring cables, protective covers detached from high voltage components, or high voltage components that might be damaged.**
- **If leakage of a clear, odorless fluid is observed under the body, it may be electrolyte leaking from the main drive lithium-ion battery. This electrolyte is flammable, and poisonous acid gas will evaporate from the electrolyte. Wear an organic mask, solvent-resistant gloves (or heavy-duty rubber gloves) and eye protection. Use an absorption mat or sand to absorb spilled electrolyte.**
- **If electrolyte comes into contact with your skin, flush with water immediately.**
- **If electrolyte gets into your eyes, do not rub your eyes. Immediately flush your eyes with a large quantity of water and seek medical treatment as soon as possible.**

The following TSBs are quoted in this bulletin. You should be familiar with their details before beginning. All are available on MEDIC.

- TSB-92-51-001, "Paint Damage Identification and Repair Procedures"
- TSB-97-00-006, "Rap-Film and Adhesive Residue Removal Procedures"
- TSB-00-00-002, "Rap-Film Adhesive Residue Removal"
- TSB-09-31-005, "Aluminum Alloy Wheel Cleaning Recommendations and Requirements"
- TSB-12-00-009, "Floor Mat Selection and Installation: Avoiding Pedal Entrapment and/or Interference"
- TSB-12-31-001, "General Service Information for the Tire Pressure Monitoring System - Revised"
- TSB-19-00-008, "Load Carrying Capacity Reduced Label - Revised"

Refer to the following diagram for the basic system components of the Outlander PHEV.

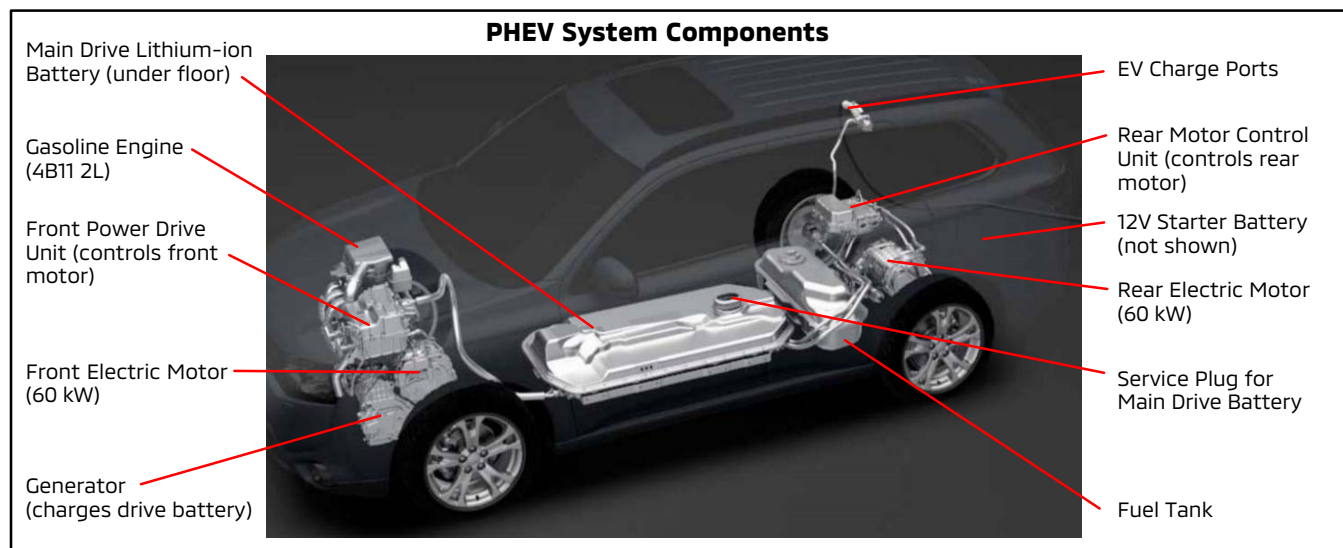

TECHNICAL INSPECTION

The Detail Specialist should complete the "DETAILING BEFORE PDI" section before handing the vehicle off to the Technician for PDI Technical Inspection. Refer to the DETAIL INSPECTION section of this bulletin for complete detailing information for both before and after Technical Inspection.

Use the PDI form and this PDI bulletin as a guide. After completing each step, check off that procedure on the form. The sequence in which you perform the steps may vary depending on your dealership's procedures, facilities, and the vehicle itself. Be sure that all steps that apply are checked on the form. Be sure the PDI form is signed and dated, and copies filed in the "vehicle packet" and service file at your dealership. If you have questions about checking a specific feature or specifications, refer to the Service Manual, new model training guides, and/or the Owner's Manual for details.

!! IMPORTANT !!

DO NOT offer any vehicle for sale if it has an outstanding recall campaign. Doing so subjects the dealer to large fines. Check the Superscreen for possible outstanding recalls.

BEFORE YOU START:

Make sure the following information is recorded in the proper spaces on the PDI form.

- Repair order number
- Dealer stock number
- Model Year
- Ignition key code
- Wheel lock code (if equipped)
- Vehicle Identification Number (VIN)

NOTE: If materials shipped in the glovebox are removed and stored separate from the vehicle due to a dealer's internal procedures, they must be returned to the glovebox prior to retail delivery. This includes: 1) Owner's Manual, 2) Warranty and Maintenance Manual, 3) Tire Warranty Statements, 4) Smartphone Link Display Audio owner's manual, and any other items meant for the customer.

A. VEHICLE READINESS

Before you start the inspection, retrieve the wheel covers, remote transmitters, and any other shipped loose items from the cargo area and/or glovebox as applicable.

1. * IMPORTANT *****

RECALLS - Check the Warranty Superscreen for open Recalls or Service Campaigns. Make sure any open Recall or Service Campaign is performed BEFORE the vehicle is road tested.

The Outlander PHEV is equipped with the One-touch Start System (OSS) (also called Push button starting), used with FAST Key (Free-hand Advanced Security Transmitter).



2. Confirm the IOD connector is firmly engaged (pushed down).

NOTE: The IOD connector is typically engaged at the port.

The POWER switch must be OFF for this step. If the POWER button (also called POWER switch, ignition switch, or electric motor switch) is turned "ON" while the IOD connector is disengaged, a warning message "EV System Service Required" will be shown on the Multi Information Display (MID). This is normal. However, if the IOD connector is engaged (pushed down) with the POWER switch "ON" a DTC will be stored and must be erased before Customer Delivery. To avoid setting the DTC, make sure the IOD connector is engaged only with the POWER switch "OFF."

!! IMPORTANT !! Do NOT remove the IOD connector once it is engaged. For PHEV vehicles, the IOD connector must remain engaged even while in storage. Also, do NOT disconnect the negative battery terminal.

NOTE: If the relay box cover is protected by RAP-film, remove it at this time.



During shipping of Mitsubishi vehicles, dark current is minimized by not connecting the IOD connector. It is positioned in the disconnected position (pulled up) and must be connected by pressing it down for the affected circuits to be completed.

The IOD is a yellow, sliding, fuse holder located in the underhood fuse box. To complete these circuits, push down firmly on the holder until it engages.

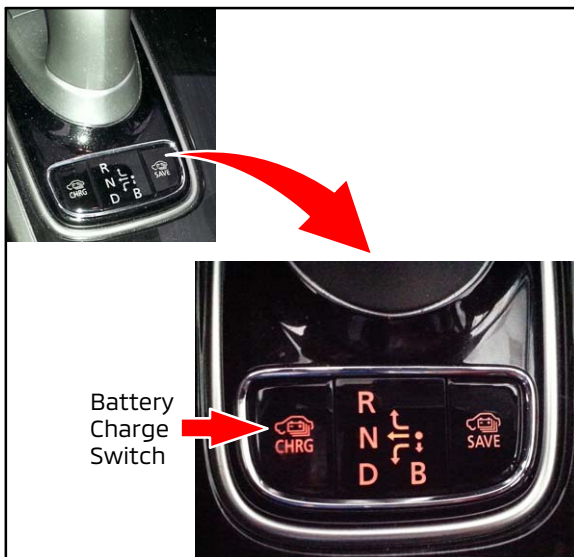

3. **Start the electric motors and engine to check starting performance.**

The electric motors should start quickly using all FAST keys. With vehicle stationary, press the brake pedal, then press the POWER button to the ON position. Then press the Charge switch to start the engine (see step 4 for more details).

If the indicator in the POWER button does not illuminate at all (refer to table below), one or more keys may not have been registered, or there may be an immobilizer system fault. Refer to the Service Manual for diagnostic procedures, and use MEDIC and/or the Mitsubishi Dealer Link (MDL) site to search for TSBs relating to immobilizer key registration policies and procedures.

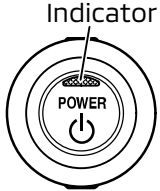
POWER Button	Power Supply Mode	Indicator
	OFF	Not illuminated
	ACC	Illuminated in amber
	ON	Illuminated in blue
	ON (after the plug-in hybrid EV system starts)	Extinguished at 3 seconds after the plug-in hybrid EV system starts
	System error	Flashes in amber

4. **Check the Main Drive Lithium-Ion Battery (traction battery) charge level on the Combination Meter Drive Battery gauge.**

Press the POWER button to the ON position (blue LED). Confirm the battery level gauge on the instrument panel displays sufficient charge to complete PDI. Charge the traction battery if necessary.

- If no segments are displayed, press the Battery Charge switch to start the engine and charge the Drive Battery until 1 segment is shown on the Drive Battery gauge (see below).



- If one or more segments are displayed, press the POWER button to enable "READY" mode and maintain for 30 minutes. This will charge the 12V auxiliary battery.

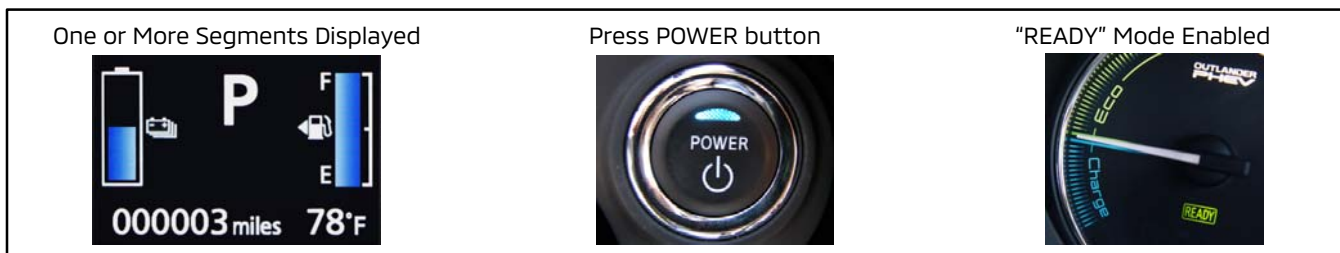

Every 20 days:

- Press the Battery Charge switch, and allow the engine to run for 5 minutes. This action charges the Drive Battery.
 - After 5 minutes, shut the engine OFF. Press the POWER button to enable "READY" mode, and leave in this position for 30 minutes. This action charges the 12V auxiliary battery.
 - After 30 minutes, press the POWER button again to shut the system OFF.
5. Check that the integrated Mitsubishi EV charging cable and the Charging Circuit Interruption Device (CCID) hanging cord are stored under the rear hatch floor panel in the cargo area.

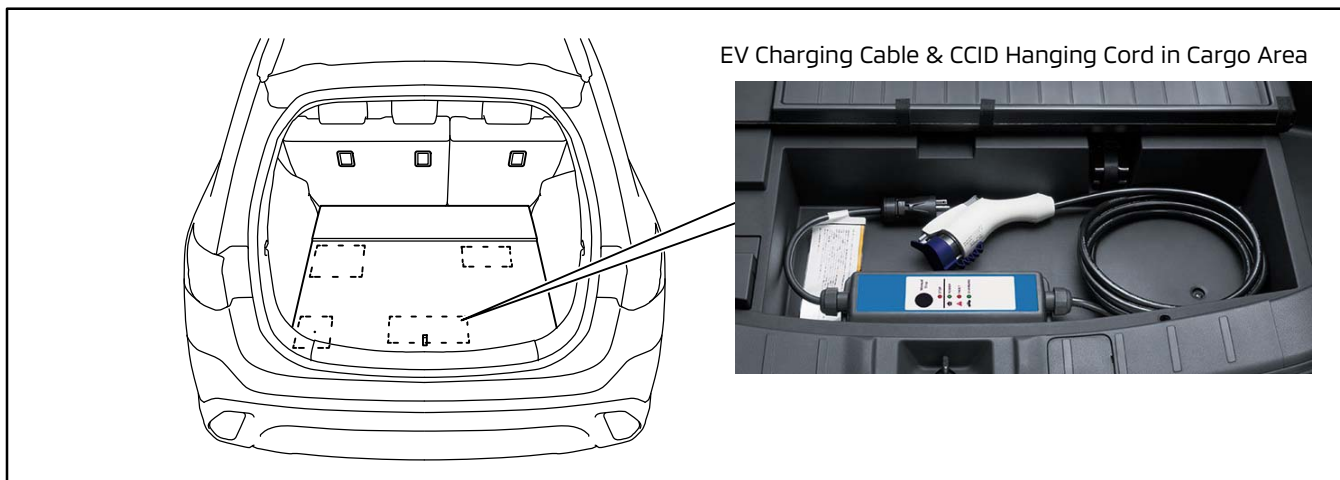

6. **Verify Immobilizer and OSS operation.**

For vehicles with FAST key and OSS, separate the transmitters and enter the vehicle with one transmitter at a time and put the vehicle into "READY" mode. If the vehicle does not display "READY" mode, confirm the IOD has been firmly connected.

7. **Verify presence of all shipped loose items (e.g. floor mats, wheel covers, wheel caps, etc.).**
8. **Refer to MEDIC, or the MDL for any general or model-specific PDI TSBs. Be sure all instructions on those TSBs are performed.**



B. INTERIOR FUNCTION

 **WARNING** Apply the parking brake and put the vehicle into "READY" mode during these inspections.

NOTE: To apply the electric parking brake, pull up on the switch as shown.



1. **Check SEAT ADJUSTMENT, SEAT BELTS, and HEAD RESTRAINTS.**

SEAT ADJUSTMENT and SEAT BELT/HEAD RESTRAINT OPERATION

- Confirm that manual seat track and seat back adjusters operate and lock throughout their entire travel (front seats). Leave the seat height adjuster in the lowest position for maximum head room (if equipped).
- Check power seat operation (if equipped) including seat back adjustments.
- Check power lumbar operation in driver's seat.
- Check heated seat operation (if equipped) in LO and HI settings.
- Check operation and latching of rear (second row) seats.
- Check HEAD RESTRAINTS
Ensure all head restraints are properly installed. Inspect the height adjuster for ease of operation.
- Check ALL SEAT BELTS for condition and operation.
 - Inspect all seat belts to ensure they connect and hold properly.
 - Inspect operation of the shoulder height adjuster and condition of the seat belts, and anchors.
 - Inspect for proper seat belt retraction.
 - Check that safety labels regarding use of seat belts and air bags are in place.

- Make sure the second row seat belts are properly secured in the clips on the quarter trim (if equipped).
- Latch SECOND ROW CENTER SEAT BELT: Due to its unique arrangement, latch the center seat belt for the second row seat for display purposes (refer to TIN-13-52A-001 for details).
- On vehicles with locations for anchoring seat belts when they are not in use, make sure the seat belt ends are properly secured in those positions.



2. **PASSENGER AIRBAG AND SEATBELT LIGHT FUNCTIONS.**

Sit in the front passenger seat and verify the passenger airbag light goes out. Verify the passenger seat belt reminder light comes on when the seat belt is unfastened, and goes off when it is fastened.

3. **HEATED STEERING WHEEL (if equipped).**

Verify proper operation.

4. **Check operation of all WINDOWS, including SUNROOF (if equipped).**

WINDOWS: Check for proper window tracking, complete up and down travel, and proper sealing.

NOTE: Check the lockout and AUTO-down and up functions.

Vehicles equipped with AUTO-up power window function: Ensure the safety mechanism functions normally. Refer to Group 42A - BODY, in the Service Manual for the proper checking procedure.

SUNROOF: Ensure all controls work properly, including one-touch operation. Ensure the sunroof closes tightly, and the tilt-up feature works. Open and close the sunroof two times to ensure the timing of the functions work properly. Refer to the Service Manual and perform the proper test for the vehicle.



WARNING

If the 12V auxiliary battery is disconnected during PDI for any reason, the learned position for the driver's window auto up will be erased, the anti-trap function cannot be activated, and injury or vehicle damage can occur. To reinitialize this position for the driver's window, follow the Learning Procedures of Power Window Fully Closed Position in Group 42A - Body of the Service Manual, then confirm proper operation.

NOTE: If adjustments are required, refer to the appropriate Service Manual procedures and submit a warranty claim for adjustment.

5. **MULTI-INFORMATION DISPLAY (MID)**

Verify the MID screens display in English. If desired, the language can be changed to French, Spanish, Japanese, German, or Italian. Refer to the Owner's Manual for Instructions on changing the displayed language.



6. **INTERIOR AND INSTRUMENT PANEL LIGHTS.**

Check that all interior lights operate:

- [Dome light\(s\)](#)
- [Map light\(s\)](#)
- Vanity mirror light(s) (if equipped)
- Instrument panel illumination and dimmer function
- Door courtesy lights
- Cargo area light (if equipped)
- Sunroof ambient lighting (if equipped)
- Accessory interior lighting (if equipped).
- Glove box light (if equipped)

NOTE: Adjust instrument panel illumination to the brightest level. Position the dome light switch so the light is on when the door is open, and off when the door is closed.

7. **INSIDE AND OUTSIDE MIRRORS.** Ensure the inside rear view mirror holds its adjustment. Make sure the anti-glare function operates properly (if equipped). Make sure the auto-dimming function operates properly (if equipped) by pressing the POWER button (green light illuminates) and covering the front-facing light sensor on the back of the mirror with a black cloth. Press the three Homelink® buttons (if equipped) and check if the indicator light blinks orange. Check and adjust outside mirrors. Check if power side folding mirrors (if equipped) retract and extend during the following operations:

- Pressing the power folding side mirror switch located on the driver's door window switch panel when the POWER switch is in the "ON" or "ACC" position and for approximately 30 seconds after the POWER switch is turned to the "OFF" position
- Extends when the driver's door is closed and the POWER switch is turned to the "ON" position
- Retracts when the POWER switch is turned to the "OFF" position and the driver's door is opened
- Extends when the FAST Key transmitter is used to unlock the doors
- Retracts when the FAST Key transmitter is used to lock the doors
- Extends when vehicle speed exceeds approximately 18 mph (30 km/h)

8. **HORN.** Ensure the horn sounds when the horn pad is pressed.

9. **AUXILIARY ACCESSORY SOCKET(S) & AC OUTLETS (if equipped).**

Check the auxiliary accessory power sockets and AC outlets (if equipped) for proper operation.



a. To enable power to the 120V AC outlets on the Outlander PHEV, press the "AC 1500W" switch in the front instrument panel (below the A/C controls).



b. Verify the outlet(s) function properly when an electrical appliance (e.g., coffee maker, blender, etc.) is connected.

NOTE: For more details on these outlets refer to the Owner's Manual.

10. **AUDIO SYSTEM OPERATION (INCLUDING SIRIUS/XM™ SATELLITE RADIO OPERATION, if equipped), SET CLOCK AND ALL RADIO STATION PRESETS, CHECK REAR ENTERTAINMENT SYSTEM (if equipped).**

Set the clock to the correct time. Set ALL "AM," "FM1," & "FM2" preset buttons to a variety of strong local stations (except Sirius/XM satellite radio, if equipped). Refer to the Owner's Manual for instructions.

Check **radio** and **speaker** operation for:

- Volume
- Reception of AM & FM stations and SIRIUS/XM™ satellite radio (if equipped).
Ensure the satellite radio operates by tuning to channel 184, Emergency/News.
Satellite radio reception must be checked outside with a clear view of the Southern sky.

NOTE: The satellite radio may not operate properly if the vehicle is in an enclosed area. This includes being surrounded by tall buildings. The default location for both units is New York, NY. If this is not your location, move the vehicle to an open area with a clear view of the Southern sky and recheck.

- Tone (bass and treble)
- Balance/Fader Controls

NOTE: Adjust the treble, bass, balance, and fader controls to the center position after radio inspection.

- **AUDIO SYSTEM BLUETOOTH® FUNCTION.**

The audio systems in all 2020 Mitsubishi vehicles have built-in Bluetooth functionality.

There is no separate hands-free module for 2020 models. Check the audio system as described below.



- **SMARTPHONE-LINK DISPLAY AUDIO SYSTEM.**

The Outlander PHEV is equipped with a new generation Smartphone-link Display Audio (SDA) system, with an 8-inch touchscreen, and compatible with Apple CarPlay™ and Android Auto™. Check all functions for proper operation.

Refer to the audio system owner's manual to check smartphone functions, including ability to pair a phone (Apple and/or Android), Bluetooth® connection, and functionality of Apple CarPlay™ and/or Android Auto™.

NOTE: Be sure to erase all test phone data and DELETE the paired phone (that was used for testing) before delivery to the customer.

- Check function of USB ports. These vary by model:
 - SEL and GT: One in the front instrument panel, just below the A/C controls.
 - SEL: Two at the rear of the center console box.
 - GT: One at the rear of the center console box.

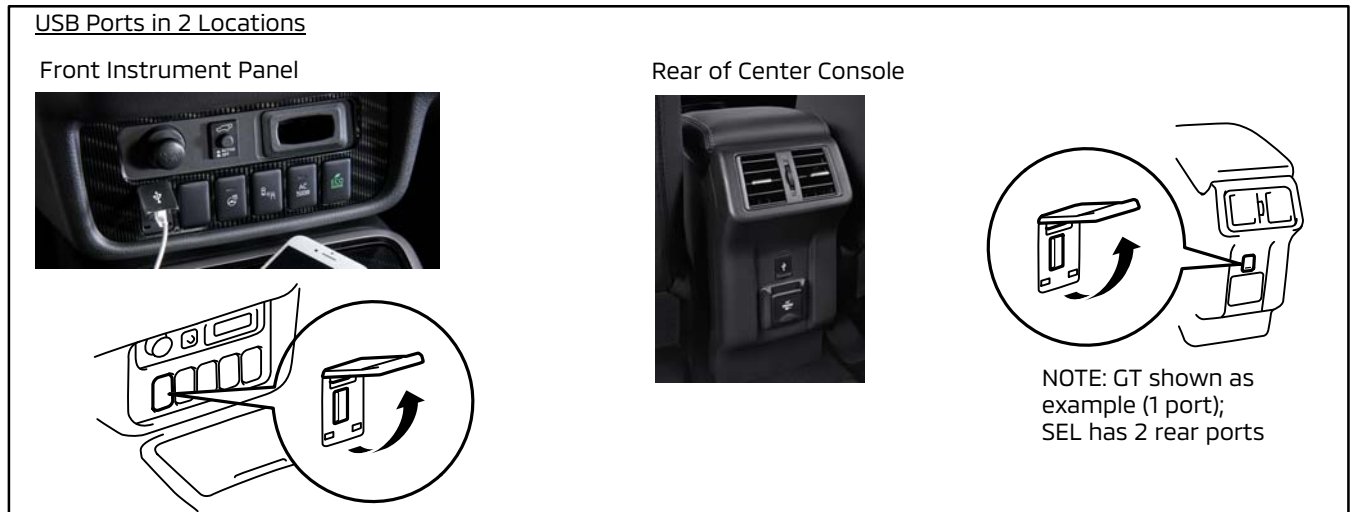

- Check and repair rattling or vibrating speakers
 - Vehicles Equipped with Rear Entertainment System (if equipped):
Confirm operation of DVD player, remote control, and infrared wireless headphones.
11. **REAR-VIEW CAMERA / MULTI-VIEW CAMERA SYSTEM (if equipped).**
- Rear-view camera:
Shift into reverse. Confirm the camera image is clearly displayed on the screen.
 - Multi-view camera (called "Multi Around Monitor" in Service Manual):
Shift into reverse. Confirm rear and side camera views are displayed. Press the switch to toggle between Bird's Eye and Right Side views. Confirm all images are clearly displayed on the screen. Press the Multi-view camera switch again to exit camera view.
12. **BSW/RCTA, ACC, LDW, FCM, AHB SYSTEMS (if equipped).**
- If vehicle is equipped with any of the following systems: Blind Spot Warning (BSW) / Rear Cross Traffic Alert (RCTA), Adaptive Cruise Control (ACC), Lane Departure Warning (LDW), Forward Collision Mitigation (FCM), Automatic High Beam headlight (AHB):
- Confirm that the proper indication appears in the MID when each system is turned on. Refer to the Owner's Manual for details on each system.
13. **WINDSHIELD WIPER DE-ICER (if equipped), REAR WINDOW DEFOGGER AND HEATED DOOR MIRROR (if equipped).**
- Check with the engine running. Turn the windshield wiper de-icer (if equipped) and rear window defogger on, allow time for the windshield wiper de-icer, rear window and mirror elements to warm up and check them during the walk around inspection. Place your hand on the windshield wiper de-icer, rear window defogger and heated door mirrors (if equipped) to ensure they are heating. Be sure to turn off the windshield wiper de-icer and defogger after checking.
14. Turn the POWER switch to the "OFF" position (no illumination on POWER button).



C. WALKAROUND

Before starting this section, make sure the POWER switch is set to the ACC mode (amber LED illuminated on POWER button) and place the transaxle selector in "R" (reverse) with the electric parking brake applied.

⚠ WARNING MAKE SURE THE READY INDICATOR IS **NOT** ILLUMINATED.

1. **Check EXTERIOR LIGHTS.**

Ensure ALL exterior lights, including stoplights and mirror signals, function properly. [Check for chipped or cracked lenses.](#) Verify the AUTO-ON/OFF headlights function properly (refer to the Service Manual for checking procedures).

2. **Check Auto Headlights/Rain Light Sensor (if equipped).**

- With the headlight switch in the AUTO position, cover the sensor with a thick material (like a fender cover) and confirm headlight operation. Uncover the rain light sensor.
- With the wiper switch in the AUTO position, confirm wiper operation when water is sprayed on the upper center of the windshield.

Be sure to shift to "P," turn ALL lights off, and turn the POWER switch to the "OFF" position after completing the inspection.

3. **CHECK SUPPLIED LEVEL 1 & 2 CHARGING CABLE CONNECTION TO CHARGING PORT.**



Charging Port Door

- Unlock the charging port door on the right rear of the vehicle using the Unlock switch on the FAST key remote. Then push the door to open it. Confirm the door opens and closes properly.

Refer to the table below for more details on charging port lock/unlock states.

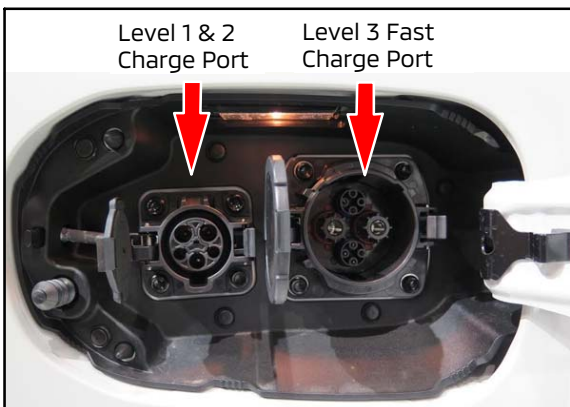

Charging Lid Initial State	CONDITIONS			Charging Lid State
	Driver's Door	Vehicle State	Shift Position	
Unlocked	Open	READY ON or IG-ON	Other than Park	Locked
Unlocked	Closed	READY ON	Other than Park	Unlocked
Unlocked	Open	READY ON	Park	Unlocked
Locked	Unlocked	ACC or IG-OFF	N/A	Unlocked
Locked	Unlocked	IG-ON (READY OFF)	N/A	Locked

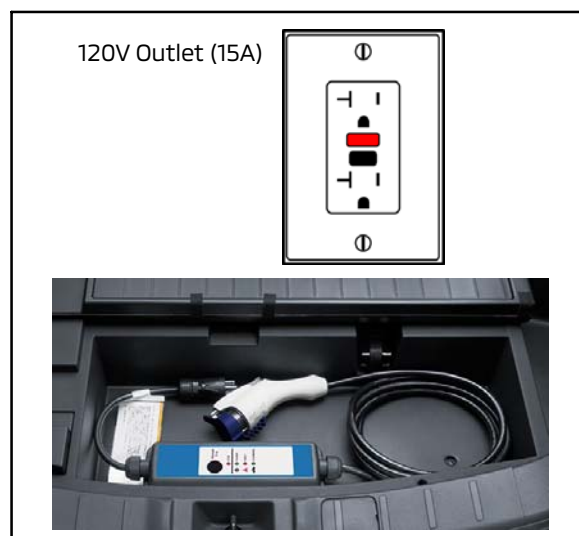

Level 1 Charging (DC-DC): 120VAC Mitsubishi EV Charge Cable

- Locate the desired 120V Outlet (15A) and connect the 120VAC charge cable, confirming it is properly grounded.



Level 2 Charging: 240V Charging Station

- Connect the charger from a 240V charging station to the vehicle (Chargepoint charger pictured as an example).



DC Fast Charging

- If your dealership is equipped with a DC fast charger (Chargepoint CHAdeMO charger pictured as an example), confirm a secure connection with the charge cable to the vehicle.



Check proper connection of cable to vehicle.

- For Level 1, 2, and 3 (if dealer-equipped), confirm the cable locks in place, and releases with moderate effort when the release lever is pressed.

NOTE: For more details on EV charging, refer to the Owner's Manual.



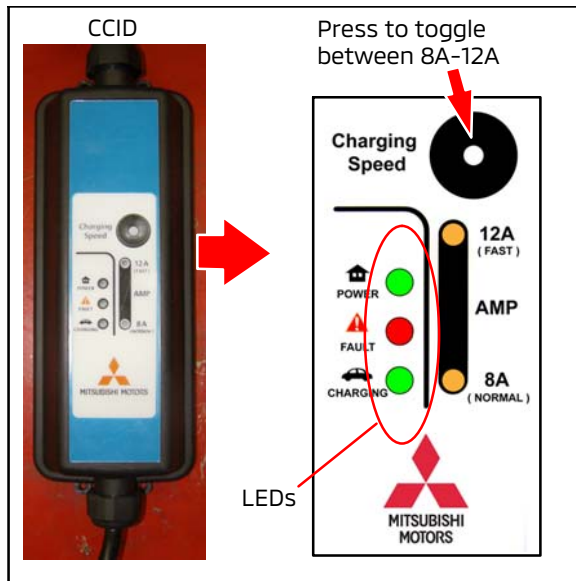

Check Charge Indicator on Cable (Charging Circuit Interrupting Device/CCID)

- Confirm the "POWER" (Green) LED is lit when the plug is connected to an electrical outlet (Level 1).
- Switch between the 8A and 12A settings and confirm both modes can be selected BEFORE connecting charging cable to vehicle.
- Confirm the "CHARGING" LED is lit when the cable is connected to the charging port (Level 1 and 2).
- Refer to the tables below for more details.

POWER 🏠	FAULT ⚠️	CHARGING 🚗	Normal Operation
○	○	○	Every time the EV Charge Cable plug is connected to an outlet, all indicator lights illuminate for 1/2 second then go out.
○	●	●	After initial lamp proveout is completed but the EV Charge Cable is not connected to the vehicle's charge port, or the EV Charge Cable is connected to the vehicle's charge port but no charging is taking place.
○	●	○	Drive battery is charging.
◎	◎	●	The recepticle's ground circuit is disconnected. Check the ground circuit of the outlet being used.
○	●	◎	Charging is complete.

POWER 🏠	FAULT ⚠️	CHARGING 🚗	Abnormal Operation and Corrective Action
○	◎	●	An electric leakage exists or the EV Charging Cable is malfunctioning. Stop use immediately.
○	○	●	EV Charging Cable is malfunctioning. Stop use immediately.
●	●	●	If the indicator lights do not illuminate after connecting the EV Charge Cable to the outlet, check the circuit breaker for the outlet. If the breaker has tripped, the circuit may not be suitable for use with EV Charging Cable. A licensed electrician must inspect and repair the electrical circuit. If the breaker is not tripped, stop using the EV Charging Cable and contact a certified Mitsubishi EV dealer.

○ Illuminated ◎ Blinking ● Not Illuminated

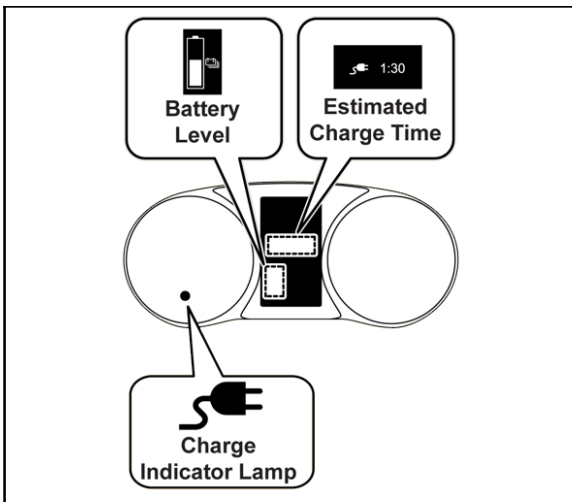

Check Charging Indicators in Multi-Information Display (MID)

- Confirm the battery level and estimated charge time display in the MID.
- Confirm the charge indicator lamp symbol displays in the power meter while charging.

⚠ CAUTION

Before performing the following checks, shift transmission to "P," turn ALL lights off, and turn the ignition switch to the "OFF" position.

4. **FREE-HAND ADVANCED SECURITY TRANSMITTER (FAST) SYSTEM, THEFT ALARM SYSTEM, ALL DOOR LOCKS, LATCHES, ONE-TOUCH START SYSTEM (OSS) & IMMOBILIZER.**

FAST Key

- Ensure door locks operate using the buttons on the FAST key on BOTH transmitters.
- Ensure door locks operate using the lock/unlock button located on the outer driver's door handle and the outer front passenger's door handle.

NOTE: The default for the FAST Key system unlocks only the driver's door when pressing the button located on the outer driver's door handle and all doors when pressing the button located on the outer front passenger's door handle.

NOTE: Factory-installed systems can be customized for various "answerback" responses. Ensure the vehicle's answerback feature is in the full-function answerback mode, where both the horn and parking lamps signal when the doors are locked, and the parking lamps signal when the doors are unlocked. Refer to the Smartphone Link Display Audio owner's manual for programming information.

Theft Alarm (if equipped)

- Lower the driver's window. Turn the POWER switch OFF and remove transmitters from the vehicle.
- Exit the vehicle, close all doors and lock them using the transmitter. The security indicator on the instrument panel remains lit for about 20 seconds and then blinks slowly when armed. For FAST key equipped vehicles, the transmitter must be more than 3 ft / 1m from the vehicle.
- Reach through the open window, manually unlock the door, then open it (hold the transmitter at arm's length away from the vehicle). The alarm should sound and the headlights should flash.

TO DEACTIVATE THE ALARM:

Press the unlock button on the transmitter, or turn the POWER switch to the ACC or ON position (FAST key transmitter must be present).

- Repeat steps a. through c. on the front passenger's door and lock.
- Repeat steps a. through c. using the trunk remote release and trunk lock (if equipped).
- Repeat steps a. through c. on the hood release.

Door Locks and Latches:

Close each door to check the latch and lock mechanisms. If adjustments are required, refer to the Service Manual. Submit a warranty claim for any adjustment performed.

Child Safety Door Lock Operation:

Rear doors should not open from inside when the locking lever (located on the inside rear area of the door near the latch mechanism) is in the LOCK position.

NOTE: Set the lever to the unlock or "FREE" position when you finish.

Fuel Filler Door/Filler Cap:

The Outlander PHEV has a closed fuel tank system to reduce engine operation frequency and improve fuel economy. The internal pressure of the closed fuel tank is higher than a conventional tank. This means the internal tank pressure must be relieved before refueling.



- Push the fuel door release button on the lower dash left of the steering wheel.

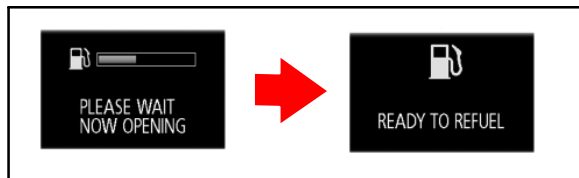

- Once the switch is pressed, the Multi-Information Display (MID) shows the door release progress.
- If internal tank pressure is high, it may take up to 10 seconds before the door is released.

- Check fuel filler cap operation to make sure it can be removed and installed with moderate effort.
- Close the door and verify it latches properly.

5. **LIFTGATE, CARGO AREA LIGHT AND TRIM APPEARANCE.**

Check for liftgate closing quality (make sure it closes easily). Fit should be uniform.



WARNING

Make sure there is sufficient clearance for the liftgate to fully open.

- a. Verify cargo light (if equipped) comes on and all trim is installed properly.



- b. Vehicles equipped with power remote liftgate:

- Press the liftgate master button (located in the front instrument panel below the A/C controls). Confirm the liftgate only works with the master button in the ACTIVE position.
- On the liftgate, press the button next to the license plate lamp to open it.
- When fully opened, press the CLOSE button located to the left of the latch mechanism on the liftgate to close it. Confirm the liftgate latches securely.



- Repeat with the dash mounted activation switch (lower dash, left of the steering wheel).
- Open the power liftgate. While it is opening, stop it with your hand.
- With the liftgate fully open, press the CLOSE button on the liftgate and stop its movement with your hand. It should return to its previous position (closed or open).

6. **EMERGENCY INSIDE LIFTGATE RELEASE HANDLE (if equipped).**

Check the operation of the inside liftgate release handle. Open the liftgate and trip the latch by pushing on the catch with the shaft of a screwdriver to simulate liftgate closure. Remove the screwdriver with the latch in the closed position, and verify the release handle actuates the liftgate release. For more information about the inside liftgate release, refer to the vehicle's Owner's Manual.

7. **TIRE REPAIR KIT, JACK & TOOLS PROPERLY SECURED.**

Tire Repair Kit

The Outlander PHEV does not come with a spare tire. Instead, a tire repair kit is provided to temporarily repair a minor puncture caused by a nail, screw, or similar object.

Verify the tire repair kit is complete and properly stored beneath the floor board of the cargo area (see illustration below). Contents: 12 V air compressor, puncture sealant, speed restriction sticker.

Jack & Tools

Check for jack and tools. For Outlander PHEV, the jack is stored beneath the floor board of the cargo area. The tools are behind the access panel in the right hand quarter trim (see illustration below).

Make sure all tools are properly secured and will not rattle or come loose. Refer to the Owner's Manual for more information.

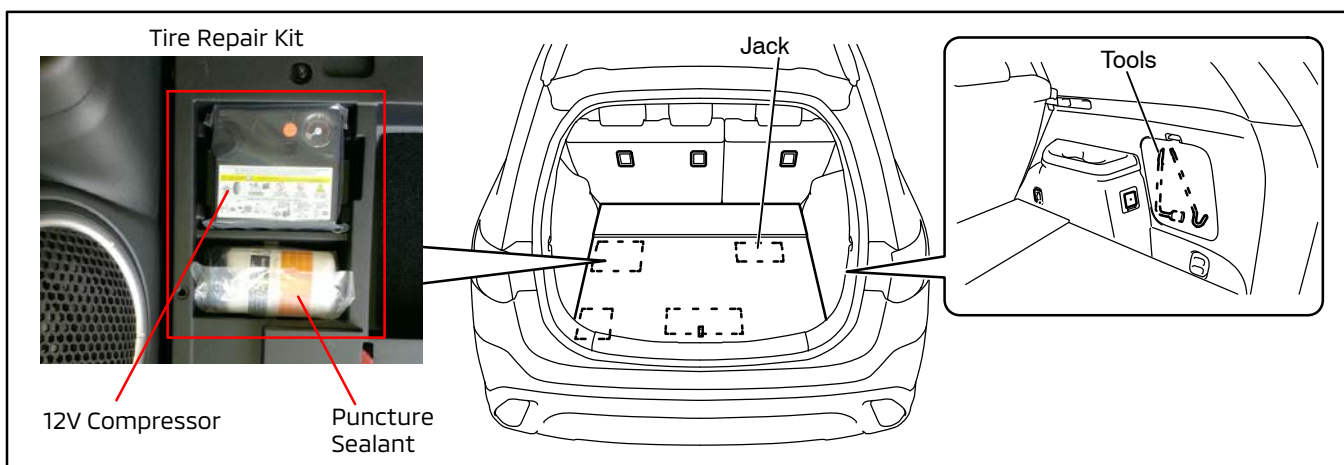

Wheel Lock Key (if equipped)

Confirm the wheel lock key is stored in the wheel lock storage zipper bag.



D. UNDER HOOD & BATTERY



Ensure the POWER switch is in the OFF position (no illumination) when inspecting the following items.



Use MMNA approved fender covers to protect the vehicle body.



NOTE: The Outlander PHEV has a unique engine compartment layout due to the specialized components of this hybrid EV system. The 12V “starter” battery is accessed in the rear of the vehicle, in the back of the cargo area, as shown below.

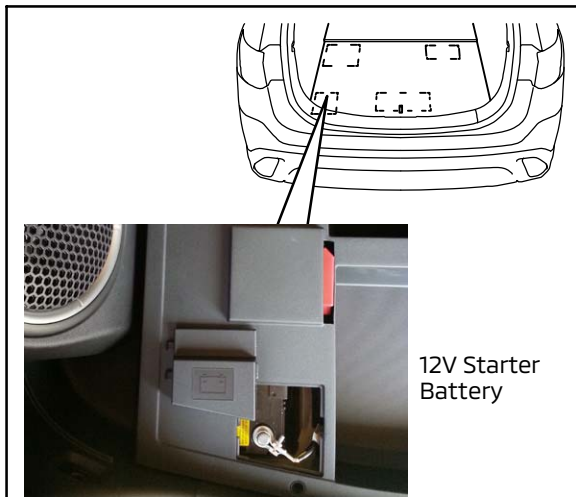

1. Check 12V starter battery charge using the Midtronics Battery Tester.

Make sure that battery cable terminals, and any additional wires attached to the terminals are tight. Make sure the battery is secure.

Ensure the battery is fully charged (minimum 12.6 V). If necessary, follow Service Manual procedures and recharge it. Remove the battery maintenance tag (if equipped) and insert it into the vehicle file with other PDI documentation.

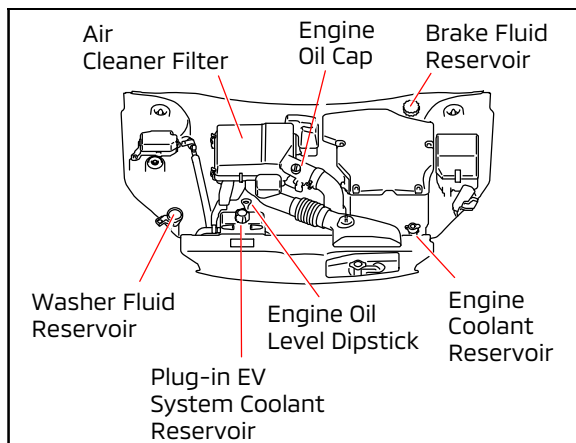

2. Check ENGINE OIL.

Check and adjust engine oil level. If oil is needed, check the under hood label or Service Manual for correct oil specifications. Then add oil if necessary.

3. Check BRAKE FLUID.

Check brake fluid level using the scale on the plastic reservoir of the master cylinder. The level should be at the FULL mark. Add fluid as necessary.

NOTE: Use genuine Mitsubishi BRAKE FLUID, part number MZ311987.

4. **Check COOLANT AND WINDSHIELD WASHER FLUID LEVELS.**

Adjust fluid if necessary.

Coolant: Use only DiaQueen Super Long Life Coolant (genuine Mitsubishi COOLANT, part number MZ320125).

Washer Fluid: Use genuine Mitsubishi Washer Fluid (part number ACH3ZC1X07).

5. **Check for signs of FLUID LEAKS.**

6. **Check for LOOSE ATTACHMENTS, incorrect routing, and insufficient clearances.**

Check for loose parts, wiring harness and cable clips and connections, incorrectly routed hoses and harnesses, and insufficient clearance of components to moving engine parts.

7. **EMISSION CONTROL EQUIPMENT.**

The Environmental Protection Agency (EPA) requires this inspection.

Using the under hood label as a guide, verify all emission control equipment is installed.

NOTE: The EPA requires that dealers visually inspect the emission control devices prior to delivery, or, as an alternative, inspect each vehicle for an illuminated malfunction indicator light (MIL), and if the light is illuminated, diagnose and correct the malfunction.

8. **Check HOOD LATCH AND SAFETY CATCH.**

Make sure the hood release lever pulls evenly and the hood cannot be lifted without releasing the safety catch.



E. UNDER VEHICLE

During PDI, every vehicle should be raised on a lift for under vehicle inspection. Refer to the appropriate Service Manual for vehicle lift points.



WARNING

Take extra care when working near the main drive lithium-ion battery. Electrical connections wrapped in orange plastic carry 330V. Ensure the ground is dry and clear of debris. Wear insulated gloves and boots rated at 600V AC and 750V DC when working near live electrical connections.

1. **Check for LOOSE ATTACHMENTS, incorrect routing, and insufficient clearances.**

Make sure all wiring harness clips, brake pipe clips, heat shield fasteners and any other attachments are properly secured. Check for insufficient clearances and adjust as needed.

2. **Check for FLUID LEAKAGE.**

Check for signs of leaks from engine components, transaxle, fuel lines, coolant hoses, power steering lines, and A/C lines (if equipped). Check lines for twists, kinks, proper routing and clearance to moving parts.

3. **CHECK/ADJUST TIRE PRESSURE AND INSPECT TIRES & WHEELS FOR DAMAGE.**

For tire pressure specifications, refer to the Tire Pressure and Loading label on the driver's side B-pillar.

!! IMPORTANT !!

On some models, the factory over-inflates the tires by 50% to prevent flat spots during shipment and storage. It is critical to adjust tire pressures to the proper specifications.

Check all tires for damage such as cuts, foreign objects in the tire, or any other imperfections. Remove any tire pressure and/or tire balance decals from each tire if present.

NOTE: Low tire pressure on vehicles equipped with a Tire Pressure Monitoring System (TPMS) will illuminate the TPMS warning light. With cold tires, adjust tire pressure on all vehicles to the specification shown on the Tire Pressure and Loading Label. If a valve stem cap is missing, refer to Mitsubishi ASA CAPS and replace it only with the part number quoted for the vehicle. Factory installed valve stem caps are designed to reduce corrosion and damage to the valve. Refer to TSB-12-31-001 for additional TPMS information.

4. **Remove PLASTIC WHEEL PROTECTORS.**

5. **Install wheel caps (if equipped).**



F. ROAD TEST

*** IMPORTANT ***

RECALLS - Check the Warranty Superscreen for open Recalls or Service Campaigns. Make sure any open Recall or Service Campaign is performed BEFORE the vehicle is road tested.

Warning and indicator lights vary by vehicle and equipment, some samples are shown below. Refer to the Owner's Manual and Monroney Label for a complete list for the vehicle.

• Oil Pressure	
• Electronic Power Steering	
• 12V Battery Charging System	
• Low Fuel Level	
• A/T Position Indicator	P R N D B
• Seat Belt Reminder	
• Check Engine	
• EPB / ABS / ASC	
• SRS (Supplemental Restraint System)	
• High Beam	
• Door Ajar	
• Passenger Airbag Light	
• TPMS (Tire Pressure Monitoring System) Light	
• EV Charging System	
• EV System Service	
• Regenerative Brake	RBS
Optional Safety Systems:	
• FCM	• LDW
• BSW	• AHB
• RCTA	• Auto Hold

BEFORE the ROAD TEST:

Vehicles should be at operating temperature prior to performing the following checks. Before beginning the road test, establish a route that you will use for every vehicle. Recommended road test duration is at least 15 minutes and should include a variety of road conditions.

Record BEGINNING mileage

Record the beginning mileage of your road test on the PDI form.

Turn OFF radio before starting the road test.

1. **WARNING, INDICATOR LIGHTS, AND GAUGES.**

- Turn the ignition ON. The indicator and warning lights shown in the illustration should illuminate (as equipped).
- Fasten the driver's seat belt and start the engine. Verify that all indicator lights go out, except the passenger airbag light.
- Unfasten the driver's seat belt and verify the driver seat belt reminder light comes on.
- Open a door. Verify the door ajar light comes on.
- The brake warning light should be lit when the parking brake is applied.
- Verify all gauges and lights are working as equipped.
- Check operation of the seat belt warning buzzer and the key reminder buzzer. For vehicles with the FAST Key system and OSS, move the transmitter out of the vehicle and listen for a warning tone.
- For vehicles with Forward Collision Mitigation (FCM), ensure the FCM light is displayed on the MID when the engine is started. Use the FCM button to toggle the following distance and confirm the change is displayed in the MID.
- For vehicles with Lane Departure Warning (LDW), Blind Spot Warning (BSW), Rear Cross Traffic Alert, Auto Hold: Verify the applicable system light displays on the MID at engine start-up.

Refer to the following diagram for the unique layout of the combination meter for the Outlander PHEV. Items in **red** (numbers 5, 6, 7, 8, 10, 12, and 24) are specifically updated for PHEV operation.

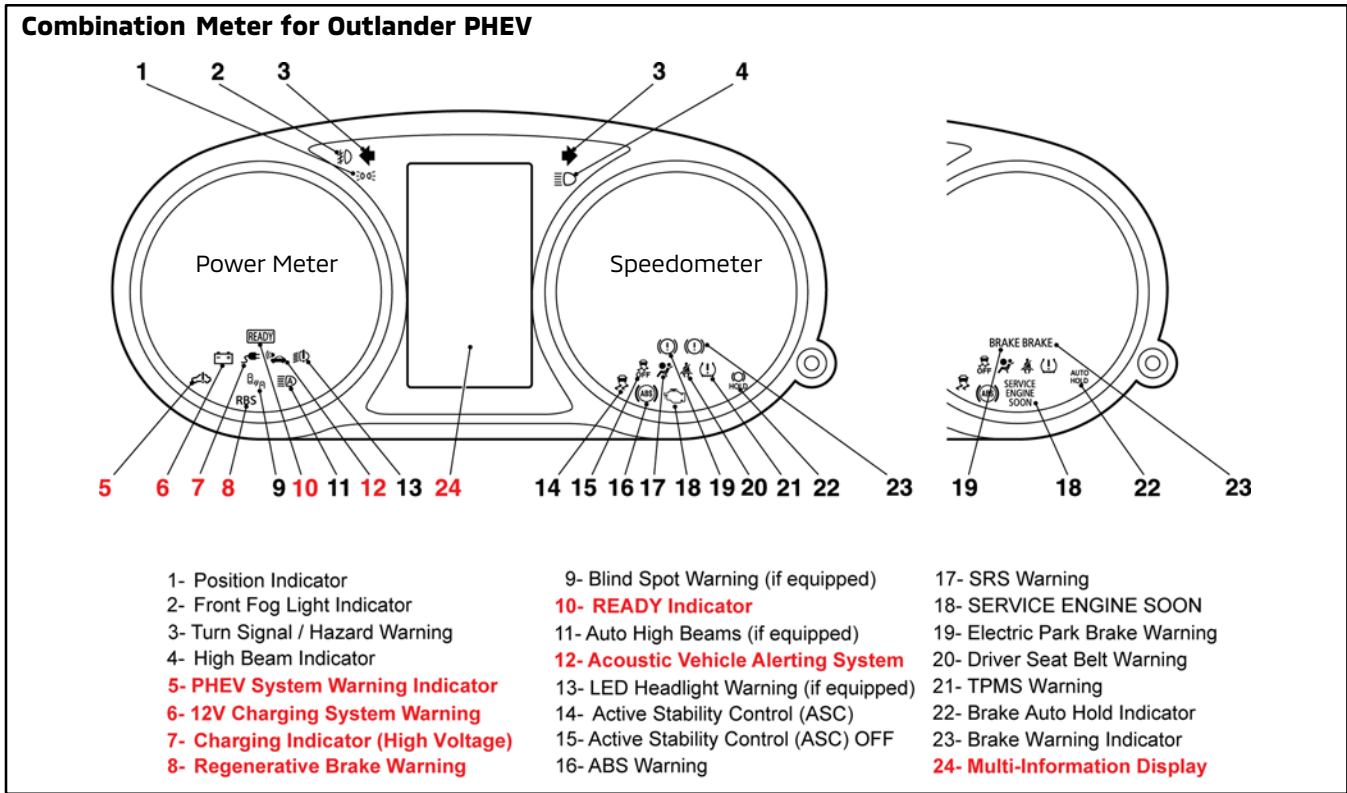

2. Check EV MODE SWITCH, BATTERY CHARGE/SAVE MODES.

EV Mode Switch

Press the "EV" priority button on the center console (below the 4WD Lock switch). and check that "EV" displays on the MID when pressed, and goes off when pressed again.



Battery Charge and Save Modes

CHRG switch:

To charge the drive battery, press the Battery Charge switch with POWER switch ON. The engine will start, powering the generator, charge the battery to about 80% state of charge (SOC).

MID will display the "CHARGE" symbol.

SAVE switch:

To save power in the drive battery, press the Battery Save switch with POWER switch ON. The engine turns the generator to preserve battery SOC. MID will display the "SAVE" symbol.

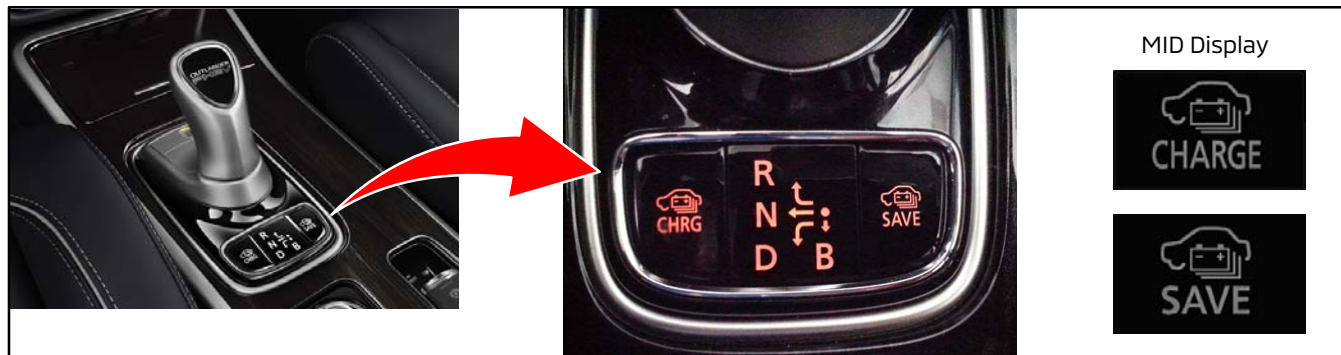

3. AUTOMATIC TRANSAXLE SHIFT SELECTOR (Joystick).

With the brake pedal depressed and the POWER switch in the "ON" position (blue illumination), cycle the shift selector into the following gears and check that they display on the MID: R (Reverse), N (Neutral), D (Drive), B3 (pull down once from "D"), B5 (pull down twice from "D").

NOTE: All Regenerative Braking (B) modes will be checked during the full road test. See step 5 for more details.

CONDUCT A FULL ROAD TEST

Drive the vehicle to identify dynamic symptoms that may need correction. Use the following instructions as a guide.

⚠ WARNING DO NOT ATTEMPT TO TEST ANY SYSTEM THAT CANNOT BE SAFELY TESTED WHILE DRIVING (e.g., COLLISION MITIGATION SYSTEM [if equipped] or ADAPTIVE CRUISE CONTROL FOLLOWING DISTANCE [if equipped]).

⚠ WARNING Your route should be relatively free from traffic so you can safely conduct the test and concentrate on vehicle operation and performance.

⚠ WARNING ALWAYS follow all traffic laws and safe driving practices. The PDI road test should be conducted under a variety of different operating and road conditions.

Vehicles equipped with air conditioning: Place a thermometer in the center vent before beginning your road test. This will be used later to check air conditioner operation.

4. **Check ENERGY FLOW IN MID AND SDA SCREENS.**

The Outlander PHEV automatically selects the most efficient drive mode depending on driving conditions and battery charge condition. See illustrations below for descriptions of the 3 drive system modes. Perform the road test at varying speeds, as shown below, in order to test in all 3 modes and verify the Energy Flow displays in the MID and SDA screens.

EV DRIVE MODES

EV Mode:

All-electric mode with efficient driving performance. Motors drive the vehicle via battery electricity alone.

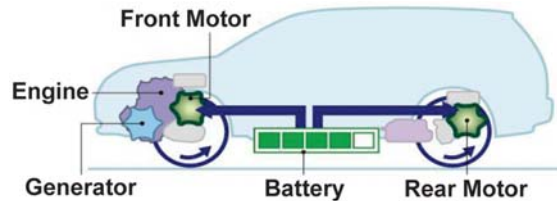

Series Hybrid Mode:

Engine generates electricity. Motors are powered with periodic assistance and drive the vehicle via engine-generated electricity.

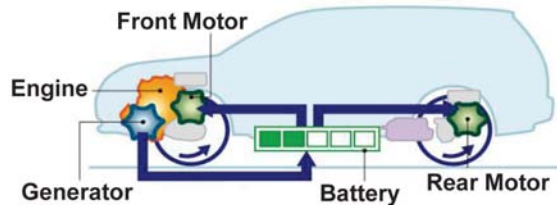

Parallel Hybrid Mode:

Surplus power charges the battery. Engine powered (on highways for example) with periodic motor assistance and battery charging when battery level is low. Engine drives the vehicle with assistance from the electric motors.

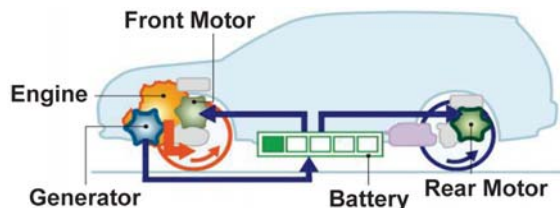

EV DRIVE MODE PATTERNS

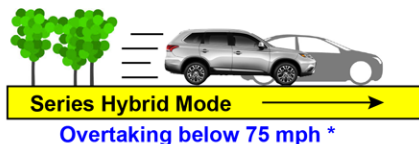
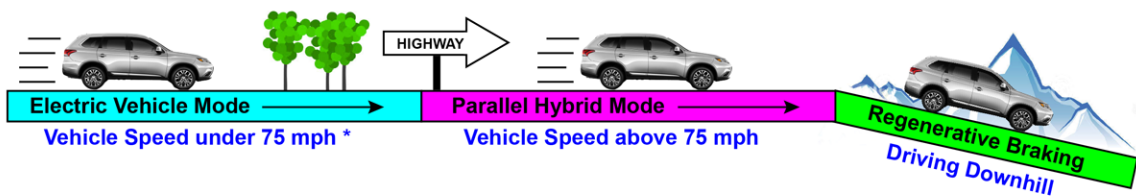

* Depending Upon Battery State of Charge (SOC)

Energy Flow Display on MID

Press the Info button to the left of the steering wheel to change the MID to the Energy Flow Display.

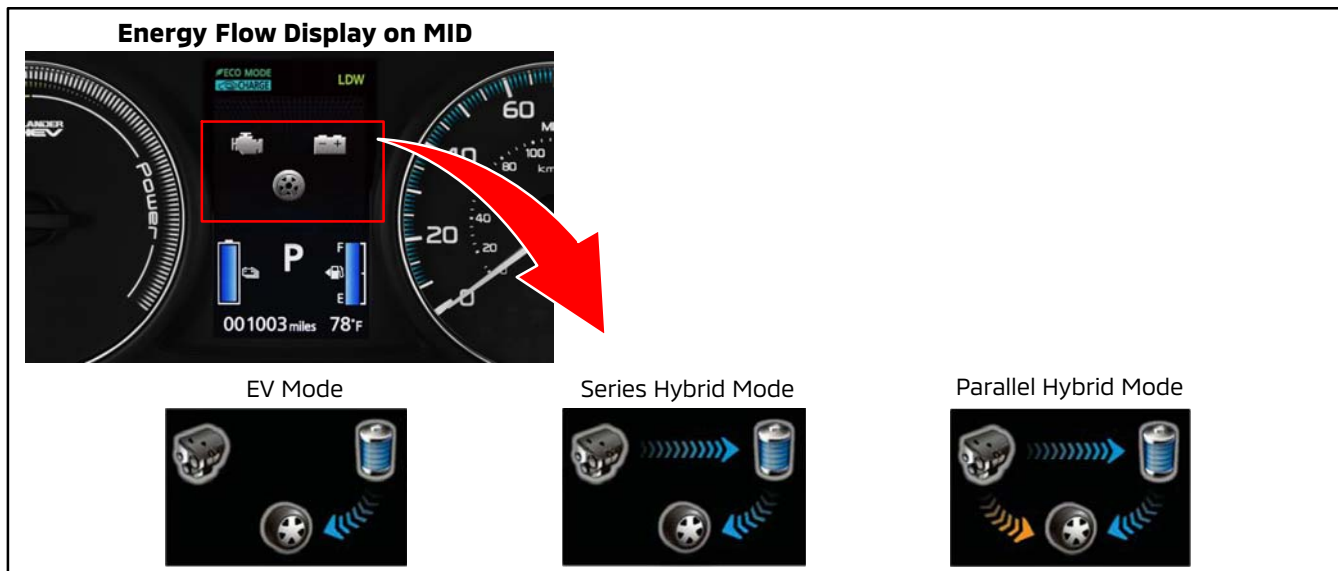

Energy Flow Display on SDA

Press the Vehicle Info button on the SDA touchscreen to view the Energy Monitor, Energy flow, and Eco information screens. For more information on all the available PHEV related display screens, refer to the Owner's Manual.



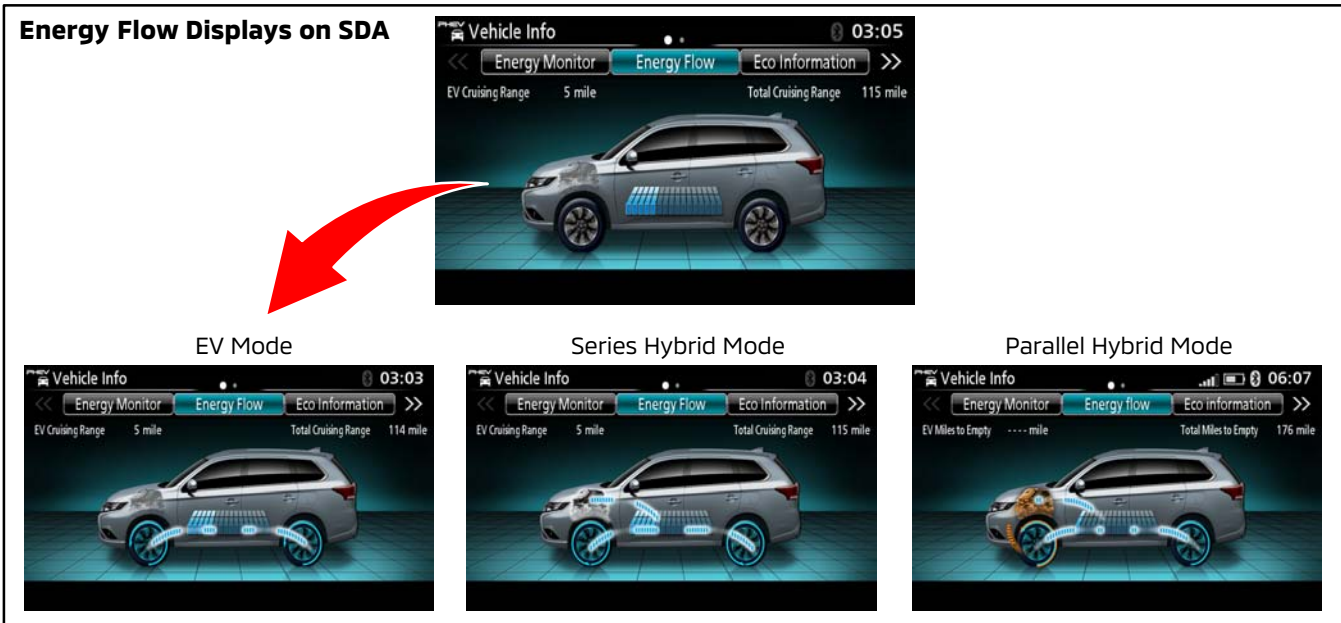

5. REGENERATIVE BRAKING

Check the levels of regenerative braking strength with the shift selector and steering wheel shift paddles.

Regeneration Control - Shift Selector (Joystick)

Pull the selector lever towards you to activate the lower level "B3" regenerative braking. Pull the selector level again to activate the stronger "B5" level. Verify the MID display changes to show the different levels.

Regeneration Control - Shift Paddles on Steering Wheel

Pull on the "-" (down) and "+" (up) shift paddles on the steering wheel. Verify all levels display in the MID as shown as all the levels are selected. (See illustration and table below.) For more details, refer to the Owner's Manual and PHEV training materials.

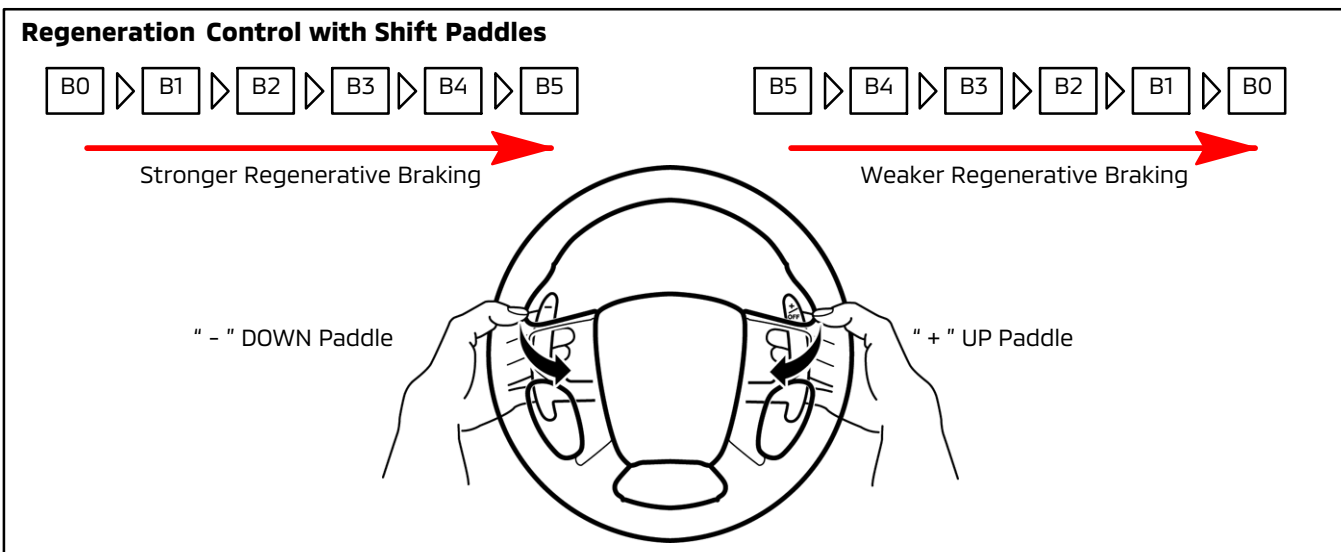

Selector Position		Combination Meter Display	Control
P	Electric Park Switch	P	Electric Park Lock is engaged when this switch is pressed and released only when the selector lever is set to D, N or R (with the Power switch ON).
R	Reverse	R	Vehicle moves in reverse by electric motor only.
N	Neutral	N	No vehicle propulsion is generated.
D	Drive	D	Regenerative braking equivalent to B2.
B	Regenerative Braking (B0 to B5)	B0	No regenerative braking.
		B1	Regenerative braking is activated.
		B2	Stronger regeneration than B1.
		B3	Stronger regeneration than B2.
		B4	Stronger regeneration than B3.
		B5	Stronger regeneration than B4.

6. **SUPER-ALL WHEEL CONTROL (S-AWC) DISPLAY FUNCTIONS.**

Ensure the mode display changes (e.g., NORMAL, 4WD LOCK) when toggling the mode switch.

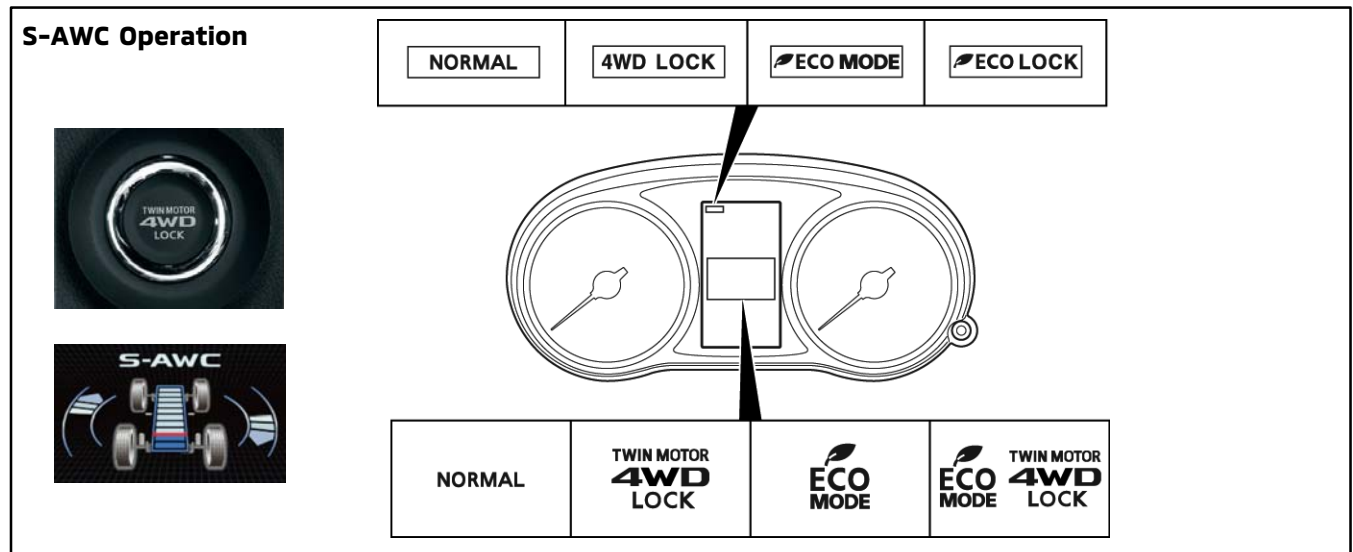

7. **Check ELECTRIC MOTOR PERFORMANCE.**



WARNING

ALWAYS follow all traffic laws and safe driving practices. Check performance under the following conditions. The throttle should respond without hesitation, and performance should be smooth in all conditions.

- **Part Throttle**
At a constant speed of 25-35 mph (40-56 km/h).
- **Under Load**
Accelerate to 3/4 throttle.
- **At Cruise**
At a constant speed of 45-55 mph (75-90 km/h).

8. **Check CRUISE CONTROL.**

Cruise control switches are located on the steering wheel.

Control Functions

On/Off - Energizes and de-energizes the system and turns on the indicator light.

Coast/Set - Sets control speed. Also reduces set speed while engaged.

Acc/Res - Resumes previously set speed. Also increases set speed while engaged.

Cancel - Deactivates set driving speed.

⚠ WARNING DO NOT ATTEMPT TO TEST THE ADAPTIVE CRUISE CONTROL (ACC) FOLLOWING FUNCTION.

System Operation Check

NOTE: Cruise control will not operate below 25 mph (40 km/h).

- a. Accelerate to 30 mph (50 km/h).
- b. Turn on the ON/OFF switch. Make sure the CRUISE light illuminates.
- c. Use the COAST/SET function to set the vehicle speed. The vehicle speed should hold at 30 mph (50 km/h).
- d. Increase the vehicle speed slightly by using the ACC/RES button momentarily.
- e. Check each canceling function by depressing the brake, clutch (M/T only), and the CANCEL button.
- f. Resume the set speed by using the ACC/RES button.
- g. Turn the cruise control off by pressing the ON/OFF switch.

Vehicles Equipped with Adaptive Cruise Control/ACC (if equipped)

Perform checks h-k in addition to those for standard cruise control (above).

- h. Confirm the MID displays the screen for ACC when set.
- i. Confirm the Distance Scale toggles from Near to Far when the ACC Distance switch is pressed.
- j. Press the ON/OFF switch to turn cruise control OFF.
- k. Press and hold the ON/OFF switch until CRUISE displays without the distance scale. The system is now in normal cruise control mode.

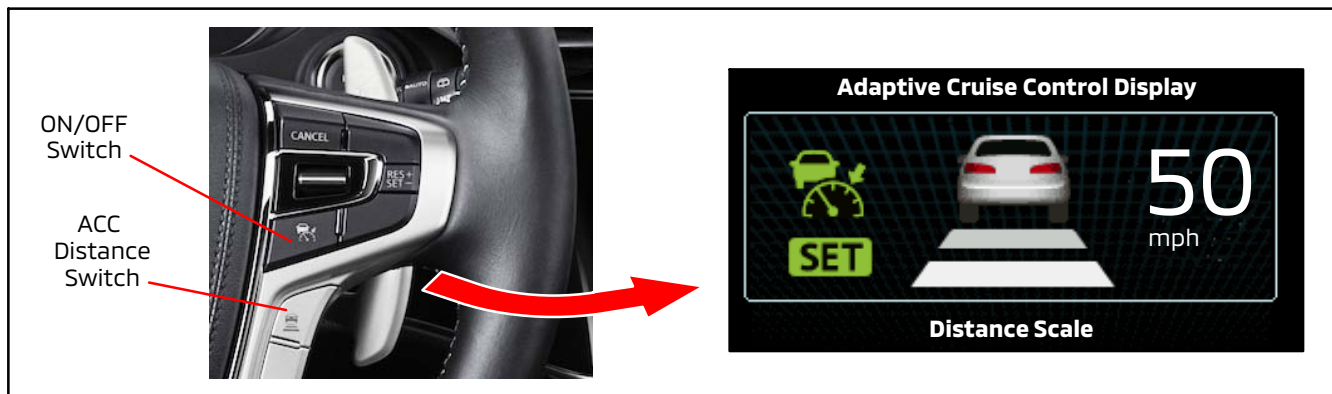

9. **Check AVAS (Acoustic Vehicle Alerting System).**

When driving or when the vehicle is in READY mode, the electric motors are very quiet at low speeds and an audible pedestrian alert system has been added. The alert is heard in forward and reverse gears between certain speeds.

- Check that the alert is heard while the vehicle is in gear, between approximately 0 and 22 mph (0 and 35 km/h) under the following conditions:
 - Brake pedal and parking brake released
 - Selector in D or R
- Check that the alert is not heard at speeds less than approximately 2 mph (3 km/h) with the brake pedal depressed, or above approximately 22 mph (35 km/h) while driving.
- Check that the alert is not heard with the gear selector in Park and engine running.

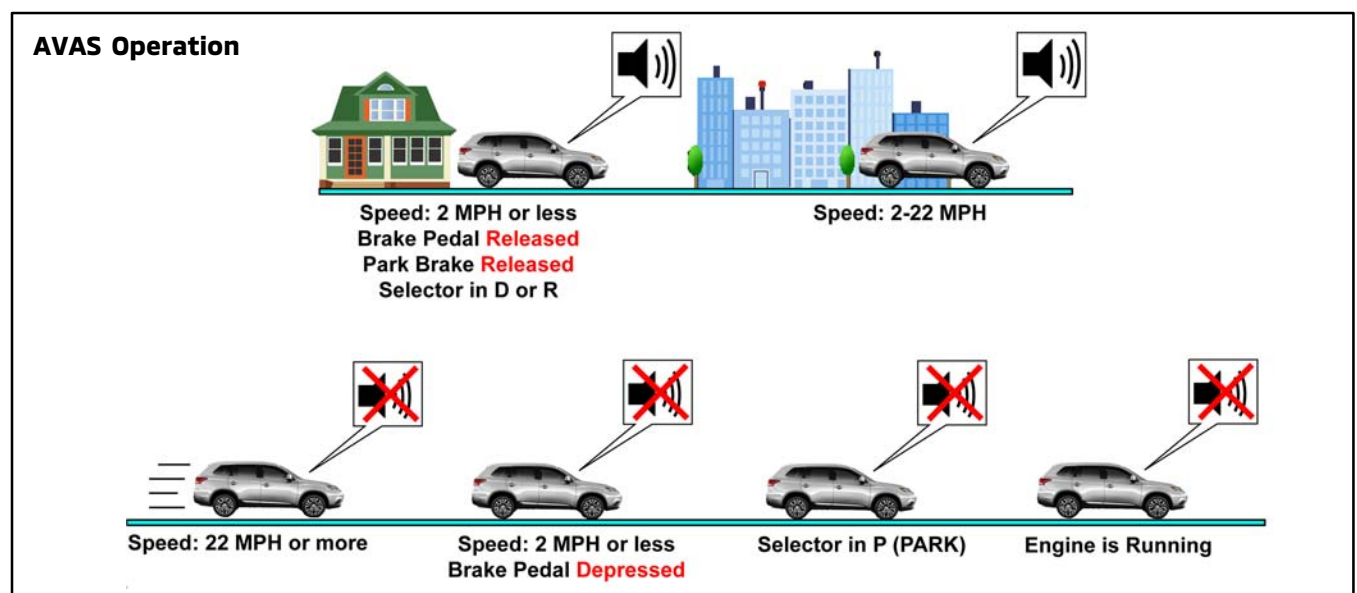

10. **SQUEAKS, RATTLES, AND WIND NOISE.**

Check for any abnormal noise and vibration during your road test, including driveline, pedal, or steering wheel vibration. Listen for rattles and squeaks from interior components (e.g. glovebox, seats). Correct them as necessary.

Be sure to close all windows and sunroof and turn off the audio during this inspection.

11. **STEERING OPERATION, WHEEL ALIGNMENT, and HANDLING.**

Make sure the steering wheel is centered when the vehicle is traveling straight ahead. The vehicle should track straight on a level surface, without pulling or drifting. If a problem is identified, correct it. Refer to the Service Manual for adjustment procedures.

12. **BRAKE PERFORMANCE AND ANTI-LOCK BRAKE SYSTEM (ABS) OPERATION.**

Brake Performance (including ABS/ASC/TCL)

The vehicle should brake smoothly and in a straight line. There should be no abnormal noise (including squeaks) or vibration while braking. The brake pedal should feel firm, not soft or mushy.

ABS Operation



WARNING

Always check that no vehicles are behind you when checking ABS.

In a safe location with no other vehicles or objects around, check the operation of the ABS system. During hard braking, the vehicle should come to a controlled, straight stop. You will feel some pedal pulsation and may hear normal operating sounds from the ABS system.

13. **WINDSHIELD WIPER AND WASHER OPERATION (front and rear)**

Washer Aim (front and rear)

- a. Check washer aim, both front and rear (if equipped).
- b. Vehicles equipped with intelligent windshield washer - Pull the windshield washer lever for approximately 0.5 seconds. Confirm the washer sprays between wiper blade sweeps, for a total of 4 sprays. Refer to the Service Manual (*Group 51 Exterior*) for details of intelligent washer operation.
- c. Make any needed adjustments, referring to the Service Manual. Submit a warranty claim for adjustments performed.

Wiper Operation (including rear if equipped)

- a. Verify correct wiper operation during all speeds. If streaking occurs, clean the wiper blades with a cloth soaked in a mild detergent.
- b. Make sure the wipers park properly.

14. **HEATER AND AIR CONDITIONING (A/C) OPERATION.**

Check for proper operation of all modes, air intake selection, and temperature control. Check the fan speed and check for any unusual fan noises.

Make sure the air intake control is in the RECIRC position. Using the thermometer placed in the center air outlet before the test drive, check for proper cooling when the air conditioner is operating. Refer to the Service Manual for temperature specifications or test conditions for the particular model. When finished, leave the air intake door in the fresh (outside air) position.



15. **Check PARK SWITCH function.**

Place vehicle in Park by pushing the Park switch located forward of the shift lever. The MID should display "P."

Park is engaged either by pressing the Park switch or pressing the POWER switch to OFF. Park is disengaged when the shift selector is moved to the Drive or Reverse position.



G. FINAL STEPS FOR TECHNICAL INSPECTION (After Road Test)

1. Record the ENDING mileage.

Record the ending mileage of your road test on the PDI form.

2. Check ELECTRIC PARKING BRAKE & AUTO HOLD.



- Park the vehicle on a slight incline and leave the transaxle in NEUTRAL. Apply the electric parking brake as shown.
- With your foot off the service brake, the parking brake should hold the vehicle from moving.
- Pull up on the Auto Hold switch and verify that it holds the vehicle from moving on an incline.

3. Check AUTOMATIC TRANSAXLE FLUID.

Check automatic transaxle fluid level as per the Service Manual. Add or extract fluid if necessary to ensure fluid is at the correct level. If necessary, add DiaQueen automatic transmission fluid, ATF SPIII (part number MZ320200).



4. For California Dealers ONLY: Beginning August 30, 2018, a new Proposition 65 warning label must be attached to the driver's side window.

For more details, refer to the Dealer Letter that was sent out August 20, 2018, and reprinted in Tech Talk 241.

5. Sign and install the PDI Quality Assurance Pledge decal.

6. Sign and date the Technician's Signature area on the PDI form. Leave the form with the vehicle for the Detail Specialist to complete "Detailing After PDI."



DETAIL INSPECTION

A. DETAILING BEFORE PDI

BEFORE YOU START:

- **Always keep your hands and uniform clean when performing a PDI.**
- **To protect the interior of the vehicle, be sure to remove sharp objects from your body and clothing before starting the detailing procedures.**

Make sure the following information is recorded in the spaces provided on the PDI form:

- Repair order number
- Dealer stock number
- Model Year
- Ignition key code
- Wheel lock code (if equipped)
- Vehicle Identification Number (VIN)

1. **RAP-FILM REMOVAL (if applicable).**

Before a technician can perform the Technical portion of a PDI, the protective film (RAP-film) must be removed from the **exterior body** surfaces.

NOTE: For easiest removal, RAP-film temperature should be between 32°F (0°C) and 122°F (50°C).



The driver entry area may be protected by a clear RAP-film placed on the scuff plate and/or lower door area. This is to protect the area from damage while the vehicle is available for viewing by customers or in dealer storage, improving Initial Quality Survey (IQS) scores.

THIS AREA SHOULD REMAIN PROTECTED BY THE CLEAR RAP-FILM UNTIL THE VEHICLE IS DELIVERED TO THE FINAL RETAIL CUSTOMER. Please do not remove clear RAP-film from the lower door or sill area prior to retail delivery.

a. **Remove the exterior RAP-film from all body surfaces.**

- If the temperature of the vehicle body is higher than 122°F (50°C), the film softens, allowing more residue to remain on the body surface. For easier removal, decrease the temperature of the vehicle body surface to less than 104°F (40°C) with cool water and/or store the vehicle inside, out of the sun.

OR

- If the body surface temperature is lower than 32°F (0°C), increase the temperature using warm water or put the vehicle inside a heated facility until the body surface temperature rises.

Then, starting at the corners, pull up on the RAP-film, fold it back, and pull it off at an angle of 180 degrees to minimize glue residue.

b. **Wash the vehicle with water.**

NOTE: ALL RAP-FILM MUST BE REMOVED AFTER 5 MONTHS

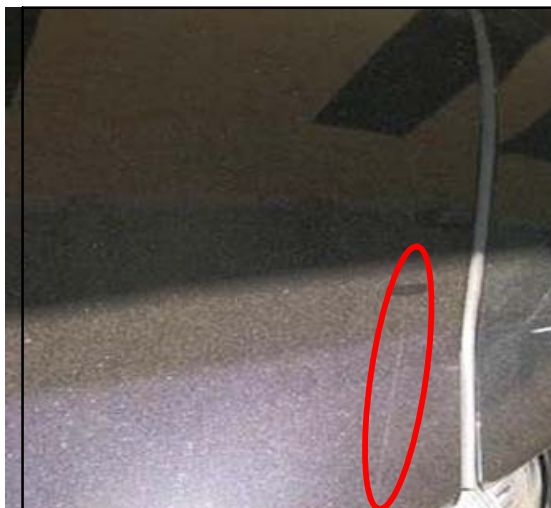

2. **!! IMPORTANT !! Remove RAP-FILM RESIDUE**

A line of adhesive residue can form at the edge of the RAP-film. As the film shrinks due to exposure to the elements, the adhesive is exposed and collects dirt and other debris. Use either of the following methods to remove RAP-film residue from the body surface.

- If there is a considerable amount of residue, remove it by wiping down the affected body surface area with isopropyl alcohol, diluted 50% with mineral spirits (petroleum benzene).
OR
- If there is only a small amount of residue, use a very mild (white) polishing compound on the affected surface area.

For details on removing RAP-film and residue, refer to TSB-97-00-006 & TSB-00-00-002.

3. **Inspect for PAINT DAMAGE.**

- Inspect the vehicle's surfaces for paint swelling (paint will have a milky appearance). This condition occurs when moisture is trapped between the RAP-film and the body panel surface.
- Most occurrences of paint swelling can be corrected by parking the vehicle in bright sun light for approximately one hour.



NOTE: If there is still discoloration or blotching or a "milky" color on the paint surface after RAP-Film removal and cleaning (as shown), DO NOT REPAINT THE VEHICLE. Submit a PRC entry with photos for DPSPM review, then send the vehicle to a body shop that can use an ultraviolet heat lamp to eliminate milky color spots.

For more details, refer to TIN-18-42A-001.

NOTE: If the above repairs are not successful for correcting paint swelling, refer to the paint repair procedures in the Body Repair Manual for the model.

- It is recommended that the Technical Inspection be completed at this time. Continue with the Detailing After PDI section after the Technical Inspection is finished.

Whenever possible, install all accessories and dealer-installed options BEFORE performing Detailing and Final Delivery Preparation.



B. DETAILING AFTER PDI

1. **Remove RAP-FILM (if not already done).** Refer to previous section, "Detailing Before PDI."

2. **Wash ALL EXTERIOR BODY PANELS.**

- a. Always make sure the windows and sunroof (if equipped) are fully closed.
- b. Wash all body panels with water, not in direct sunlight.
- c. Start washing from the roof, working downward, using a sponge and water.
- d. After washing, wipe water from body surfaces using a chamois or soft cloth.

NOTE: When using a high-pressure washer avoid directing high-pressure spray at weatherstrips.

3. **Check for WATER LEAKS immediately after washing.**

In some cases, it may take 4 minutes or longer to produce any evidence of a leak.

During storage, when the vehicle has been exposed to rain with the RAP-film removed, or while washing the vehicle, note any water leaks that may require repair.

Remember, the source of the water leak is not always where the leak appears. To accurately locate and repair a leak, a thorough understanding of the conditions the leak was identified must be made known to the person making repairs.

4. **Wash and inspect ALL WHEELS; THOROUGHLY REMOVE ALL GLUE RESIDUE; Apply TIRE DRESSING.**

- a. Install any missing tire valve caps using the correct cap. TPMS equipped vehicles require specific valve caps. Your parts department can provide the correct part for the vehicle. Refer to TSB-12-31-001 for information.
- b. Wash the wheels with mild detergent and rinse with water. See TSB-09-31-005 for information.
- c. After washing, wipe water from wheels using a chamois or soft cloth.
- d. Inspect wheels and tires for nicks, scratches, and other damage.
- e. Clean off any residue or foreign material.
- f. Apply tire dressing to each tire.
- g. Wipe dry with a clean cloth.

5. **Check DOOR AND TRUNK OPENING CLEANLINESS AND UNDERHOOD CLEANLINESS.**

Wipe off any dirt with a damp cloth.

Under hood

- a. Remove any debris such as leaves, etc. from the engine compartment.
- b. Wipe up any fluid spills and note any evidence of leakage on the repair order.
- c. Wipe down the engine compartment components with a damp cloth.

6. **Inspect PAINT AND ALL BODY PANELS FOR DAMAGE, ALIGNMENT, AND FIT & FINISH.**

- a. Check for scratches and dents. Inspect the body panels from different angles.
- b. Check the alignment of all body panels for uniform gaps and flushness. All body panels should be flush with their adjoining panels and all gaps should be uniform.
- c. Inspect painted surfaces for uniform color. Inspect from different angles.
- d. Inspect painted areas for damage. Note any discrepancies on the repair order.
- e. Inspect painted areas for environmental fallout such as acid rain and rail dust. Remove any fallout by following MMNA-approved techniques.

NOTE: If any paint damage is noted, refer to TSB-92-51-001 and training video #44.

7. **Inspect ALL GLASS FOR DAMAGE AND CLEANLINESS, INSIDE AND OUTSIDE.**

Use a suitable glass cleaner and wipe dry with a soft lint-free cloth.

- a. Use an approved glass polish to remove minor scratches and imperfections.
- b. If there is a problem with any glass, follow your dealer's procedures to correct it.

8. **Inspect ALL MOLDING, TRIM, AND CHROME PARTS, AND REMOVE PROTECTIVE TAPE.**



NOTE: For 2020 model year, the "MITSUBISHI" badge has been eliminated from the rear of the vehicle. Instead, the model name (e.g., Outlander PHEV) is placed on the left side, and the trim badge (e.g., SEL, GT) remains on the right side.

- a. Inspect the moldings, trim, and chrome parts for looseness, proper alignment, and cleanliness.
- b. Clean off any residue.
- c. Note any items that need corrected. Remember, repairs are not part of your PDI time. Follow warranty policy and procedures.

9. **Inspect ALL WEATHERSTRIPPING AND RUBBER MOLDINGS.**

- a. Inspect all weatherstrips and rubber moldings for damage. Make sure they are securely attached.
- b. Clean off any residue.

10. **Clean the INTERIOR and check ALL INTERIOR PANELS AND TRIM FOR PROPER FIT.**

- a. Wipe plastic interior components with a soft damp cloth.
- b. Remove minor stains and soil using a mild detergent, then wipe dry with a clean, soft cloth.
- c. Check alignment of all interior panels and trim for uniform gaps and flushness. All interior panels and trim should be flush with their adjoining panels, and all gaps should be uniform.

NOTE: DO NOT remove the protective seat covers at this time.

11. **Check for STAINS, DIRT, SCUFFS, OR TEARS.**

If stains or soil are found on interior trim, do the following:

- a. Clean with a mild soap solution or reliable vinyl cleaner.
- b. Apply a small amount of solution with a clean cloth or sponge and work into a lather, then wipe with a damp cloth.
- c. When the lather has been removed, wipe again with a soft, clean dry cloth.

NOTE: Damage and/or stains which cannot be removed using the above method should be noted on the repair order and corrected prior to customer delivery.

12. **Check that DOOR EDGE GUARDS ARE IN PLACE.**

Check that door edge guards are in the proper position and securely fastened.

13. **Check CARGO NET installation (if applicable).**

Check that the cargo net has been installed properly at the port.

14. **Install all accessories (if applicable).**

Install any accessories listed on the Monroney label (e.g., cargo tray, cargo mat, all weather floor mats, etc.) according to the instructions in the package or vehicle Owner's Manual.

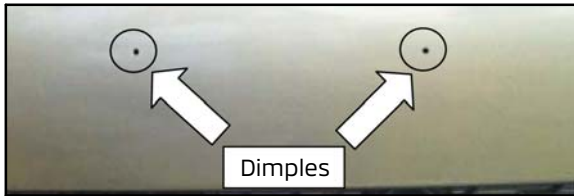

15. **Install license plate(s).**

Install license plate on rear bumper (and front bumper, if required). For states that require front license plates, dealers should use self-tapping screws and mount in the locations indicated by the dimples in the front fascia.

Install using hand tools only.

NOTE: Front license plate brackets and hardware are not shipped with the vehicle. Dealers should use locally sourced, non-corroding M6 fasteners, 20 mm to 25 mm long.

NOTE: For rear license plates, use appropriate size non-corroding fasteners.

16. **Place PAPER MATS IN ALL FLOOR AREAS.**

Install paper floor mats on the driver's side and all passenger areas of the vehicle.



Make sure only one type of floor mat is installed at a time.

17. **Check HEADLINER AND SUN VISOR CLEANLINESS.**

If stains or soil are found on the headliner or sun visors:

- a. Clean with a mild soap solution or reliable vinyl cleaner.
- b. Apply a small amount of solution with a clean cloth or sponge and work into a lather, then wipe with a damp cloth.
- c. When the lather has been removed, wipe again with a soft, clean dry cloth. After cleaning the headliner, use a small brush to raise the nap on the headliner material.

!! IMPORTANT !! Do NOT remove the IOD connector once it is engaged. For PHEV vehicles, the IOD connector must remain engaged even while in storage. Also, do NOT disconnect the negative battery terminal.



CUSTOMER DELIVERY PREPARATION

1. **Wash ALL EXTERIOR BODY PANELS.**

- a. Always make sure the windows and sunroof (if equipped) are fully closed to prevent water entry.
- b. Wash all body panels with water, not in direct sunlight.
- c. Start washing from the roof, working downward, using a sponge and water.
- d. After washing, wipe water from body surfaces using a chamois or 100% cotton terry towel.

NOTE: When using a high-pressure washer avoid directing high-pressure spray at weatherstrips.

2. **Wash ALL WHEELS AND APPLY TIRE DRESSING.**

- a. Install any missing valve stem caps with the correct cap. TPMS equipped vehicles require specific caps. Your Parts department can provide the correct part for the vehicle.
- b. Wash the wheels with mild detergent and rinse with water. See *TSB-09-31-005* for information.
- c. After washing, wipe water from wheels using a chamois or 100% cotton terry towel.
- d. Apply tire dressing to each tire.
- e. Wipe dry with a clean cloth.

3. **Check DOOR AND LIFTGATE OPENING, AND UNDER HOOD for CLEANLINESS.**

Wipe off any dirt with a damp cloth.

UNDER HOOD:

- a. Remove any debris such as leaves, etc. from the engine compartment.
- b. Wipe up any fluid spills. Note any evidence of leakage on the repair order.
- c. Wipe engine compartment components with a clean damp cloth.

4. **Inspect ALL BODY PANELS FOR DAMAGE AND ALIGNMENT.**

Check for scratches and dents. Inspect the body panels from different angles.

5. **Inspect ALL PAINTED SURFACES FOR DAMAGE AND FINISH QUALITY.**

- a. Inspect painted surfaces for uniform color. Inspect from different angles.
- b. Inspect painted areas for damage.
- c. Inspect painted areas for environmental fallout, such as acid rain and rail dust. Remove any fallout by following MMNA-approved techniques.

NOTE: If any paint damage is noted, refer to TSB-92-51-001 and training video #44.

6. **Clean ALL GLASS (INSIDE AND OUT); Inspect ALL GLASS for DAMAGE.**

- a. Use a suitable glass cleaner and wipe dry with a soft lint-free cloth.
- b. Clean any dirt off the wiper blades.
- c. Use an approved glass polish to remove minor scratches and imperfections.

7. **Inspect ALL MOLDING, TRIM, AND CHROME PARTS.**

- a. Inspect the moldings, trim, and chrome parts for looseness, proper alignment, and cleanliness.
- b. Clean off any residue.

8. **Confirm GLOVEBOX ITEMS are complete.**

Confirm the Owner's Manual and other owner booklets shipped with the vehicle (e.g., maintenance manual, warranty statements, etc.) are placed inside the Owner's Manual Portfolio and then placed in the glove box.

NOTE: The Owner's Manual Portfolio also contains a first aid kit, pen, and tire pressure gauge.

9. **Remove SEAT AND TRIM PROTECTORS.**

- a. Carefully remove the protectors from all seats.
- b. Carefully remove all trim protectors.

10. **Latch SECOND ROW CENTER SEAT BELT.**

Due to its unique arrangement, latch the center seat belt for the second row seat, showing the retail customer the proper configuration (refer to TIN-13-52A-001 for details).

11. **Check HEADLINER AND SUN VISOR CLEANLINESS.**

If stains or soil are found on the headliner or sun visors:

- a. Clean with a mild soap solution or reliable vinyl cleaner.
- b. Apply a small amount of solution with a clean cloth or sponge, then wipe with a damp cloth.
- c. After removing the lather, wipe again with a soft, clean cloth.

12. **Check for STAINS, DIRT, SCUFFS, OR TEARS.**

If the interior trim is scuffed, stained or soiled, clean as described in "Detailing After PDI," step 11.

NOTE: Damage and/or stains which cannot be removed using the described method should be noted on the repair order.

13. **Remove PAPER MATS, FOOT PEDAL PLASTIC PROTECTORS, VACUUM ALL FLOOR CARPETS, INSTALL AND ANCHOR ALL FLOOR MATS.**

- a. Remove all paper floor mats and plastic pedal protectors (if equipped).
- b. Vacuum all floor carpets.
- c. Install and anchor floor mats for all seating positions. Do not install more than one floor mat in the driver's position. Refer to TSB-12-00-009 for additional information.

14. **Confirm VEHICLE INSTALLED ACCESSORY WEIGHT.**

Refer to TSB-19-00-008 for details. Complete and attach a "Load Carrying Capacity Reduced" label if applicable.

15. **Check tire pressures and adjust if necessary. Reinstall valve stem caps.**

NOTE: Tire pressures are listed on the Tire Pressure and Loading label on the driver's side B-pillar.

16. **Confirm clock is set and audio system presets are set to local stations.**

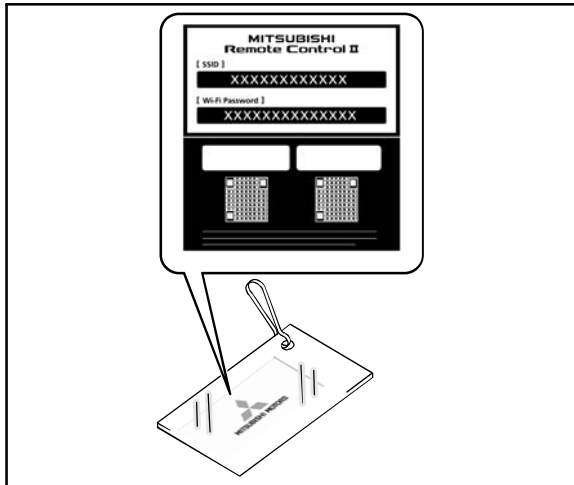

17. **Remote Control registration card.**

Confirm the remote control registration card with WiFi information is securely attached to F.A.S.T. Key.

This card contains necessary ID and password information for the customer to register the smartphone Remote Control app. **Be sure customer is given this card at final delivery.**

18. **Set up Wi-Fi EV Remote / Smartphone Remote Control App.**

On the customer's personal smartphone or tablet, install the Wi-Fi EV Remote Control App.

- For more details, go to the following website:
http://www.mitsubishi-motors.com/en/products/outlander_phev2/app/remote/
- For vehicles sold in the U.S., use software version PHEV II, available from the Apple App Store and Google Play.
- Confirm versions for i-Phone (iOS 7.0 or later) or Android (OS 4.4 or later).
- Confirm all functions can be controlled remotely (e.g., preheat/cool interior, set charge times, customize vehicle settings).

19. Check Drive Battery Production Month, Perform Procedures if Older than 3 Months.

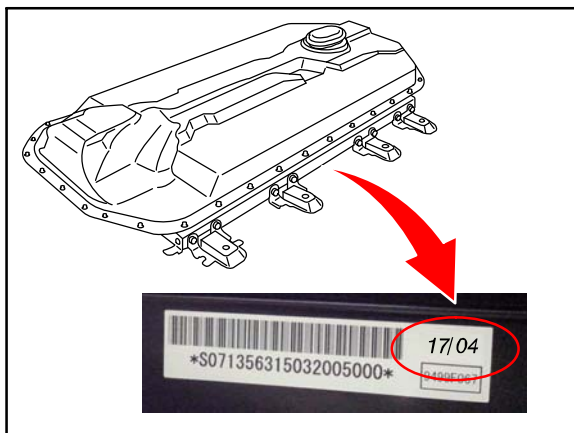

Locate the label on the drive battery, and find the production date in upper right corner.

If battery is older than 3 months (as shown in the example on the left, where production month is April, 2017) the following procedures **MUST** be performed before final delivery to the customer:

- **Manually Write BMU Learning Value**
Refer to Service Manual, Group 00 / Precautions Before Service / Procedures for Writing BMU Learning Value / BMU Learning Value Manual Written.
- **Drive Battery Capacity Automatic Measurement**
Refer to Service Manual, Group 54D / Electric Motor Unit and Drive Battery / Battery Management Unit (BMU) and Traction Battery / On-Vehicle Service / Drive Battery Capacity Automatic Measurement.

20. **Charge main drive lithium-ion battery to 100% before final delivery to customer.**

21. **Recheck the Warranty Superscreen to confirm all recall procedures have been performed.**

!! IMPORTANT !! Unless required to complete an electrical check, always make sure the **POWER** switch is in the **LOCK (OFF)** position and remove the **FAST** key from the vehicle.



COMPLETING THE PDI FORM

When finished, make sure both the PDI Technician and the Detail Specialist have signed the PDI form. Leave the yellow (2nd copy) in the vehicle's glove box. Keep the original copy with the vehicle's service file. A sample of the PDI form appears at the end of this bulletin.



PARTS INFORMATION

The table below lists Genuine Mitsubishi fluids which may be required during PDI:

Description	Part Number
DiaQueen Super Long Life Coolant Premium (or equivalent)	MZ320125
Brake Fluid (DOT3 or DOT4)	MZ311987
Washer Fluid (concentrate)	ACH3ZC1X07
Automatic Transmission Fluid SP III	MZ320200
CVT Fluid J4 (for oil cooler)	MZ320185
Engine Oil 0W-20 Synthetic (or equivalent)	MZ320934
Prop 65 Label (California dealers ONLY)*	PROP65WL

* Only order if needed. An initial supply was shipped to California dealers the week of August 20, 2018.

NOTE: Fluid additions or reductions are included as part of the PDI reimbursement labor times.



WARRANTY INFORMATION

Only one PDI procedure will be reimbursed per vehicle. In regards to dealer trades of vehicles, the first PDI procedure claim entered and paid will be the only PDI claim allowed.

The PDI procedures described in this bulletin, as well as any fluids or shop supplies required during the PDI process, are reimbursed under a single PDI labor time allowance. Each MMNA model has an assigned PDI labor time allowance. PDI labor time allowances by model and model year are provided in a separate Warranty Bulletin. Warranty Bulletins by model year may be found on the MDL , under Service > Warranty Central > Warranty Bulletins. For 2020 Outlander PHEV, refer to WB 2020-001.

NOTE: Any additional repairs and/or needed adjustments due to issues with materials and/or workmanship that are not part of these PDI procedures should be claimed on a separate warranty claim (W) using applicable published LOTS labor times and operation numbers. Use the nearest applicable LOTS operation number as a "zero-zero" actual time operation for non-published repairs and/or adjustments.



