



SERVICE BULLETIN

Classification:	Reference:	Date:
AT19-013	NTB19-076	October 8, 2019

2018 ALTIMA AND ROGUE; DTC P17F0, P17F1, P0776, P2813, P1715, AND/OR P0841 STORED

APPLIED VEHICLES: 2018 Altima (L33)
2018 Rogue (T32)

APPLIED ENGINE: QR25DE (4 cylinder only)

IF YOU CONFIRM

One or more of the following DTCs are stored:

P0776, P2813, P0841, P17F0, P17F1, P1715

HINT:

- If DTCs other than those listed above are stored, this bulletin **does not apply**.
- If the customer states the engine stalled while going from 'P' or 'N' range to 'R' or 'D' range, this bulletin **does not apply**.
- If DTC P17F0 and/or P17F1 are the only DTCs stored and there is no customer complaint of judder, this bulletin **does not apply**.
- If DTC P1715 is the only code stored, this bulletin **does not apply**.

ACTION

See Repair Flow Chart on page 2 to confirm if this bulletin applies.

HINT: The following pages must be printed and attached to the RO:

1. Clutch Total End Play Calculation (Step 97 on page 63)
2. Consult screen shot showing the TCM part numbers (Step 152 on page 89)
3. Current Calibration Data (Step 155 on page 90)
4. New Calibration Data (Step 171 on page 91)
5. Parts Kit Reference Table (Page 99)

IMPORTANT: The purpose of ACTION (above) is to give you a quick idea of the work you will be performing. You **MUST** closely follow the entire SERVICE PROCEDURE as it contains information that is essential to successfully completing this repair.

Nissan Bulletins are intended for use by qualified technicians, not 'do-it-yourselfers'. Qualified technicians are properly trained individuals who have the equipment, tools, safety instruction, and know-how to do a job properly and safely. **NOTE:** If you believe that a described condition may apply to a particular vehicle, DO NOT assume that it does. See your Nissan dealer to determine if this applies to your vehicle.

Repair Flow Chart

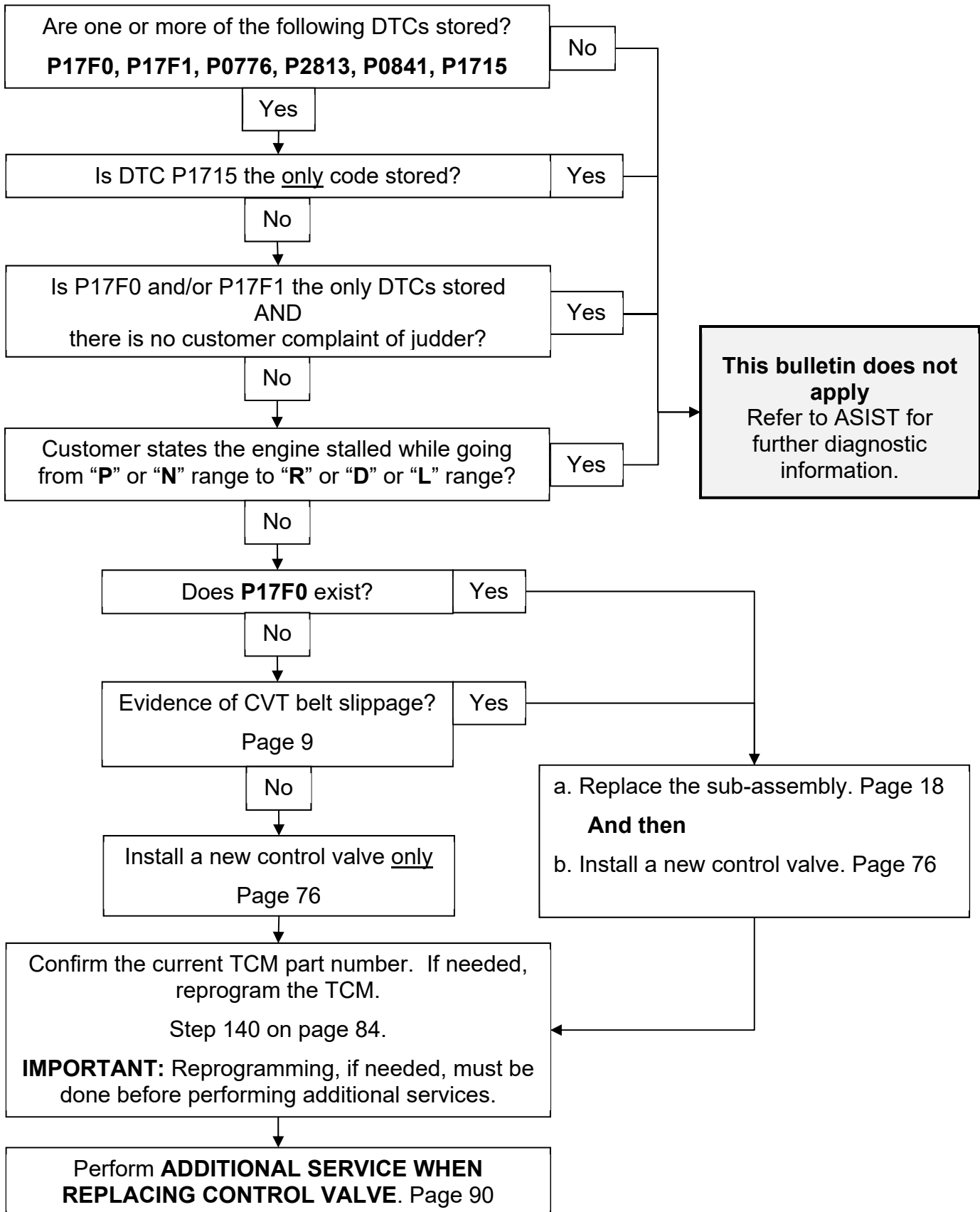

Table of Contents

• Required Tools / Material.....	page 4
• Essential Tools.....	page 4
• Weights.....	page 6
• Precautions when Disassembling a CVT Assembly.....	page 7
• Control Valve Removal and CVT Belt Inspection.....	page 9
• CVT Assembly Removal.....	page 18
• Remove the Converter Housing, Oil Seals, Oil Pump Cover, Oil Pump and Oil Filter.....	page 21
• Clean the CVT case surfaces.....	page 29
• Clean the Oil Passages in the CVT Case, Oil Pump Cover, and CVT Filter Area.....	page 30
• New Oil Pump Installation.....	page 32
• Replace the Side Cover – Pulleys and Belt (sub-assembly).....	page 34
• Clutch Total Endplay Adjustment – Thrust Bearing Selection.....	page 60
• Clean the Converter Housing Passages.....	page 66
• CVT Reassembly.....	page 68
• Control Valve Strainer and Pan Installation.....	page 76
• Install the CVT Assembly.....	page 82
• TCM Reprogramming.....	page 83
• ADDITIONAL SERVICE WHEN REPLACING CONTROL VALVE.....	page 90
• PARTS INFORMATION.....	page 95
• CLAIMS INFORMATION.....	page 97
• PARTS KITS REFERENCE TABLE.....	page 99

Required Tools / Materials

- Cherry picker / engine hoist / lifting arm (never handle replacement CVT sub-assembly by hand)
- Strap or chain to lift and lower CVT and sub-assembly
- Petroleum jelly or equivalent
- Extendable magnet
- Large clean surface / 1 to 2 work tables
- Vernier calipers
- Brake cleaner or equivalent solvent
- 90% Isopropyl alcohol
- Lens swab
- Plastic scraper

Essential Tools

Additional Essential Tools are available from Tech•Mate online: www.nissantechmate.com, or by phone: 1-800-662-2001.

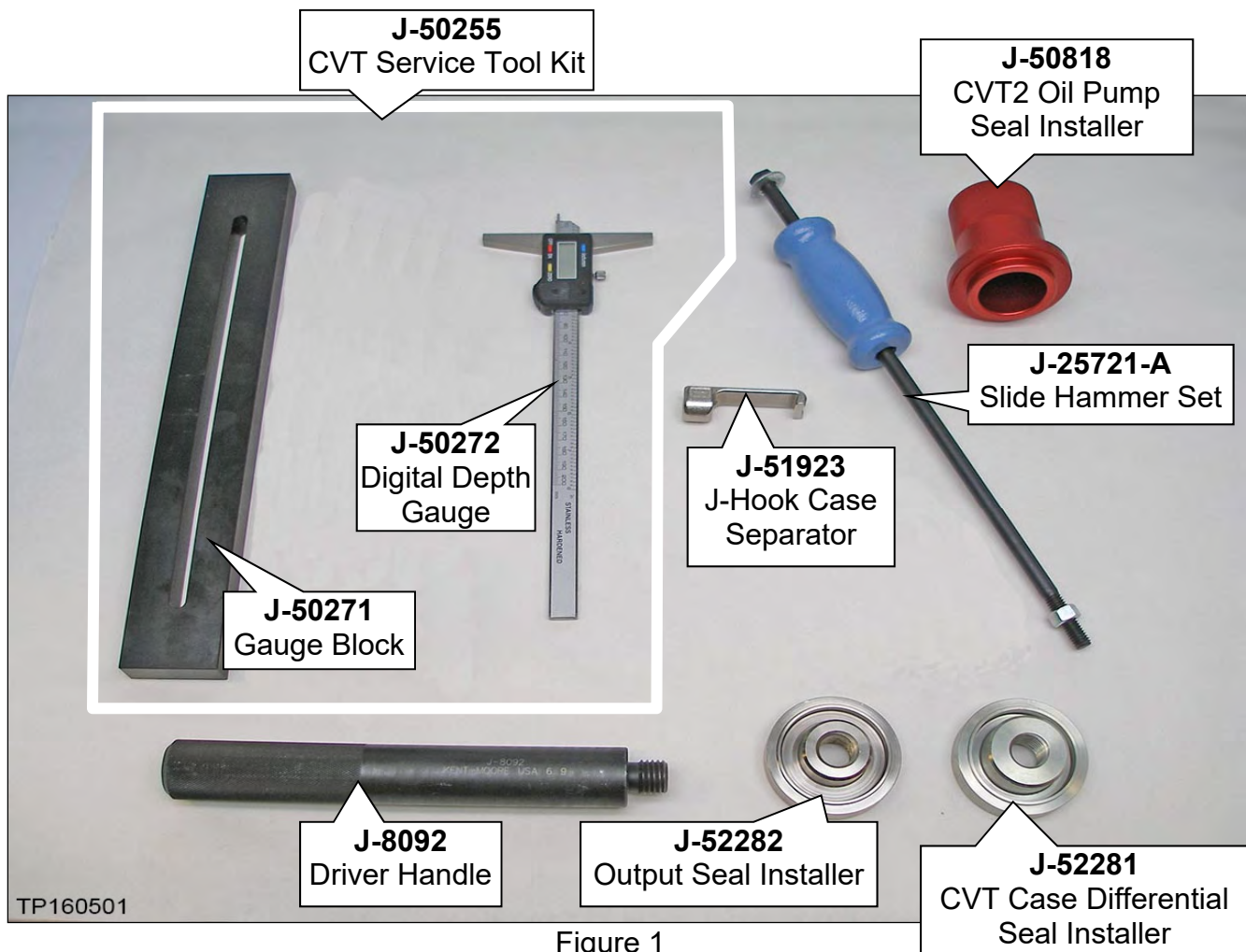

Figure 1

Essential Tools (continued)



Figure 2

CAUTION

To avoid personal injury or vehicle damage, always handle the CVT and component assemblies carefully and with the appropriate lifting tools.

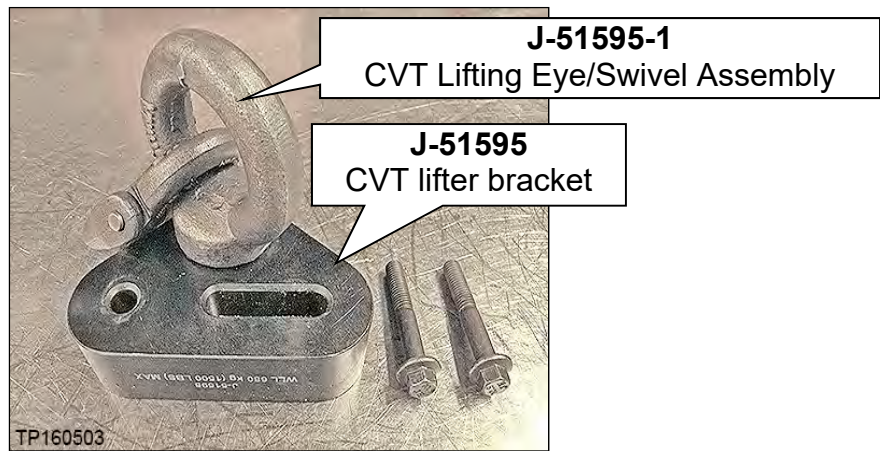
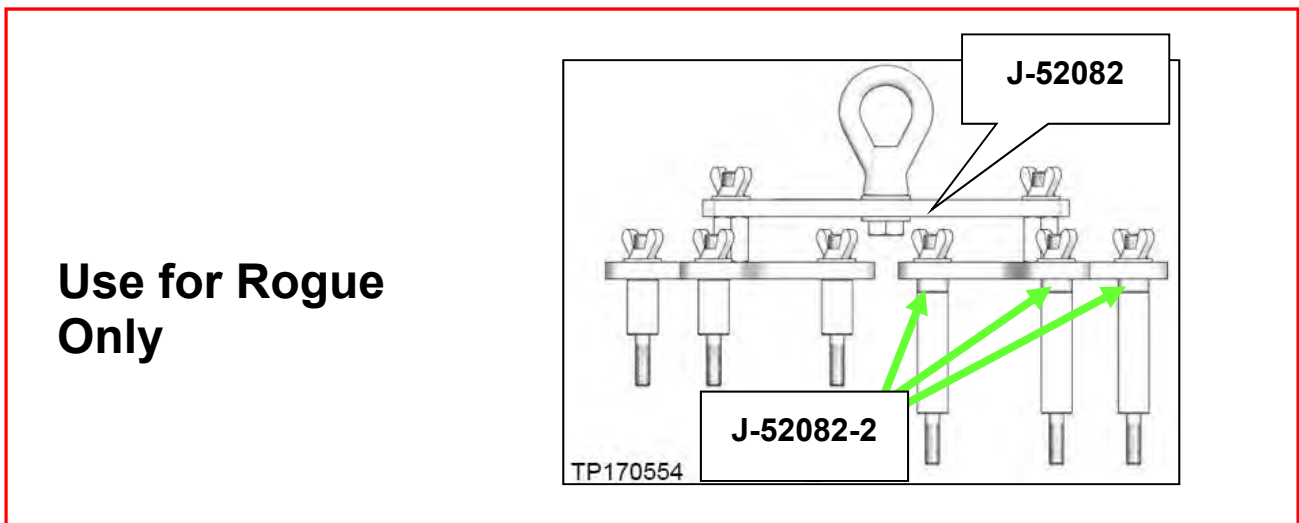

Figure 3



Use for Rogue Only

Figure 4

Essential Tools (continued)

CAUTION

To avoid personal injury or vehicle damage, always handle the CVT and component assemblies carefully and with the appropriate lifting tools.

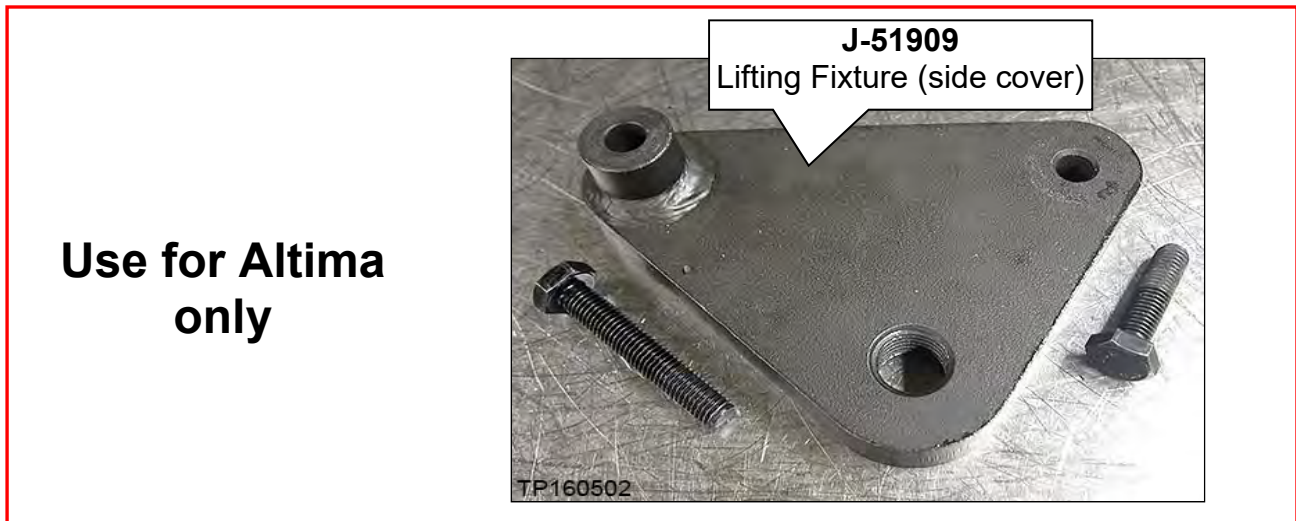

Figure 5

Tech Cam J-51951

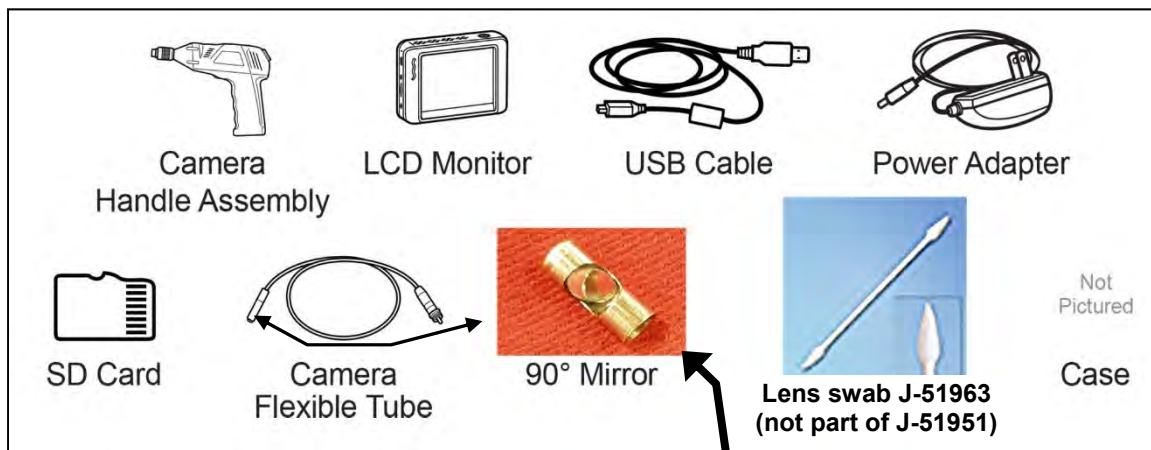

Figure 6

Remove protective film before first use

- Additional Tech Cam J-51951 kits or components are available from Tech•Mate.

Weights

- CVT assembly: 300 lbs. approximately
- CVT sub-assembly: 65 lbs. approximately

SERVICE PROCEDURE

IMPORTANT: Repairs performed for this bulletin require CONSULT-III plus Diagnostic result reporting function-Setting to be ON and Diagnosis (All Systems) to be performed. If not done, it may result in a repair being non-warrantable.

Precautions when Disassembling a CVT Assembly

Transmissions are vulnerable to particles (dust, metal, lint, etc.).

When disassembling a CVT, make sure your work environment (shop, workbench, etc.), transmission area (sub-frame, oil pan, harness connector, etc.), and your hands are free of contamination.

NOTICE

To avoid damage to the CVT.

- Wash and clean the exterior of the CVT assembly prior to disassembling to prevent debris and contamination from entering.
- Cover all air breather and drive shaft holes to prevent water intrusion.
- Make sure all parts are clean prior to assembling / installing to prevent debris and contamination from entering.

HINT:

- Refrigerating oil seals may help in assembly (axle and T/C seals).
 - Unpack service parts just before installation.
 - Apply rust penetrant to locator / dowel pins on the torque converter housing and side cover of the CVT and allow to soak to help with disassembly.
 - Store the related parts that have been removed separately to prevent being mixed up; small cups can be used.
- Unpack service parts just before installation.

- Store the related parts that have been removed separately to prevent being mixed up; small cups can be used.

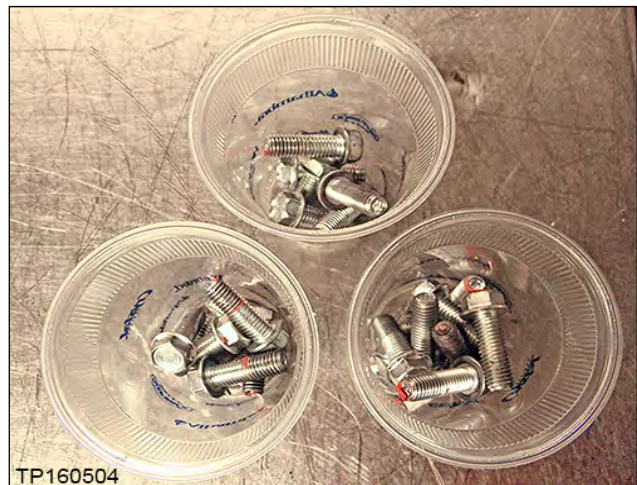

Figure 7

HINT: The CVT unit wiring harness connector will be reused during this procedure. The wiring harness can be disconnected from the control valve at the wiring harness connector and remain in the CVT.

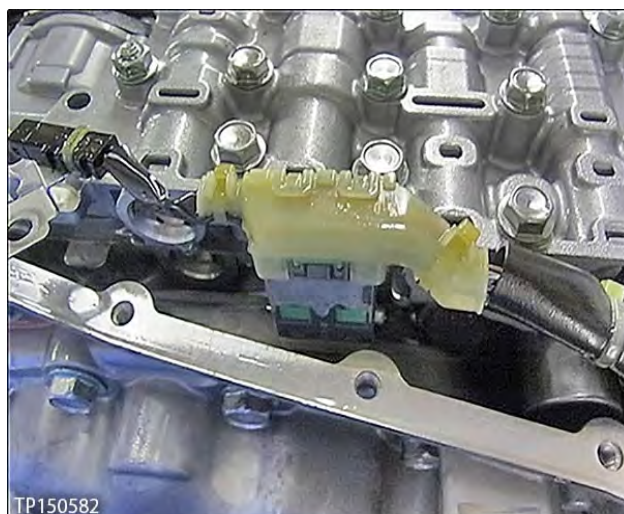

Figure 8

Control Valve Removal and CVT Belt Inspection

1. Write down all radio station presets.

Presets	1	2	3	4	5	6
AM						
FM 1						
FM 2						
SAT 1						
SAT 2/3						
Bass	Treble		Balance	Fade	Speed Sen. Vol.	

2. Disconnect both battery cables, negative cable first.
3. Remove the control valve.
 - Place the transmission gear selector in Neutral before lifting the vehicle.
 - For control valve removal, refer to the ESM: section **TRANSMISSION & DRIVELINE - TRANSAXLE & TRANSMISSION - CVT: RE0F10D - REMOVAL AND INSTALLATION - CONTROL VALVE**.

HINT: The number '7' is on the head of all bolts that need to be removed for control valve removal. Do not remove any bolt that does not have the number '7'.

NOTICE

To prevent damage to the CVT, never allow any chemicals or fluids other than NS-3 CVT fluid or equivalent to enter the CVT assembly. Never allow any foreign debris, dust, dirt, etc. to enter the CVT assembly.

- For additional information, see video # 544: "CVT Belt Inspection". This video is located under the TECH TRAINING GARAGE VIDEOS tab in Virtual Academy.

Exploded View

SEC. 311•317

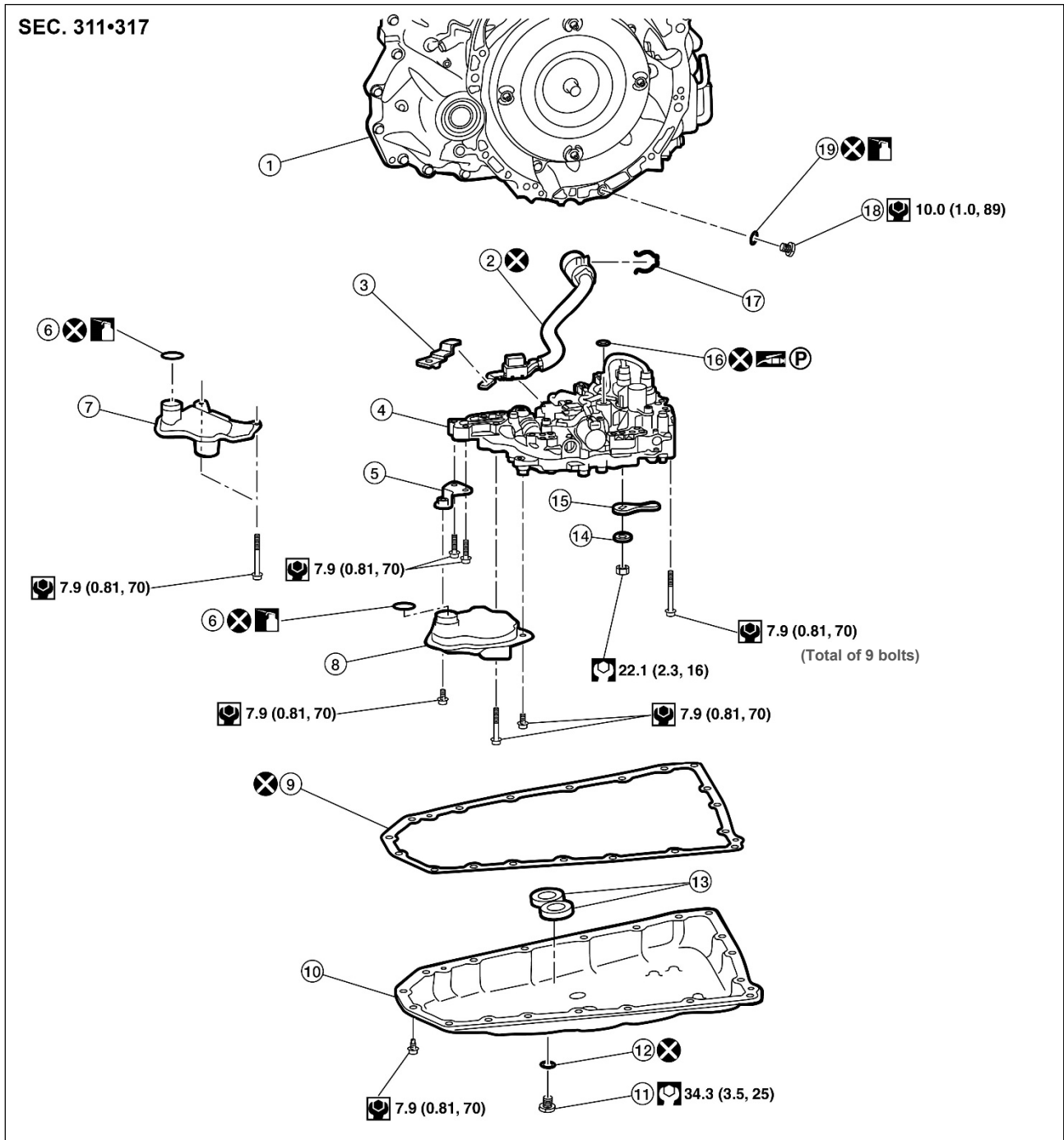

Figure 9

- | | | |
|----------------------|--------------------------|-------------------------|
| ① Transaxle assembly | ② Terminal cord assembly | ③ Control valve |
| ④ Bracket | ⑤ O-ring | ⑥ Oil strainer assembly |
| ⑦ Oil pan gasket | ⑧ Oil pan | ⑨ Drain plug |
| ⑩ Drain plug gasket | ⑪ Magnet | ⑫ Spring washer |
| ⑬ Manual plate | ⑭ Lip seal | ⑮ Snap ring |
| ⑯ Overflow plug | ⑰ O-ring | |

⊗ : Always replace after every disassembly.

⊕ : N·m (kg-m, ft-lb)

⊖ : N·m (kg-m, in-lb)

4. Secure the front right tire with a suitable strap, so that it cannot rotate.
 - This will assist in making the belt turn.
5. Mark the front left tire with a suitable marking.
 - This will assure all 360° of the belt are inspected.



Figure 10

6. Using borescope J-51951 with its mirror attachment, insert the camera lens between the CVT case and pulley where shown in Figure 11 and Figure 12.
 - Insert the lens approximately seven (7) inches, and then view the side of the belt that contacts the pulley.

HINT:

- Clean the camera lens and mirror before each inspection. Use 90% isopropyl alcohol and a lens swab from Lens Swab packet J-51963 listed in the **PARTS INFORMATION** on page 95.
- Before inspecting, make sure the batteries in the camera handle and LCD monitor are charged.

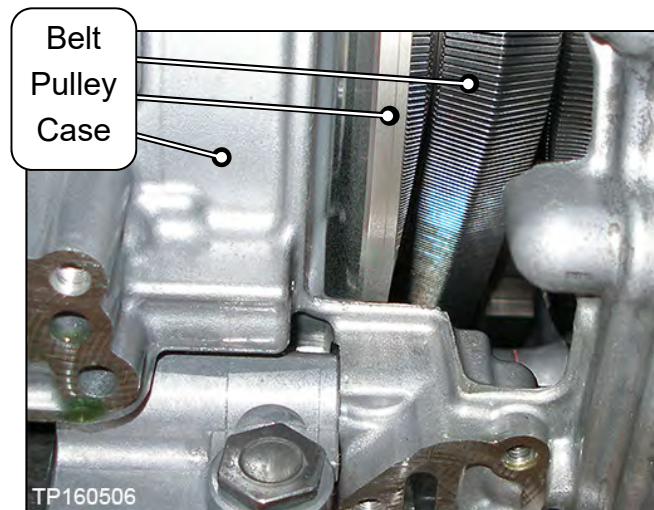

Figure 11

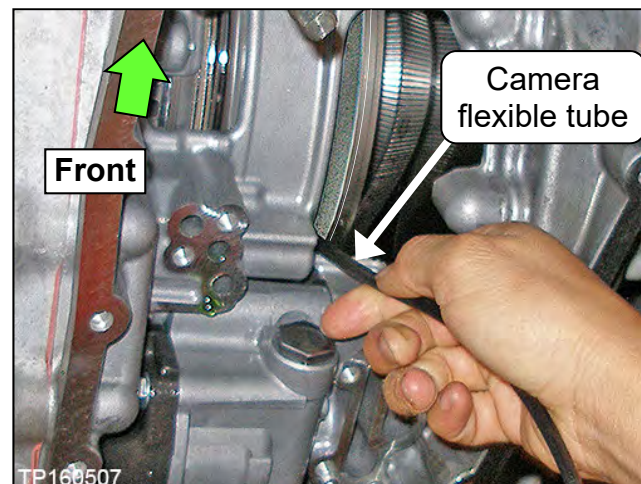

Figure 12

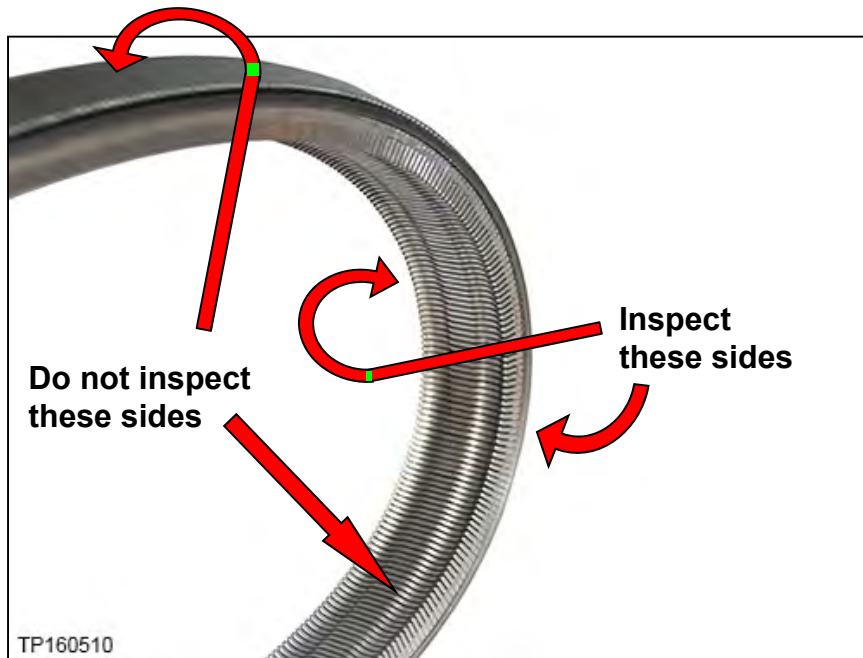

Figure 13

7. Inspect the entire side of the belt by, slowly and carefully, turning the front left tire one full rotation in the forward direction.
 - Holding the borescope with one hand allows for turning the tire with the other hand (see Figure 14).
 - Reference the Figures on pages 14 through 17 for a comparison of an **OK** and **NG** belt condition.



Figure 14

HINT: If the tire rotates in the rearward direction, the camera lens may be caught between the belt and pulley.

- If the inspection result is **OK**, inspect the other side of the belt in step 8.
- If the inspection result is **NG**, replace the CVT sub-assembly (page 18), control valve (page 76) and, if applicable, reprogram the TCM (page 83).

8. Insert the camera lens in the second location where shown in Figure 15, and then perform step 7 again.

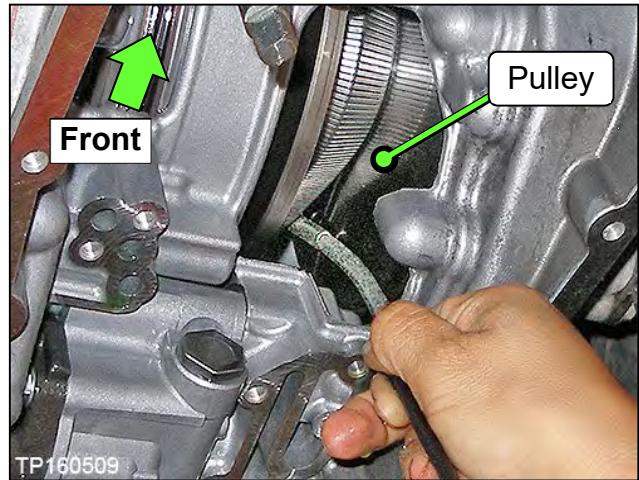
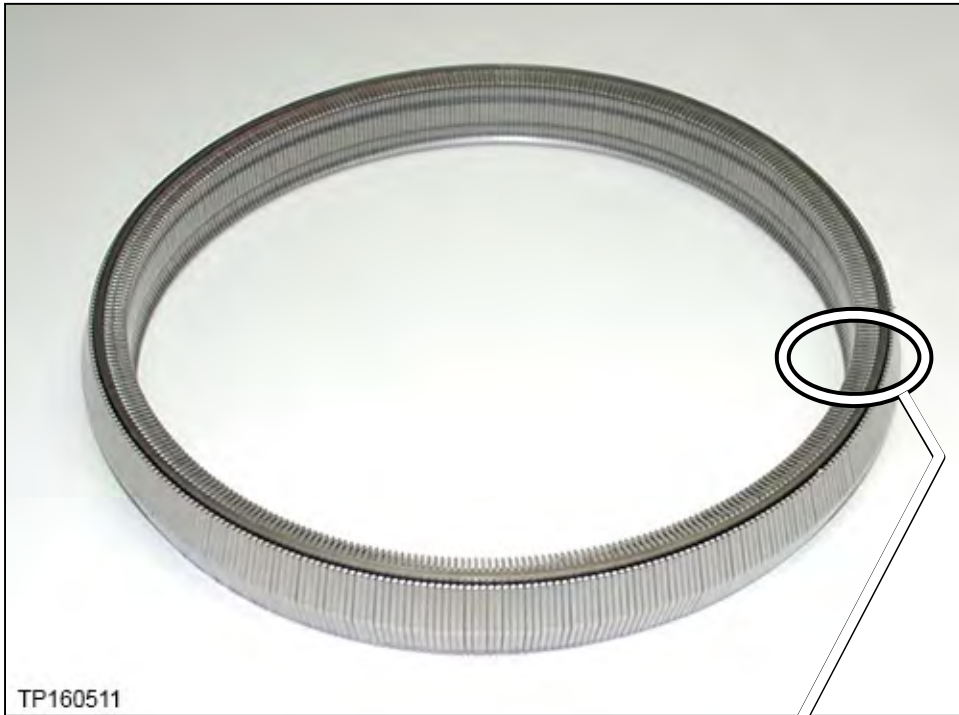

Figure 15

- If the inspection result is **OK** on both sides of the belt, replace the control valve (page 76) and, if applicable, reprogram the TCM (page 83).
- If the inspection result is **NG**, replace the CVT sub-assembly (page 18), control valve (page 76) and, if applicable, reprogram the TCM (page 83).



TP160511

Figure 16: New belt

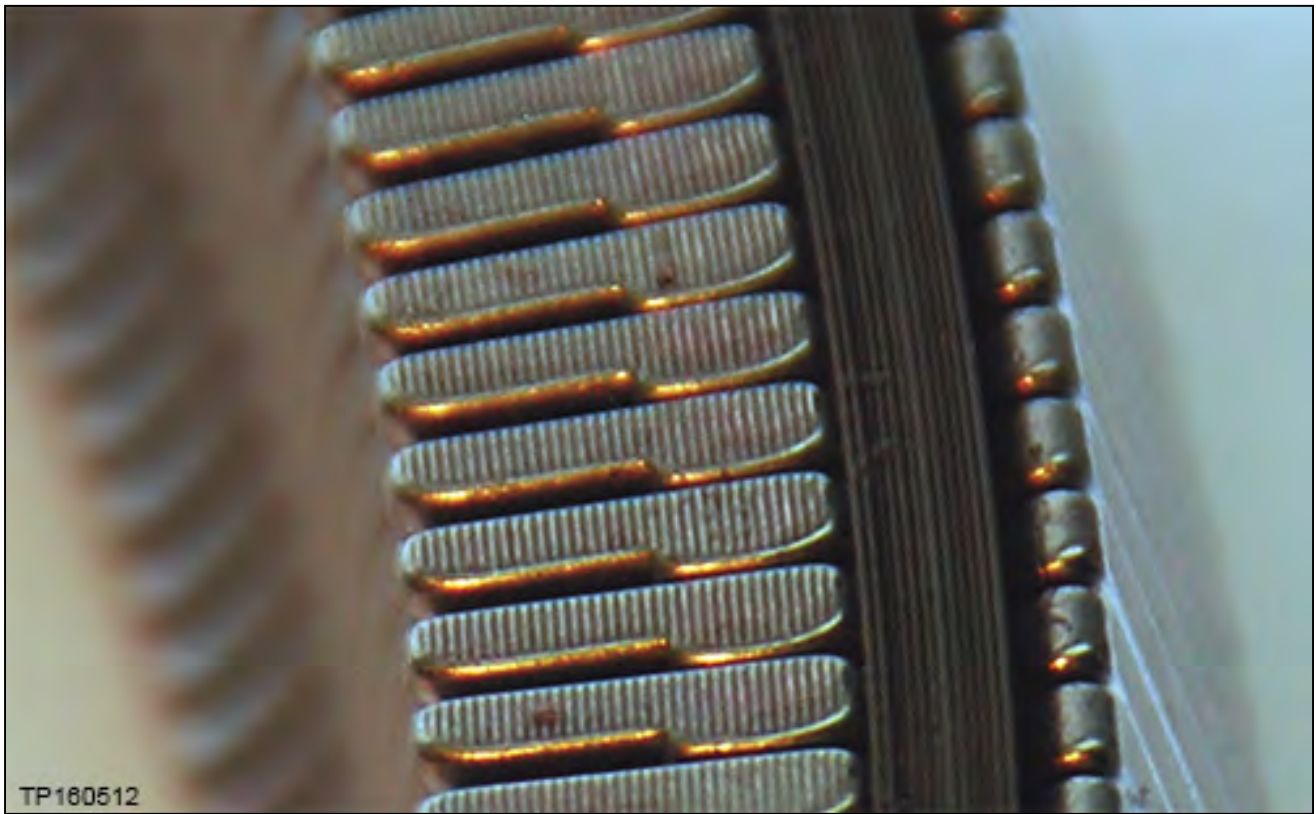

TP160512

Figure 17: Close-up of section to be inspected

Pictures in Figure 18 and Figure 19 were taken with borescope J-51951.

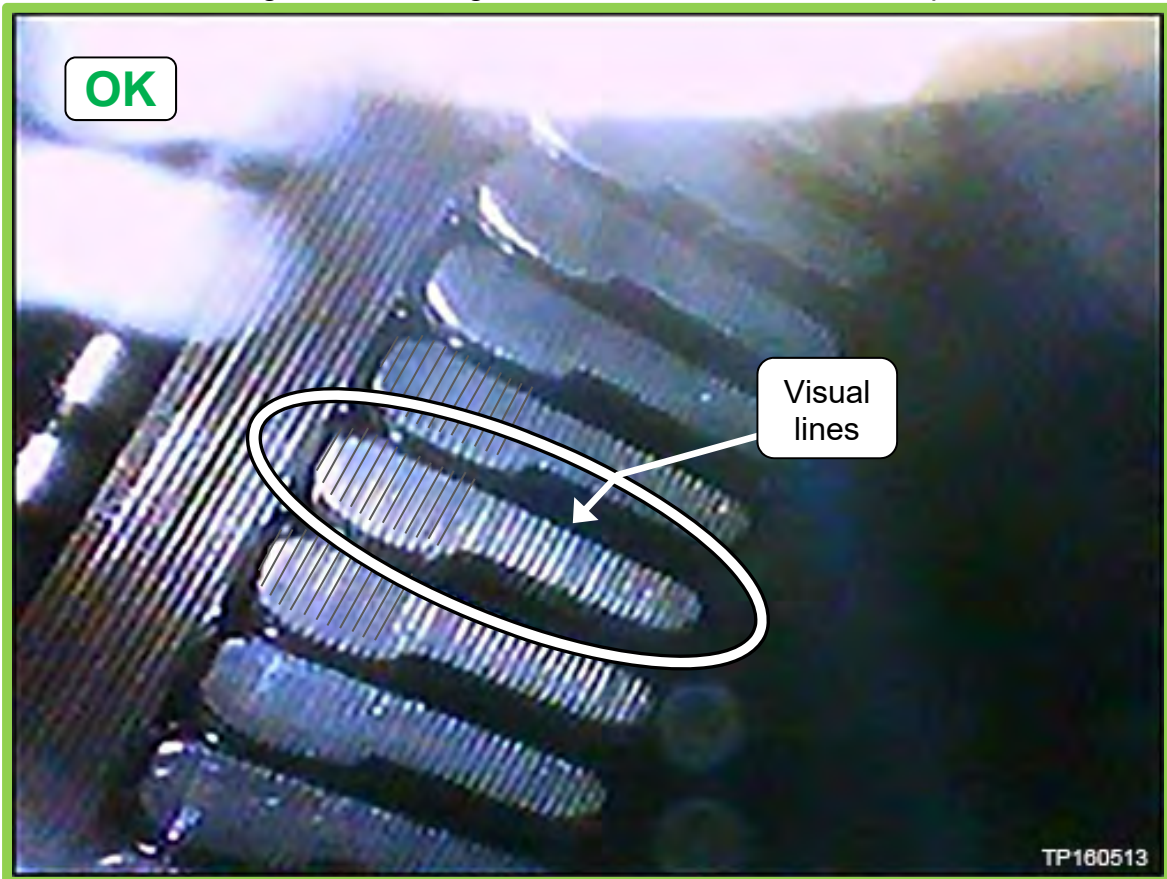

Figure 18: Belt is OK

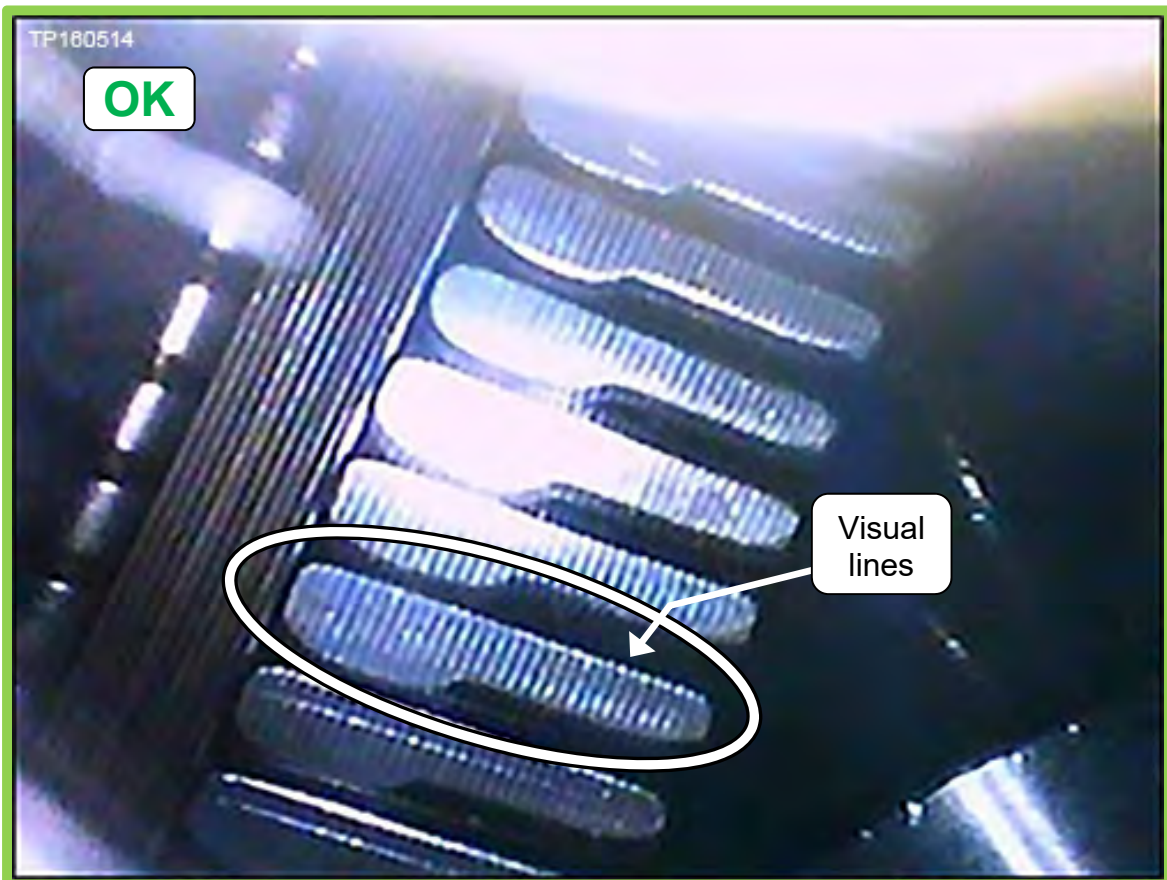

Figure 19: Belt is OK

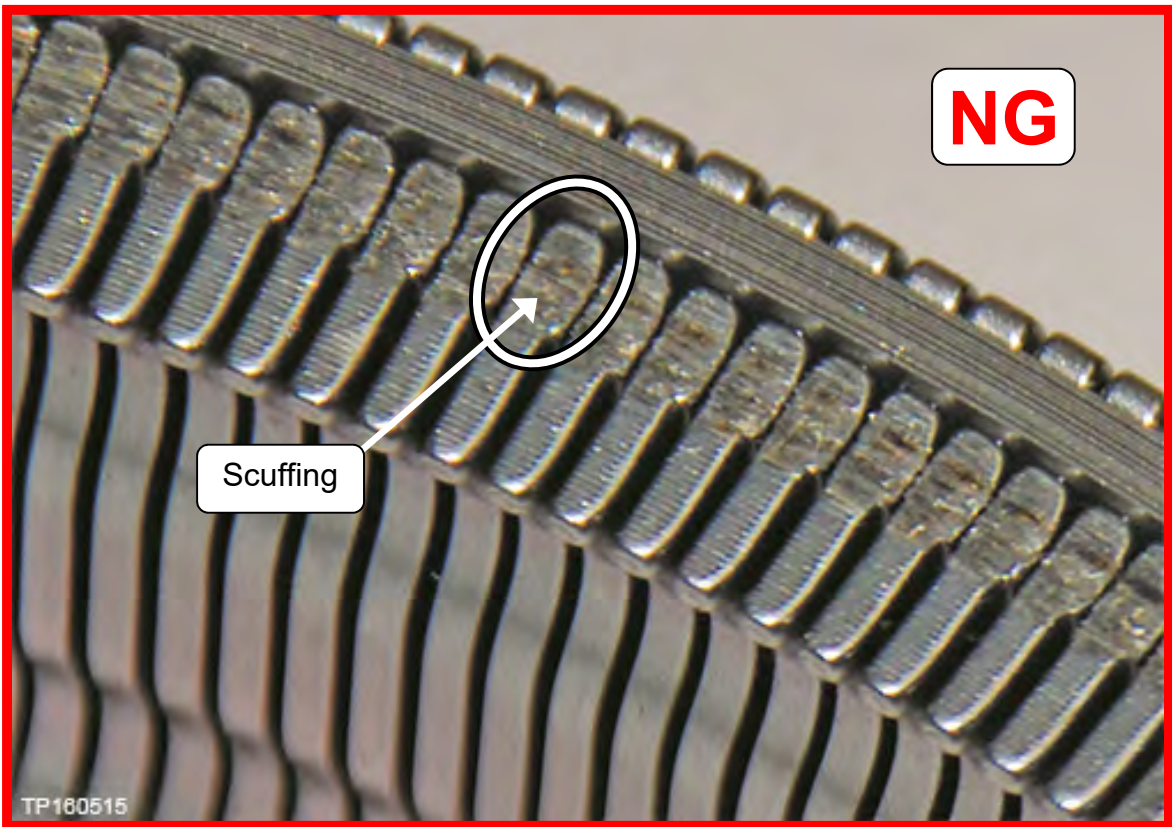

Figure 20: Example of NG belt

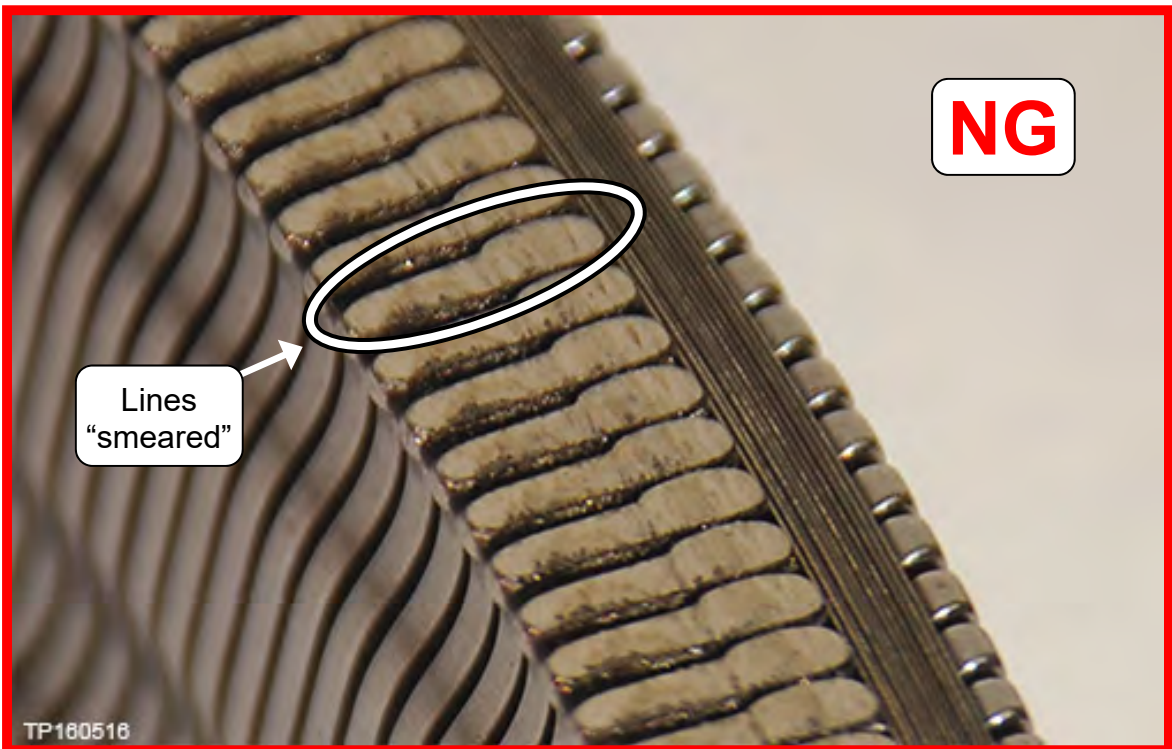

Figure 21: Example of NG belt

Pictures in Figure 22-Figure 24 were taken with borescope J-51951.



Figure 22: Example of NG belt



Figure 23: Example of NG belt



Figure 24: Example of NG belt

CVT Assembly Removal

Overview of Sub-assembly Repair

Steps 1-15 below are an overview of the CVT sub-assembly repair. The procedure for this bulletin continues on the next page with step 9.

1. Apply rust penetrant as necessary to the dowel pins on the converter housing side and sub-assembly side cover
2. Remove the CVT from the vehicle
3. Remove the Converter Housing, Oil Seals, Oil Pump Cover, Oil Pump and Oil Filter
4. Clean the CVT case surfaces
5. Clean the Oil Passages in the CVT Case, Oil Pump Cover, and CVT Filter Area
6. Check initial pulley movement characteristics
7. New Pump Installation
8. Replace the Side Cover – Pulleys and Belt
9. Confirm shift selector movement
10. Recheck new pulley movement characteristics matches that of the original assembly
11. Clutch Total Endplay Adjustment – Thrust Bearing Selection
12. Clean the Converter Housing Passages
13. CVT Reassembly
14. Control Valve Strainer and Pan Installation
15. Install the CVT Assembly

HINT: For additional information review video # 547: “CVT Belt and Pulley Replacement”.

- This video is located under the **TECH TRAINING GARAGE VIDEOS** tab in Virtual Academy.

9. Temporarily install the oil pan gasket and oil pan with four oil pan bolts at the corners of the oil pan, hand tight (Figure 25).

HINT: It is not necessary for the control valve to be installed, a new one will be installed later in the service procedure.

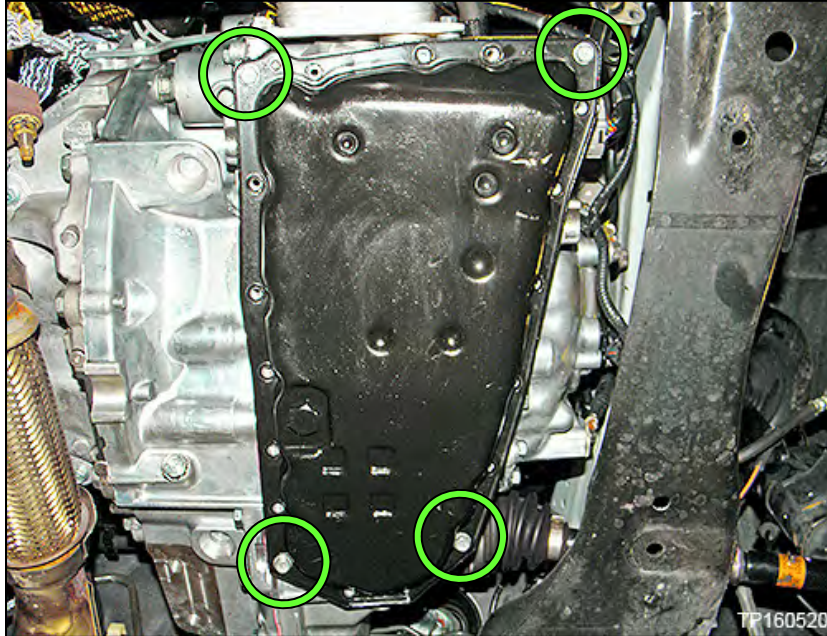

Figure 25

10. Remove the CVT from the vehicle.
 - For CVT removal, refer to the ESM: section **TRANSMISSION & DRIVELINE - TRANSAXLE & TRANSMISSION - CVT: RE0F10D - UNIT REMOVAL AND INSTALLATION - TRANSAXLE ASSEMBLY.**

NOTICE

To avoid seal damage or deformation on AWD vehicles, use extreme care when moving the axle in or out of the transfer case assembly. Properly support and guide the axle.

11. Place the CVT on a workbench with the oil pan side down.

NOTICE

Use wood or plastic blocks to keep the CVT steady and prevent deformation to the oil pan.

12. Remove the torque converter.

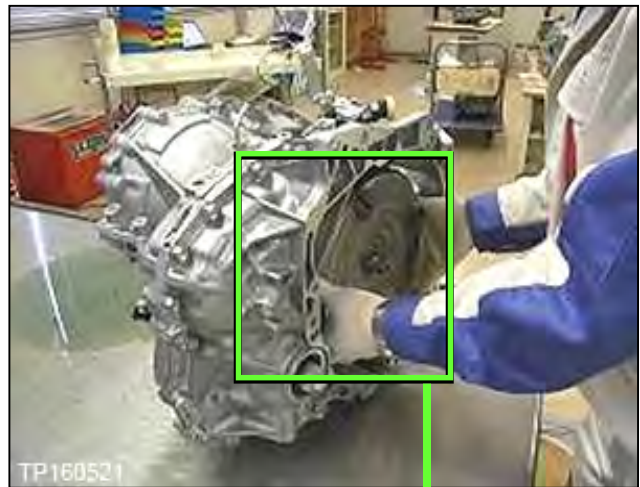

Figure 26

13. Drain the torque converter.



Figure 27

14. Remove the primary speed sensor.

HINT: The speed sensor will be reused.

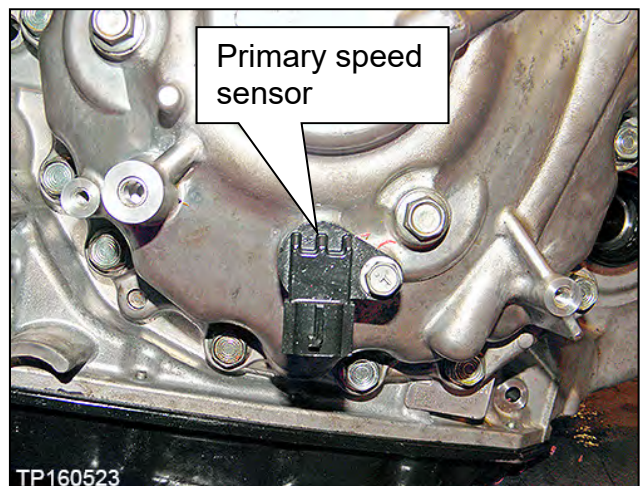



Figure 28

Remove the Converter Housing, Oil Seals, Oil Pump Cover, Oil Pump and Oil Filter

15. Remove all 23 converter housing mounting bolts (see Figure 29).

HINT:

- These bolts will be replaced with new ones and will not be reused.
- Use a short socket on the bolts indicated by 
- Apply rust penetrant to the dowel pins if needed.

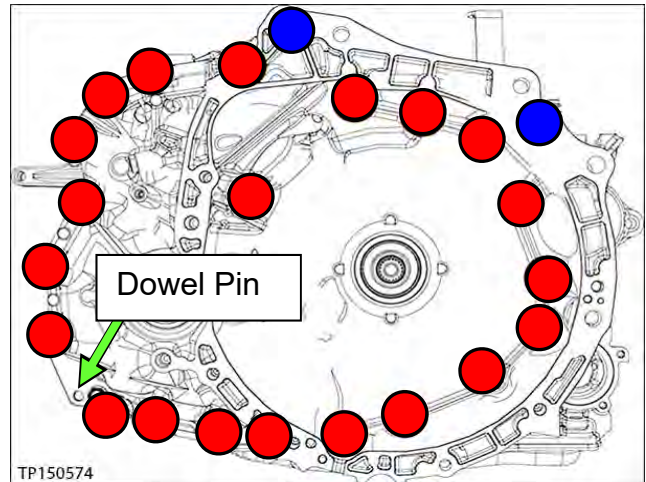

Figure 29

16. Separate and then remove the converter housing from the CVT case.

- Use Slide Hammer J-25721-A and Slide Hammer Bolt J-50255-UPD with J-Hook J-51923 at the cut-out areas similar to the one shown in Figure 30 and Figure 31.

NOTICE

To avoid damage to the vehicle **DO NOT** use a pry-bar, chisel, etc. to separate the converter housing from the CVT case.

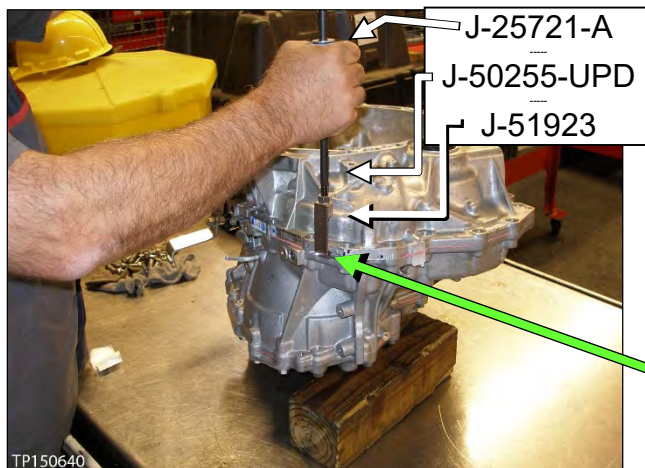

Figure 30

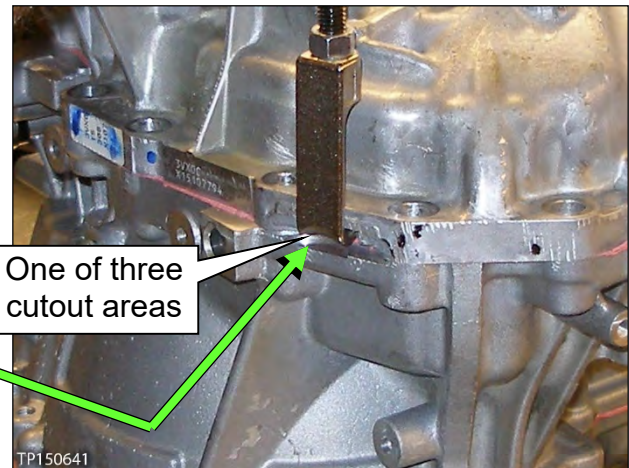

Figure 31

17. Note the location of the pin shown in Figure 32 and Figure 33.

HINT: This pin can slip out during movement of the CVT while the converter housing is removed.

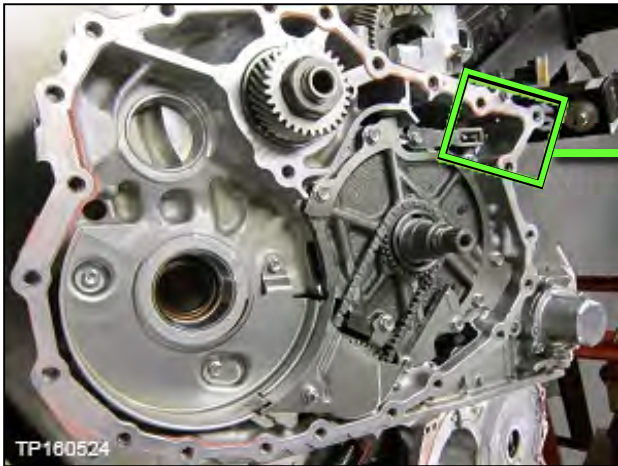

Figure 32

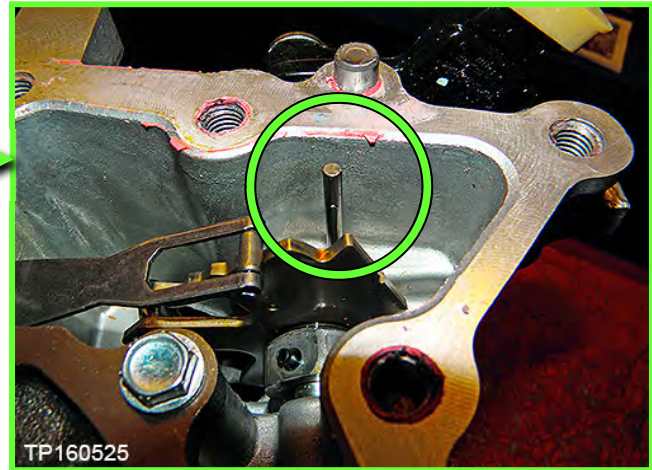

Figure 33

18. Remove the O-ring from the input shaft.

- This O-ring will be replaced with a new one.

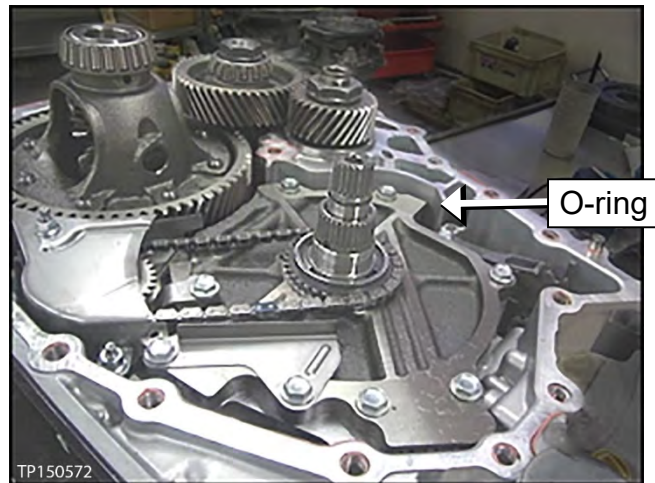

Figure 34

19. Carefully remove the reduction gear assembly (Figure 35).

20. Carefully remove the differential assembly (Figure 36).

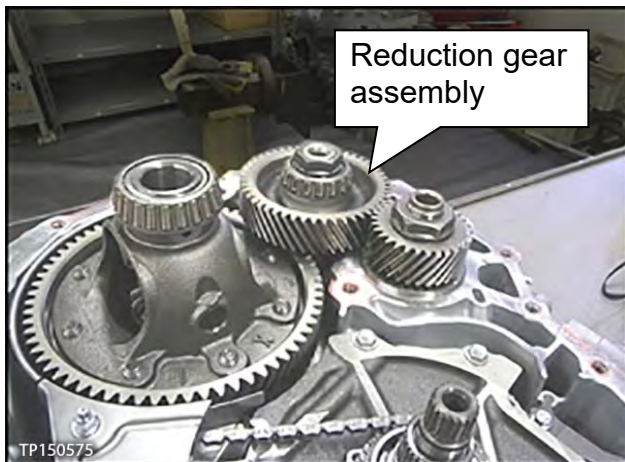

Figure 35

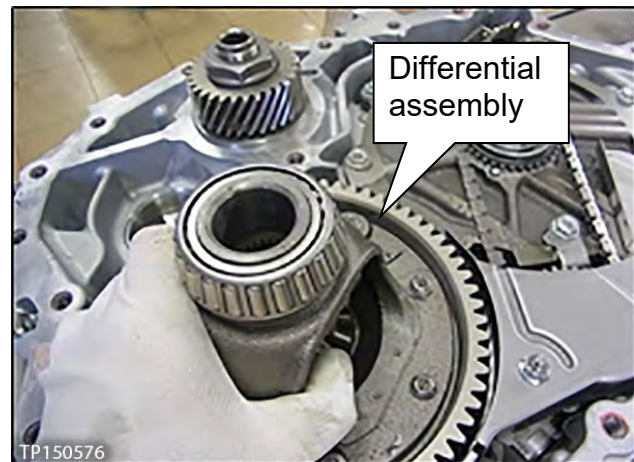

Figure 36

21. Remove the following oil seals using suitable tools:

NOTICE

Be careful not to damage any of the seal bore surfaces.

- a. CVT case differential side oil seal (drive shaft seal).
 - See Figure 37.

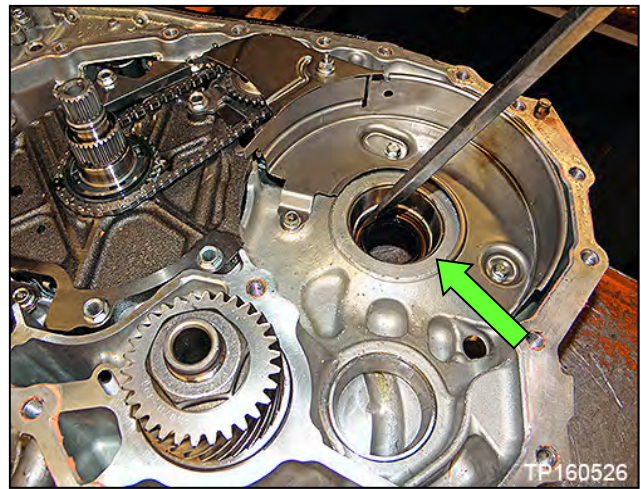

Figure 37

- b. Torque converter seal (Figure 38).

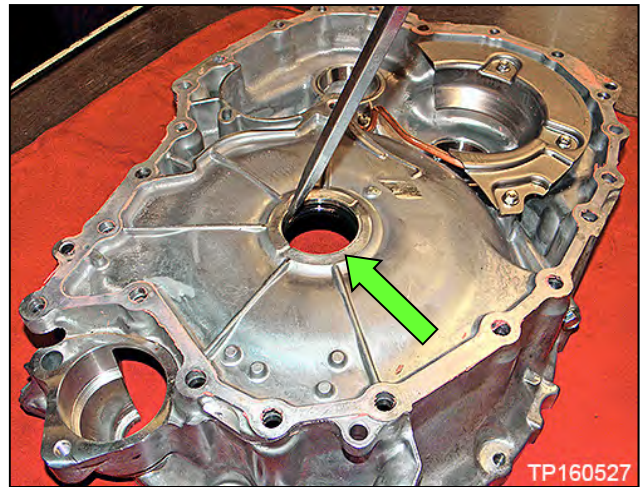

Figure 38

- c. Converter housing differential side oil seal (drive shaft seal).

- See Figure 39.

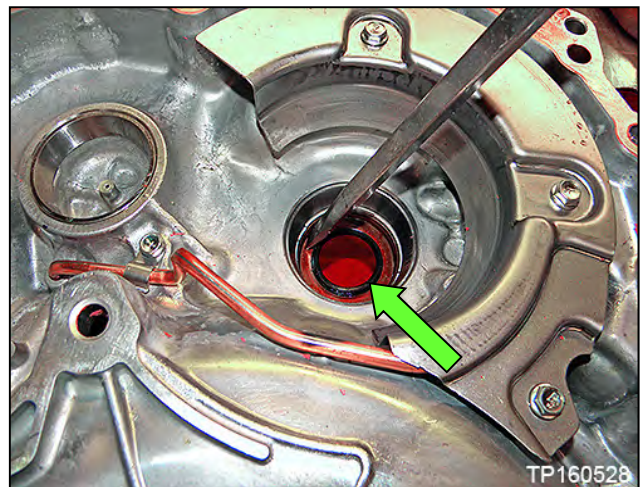

Figure 39

22. Remove the two (2) nuts from baffle plate A, and then remove baffle plate A (see Figure 40).

NOTICE

To avoid damaging the nuts, use a 6-pt 10 mm socket.

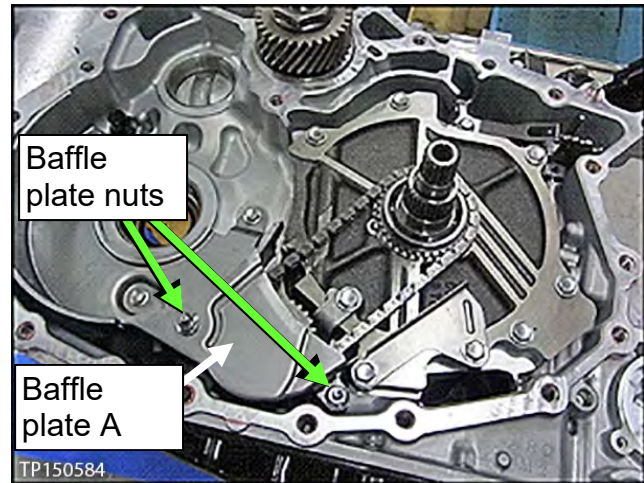

Figure 40

23. Remove the oil pump chain, driven sprocket and drive sprocket as one assembly (Figure 41).
- Spread the snap ring to remove the sprocket (Figure 42).

HINT: The drive sprocket has a specific top and bottom. Keep the sprockets and chain together after removal.

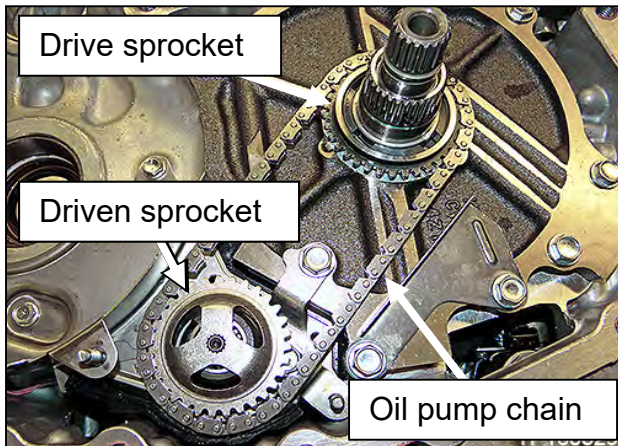

Figure 41

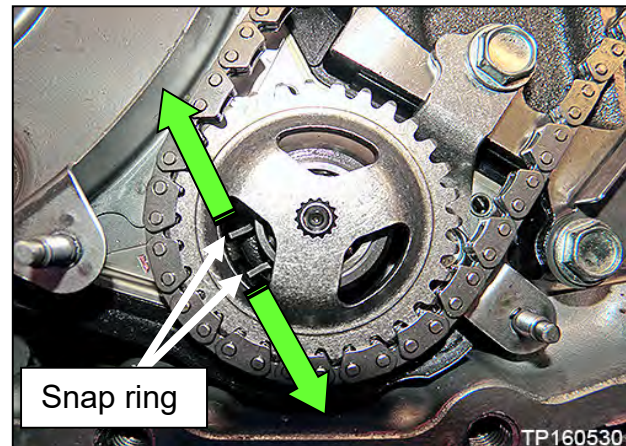

Figure 42

24. Remove the pump cover (dummy cover) thrust washer (Figure 43).
- This thrust washer will be reused.

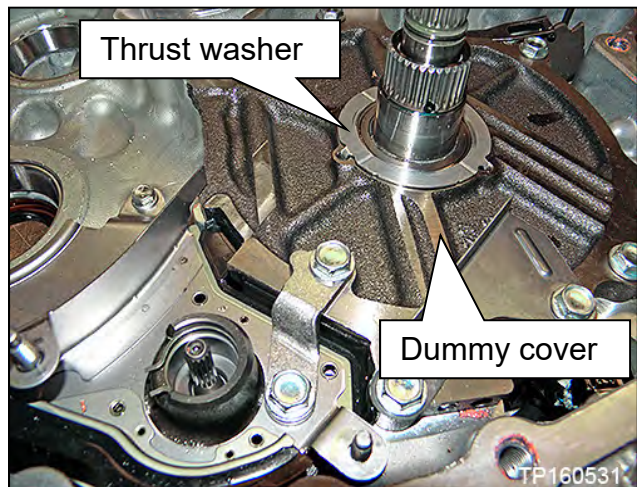

Figure 43

25. Remove the oil pump snap ring (Figure 44).
- Lightly push the ends of the snap ring together, rotate one side upwards while pulling the snap ring towards the pump opening.

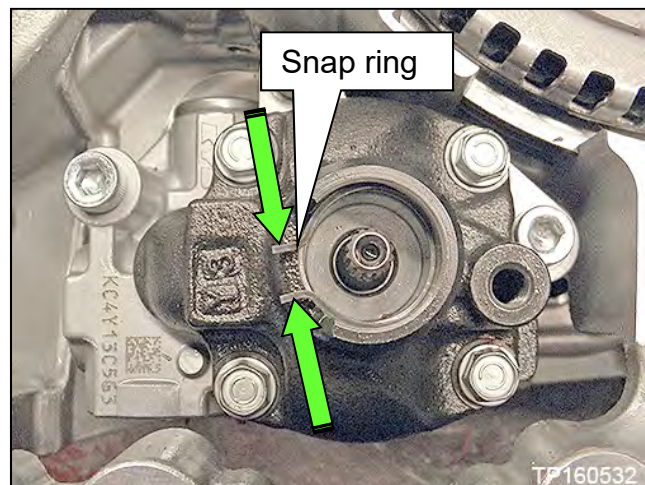

Figure 44

26. Remove the oil pump bracket (Figure 45).
- Retained by two bolts.

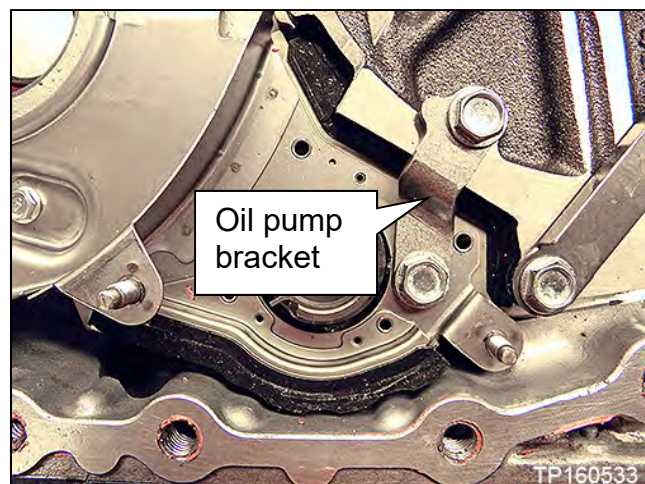

Figure 45

27. Remove the three (3) bolts from baffle plate B, and then remove baffle plate B (Figure 46).

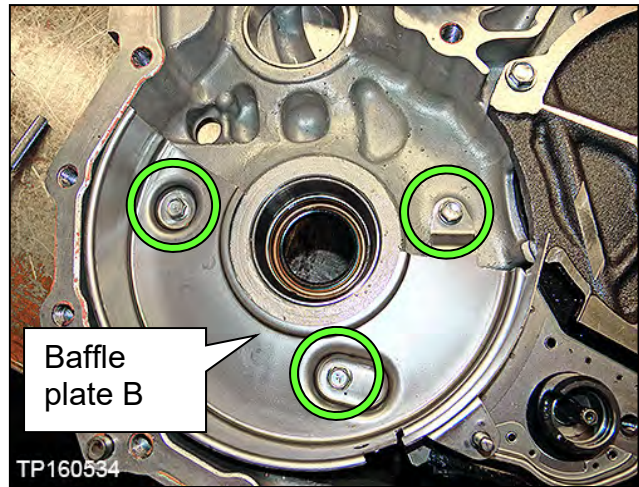

Figure 46

28. Remove the two (2) bolts from baffle plate C, and then remove baffle plate C (Figure 47).

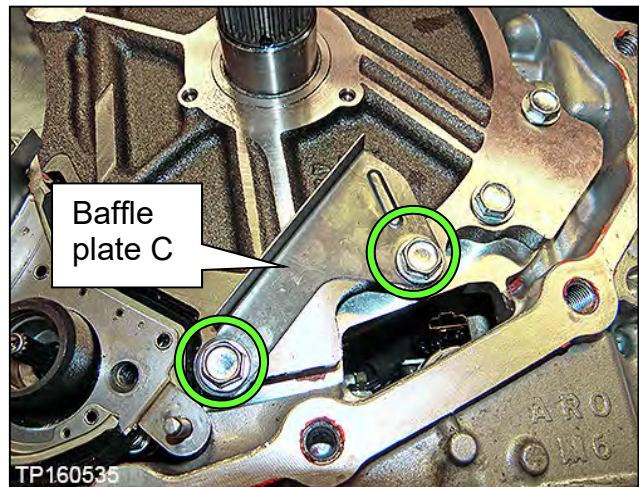

Figure 47

29. Remove the five (5) dummy cover bolts, and then remove the dummy cover. See Figure 48.

HINT:

- These bolts will be reused.
- Lift the dummy cover from sides **ONLY**. Do **NOT** lift from the input shaft (Figure 48). This can lift the clutch pack out.
- Do **NOT** remove the lathe cut seals (white seals in Figure 49) from the dummy cover. These seals will be reused.
- **Lathe cut seals must be in their correct positions during final assembly to prevent drivability issues.**

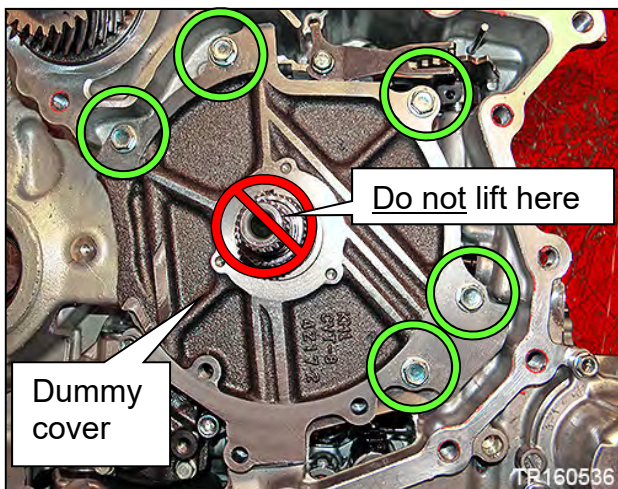

Figure 48

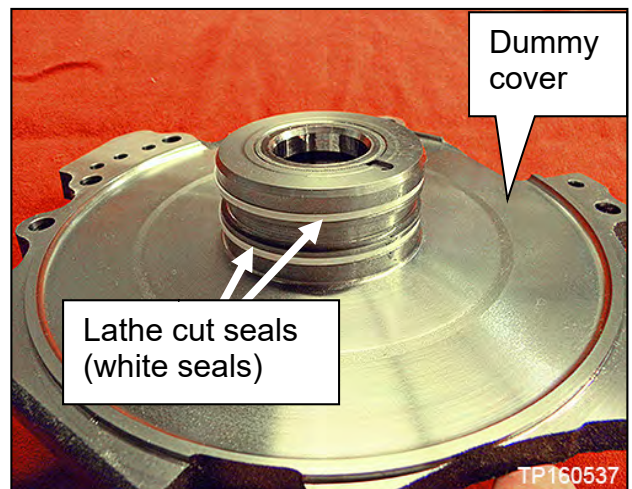

Figure 49

30. Remove the thrust bearing from the clutch assembly bore (Figure 50).

HINT:

- Take care when removing the thrust bearing so that the lathe cut seals are not knocked out of their grooves.
- The thrust bearing has two different sides. As the thrust bearing is removed, note the thrust bearing orientation so that the new bearing can be installed in the same orientation.
- This bearing will not be reused.

31. Wipe any metallic debris from the face of the secondary speed sensor (Figure 50).

32. Remove the oil pump as follows:
- a. Remove the fitting bolt located above the left rear corner of the oil pan gasket surface (Figure 51).

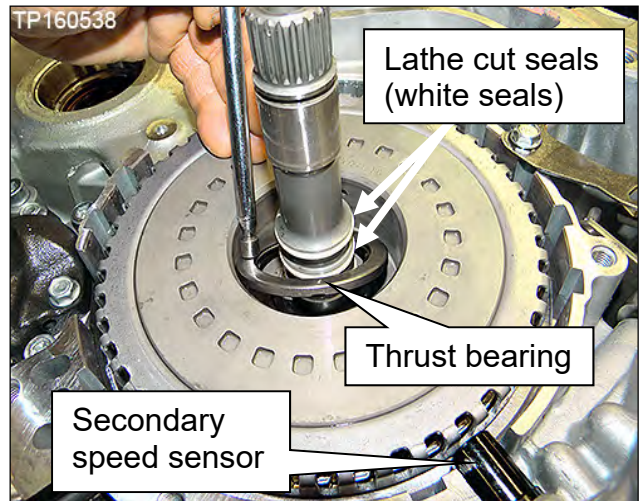

Figure 50

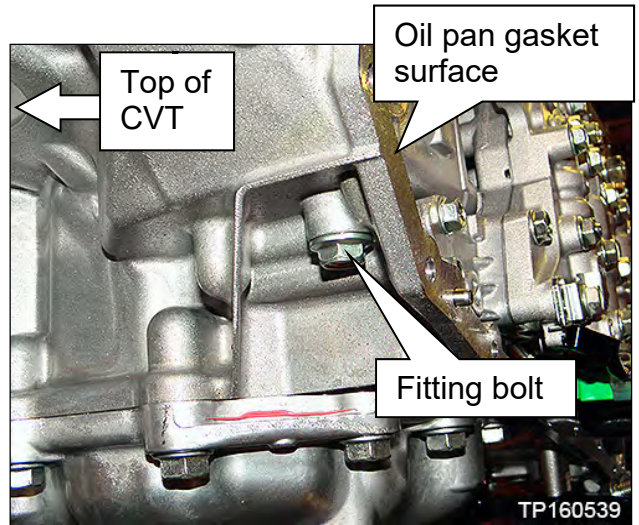

Figure 51

- b. Remove the three (3) oil pump Allen®-head bolts, and remove the oil pump (Figure 52).

HINT:

- Do NOT discard the Allen®-head bolts. These bolts will be reused.
- A new oil pump will be installed later in this bulletin.

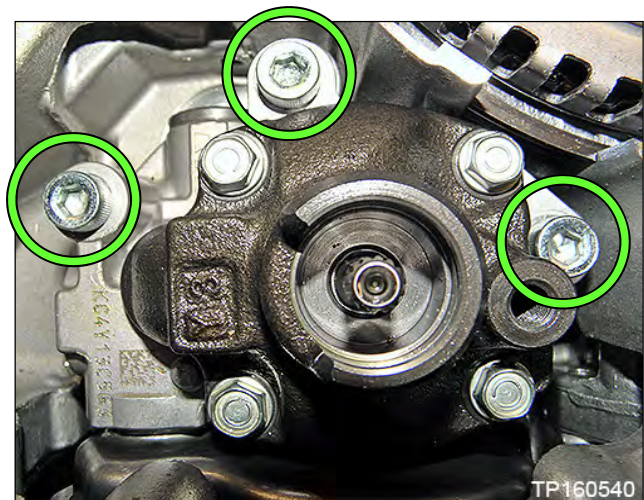

Figure 52

33. Remove the CVT fluid filter as follows:

- a. Remove the four (4) bolts and then remove the CVT fluid filter cover (Figure 53).

HINT: These bolts will be reused.

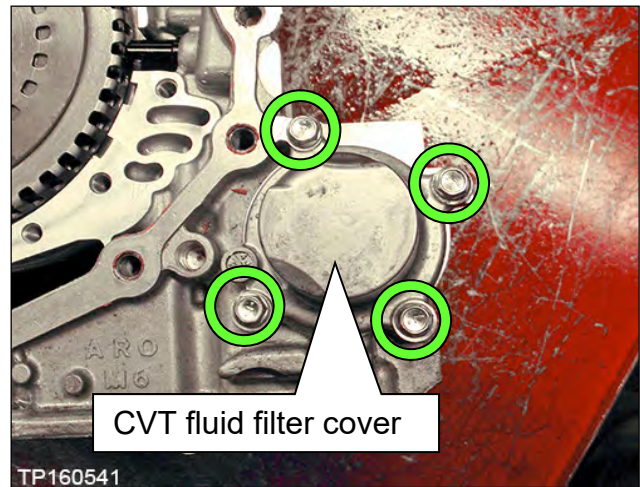

Figure 53

- b. Remove the CVT fluid filter with grommet seal and O-ring seal (Figure 54).

- Do not reuse the oil filter and seal. They will be replaced later.
- The grommet seal is fitted to the bottom end of the filter and is included with the replacement filter (Figure 55).

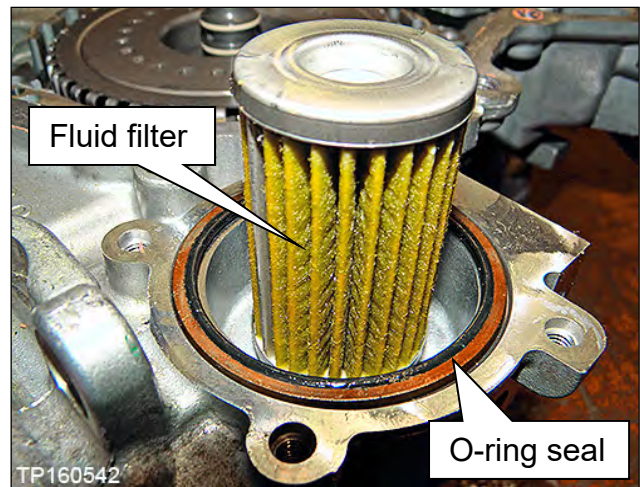

Figure 54



Figure 55

Clean the CVT case surfaces

34. Thoroughly clean the mating surfaces of the CVT case and torque converter housing.
- A plastic scraper can be used.

NOTICE

To prevent debris from entering the CVT and causing damage:

- DO NOT use sanding discs, similar abrasive tools, or metal blades.
- Use brake cleaner or equivalent solvent and lint free towel only.
- Make sure rust and debris have been cleaned off of dowel pins and receiving holes (Figure 56 and Figure 57).

35. Clean the dowel pins and dowel pin receiving holes of any rust and debris (Figure 56 and Figure 57).

HINT: Use a small wire brush or similar tool at the inside surface of the dowel pin holes. DO NOT SCRAPE THE CVT CASE mating surfaces.



Figure 56



Figure 57

Clean the Oil Passages in the CVT Case, Oil Pump Cover, and CVT Filter Area

In the following steps, brake cleaner or a suitable cleaning solvent and compressed air will be used to clean out the oil passages in the CVT assembly.

CAUTION

To prevent debris from entering your eyes and causing personal injury, wear eye / face protection when using compressed air and cleaning fluids and regulate the air pressure up to a maximum of 75 PSI.

36. Clean the area where the CVT fluid filter fits (Figure 58).
 - Make sure the old filter grommet seal is removed (Figure 55).

37. Clean the fluid passages to and from the filter (Figure 58).

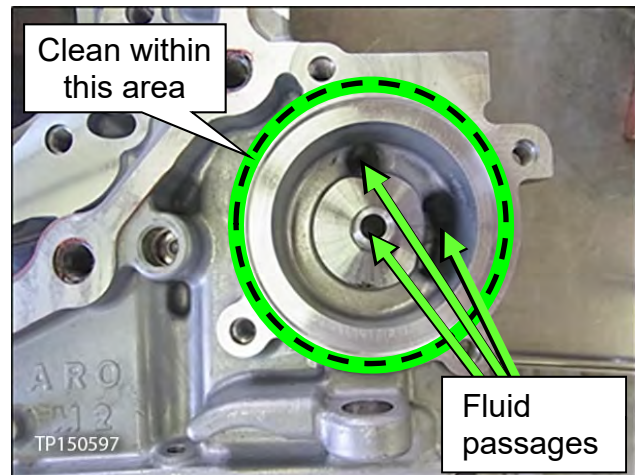

Figure 58

38. Use brake cleaner in all oil passages of the CVT case where shown in Figure 59 and Figure 60.
- Do not spray brake cleaner into the clutch pack.

39. Apply compressed air in the same passages.

CAUTION

To avoid being struck by debris, do not stand in front of the passages while using compressed air.

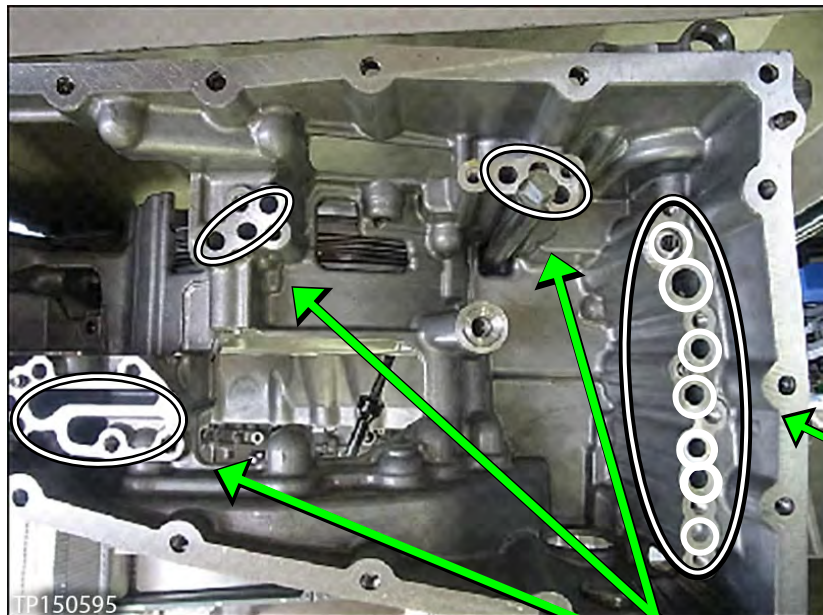

Figure 59

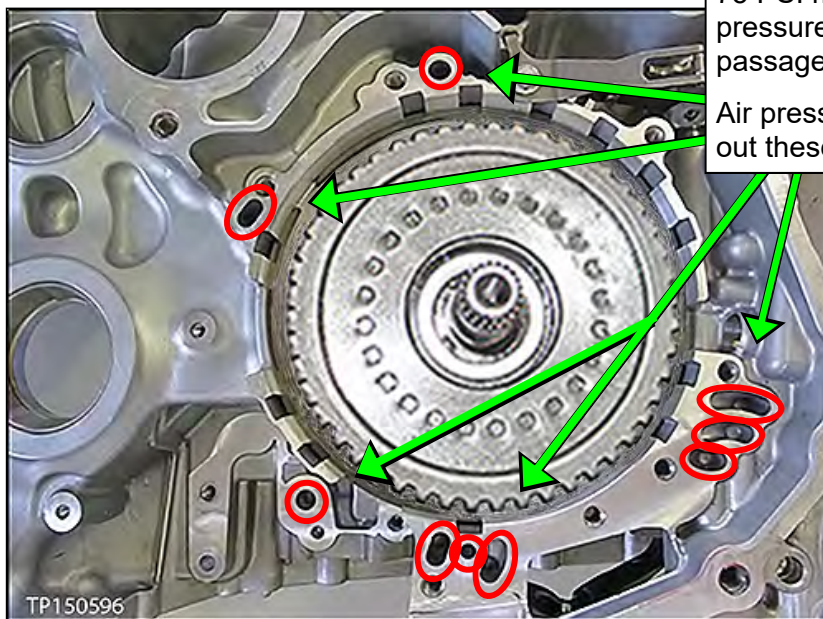

Figure 60

40. Temporarily install the fluid filter cover.

New Oil Pump Installation

For the following service procedures, a **PARTS KITS REFERENCE TABLE** is provided on page 99.

- Use the check off column on the left to ensure the correct new part is installed at each step, and then attach it to the repair order.

41. Install the new oil pump using the three original Allen®-head bolts (Figure 61).

HINT:

- Finger tighten the Allen®-head bolts at this time.
- The oil pump kit includes a new oil pump, O-ring, and snap ring.

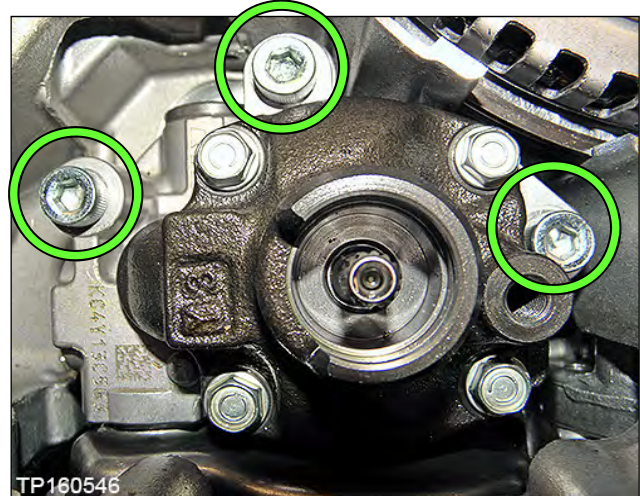

Figure 61

42. Place a new O-ring on the fitting bolt, and then coat the O-ring with CVT fluid (Figure 62).

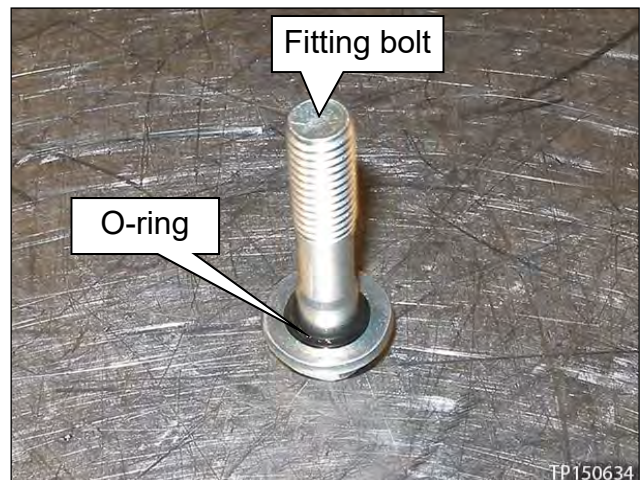

Figure 62

43. Install the fitting bolt finger tight (Figure 63).

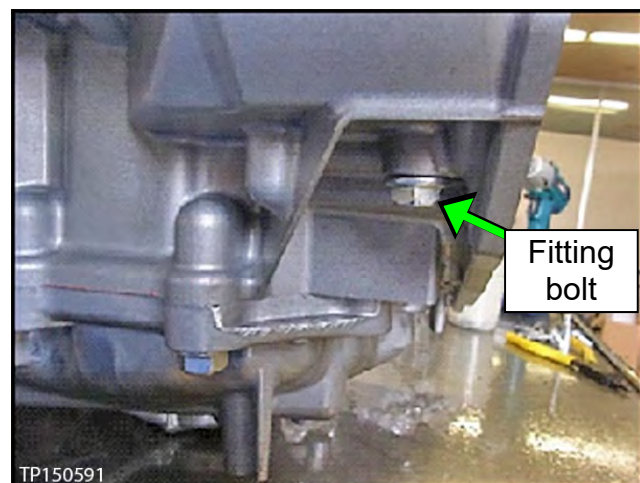

Figure 63

44. Torque the three (3) Allen®-head bolts and fitting bolt.
- Allen®-head bolt torque: 17.6 – 20.6 N•m (1.79 – 2.1 kg-m, **13.0 – 15.2 ft-lb**)
 - Fitting bolt torque: 26.0 – 30.0 N•m (2.65 – 3.06 kg-m, **19.2 – 22.1 ft-lb**)

45. Install the new snap ring (Figure 64).

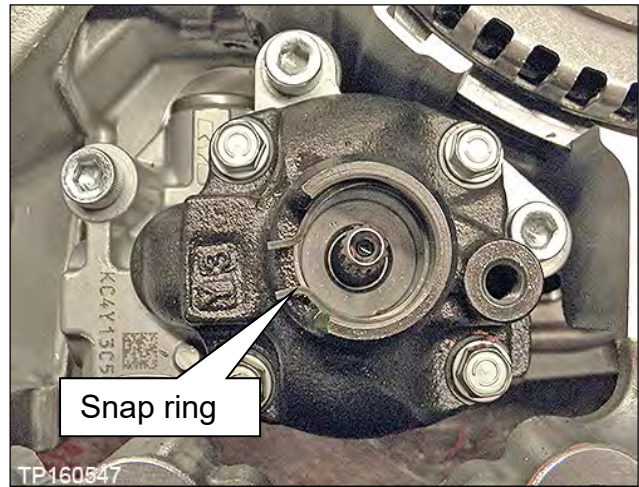

Figure 64

Replace the Side Cover – Pulleys and Belt (sub-assembly)

Review video # 547: “CVT Belt and Pulley Replacement” and fast forward to minute marker 3:14. This video is located under the TECH TRAINING GARAGE VIDEOS tab in Virtual Academy.

46. Temporarily install the dummy cover with three (3) bolts, finger tight (Figure 65).

IMPORTANT:

- Do not install the thrust bearing to the clutch assembly bore at this time.
- If the cover does not sit flush, continue to **Dummy Cover Troubleshooting**, below. Otherwise, skip to step 53.

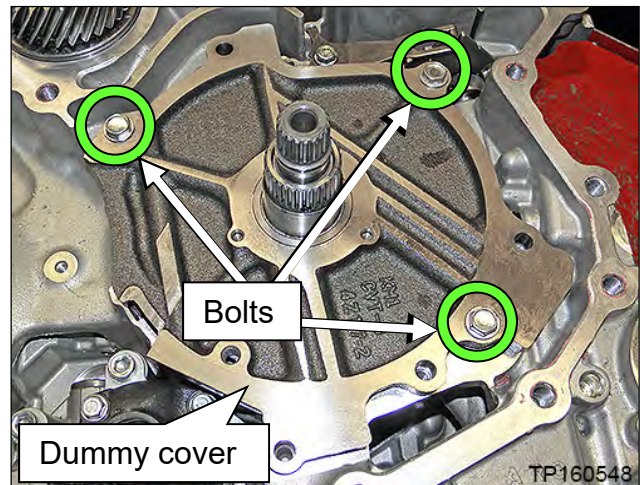

Figure 65

Dummy Cover Troubleshooting

- If the dummy cover does not sit flush, the clutch pack may not be fully seated.
- Figure 66 shows the clutch pack fully seated.
- The clutch pack is not fully seated if it is not below the surface that the dummy cover bolts to.
- To fully seat the clutch pack, follow the instructions in steps 47-51.

HINT: Always handle the clutch pack by the input shaft.

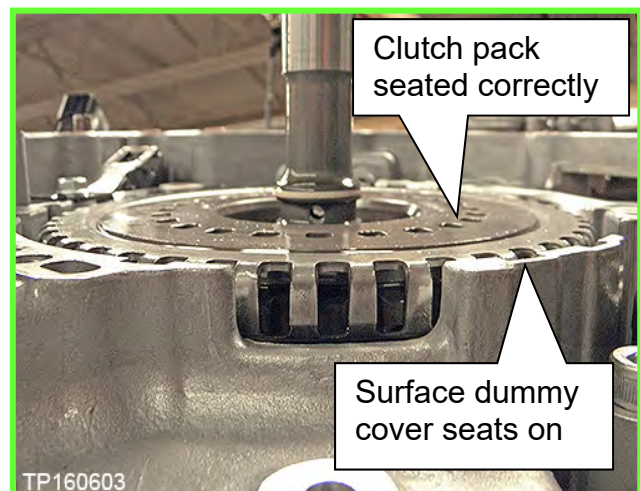

Figure 66

47. Remove the dummy cover.

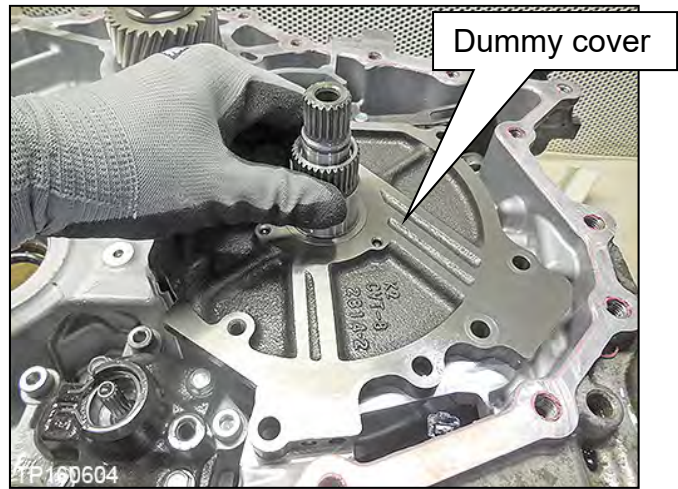

Figure 67

48. Pull the clutch pack by the input shaft to remove the entire clutch pack.

- Make sure the O-ring is not installed at this time, or it could be damaged during reassembly.

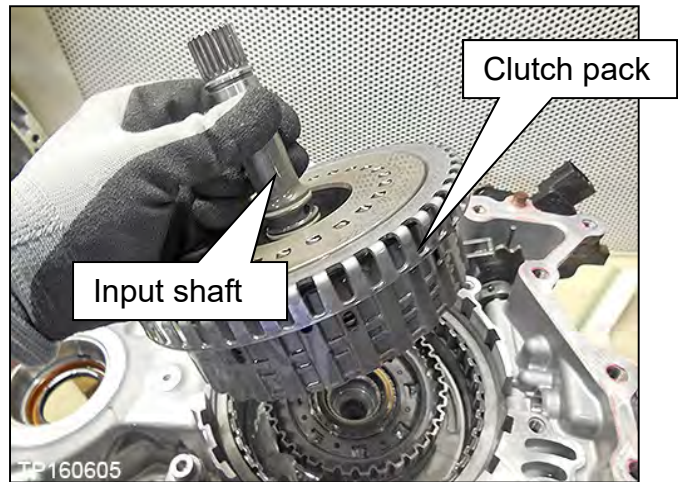

Figure 68

49. Using an appropriate tool, gently align the layers of the clutch pack.

- The bottom of the clutch pack is shown in Figure 69.

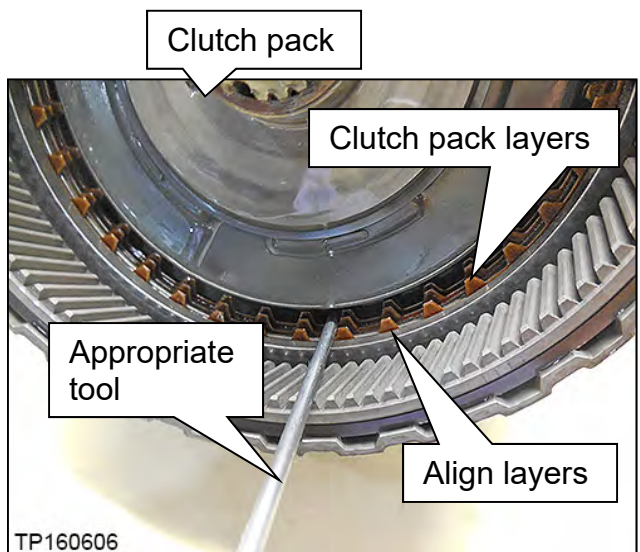

Figure 69

50. Reinsert the entire clutch pack while holding the input shaft.

51. Gently jiggle the input shaft until the clutch pack seats below the case lip.

- If the clutch pack does not seat, rotate back and forth from the input shaft and jiggle.
- If the clutch pack still does not seat, repeat from step 48.

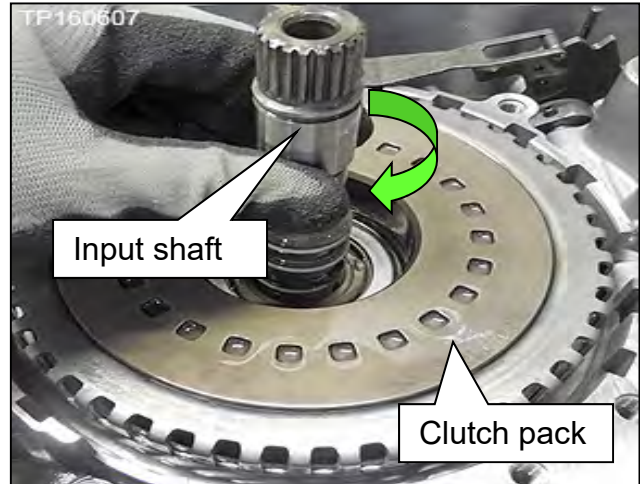

Figure 70

52. Return to step 46.

53. Temporarily install the converter housing onto the CVT case with three (3) bolts finger tight (Figure 71).

NOTICE

To prevent CVT damage when fitting the CVT case surfaces, DO NOT use the bolts to draw in the case halves. Make sure the case surfaces are flush and have no gaps prior to installing the bolts.

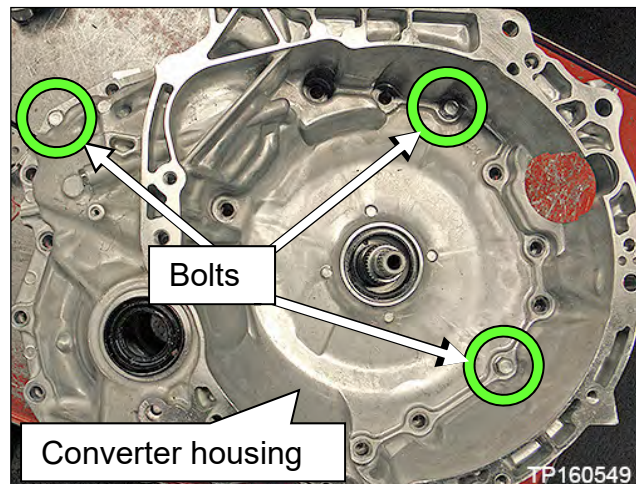

Figure 71

54. Rotate the CVT case so that the converter housing faces down and side-cover faces up.
- CVT lifter bracket J-51595 and CVT Lifting Eye/Swivel Assembly J-51595-1 can be used for this step. See Figure 73.

NOTICE

- Use plastic or wood blocks to support the CVT while rotating to prevent contact with the manual shaft and damage to the CVT (Figure 72). The manual shaft is longer than the oil pan mating surface.
- To avoid damage to the CVT, note the location of the terminal connector harness so that the terminal connector harness does not become pinched between the CVT case and the work bench or supporting blocks.

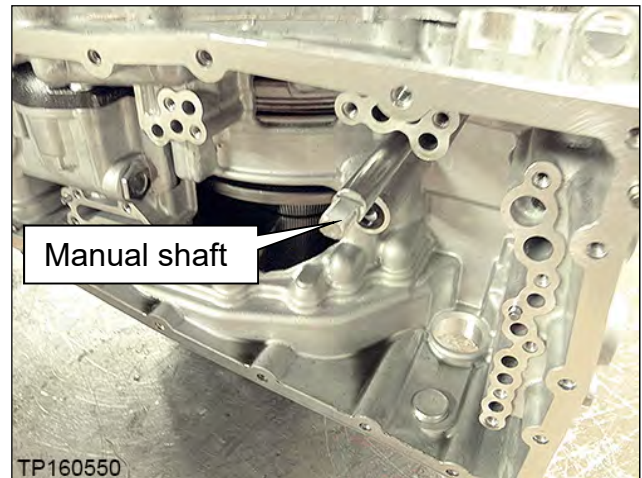

Figure 72

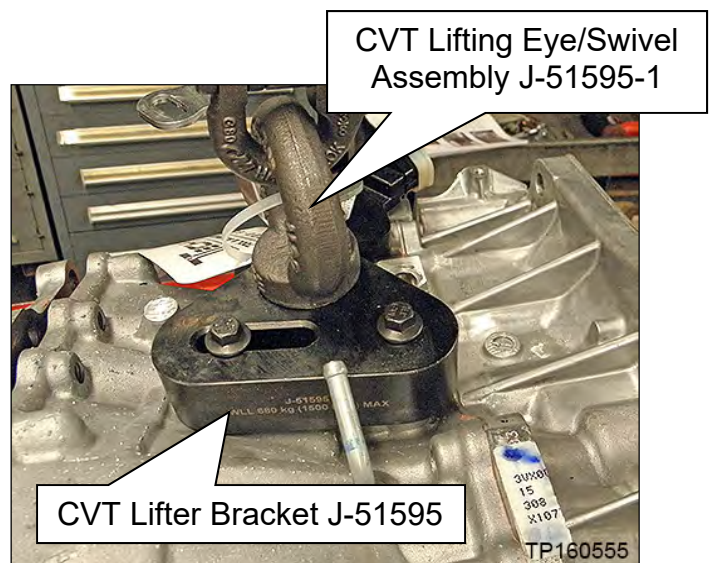

Figure 73

55. Rotate the primary pulley by hand to check the pulley's rotational characteristics.

IMPORTANT: Remember the pulley's rotational characteristics. This will be used as a reference after the new side cover pulleys and belt sub-assembly (sub-assembly) have been installed.

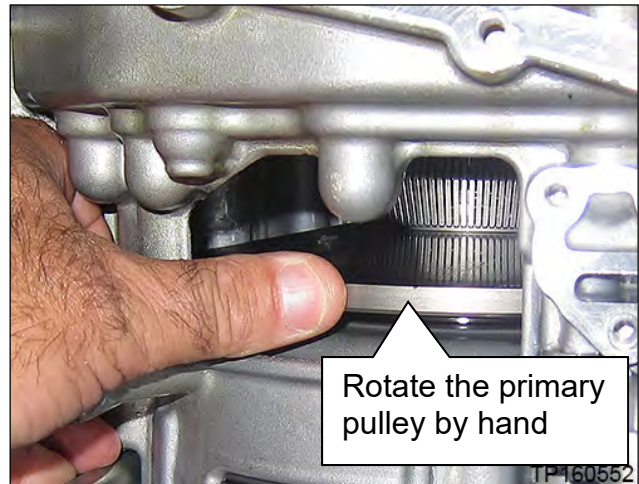

Figure 74

CAUTION

To avoid personal injury, do not place fingers between the pulley and the CVT case or they may become pinched.

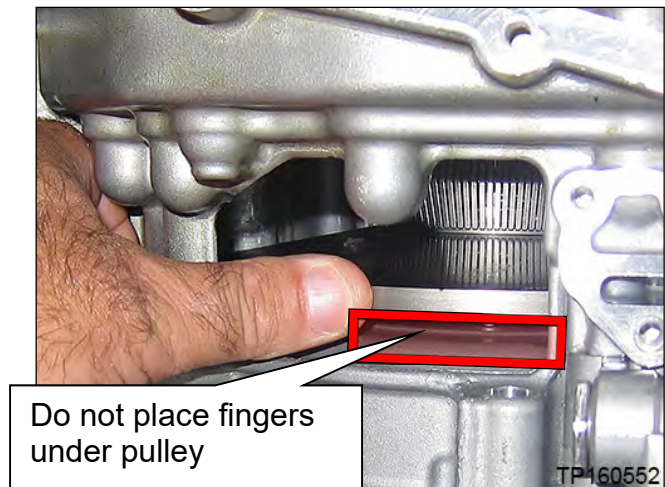

Figure 75

56. Remove the nineteen (19) side cover fixing bolts (Figure 76).
- These bolts will be replaced with new ones and will not be reused.

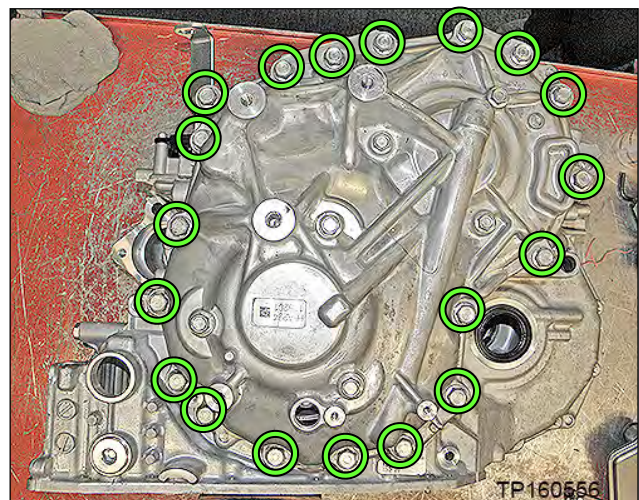
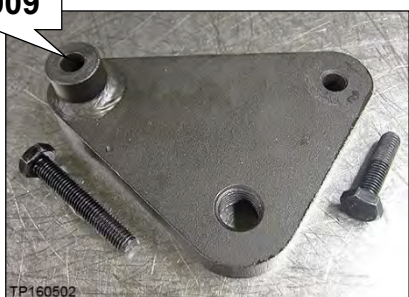
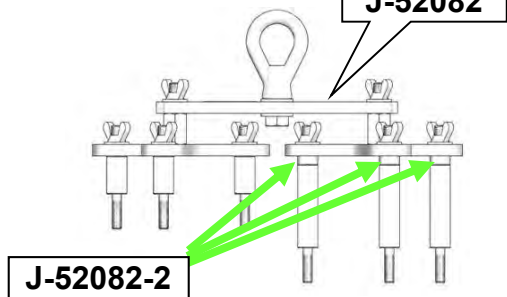
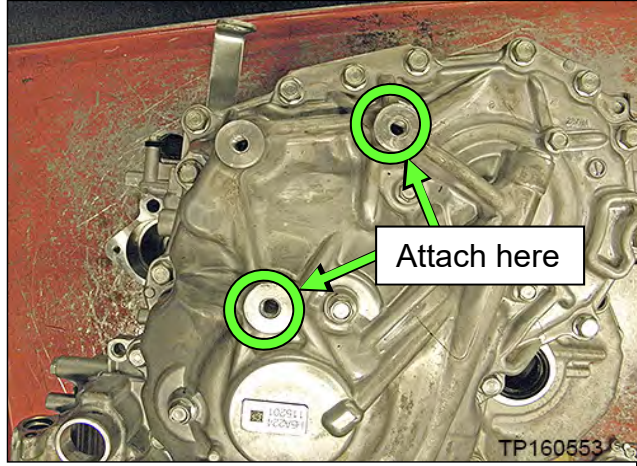
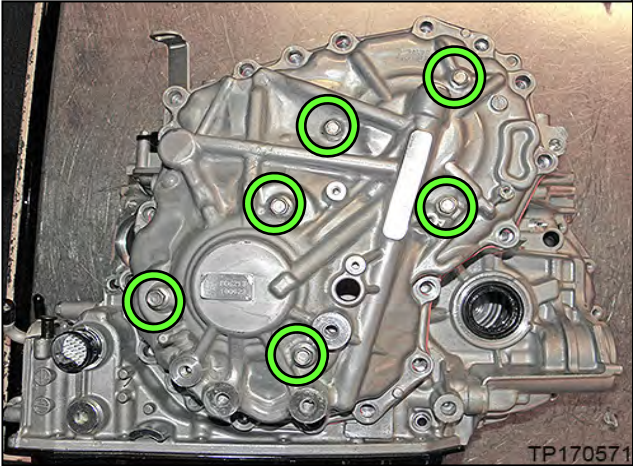

Figure 76

HINT: When working with sub-assembly install, uninstall, and bracket attachment, it is critical that CVT and sub-assembly are level. If not level, the pulleys and bearings can sit slightly at an angle and will hinder installation.

57. Attach the appropriate lifting fixture to the side cover (Figure 77 - Figure 80).

- For Altima, proceed to step 58 on page 40 for lifting fixture procedure.
- For Rogue, proceed to step 61 on page 42 for lifting fixture procedure.

<p>For Altima use tool J-51909 with eyelet J-51595-1</p>	<p>For Rogue use tools J-52082 with spacers J-52082-2</p>
<p>J-51909</p>  <p>Figure 77</p>	<p>J-52082</p>  <p>Figure 78</p>
 <p>Figure 79</p>	 <p>Figure 80</p>

Altima Lifting Fixture procedure

58. Attach Lifting Fixture J-51909 (Figure 81) with eyelet from J-51595 (Figure 73) to the side cover at point shown in Figure 82.

- Lifting Fixture bolt torque (Max.): 45 N•m (4.6 kg-m, **33 ft-lb**)

NOTICE

Use caution when attaching the side cover to avoid cross threading and damage to the lifting fixture.

- Eyelet bolt torque: Hand tight.

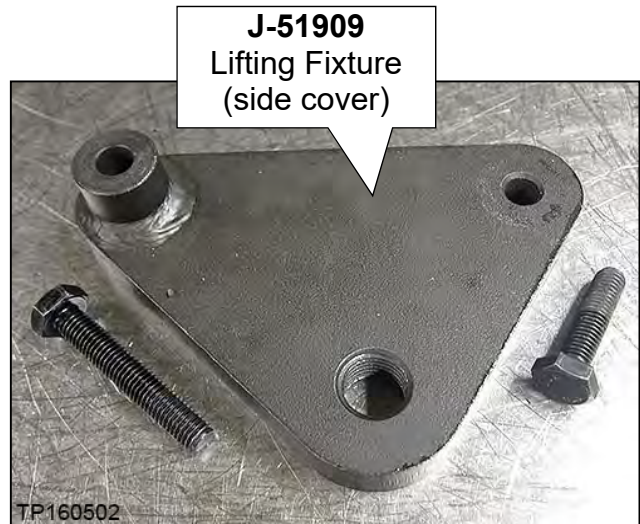

Figure 81

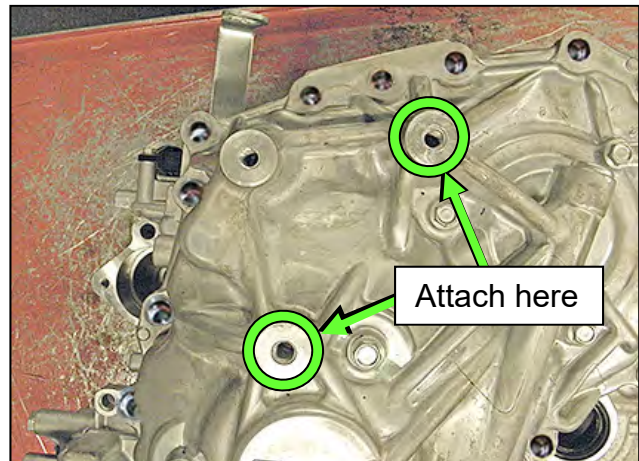

Figure 82

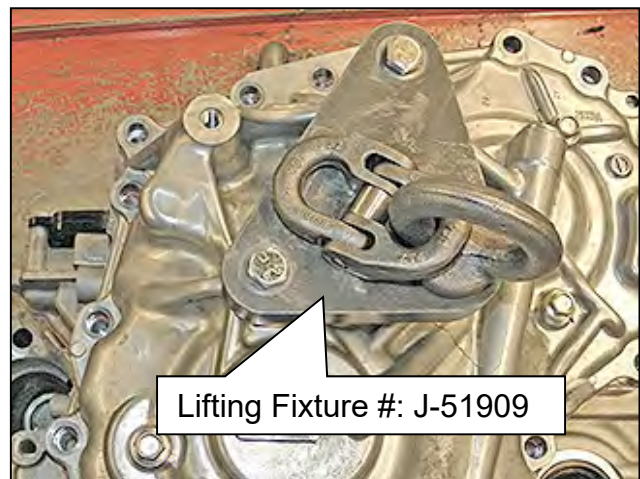

Figure 83

Altima Lifting Fixture procedure (continued)

59. Install the two alignment Guide Pins (J-51959) as shown in Figure 84 and Figure 85.

HINT:

- The Guide Pins should be located on opposite sides of the sub-assembly.
- Guide Pins should be placed as far apart as possible.
- Guide Pins must be placed next to the dowel pins (Figure 85).

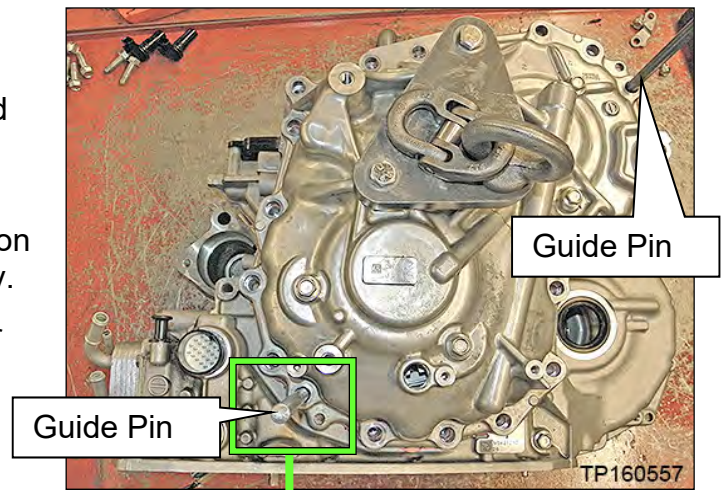

Figure 84

60. Proceed to step 64 on page 44.

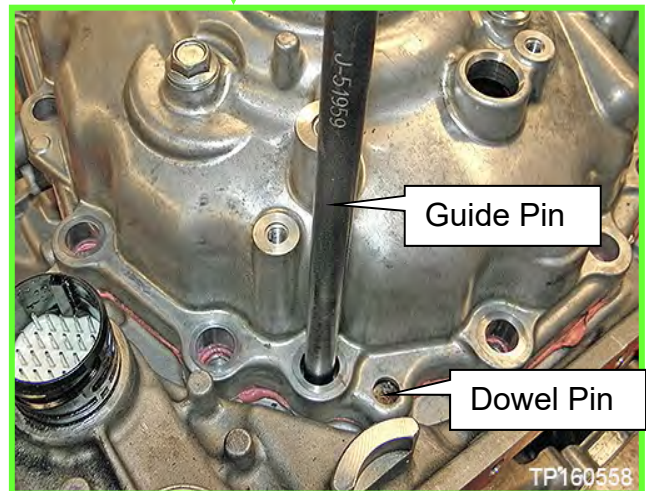

Figure 85

Rogue Lifting Fixture procedure

61. Remove the six (6) pulley bracket bolts.
 - Bolts will be reinstalled to the original pulley and belt sub-assembly.
62. Attach universal Lifting Fixture J-52082 with spacers J-52082-2 to the side cover as shown in Figure 87.

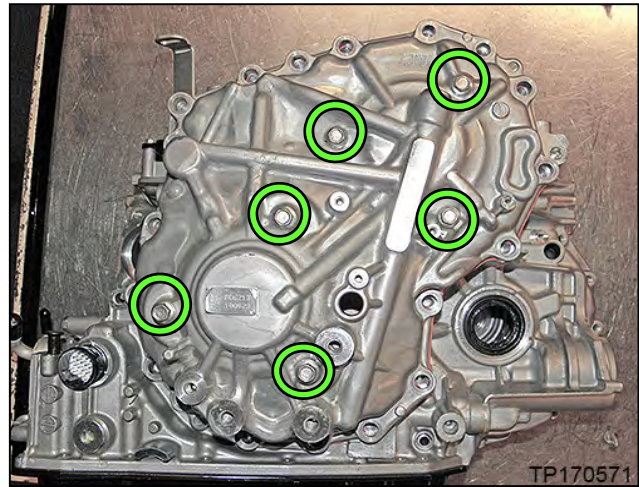
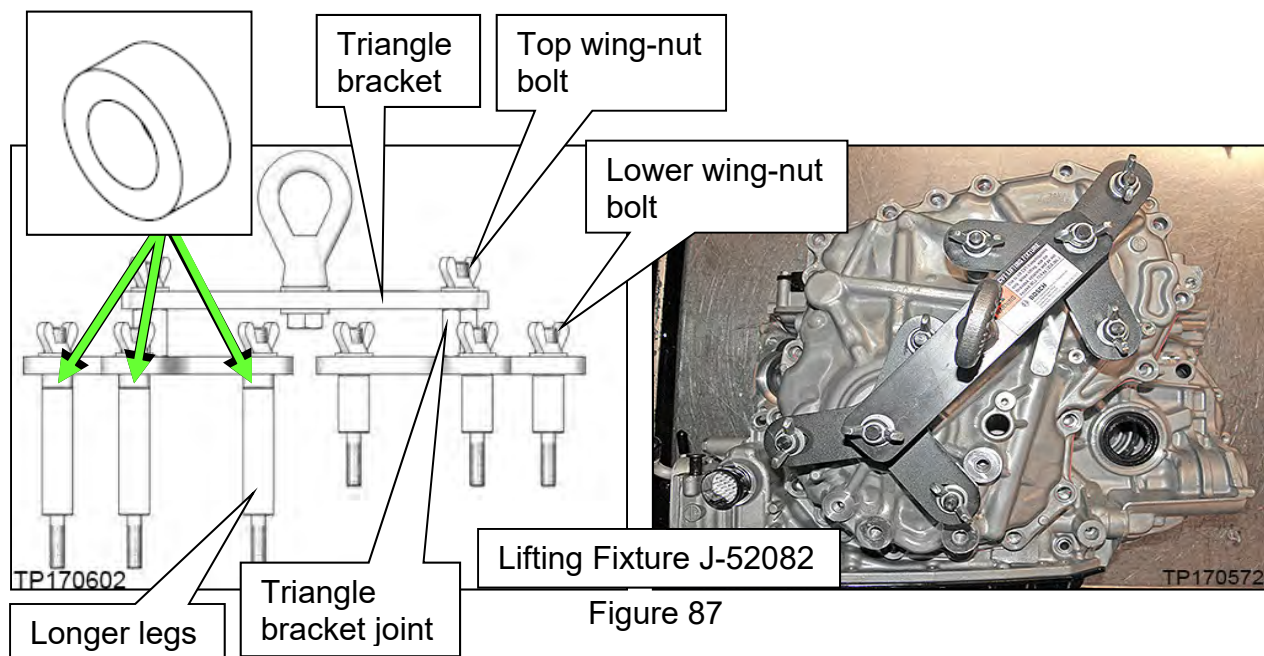

Figure 86

- a. Loosen all of the wing-nut bolts on the Lifting Fixture.
- b. Confirm that three (3) spacers (# J-52082-2) are present between the longer legs and triangle bracket as shown in Figure 87.
- c. Install the Lifting Fixture to the CVT case at the six (6) bolt holes shown in Figure 86.
- d. Tighten the wing-nut bolts on the Lifting Fixture finger tight in the following order:
 1. Tighten the lower six (6) wing-nut bolts.
 2. Tighten the two (2) joint to triangle brackets.
 3. Tighten the top two (2) wing-nut bolts, and then proceed to step 63 on the next page.

NOTICE

Use caution when attaching the side cover to avoid cross threading and damage to the lifting fixture.



Rogue Lifting Fixture procedure (continued)

63. Install the two CVT Assembly Guide Pins (J-51959 - Guide Pins) as shown in Figure 88 and Figure 89.
- The Guide Pins must be located next to the dowel pins.

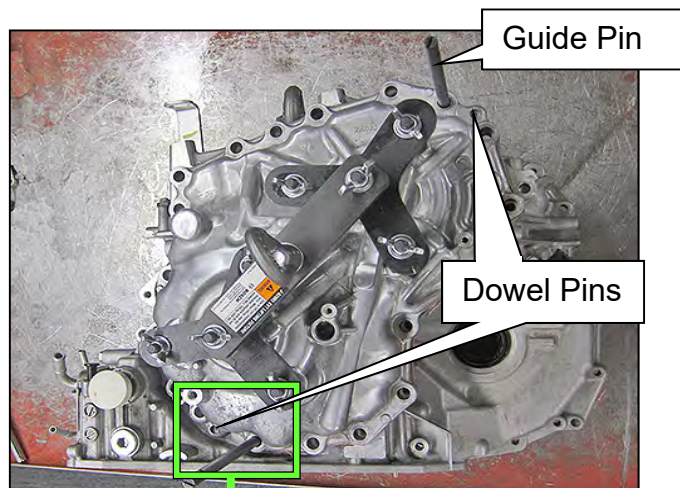

Figure 88

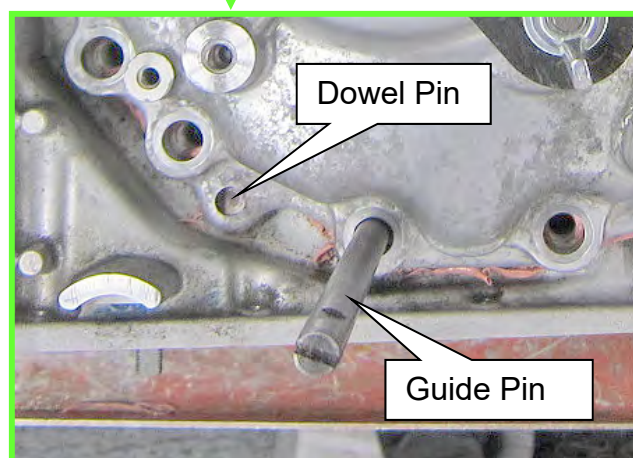

Figure 89

HINT: The following steps on the next page apply to both Altima and Rogue.

64. Raise the Lifting Fixture so that the CVT assembly weight is mostly supported by the Lifting Fixture and just slightly raised off of the work surface.
65. Loosen the side cover with a slide hammer at the three points (tool location marks) shown in Figure 90.
 - Rotate between the three (3) locations on the side cover until the CVT case separates from the sub-assembly; this can take more than one rotation to loosen sealant.

NOTICE

To avoid damage to the CVT, DO NOT use a pry-bar, chisel, etc. to separate the side cover from the CVT case.

HINT: Apply rust penetrant to the two dowel pins as needed.

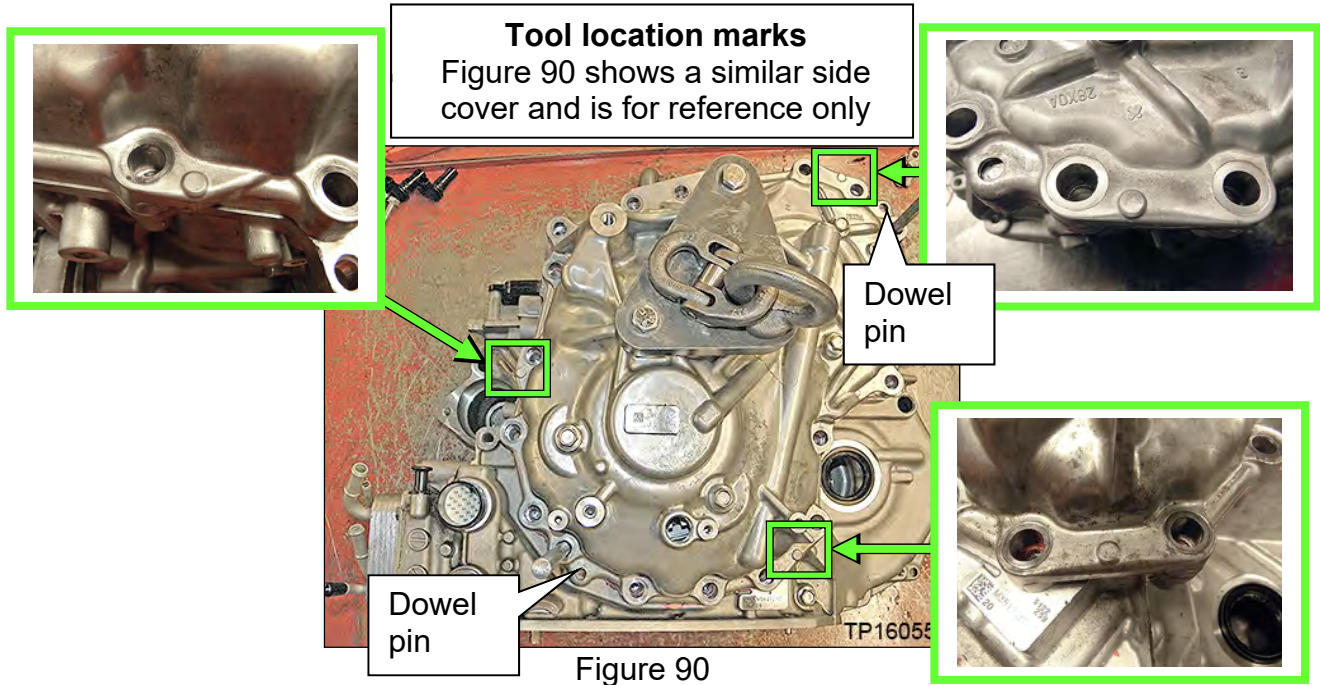

66. Raise the Lifting Fixture to remove the “side cover with pulleys and belt sub-assembly” (sub-assembly) from the CVT case (Figure 91).

NOTICE

To avoid damage to the primary speed sensor, make sure it is removed from the sub-assembly.

- The speed sensor **will** be reused.
- **DO NOT** discard the speed sensor.
- This sub-assembly **will not** be reused.



Figure 91

67. Remove the lifting fixture from the sub-assembly.
- Re-install all six (6) original bolts into the old sub-assembly.
68. Thoroughly clean the mating surfaces of the CVT case (Figure 92) that the sub-assembly was just separated from (a plastic scraper can be used).
- Confirm that the dowel pins have remained in the CVT case. If not, remove them from the sub-assembly and reattach them back to the CVT case.
- HINT:** The Guide Pins can be temporarily removed for cleaning purposes.

NOTICE

To prevent debris from entering the CVT and causing damage:

- DO NOT use sanding discs, similar abrasive tools, or metal blades.
- Use brake cleaner or equivalent solvent and lint-free towels only.
- Make sure rust and debris have been removed from the dowel pins and receiving holes.

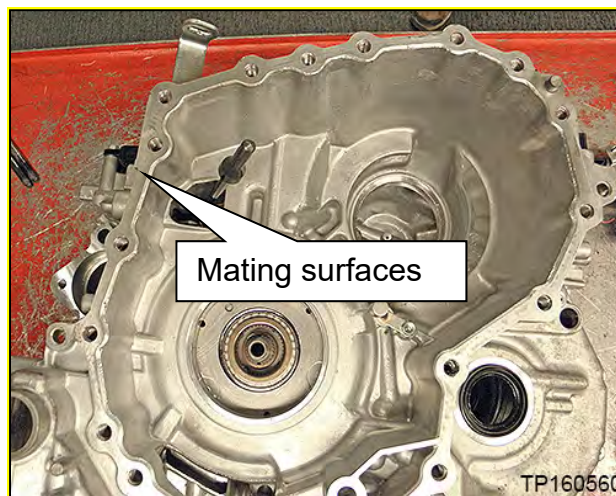

Figure 92

69. Replace the O-ring on the CVT case side with a new one from the PARTS KITS REFERENCE TABLE; do not reuse the original O-ring.

- Coat the O-ring with CVT fluid before installing.

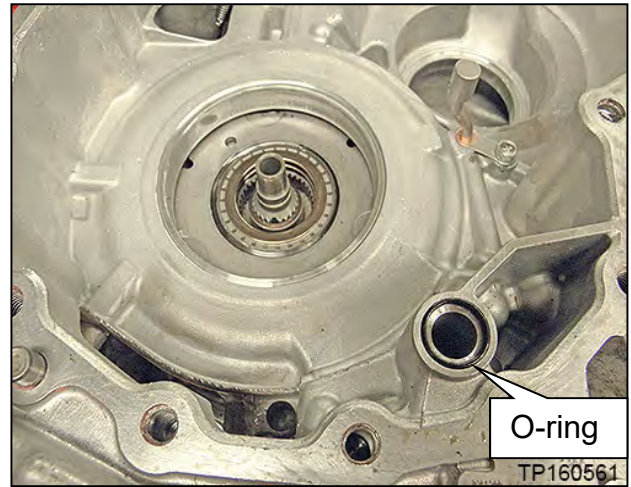

Figure 93

70. Remove the thrust bearing from the planetary carrier plate (Figure 94).

- **This thrust bearing will be reused. DO NOT discard.**

HINT: If not found on the planetary carrier plate, the thrust bearing may still be attached to the primary pulley.

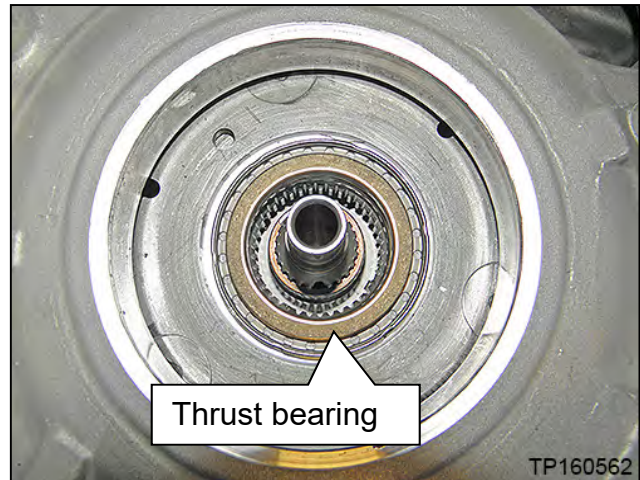

Figure 94

71. Rotate the shift select lever counter clockwise to the “L” range position (Figure 95), so that the parking pawl is at its lowest position (Figure 96).

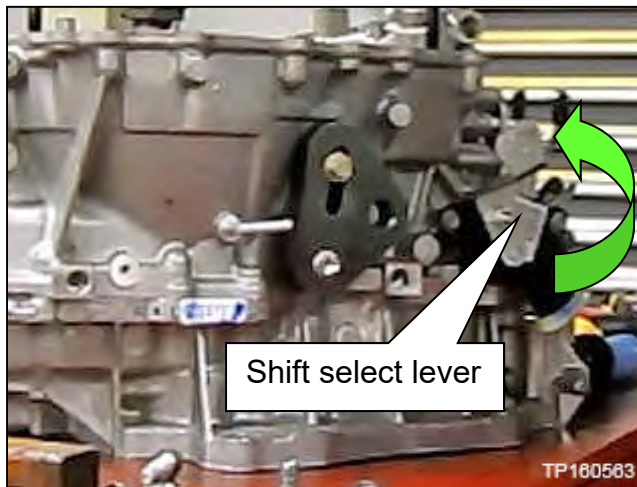

Figure 95

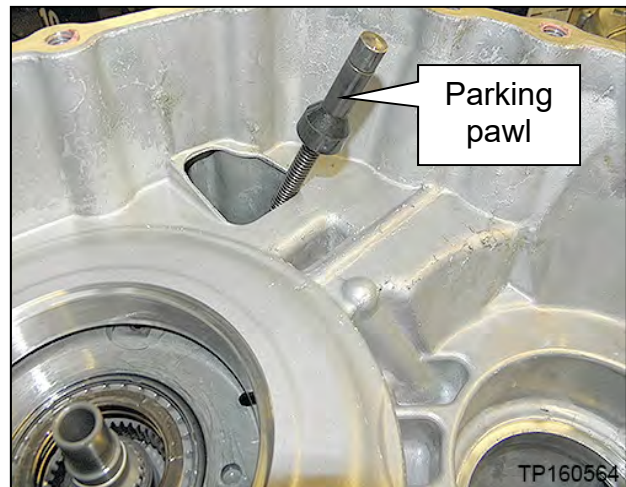

Figure 96

72. Attach the appropriate Lifting Fixture to the new sub-assembly, and then raise sub-assembly out of the shipping box.

- **For Rogue ONLY**, first remove the six (6) bolts from the new sub-assembly and then remove their O-rings before installing Lifting Fixture.
 - These bolts will be reused.
 - These O-rings will not be reused.

HINT: Do not cross thread the side cover holes when installing the Lifting Fixture. Always start the bolts by hand.

- Refer to Altima (page 40) or Rogue (page 42) Lifting Fixture procedures for correct Lifting Fixture installation.

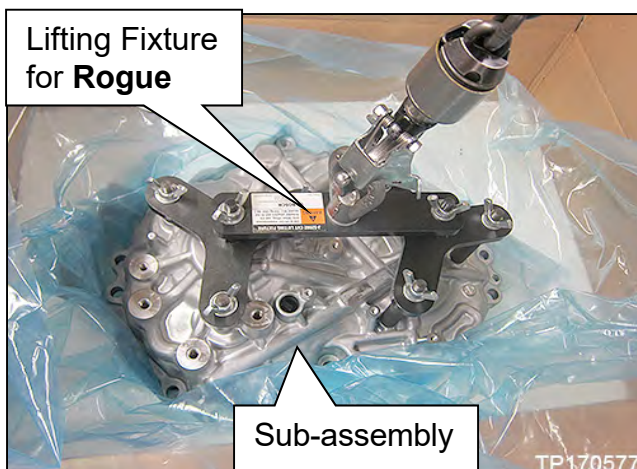

Figure 97

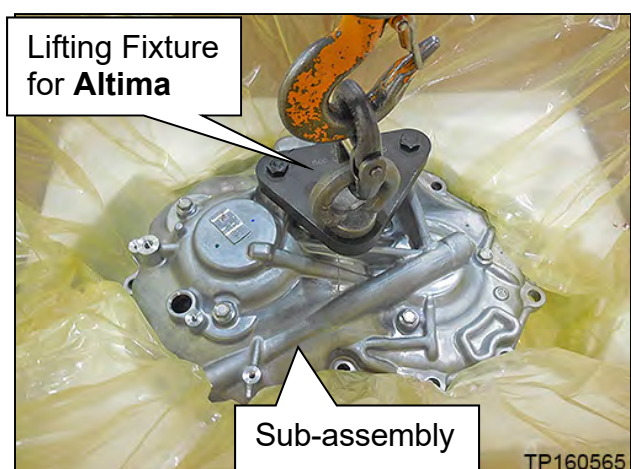

Figure 98

73. Apply one continuous 2.0 mm diameter bead of sealant along the center of the CVT case side mating surface (Figure 99).

Sealant:

- Loctite 5460 (see **PARTS INFORMATION** on page 95)
- Color: Pink

IMPORTANT:

- Confirm that the mating surfaces are clean before applying sealant.
- Make sure that the starting point and the ending point of the sealant is between two bolt holes. Overlap both ends of the bead by 3 – 5 mm.

NOTICE

To prevent possible leaks, be careful not to contact or contaminate the sealant. If the sealant has been disturbed or contaminated in any way before case assembly, thoroughly clean the mating surfaces of the CVT case and re-start from step 73.

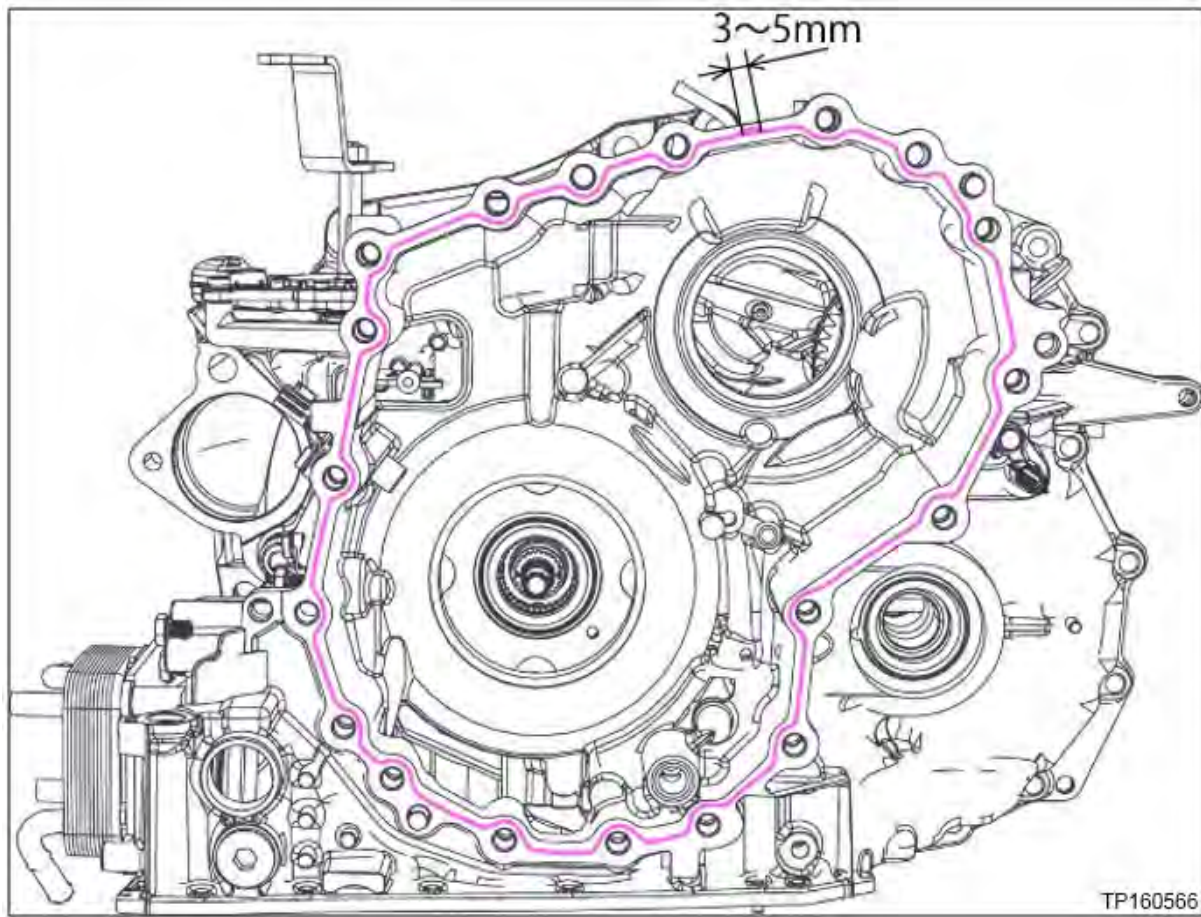

Figure 99

74. Install the original thrust bearing on the primary pulley of the new sub-assembly (Figure 100).

HINT:

- The thrust bearing surface must lay flush with the primary pulley. Any additional height will affect the total end play that is measured later in this procedure.
- The thrust bearing has two sides. Reference Figure 101 for bearing orientation.
- Apply a small amount of petroleum jelly or equivalent to the original thrust bearing to hold it in place on the primary pulley.

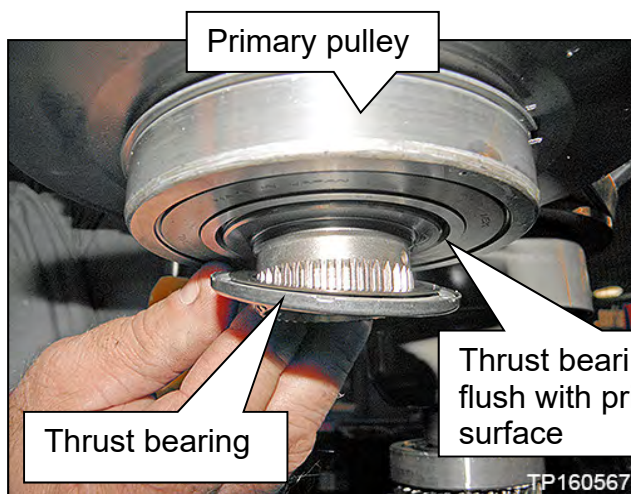

Figure 100

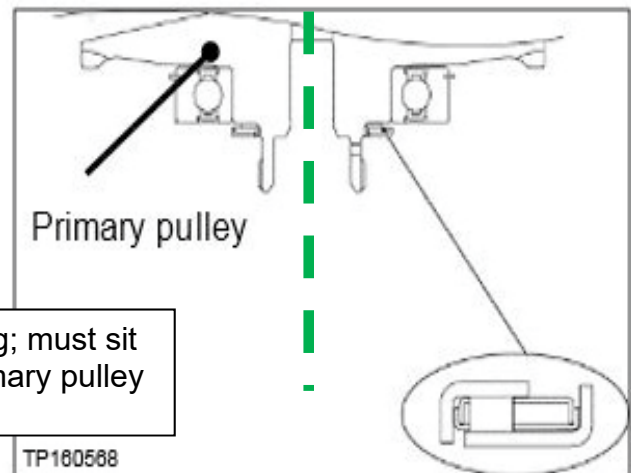

Figure 101

75. Coat the primary pulley bearing, secondary pulley gear teeth, and the secondary bearing with CVT fluid prior to installation (Figure 102 and Figure 103).

HINT: Do NOT drip any CVT fluid onto the sealant.

The following figures are for reference only and may or may not have the sealant in place or have the old sealant removed. Clean the surfaces and apply sealant when and where instructed.

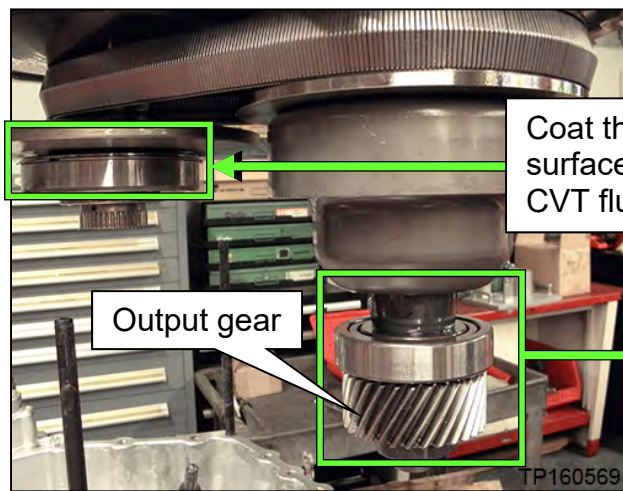

Figure 102

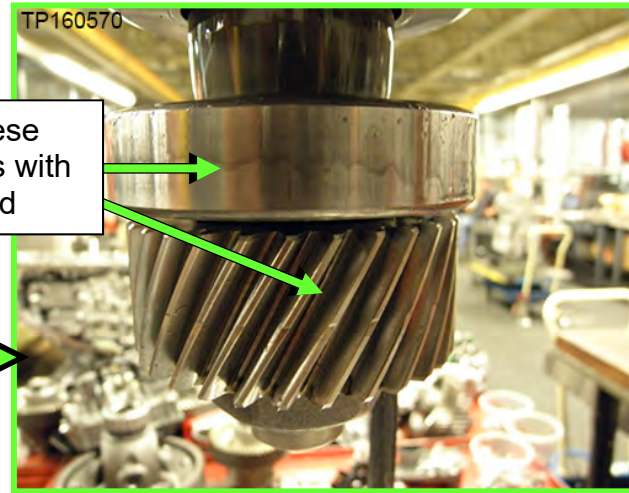

Figure 103

76. While lowering the sub-assembly, route the Guide Pins into the appropriate CVT bolt holes one at a time (the Guide Pins are different lengths for easy assembly).

HINT: Do NOT allow the output gear to contact the lubrication tube when the side cover is positioned over the guide pins (Figure 105 and Figure 106).

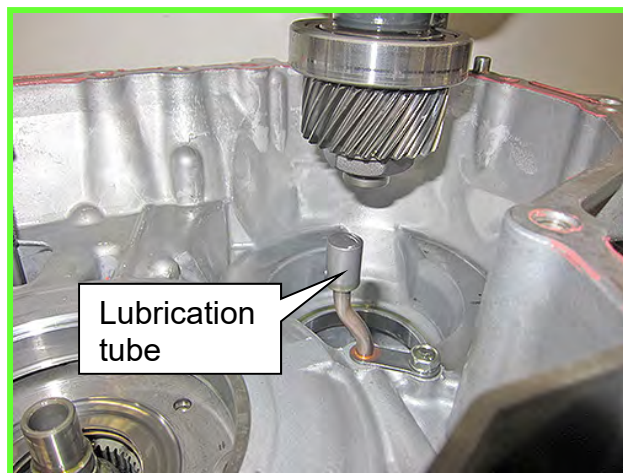

Figure 104

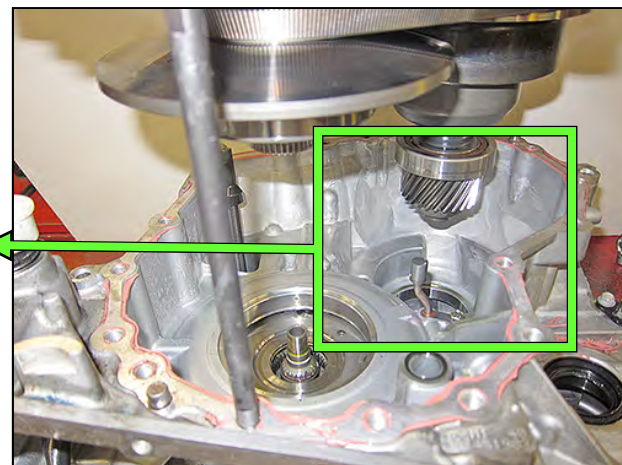



Figure 105

IMPORTANT:

Before continuing, it is recommended that you review and understand the instructions on pages 51 through 55.

The sub-assembly will lower into the CVT case without applying extra vertical force.

IF THE SUB-ASSEMBLY DOES NOT LOWER COMPLETELY,  PHYSICAL INTERFERENCE IS PRESENT.

Key Technique: Raise to remove weight on interference, adjust as necessary, and then lower again.

Use the “visual gap size” below (Figure 106 and Figure 107), between the sub-assembly and the CVT case, to determine the cause of interference.

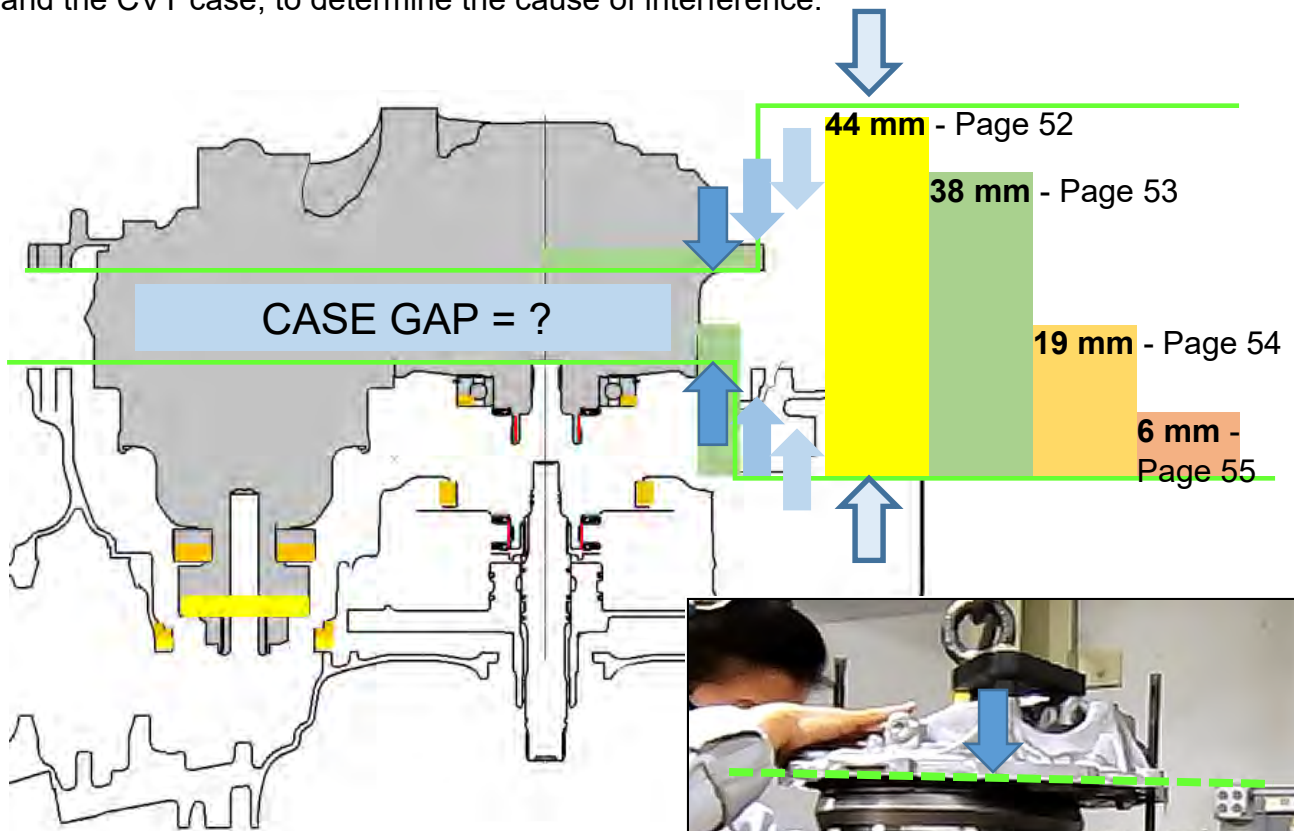

Figure 106

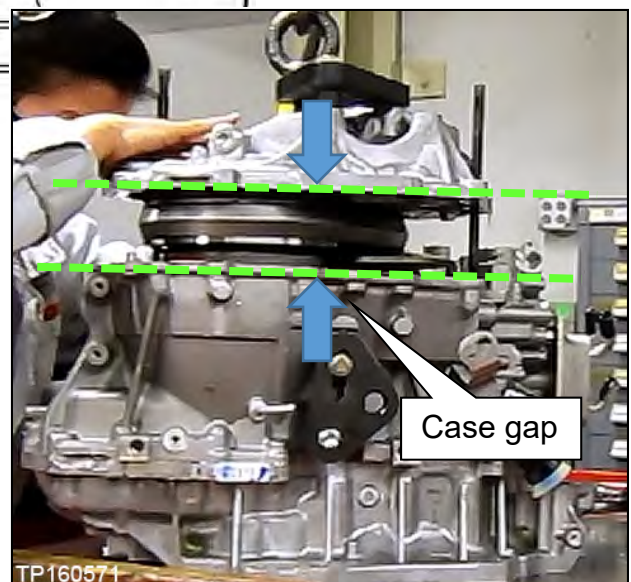

Figure 107

77. Carefully, lower the Lifting Fixture to install the sub-assembly into the CVT case until a **38 mm (1.5 inch)** gap is present between the sub-assembly and CVT case. See Figure 112 on page 53.

- Look into the bearing bore to confirm the output gear is centered (Figure 109).
- Place hands on top of the sub-assembly to keep it level and guide it into the CVT case.
 - If the sub-assembly will not lower farther than 44 mm (1.75 inches) the output gear did not clear the bearing bore (Figure 108).

Sub-assembly will not lower past 44 mm (1.75 inches)?

- Interference is present between the output gear and bearing bore.

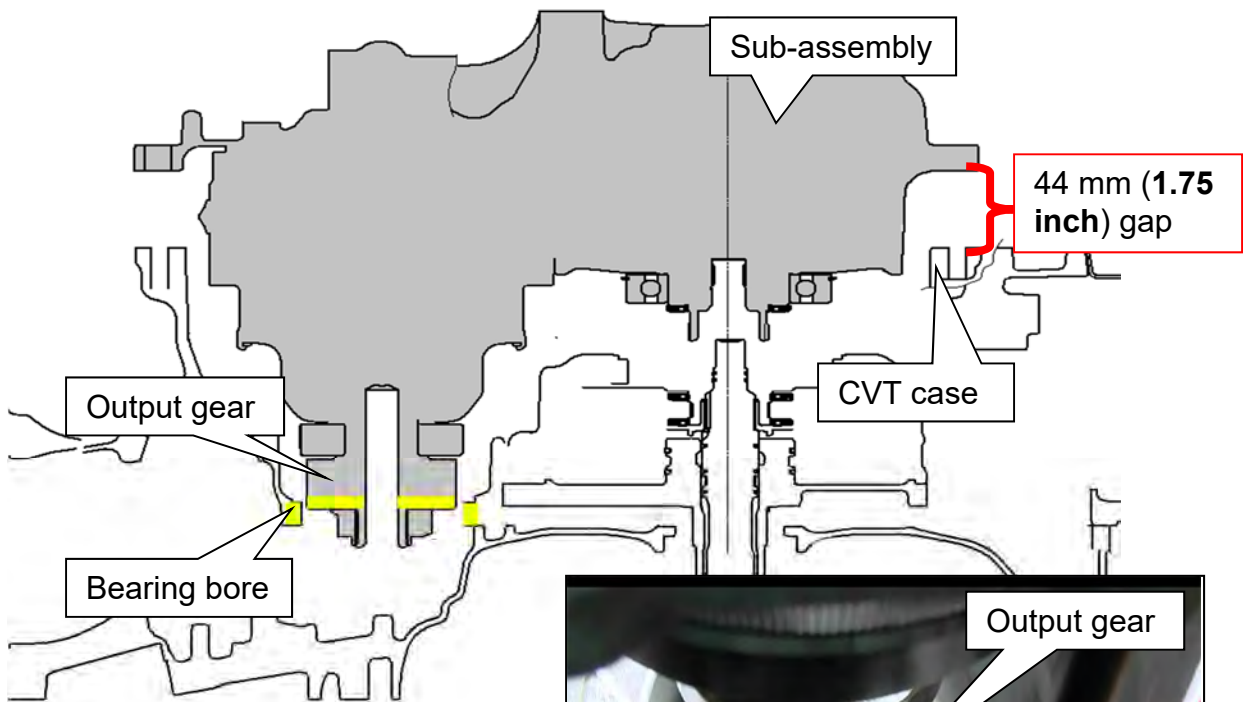

Figure 108

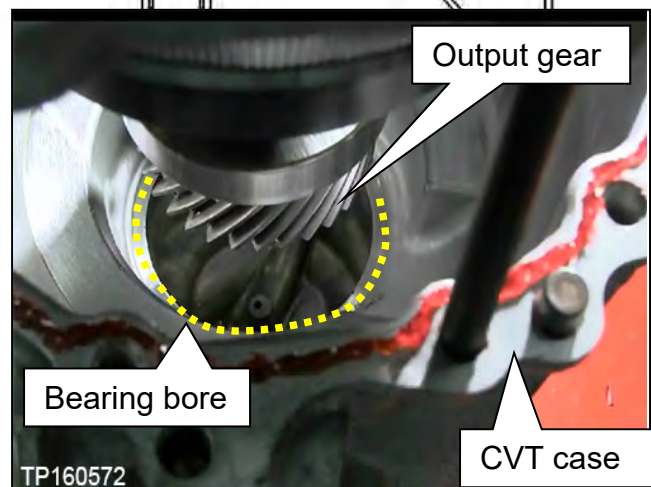



Figure 109

NOTICE

In the following steps be careful not to contact or contaminate the sealant or a leak may occur. If the sealant has been disturbed or contaminated in any way, remove the sealant completely and re-start from step 73 on page 48.

78. Align the parking rod with the parking pawl as follows:

IMPORTANT: Perform step 78 while there is a **38 mm (1.5 inch)** gap between the sub-assembly and CVT case (Figure 112).

1. Rotate the shift select lever clockwise on the side of the CVT to adjust the parking rod to the highest position.
2. Use a magnet, or similar tool, to align the parking rod in the CVT case ( in Figure 111) with the opening in the parking pawl ( in Figure 110) in the side cover.

HINT: If the parking rod is not located correctly it will keep the case from lowering.

The following figures are for reference only.

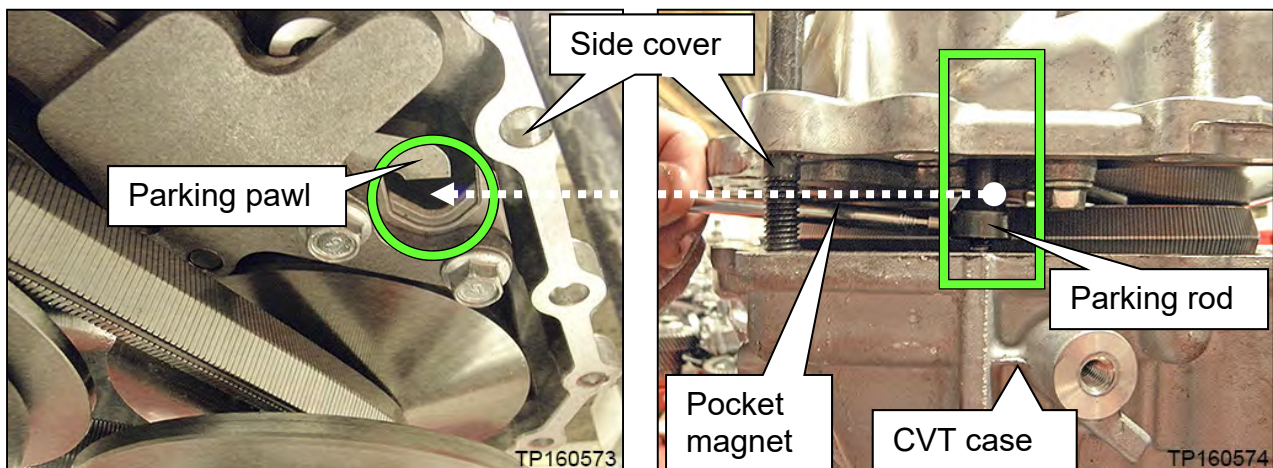

Figure 110

Figure 111

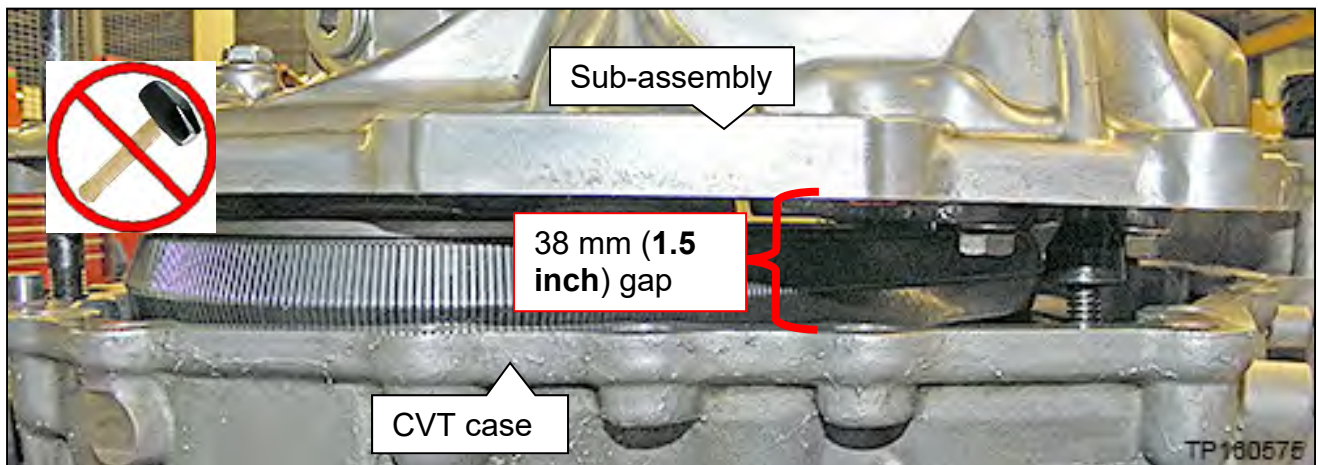

Figure 112

79. Continue to slowly lower the sub-assembly into the CVT case.

- If the primary and the secondary pulley bearings do not align properly with their bores (Figure 113) or are at an angle, a **gap of 19 mm (0.75 inches)** may be present.
 - As needed, level the sub-assembly as it is lowered into the CVT case to help the primary and the secondary pulley bearings align in their bores.
 - MINOR LEVELING ADJUSTMENTS with limited weight on the sub-assembly will help the installation. **Vertical force is not needed.**
 - Once the sub-assembly is LEVEL, the primary and the secondary pulley bearings will smoothly align while lowering.

Sub-assembly will not lower past 19 mm (0.75 inches)?

- If this occurs Do NOT force the sub-assembly into the case.
 - a. Raise the sub-assembly slightly.
 - b. Level the sub-assembly (visually check the gap between case and sub-assembly side cover and confirm that it is even all around).
 - c. Gently lower the sub-assembly.
 - d. Gently shake the sub-assembly horizontally, lower, raise and repeat as needed to help align.
 - e. Lower to engage the dowel pins and a **6 mm (0.25 inch)** gap is between the sub-assembly and CVT case.

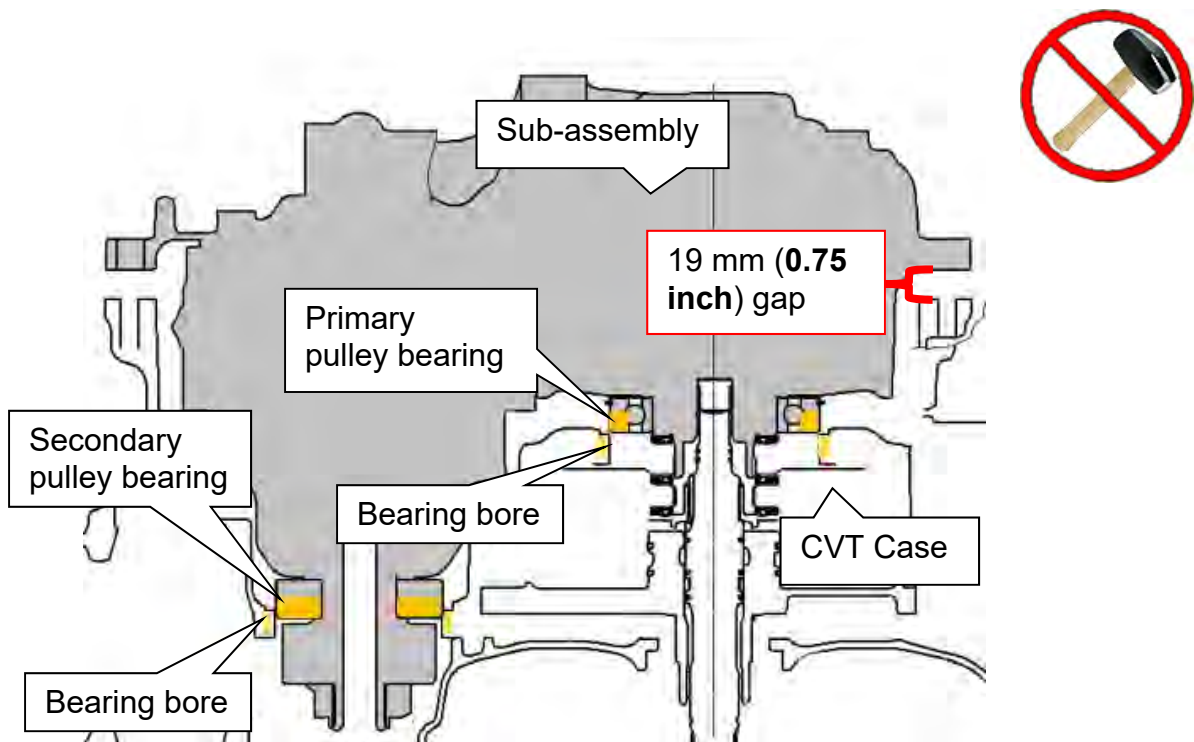

Figure 113

IMPORTANT: In the following steps the case halves must sit flush against each other without a gap before installing the bolts. The bolts CANNOT be used to draw the cases together. DO NOT APPLY VERTICAL FORCE.

80. Once the dowel pins are cleared, ease the sub-assembly down onto the CVT case until the case halves are flush.
- Confirm the dowel pins are clean and aligned and are not catching on the sub-assembly case cover.

CAUTION

To avoid personal injury, ensure your fingers are not between the CVT case and the sub-assembly. They may become pinched while seating the components together.

Sub-assembly will not lower past 6 mm (0.25 inches)?

If the sub-assembly will not lower past **6 mm (0.25 inches)**, the primary pulley splines are not aligned.

- If this occurs Do NOT force sub-assembly into the case.
 - a. Raise the sub-assembly slightly so the weight is not completely on the primary pulley splines.
 - b. Slightly rotate the primary pulley through the bottom of the CVT and then lower the sub-assembly.
 - c. Repeat as needed.

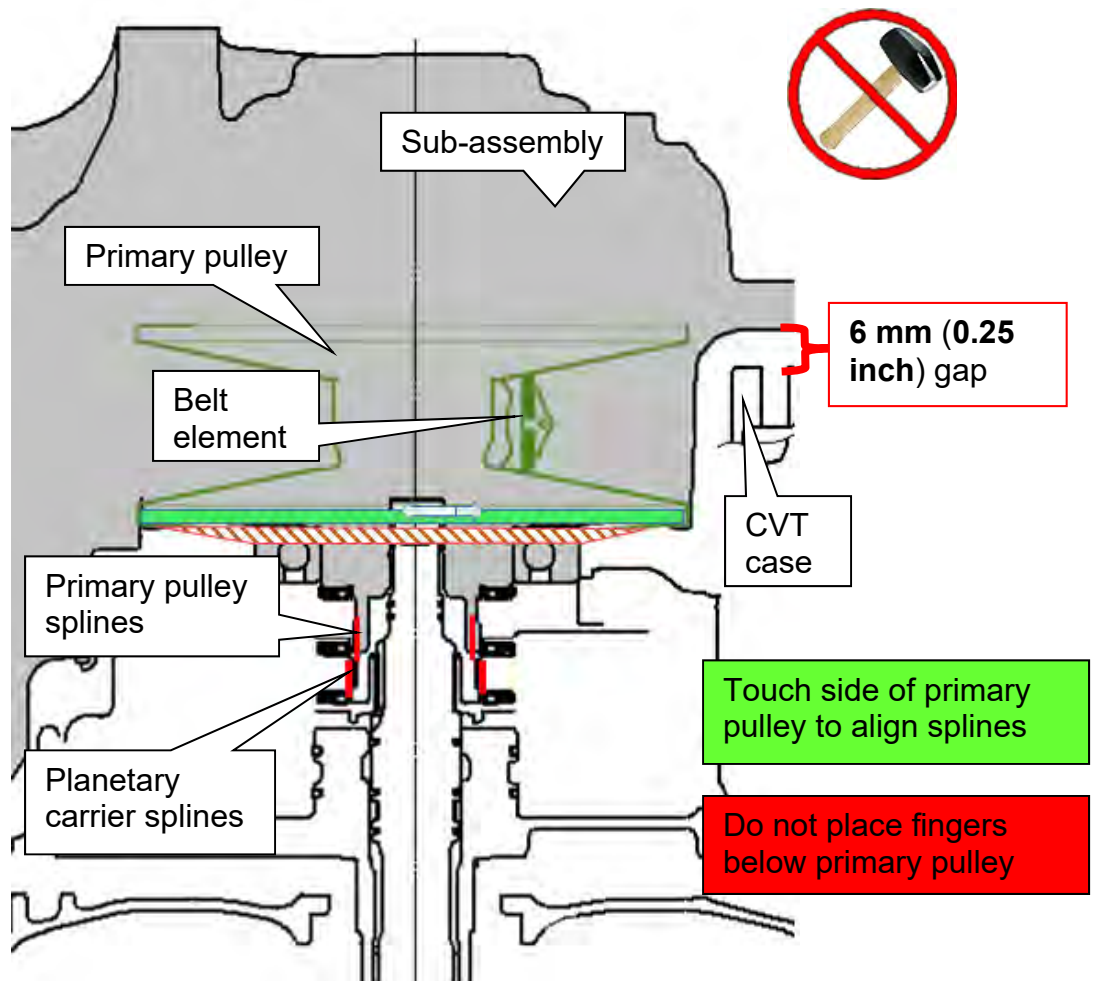

Figure 114

Rotate the shift select lever

81. Confirm the parking rod operation as follows:

- a. Rotate the shift select lever counter clockwise and confirm that all detents for each of the P-R-N-D-L are felt.
- b. Rotate the lever clockwise to return the rod back to the **P** position.
- c. Are all of the detents felt?

➤ **YES:** Proceed to step 82.

➤ **NO:** If the lever does not rotate or if all detents are not felt:

- 1) Raise the sub-assembly and remove all sealant.
- 2) Restart from step 73 on page 48.

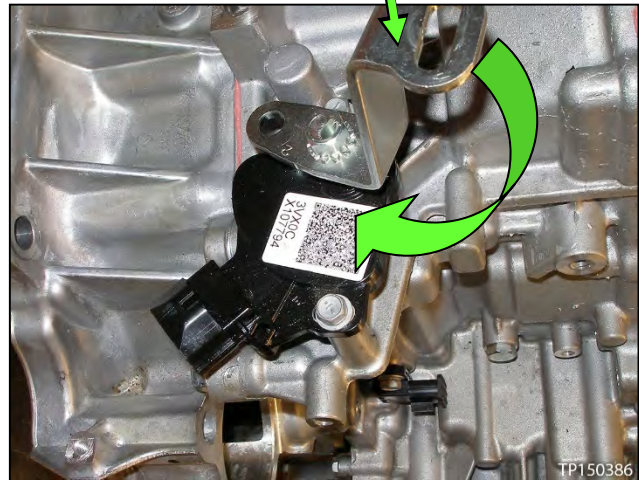

Figure 115

82. Remove the guide pins.

83. Install the new side cover bolts (Figure 116).

- Torque the first eight (8) bolts marked as ● in the sequence numbered in Figure 116 below, and then torque the rest of the bolts in a clockwise direction.
- Bolt torque: 45 N•m (4.6 kg-m, **33 ft-lb**) 19 pieces.

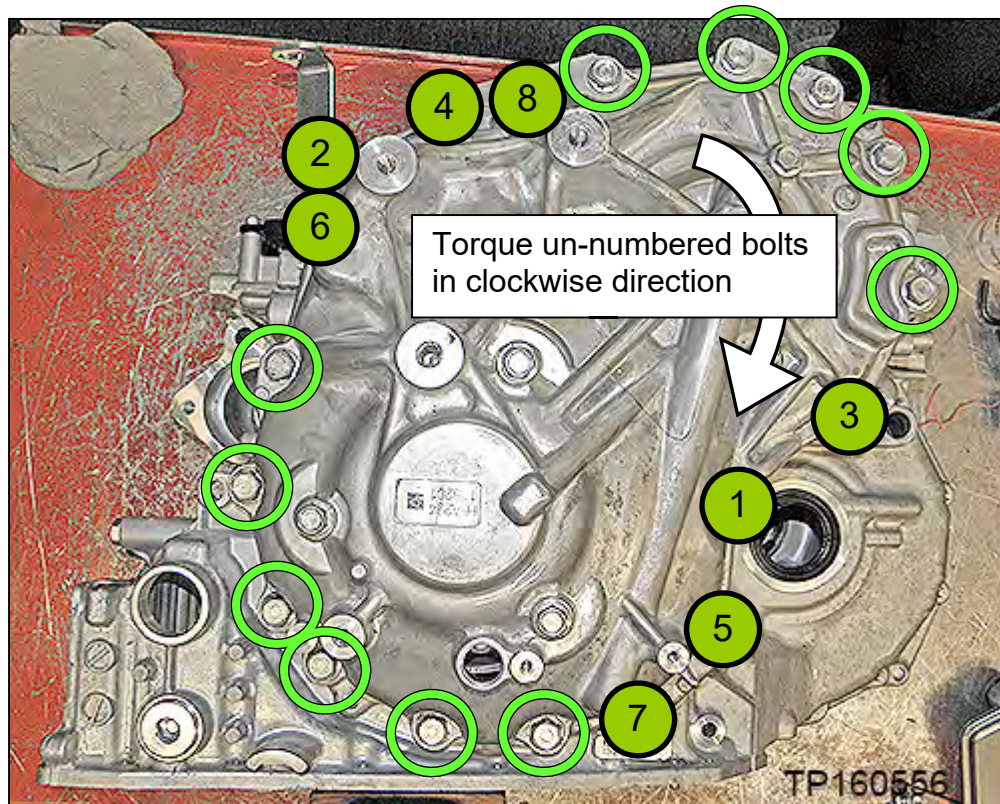

Figure 116

84. Remove the Lifting Fixture.

85. For Rogue ONLY, Install six (6) new O-rings, from the Parts Kits Reference Table, to the six (6) new pulley bearing retainer bolts that were removed from the new sub-assembly on page 47, step 72.

86. Install the six (6) new pulley bearing retainer bolts finger tight.

- Do not use tools to install.

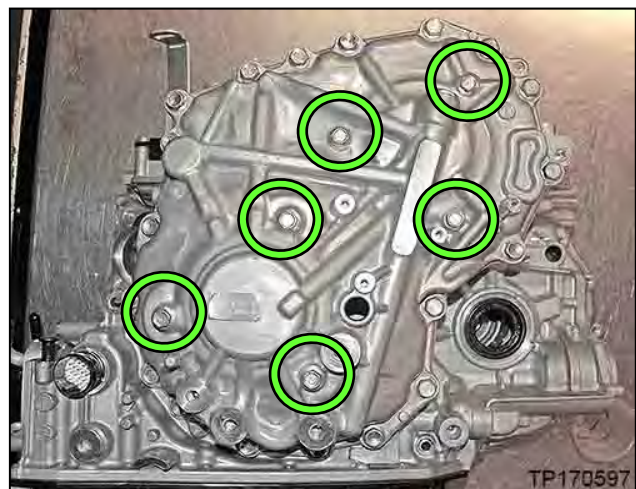

Figure 117

87. Confirm the rotational smoothness of the primary pulley as follows:
- a. With a clean hand, access the primary pulley from the bottom of the CVT.
 - b. Rotate the primary pulley by hand and confirm that the characteristic is the same as previously checked at step 55 on page 38, prior to removing the original sub-assembly.
 - If the rotational characteristic is the same or better, continue to step 88.
 - If the rotational characteristic is worse (stiffer):
 - 1) Remove the sub-assembly from the CVT case.
 - 2) Wipe and clean the sealant from the CVT case and side cover rim.
 - 3) Restart the procedure from step 73 on page 48.

88. For **Rogue ONLY** torque all six (6) bolts.
- **All other models, proceed to step 89.**
 - Bolt torque: 28 N•m (2.8 kg-m, **20 ft-lbs**).



Figure 118

89. Install the CVT case side axle seal (Figure 119).
- Use Seal Installer J-52281 and Driver Handle J-8092.
 - Apply a light coat of CVT fluid to the seal lip surfaces.

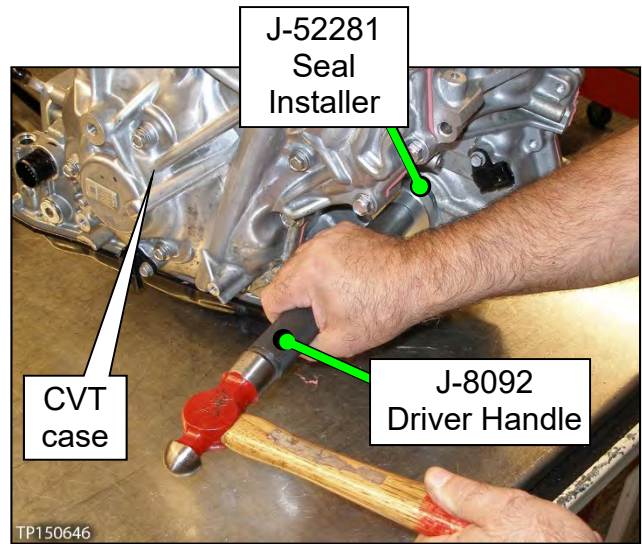

Figure 119

90. Place the CVT on the work bench with the side cover facing down on the bench.

91. Remove the converter housing, which was temporarily installed with three bolts.

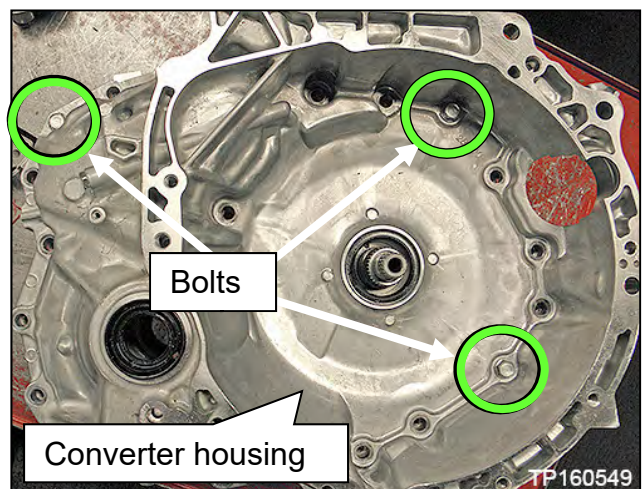

Figure 120

Clutch Total Endplay Adjustment – Thrust Bearing Selection

IMPORTANT: Using thrust bearings, the clutch total endplay (Figure 121) must always be adjusted between the clutch drum and the dummy cover when a new sub-assembly is installed.

There are eight (8) thicknesses of thrust bearings available for total endplay adjustment.

- For additional information, see video # **547: “CVT Belt and Pulley Replacement”** and fast forward to minute marker **13:22**. This video is located under the TECH TRAINING GARAGE VIDEOS tab in Virtual Academy.

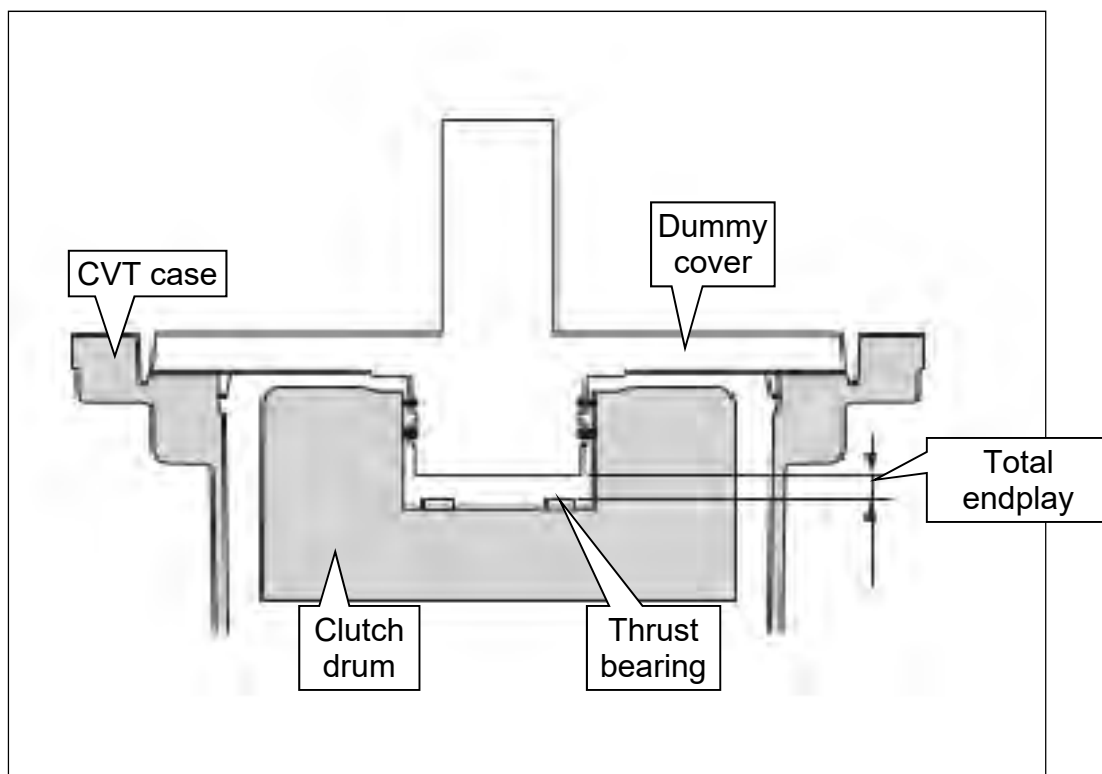

Figure 121

92. Clean and then zero the Digital Depth Gauge (part #: J-50272).
 - Set the Digital Depth Gauge to millimeters.
93. Clean Gauge Block J-50271.
94. Confirm the mating surfaces of the CVT case are clean.

95. Calculate the average (D) clutch assembly bore depth (Figure 122) as follows:

IMPORTANT: Measurements are required from two opposite ends to obtain the average.

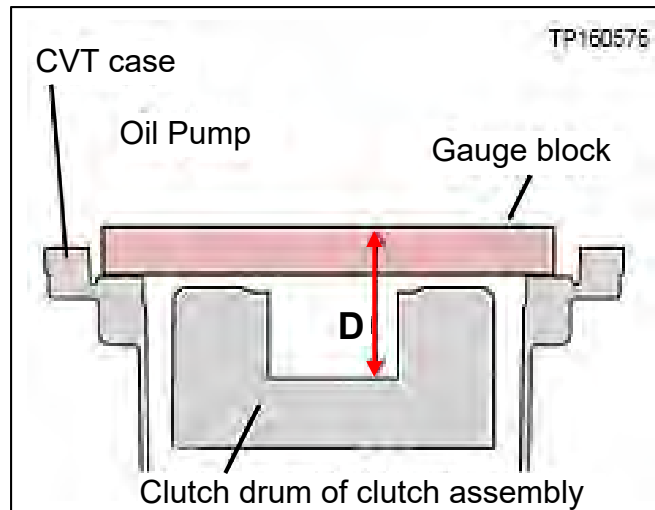

Figure 122

- a. Place the Gauge Block on the surface where the dummy cover seats and over the clutch assembly bore (Figure 123).

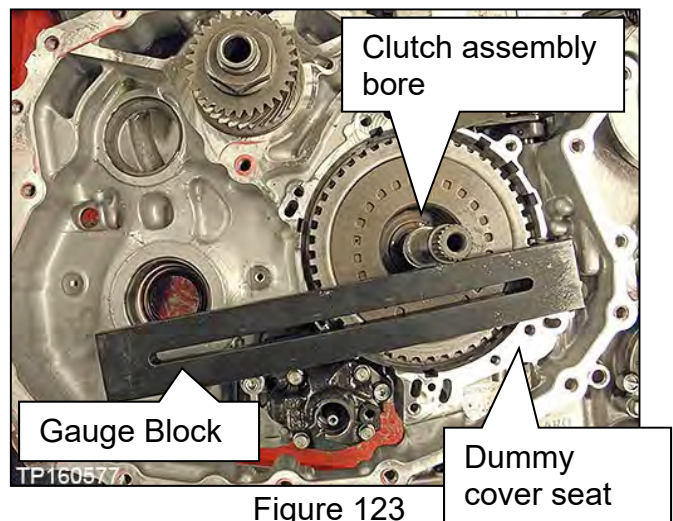

Figure 123

HINT:

- This surface is lower than the CVT case to torque converter housing surface.
- The clutch assembly should sit 2-3 mm lower than the dummy cover seat (Figure 124).

- b. Confirm the Gauge Block is not sitting on the clutch assembly or against the input shaft.

HINT: If the clutch assembly is sitting higher than the dummy cover surface, see **Dummy Cover Troubleshooting** on page 34.

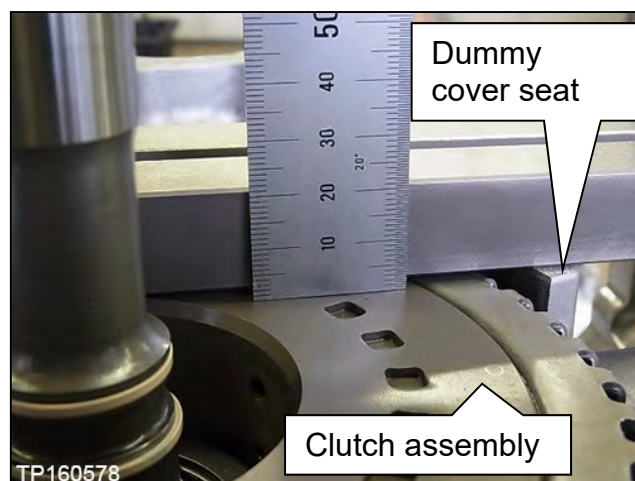

Figure 124

- c. Position the Depth Gauge on the Gauge Block (Figure 125).

HINT: Make sure the Depth Gauge's datum level is flush with the top of the Gauge Block.

- d. Carefully slide the gauge down until it bottoms out on the bottom of the clutch assembly bore. Write this measurement as **D1** (use millimeters).

HINT: Do not measure from the clutch assembly bore shown in red (Figure 126).

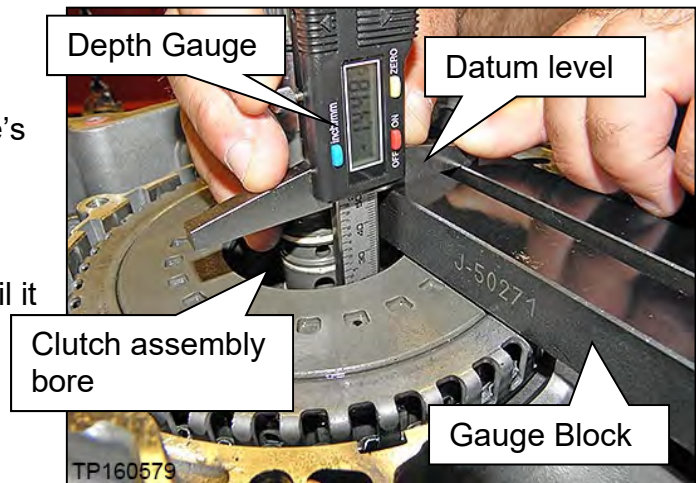

Figure 125

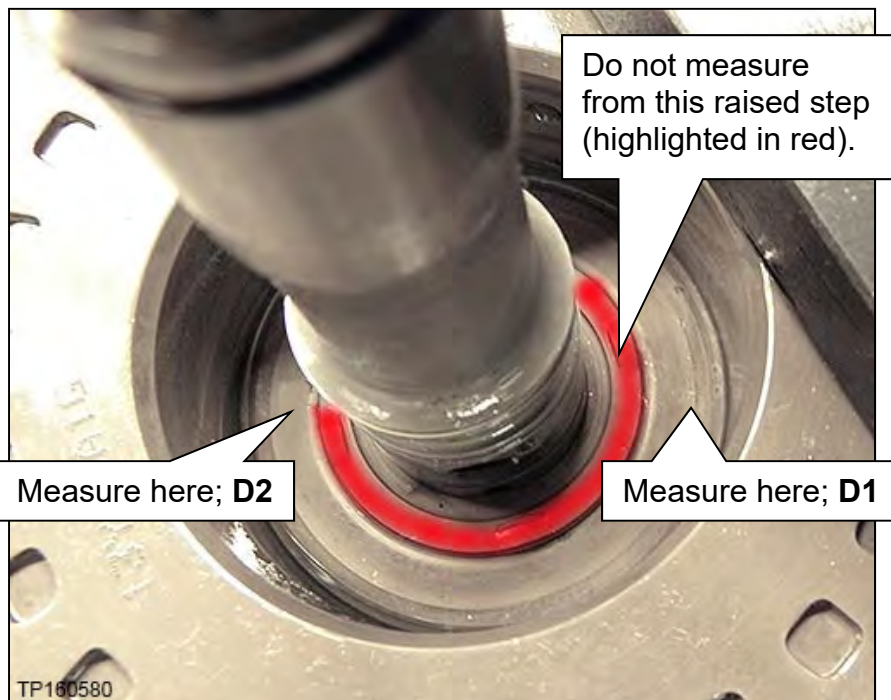

Figure 126

- e. Measure this same distance on the opposite side (180 degrees) of the clutch assembly bore and write it as **D2**.
- f. Using the formula below, calculate the average and write down the calculated value as **D**.

$$D = \frac{(D1 + D2)}{2}$$

Write the measurement for "D" here _____ mm

96. Measure the average (**H**) dummy cover height (Figure 128) as follows:

- a. Clean the dummy cover surfaces that contact the CVT case and thrust bearing (Figure 127).

IMPORTANT: Use brake cleaner (or equivalent) and a lint-free towel only. Make sure the brake cleaner or solvents used are compatible with local regulations.

- b. Place the dummy cover upside down on a work bench, and place the Gauge Block onto the thrust bearing surface (Figure 128).

- c. Position the Depth Gauge on the Gauge Block over an outer end of the dummy cover (Figure 128).

HINT: Make sure the Depth Gauge's datum level is flush with the top of the Gauge Block.

- d. Carefully slide the Depth Gauge down until it contacts the dummy cover surface that mates with the CVT case. Write this measurement as **H1** (use millimeters).
- e. Measure this same distance on the opposite side of the dummy cover and write it as **H2** (Figure 128).

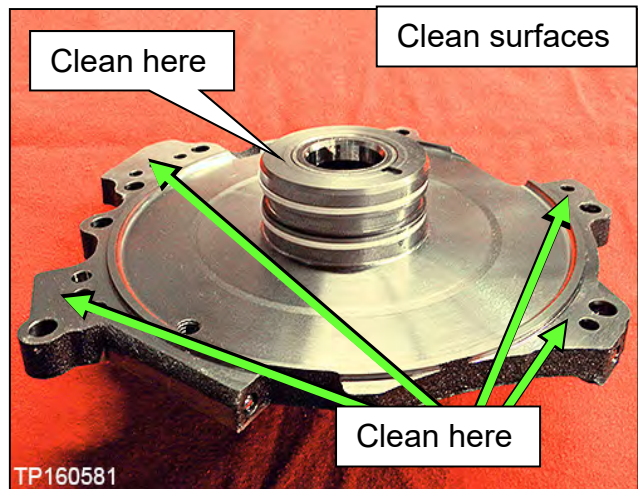

Figure 127

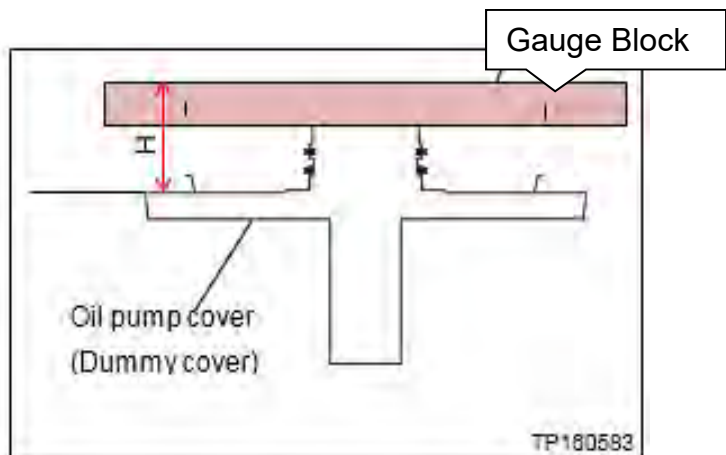
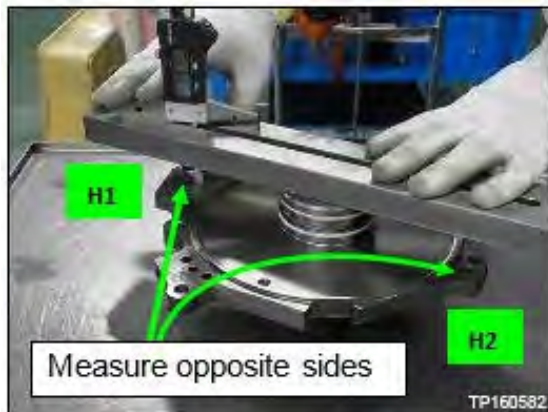

Figure 128

- f. Using the formula below, calculate the average and then write down the calculated value as **H**.

$$H = \frac{(H1 + H2)}{2}$$

Write the measurement for "H" here _____ mm

97. Choose the thrust bearing to adjust Clutch Total Endplay (A) as follows:

- a. Calculate **A** (Total Endplay):

Total Endplay A = D – H (This will be the thrust bearing thickness).

- Fill in the measurements below for "D" and "H" from pages 62 and 63 to calculate for "A".

D measurement _____ mm
 – H measurement _____ mm
 = A _____ mm

Please print this page and attach it to the repair order.

- b. Choose the appropriate bearing from **Table A** below, based on the Total Endplay (A) calculated on the previous page (8 thicknesses of thrust bearings are available).
Example: If **A** = 4.3 mm, it falls between the lower and upper clearances for bearing thickness 3.93 mm.
- Refer to the **PARTS INFORMATION** on page 95 for Thrust Bearing part numbers by thickness.
- c. Measure and confirm that the selected thrust bearing is the correct thickness before installing (Figure 129).
- d. Circle the thrust bearing part number that was selected in **Table A**.

Table A

PART #: 31407-	A = D - H CLEARANCE (A)	BEARING THICKNESS
1XZOB	3.87 - 4.07 mm	3.57
1XZ0C	4.08 - 4.23 mm	3.75
1XZ0D	4.24 - 4.43 mm	3.93
1XZ0E	4.44 - 4.58 mm	4.1
1XZ1A	4.59 - 4.78 mm	4.28
1XZ1B	4.79 - 4.94 mm	4.46
1XZ1C	4.95 - 5.09 mm	4.61
1XZ1D	5.10 - 5.29 mm	4.79



Figure 129

98. Install the thrust bearing flush to the clutch assembly bore as shown in the Figures below.

- Install the thrust bearing in the area shown in green so that it is centered by the four tabs.

HINT: The thrust bearing has two sides. See Figure 130 through Figure 133 for the correct orientation.

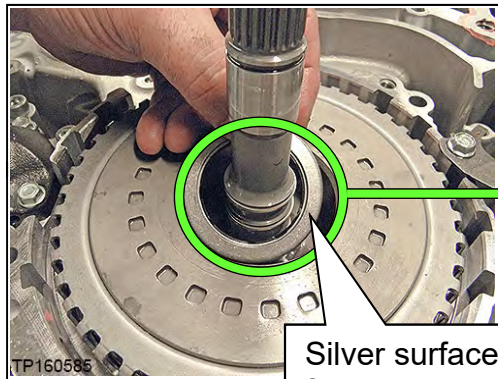

Figure 130



Figure 131

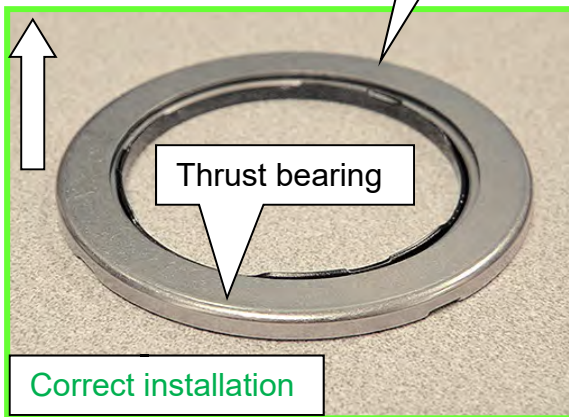

Figure 132

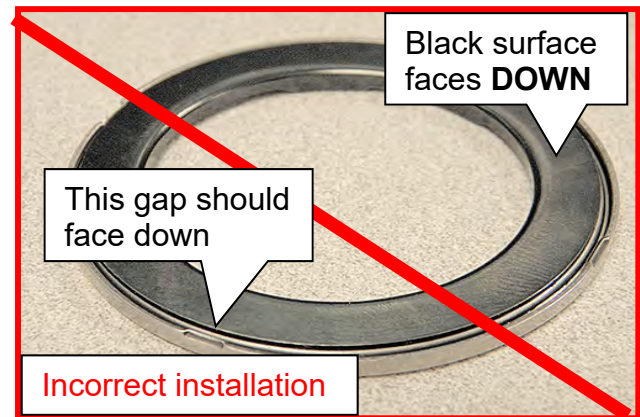

Figure 133

Clean the Converter Housing Passages

HINT: Remove as much of the CVT and cleaning fluids as possible and clean the related parts in the following steps.

99. Remove the baffle plate and lubrication tube as follows:

a. Remove the three bolts, and then remove the baffle plate from the converter housing (Figure 134).

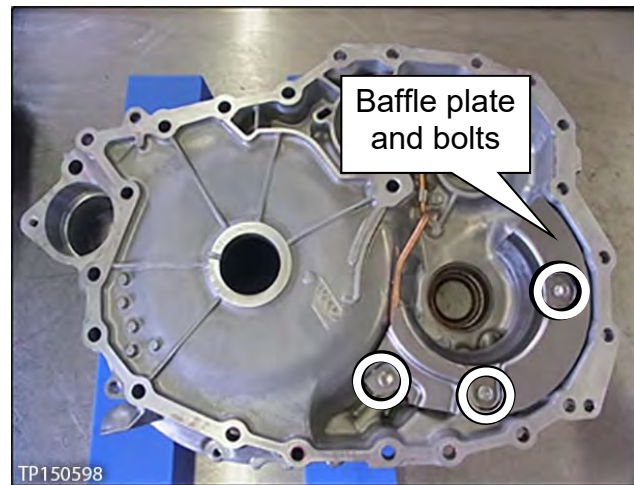

Figure 134

b. Remove the bolt and then remove the lubrication tube and its bracket (Figure 135).

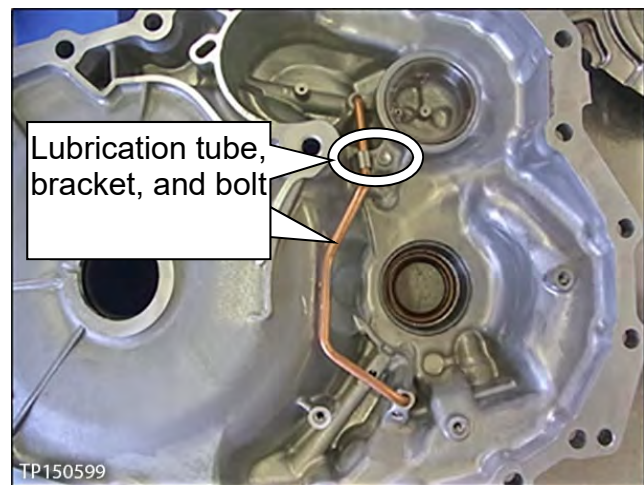

Figure 135

100. Clean the oil passages of the converter housing, lubrication tube and dummy cover with brake cleaner (or equivalent) where shown in Figure 136 through Figure 139 below.

CAUTION

To avoid being struck by debris, do not stand in front of the passages while using compressed air.

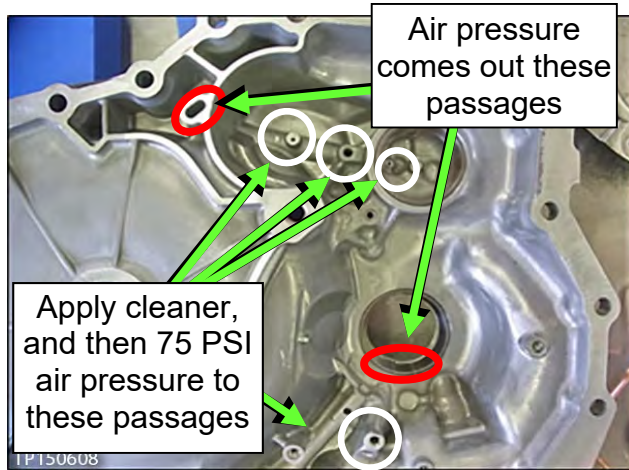

Figure 136

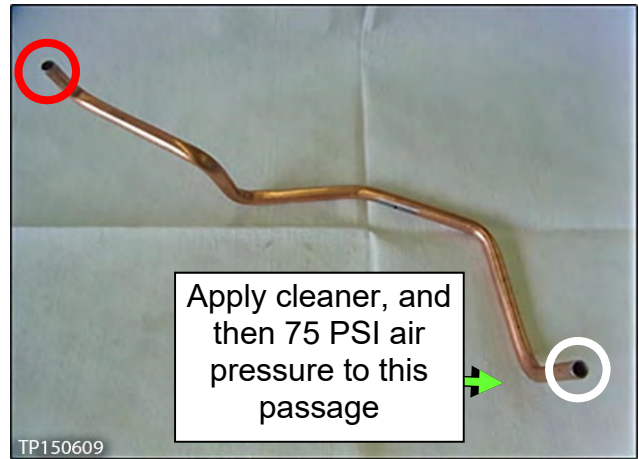

Figure 137

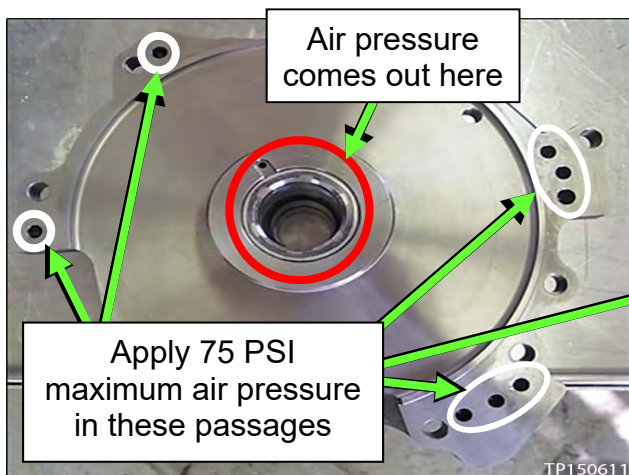

Figure 138

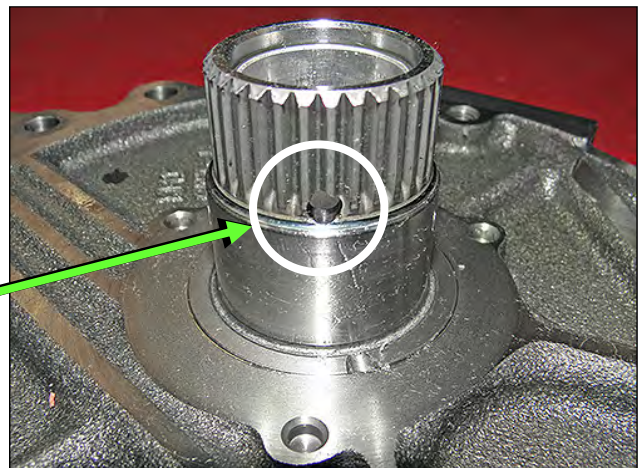

Figure 139

101. Install the lubrication tube, bracket and bolt, and then the baffle plate with three bolts (Figure 140 and Figure 141).

- Bolt torque: 5.9 N•m (0.6kg-m, **52 in-lb.**)

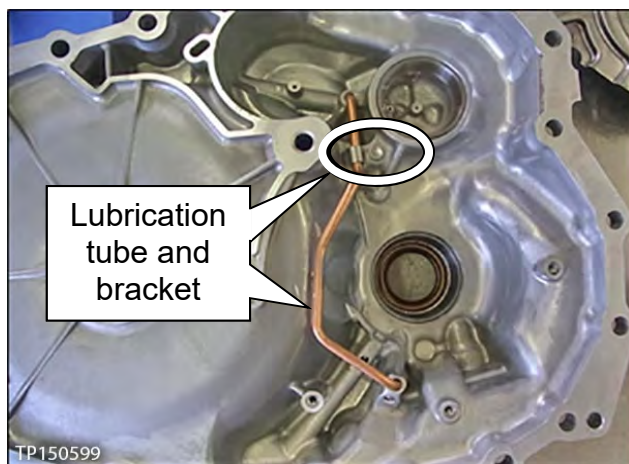

Figure 140

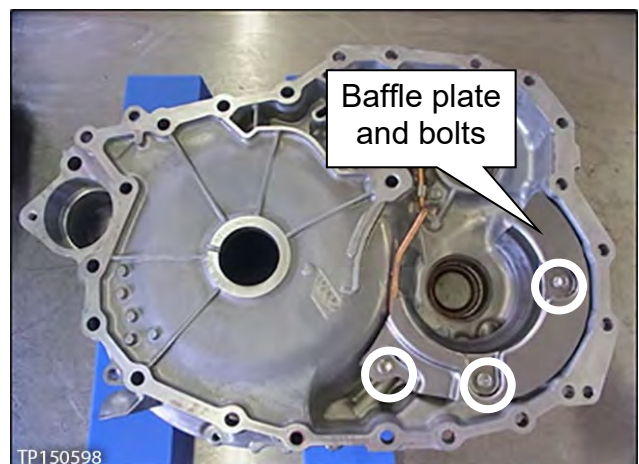

Figure 141

CVT Reassembly

102. Install the torque converter housing side axle seal (Figure 142) on FWD vehicles. For AWD vehicles, skip to step 104.

- Place the torque converter housing flat during installation.
- Apply a light coat of CVT fluid to the seal lip surfaces.
- The torque converter housing seal will be 0.5 mm (**0.020 inches**) below the bore's surface when the seal installer bottoms out.



Figure 142

103. Install the torque converter housing side axle seal (Figure 143).

- Use Seal Installer J-52282 and Driver Handle J-8092.
- Apply a light coat of CVT fluid to the seal lip surfaces.

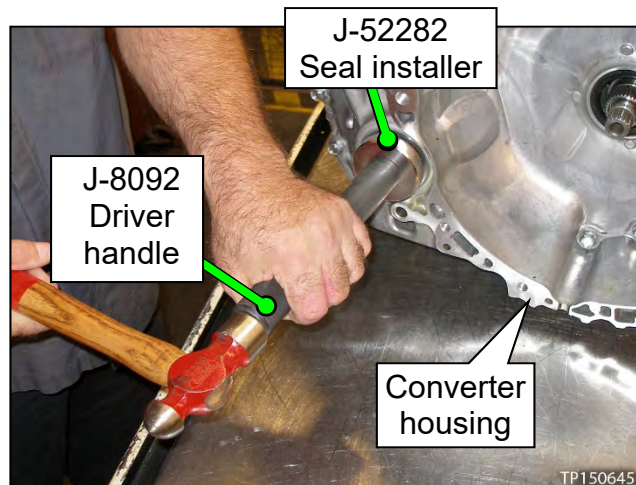

Figure 143

104. Apply petroleum jelly or equivalent to the dummy cover's lathe cut seals (Figure 144) before installing the dummy cover to the CVT case.

NOTICE

To prevent drivability issues, confirm that the lathe cut seals (white seals) are in their appropriate slots. Carefully reposition the seals as necessary.

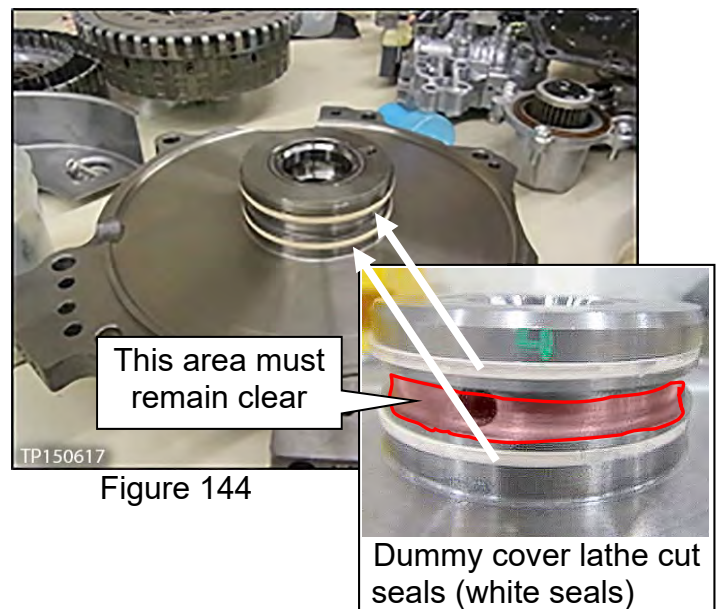

Figure 144

105. Confirm that the input shaft's lathe cut seals are in the correct positions (Figure 145).

NOTICE

To prevent drivability issues, confirm that the lathe cut seals (white seals) are in their appropriate slots. Carefully reposition the seals as necessary.

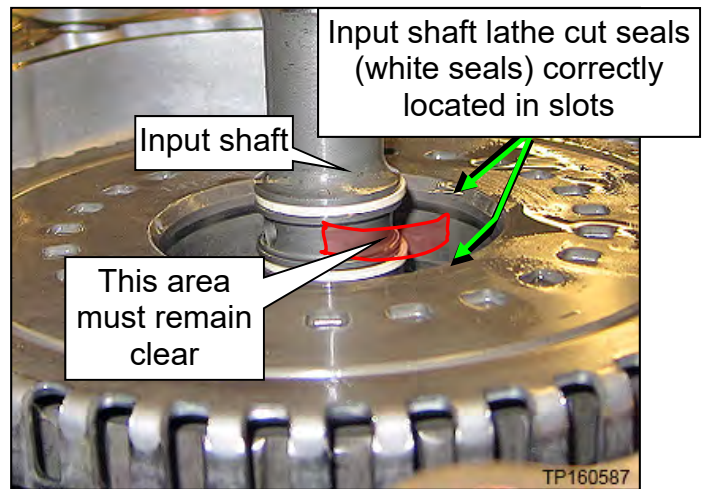

Figure 145

106. Install the dummy cover first, then baffle plate C, and then the related bolts finger tight (Figure 146).

IMPORTANT: Visually check that the dummy cover is fully seated on the CVT case. If it is not, refer to **Dummy Cover Troubleshooting** on page 34.

- Do not force the dummy cover into place.
- Make sure the dummy cover is fully seated before installing the bolts.
- Do not torque these bolts at this time.

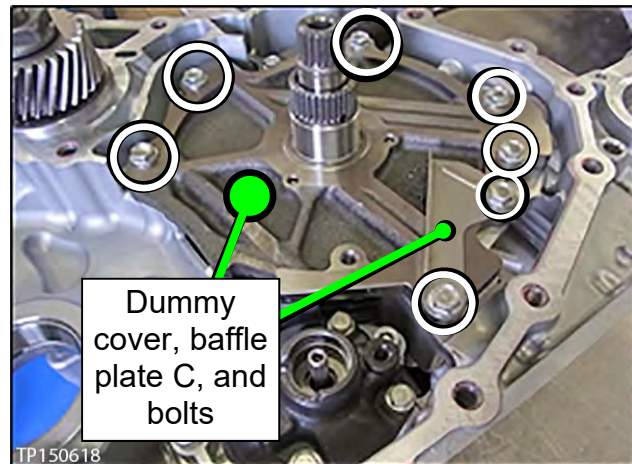

Figure 146

107. Install baffle plate B and "L" bracket with the related bolts finger tight (Figure 147).

108. Torque the bolts from steps 106 and 107 in the following order:
- a. Baffle plate B bolts: 5.9 N•m (0.6 kg-m, **52.2 in-lb.**)
 - b. "L" bracket bolts: 25.5 N•m (2.6 kg-m, 19 ft-lb). Torque 1 **1** then 2 **2**
 - c. Dummy cover and baffle plate C bolts torque: 19.0 N•m (1.9 kg-m, **14 ft-lb.**)

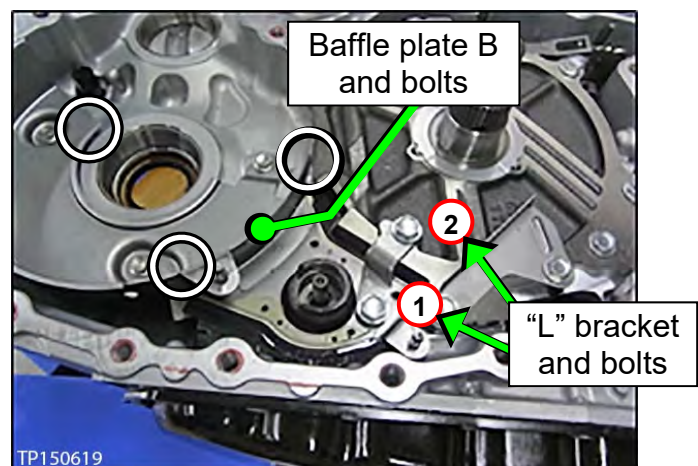

Figure 147

109. Install the thrust washer onto the dummy over (Figure 148).
- Use petroleum jelly or equivalent to hold the thrust washer in place.
 - Make sure the tabs fit into the holes.

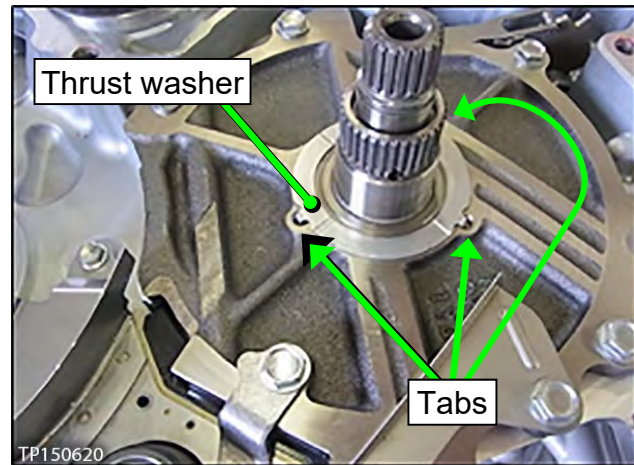

Figure 148

110. Install the drive sprocket, driven sprocket, and chain as an assembly (Figure 149).

- Make sure the raised edge (wider edge) on the drive sprocket is facing up (Figure 150).

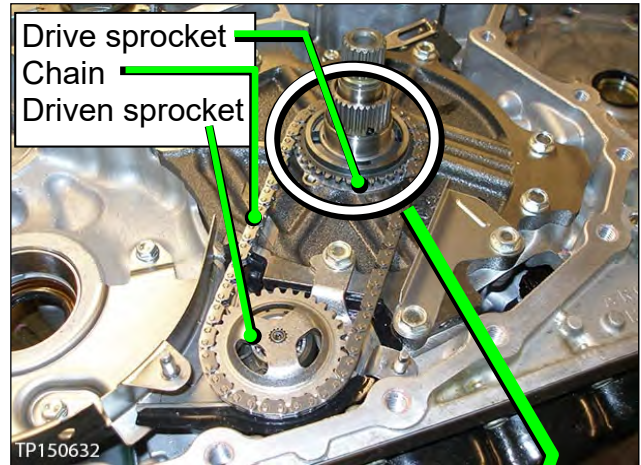

Figure 149



Figure 150

- Expand the snap ring with a suitable tool, and then push down on the driven sprocket until it bottoms out (Figure 151).
- Release the snap ring and then pull up on the driven sprocket until the snap ring locks into its groove.

HINT: A click sound is heard when the snap ring locks in place.

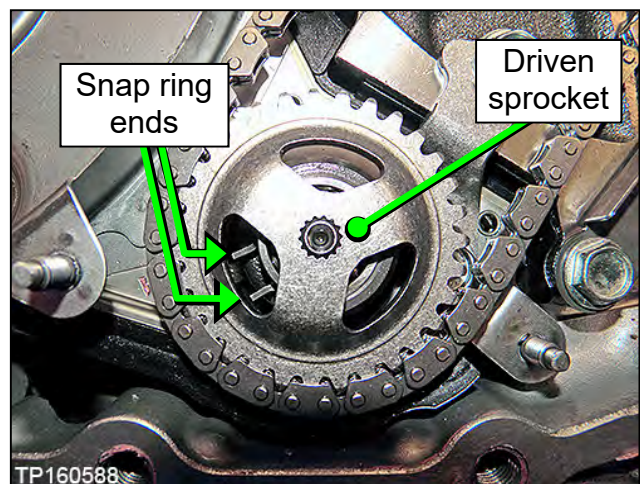

Figure 151

111. Install baffle plate A with two nuts (Figure 152).

- Nut torque: 5.9 N•m (0.6 kg-m, **52.2 in-lb.**)

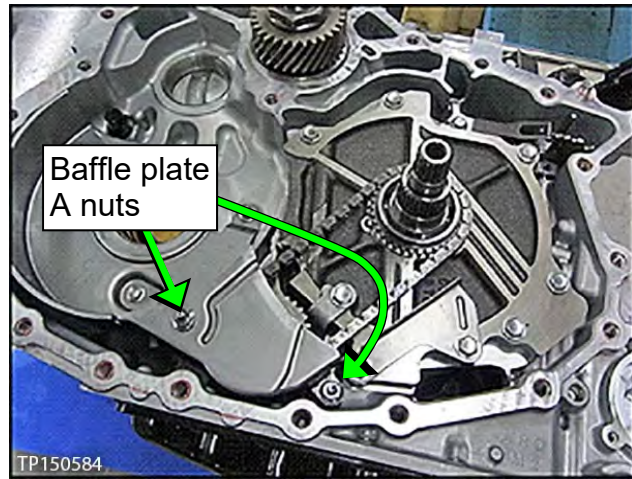

Figure 152

112. Install a new O-ring on the input shaft (Figure 153).

- Apply CVT fluid to the O-ring and O-ring groove before installing.

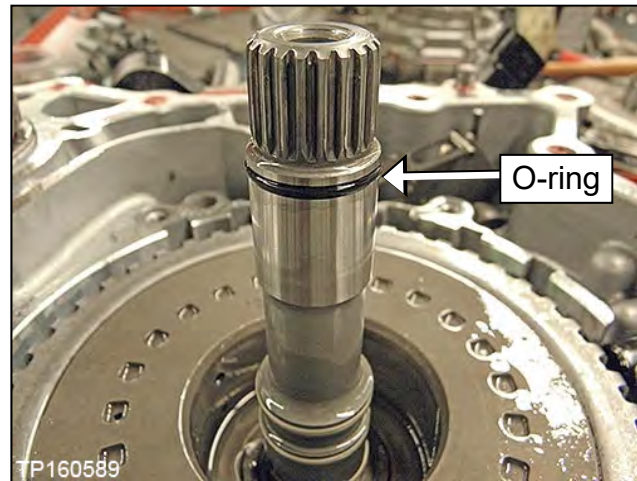

Figure 153

113. Install the differential assembly and the reduction gear assembly into the CVT case (Figure 154 and Figure 155).

- Thoroughly clean each assembly before installing.
- Oil the bearings and gear teeth with CVT fluid before installing.

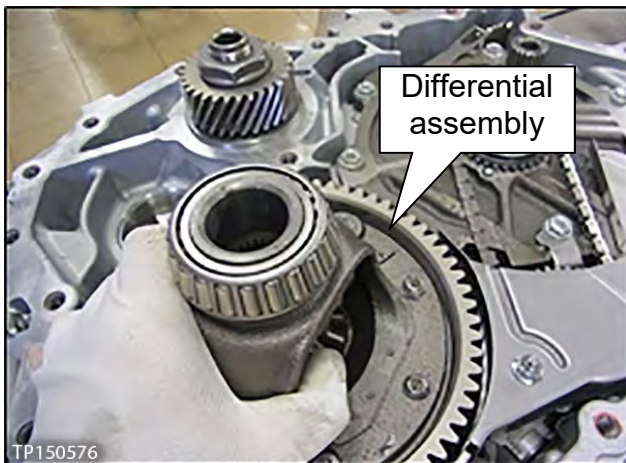

Figure 154

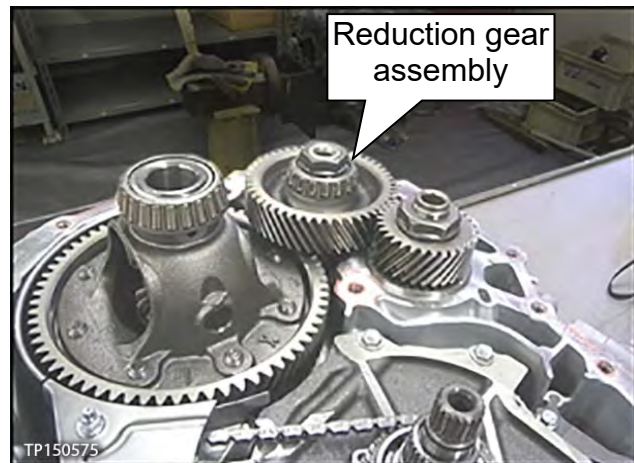

Figure 155

114. Install the CVT fluid filter and components (Figure 156 and Figure 157).

- Install a new filter with grommet (one part).
- Install a new O-ring.
- Confirm that all components and areas where components fit are thoroughly clean.
- Apply CVT fluid to the grommet seal and O-ring before installing.
- Install the filter cover.
 - Bolt torque 4.2 N•m (0.43 kg-m, **37.2 in-lb.**)

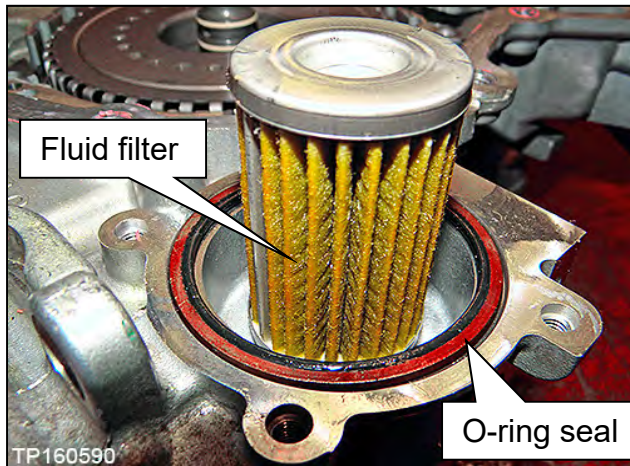

Figure 156

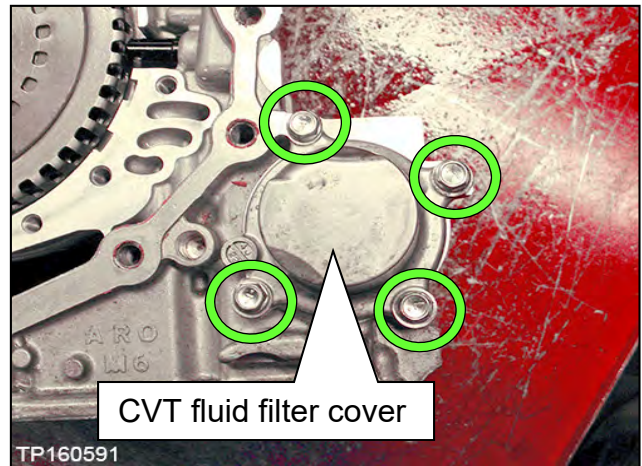

Figure 157

115. Confirm the pin (Figure 158) is located in the CVT case prior to installation of the converter housing.

HINT: Apply petroleum jelly or equivalent to keep it in place if necessary.

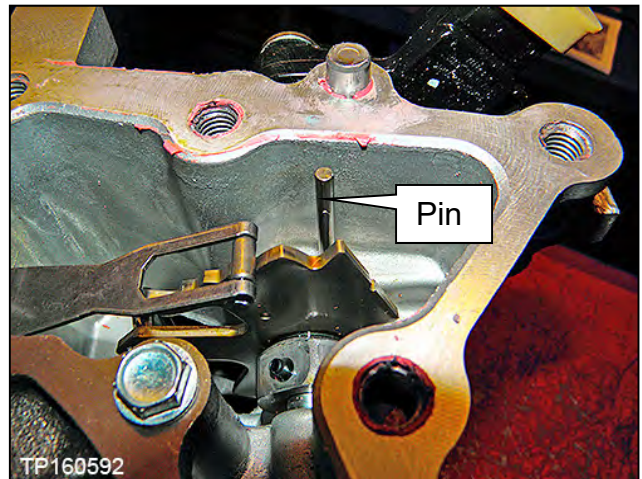

Figure 158

116. Apply one continuous, 2.0 mm (**0.8 inches**) diameter, bead (Figure 159) of pink colored Loctite 5460 Sealant (see **PARTS INFORMATION** on page 95).

- Before sealant application, make sure the mating surfaces are clean from oil, dirt, old sealant, etc. (Figure 159).

HINT: Have the converter housing ready for installation prior to applying the sealant.

HINT:

- Start applying sealant where shown, making sure that the starting point and the ending point are between two bolt holes.
- Overlap both ends of the bead by 3-5 mm (**0.12-0.20 inches**).
- Make sure to apply sealant around the center bolt hole.

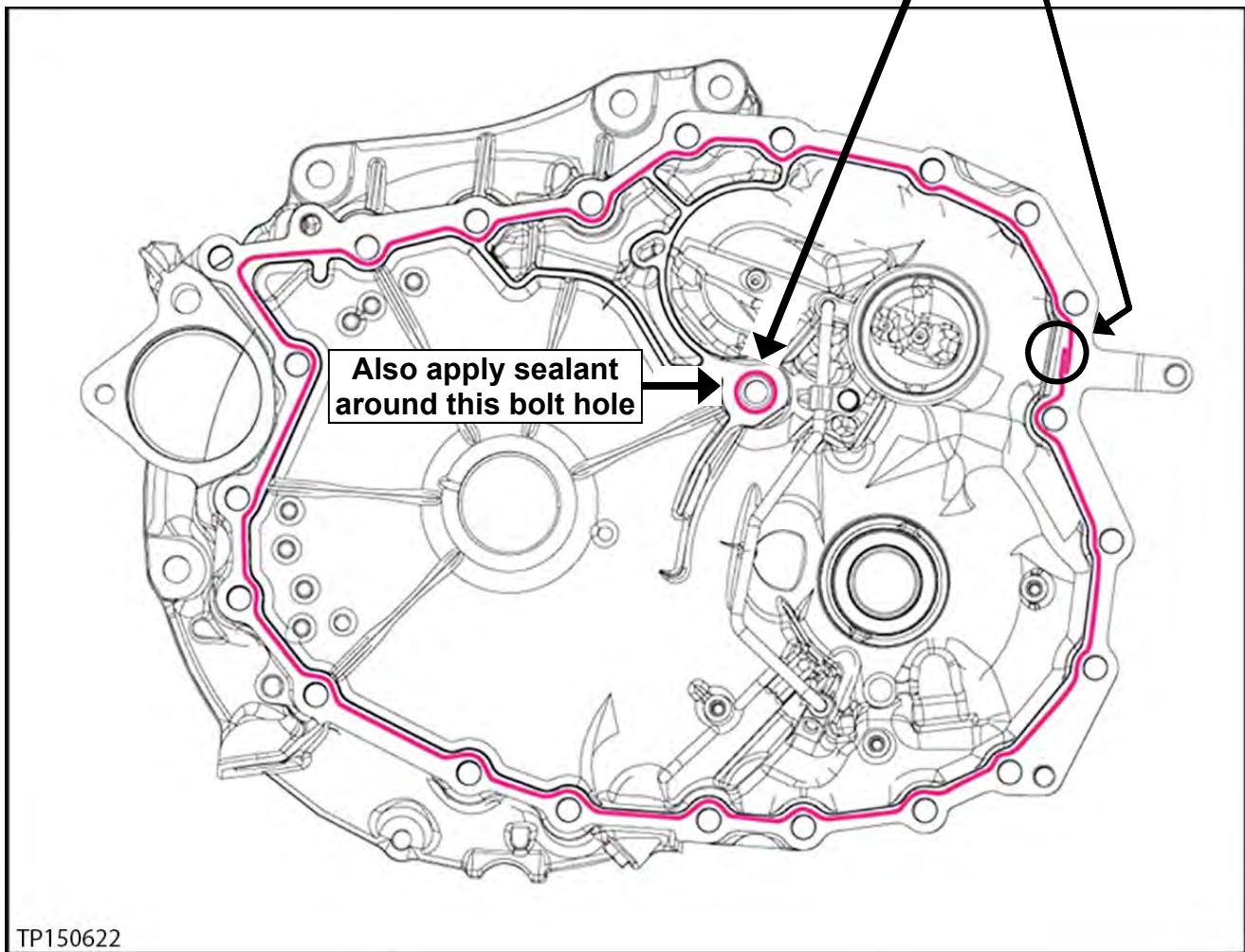





Figure 159

117. Install the converter housing onto the CVT case (see Figure 160 for torque sequence):

- Install the 23 new bolts.
 - a. Torque the first six (6) bolts with symbol  in numbered sequence (see below).
 - b. Torque the remaining bolts with symbol  in numbered sequence (see below).
 - Use a short socket on the bolts indicated by this symbol: 
 - All bolts are 30 mm (1.2 inches) in length.
 - Bolt torque: 45.0 N•m (4.6 kg-m, 33.2 ft-lb.)
 - Make sure to torque the bolts in the sequence shown in (Figure 160), below.

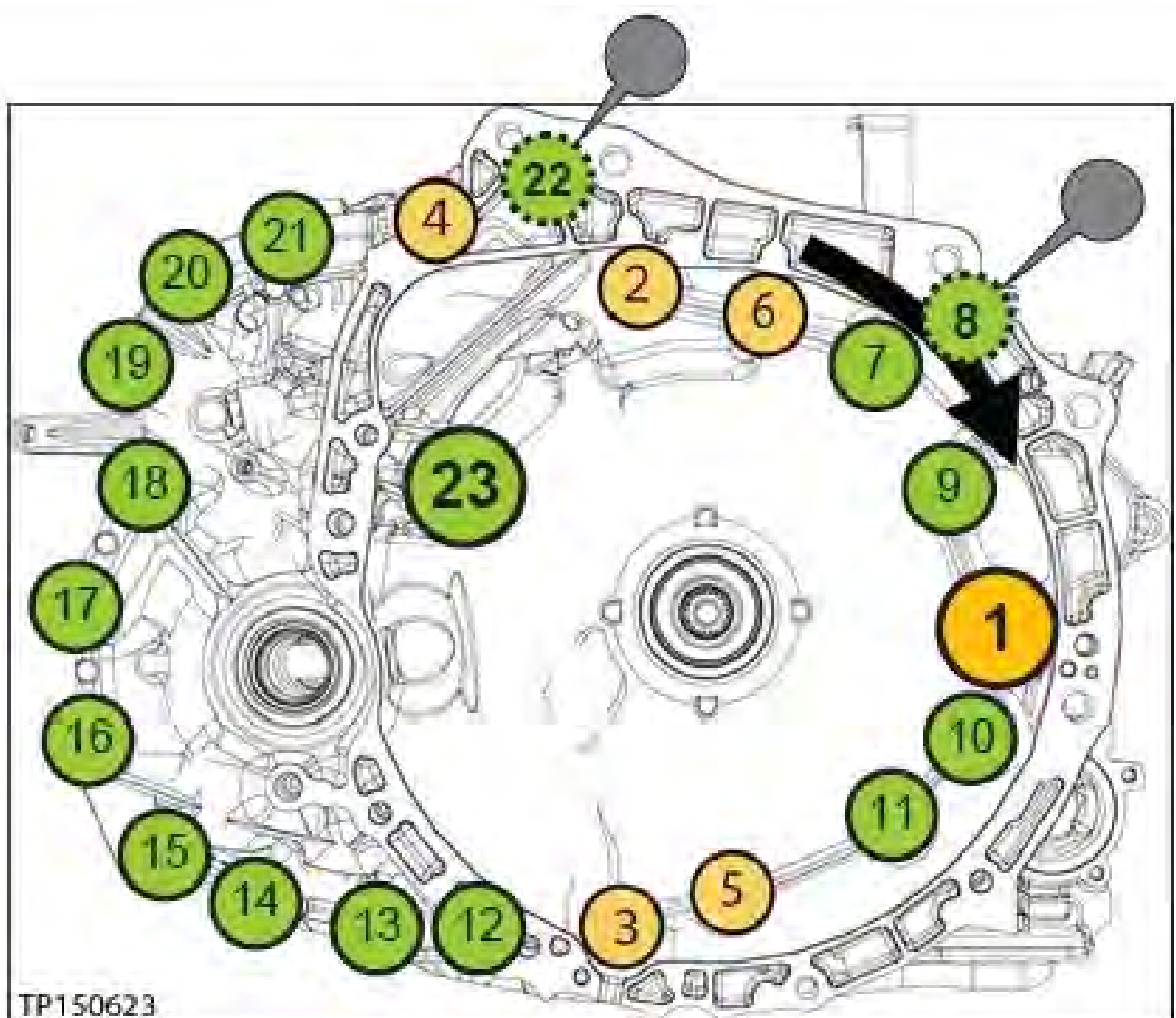

Figure 160

118. Clean off the excess sealant.

Control Valve, Strainer, and Pan Installation

NOTICE

To avoid introducing debris into the CVT hydraulic system on vehicles that have an external CVT cooler, **a cooler flush is required** after a valve body or CVT assembly replacement.

- For the procedure to flush the CVT cooler, refer to the ESM, section:
**TRANSMISSION & DRIVELINE > TRANSAXLE & TRANSMISSION > CVT:
RE0F10D > BASIC INSPECTION > CVT FLUID COOLER SYSTEM > CLEANING.**

HINT:

- Installation steps in this bulletin may contain different style parts than what were originally installed in the CVT. Pay careful attention, REASSEMBLY MAY NOT BE IDENTICAL TO DISASSEMBLY.
- **Confirm that the QR label, control valve and CD part numbers all match before installing the control valve** (refer to NTB12-103).
- For additional information, see video # 547: “CVT Belt and Pulley Replacement” and fast forward to minute marker 20:09. This video is located under the TECH TRAINING GARAGE VIDEOS tab in Virtual Academy.

HINT: If an oil strainer bracket was removed, do not reinstall it. An oil strainer bracket (Figure 161) will not be used with the new oil strainer.

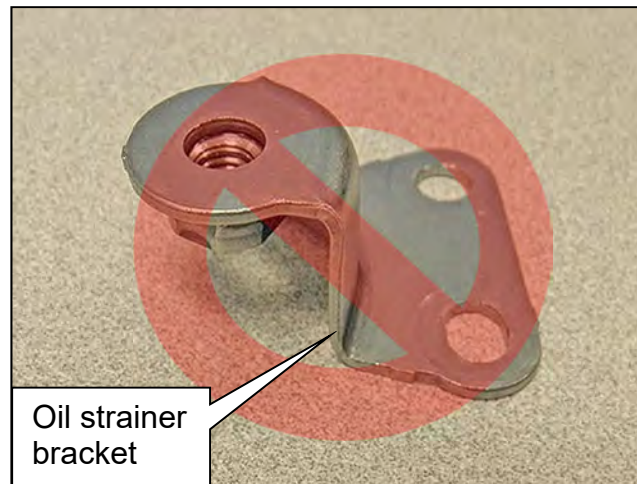

Figure 161

119. Install a new lip seal (Figure 162).

- Do NOT reuse the old lip seal.
- Apply a small amount of petroleum jelly or equivalent to the lip seal to keep it in place on the CVT.

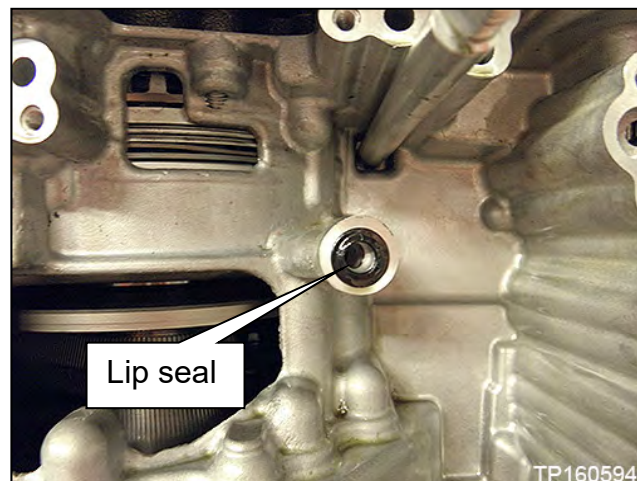

Figure 162

120. Install the Control Valve with eleven (11) mounting bolts (Figure 163).

IMPORTANT:

- Leave four (4) ✘ bolt holes empty at this step.
- Make sure the wiring harness is not pinched (see Figure 164 and Figure 165 for correct routing).
- 54 mm (2.125 inches) long bolt ●; 7 pieces
- 44 mm (1.73 inch) long bolt ●; 2 pieces
- 25 mm (1 inch) long bolt ●; 2 pieces

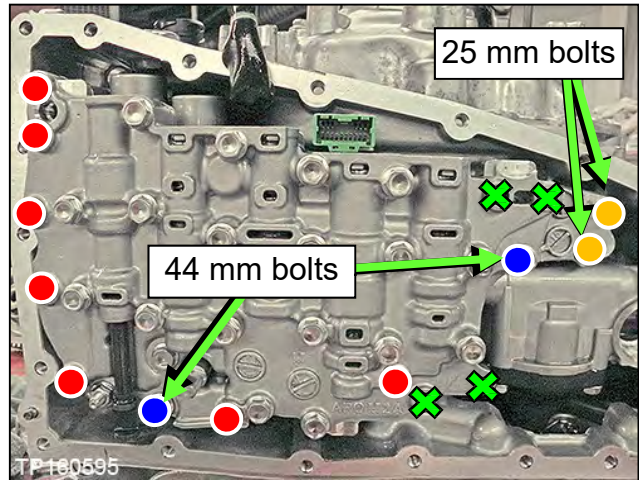

Figure 163

HINT: The two 25 mm bolts are installed WITHOUT the strainer bracket.

- Bolt torque: 7.9 N•m (0.81 kg-m, 70 in-lb.)

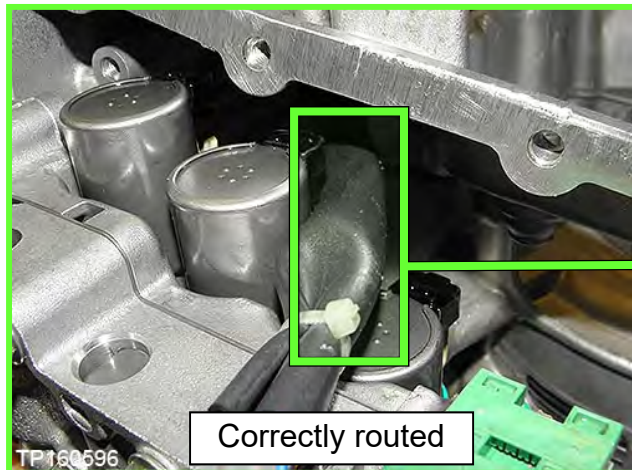

Figure 164

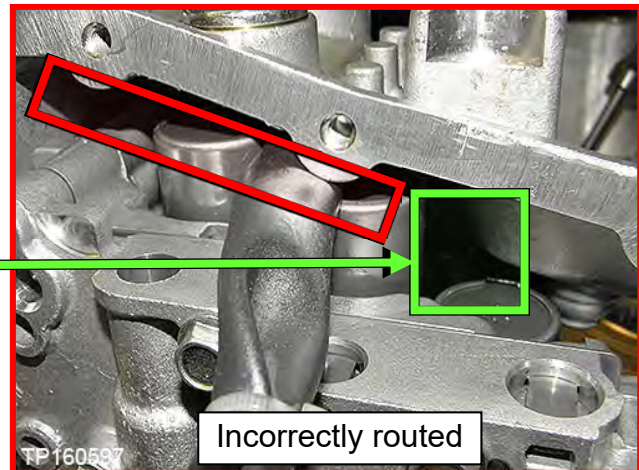

Figure 165

121. Replace the metal bracket of the fluid temperature sensor as follows:

HINT: The new bracket will be oriented the same way the old bracket was.

- a. Cut the old plastic zip tie with an appropriate tool to remove the fluid temperature sensor's metal bracket from the terminal harness assembly (Figure 166 and Figure 167).

NOTICE

Cut the plastic zip tie over the metal bracket to avoid damage to the fluid temperature sensor.

- b. Use the new plastic zip tie from the **PARTS INFORMATION** on page 95 to attach the fluid temperature sensor of the terminal connector harness to the fluid temperature sensor's new metal bracket.

IMPORTANT:

- Secure the plastic zip tie at the center notch of three notches on the fluid temperature sensor (Figure 166).
 - Tighten the plastic zip tie so that it is oriented as shown in Figure 167.
- c. Cut off the plastic zip tie excess.

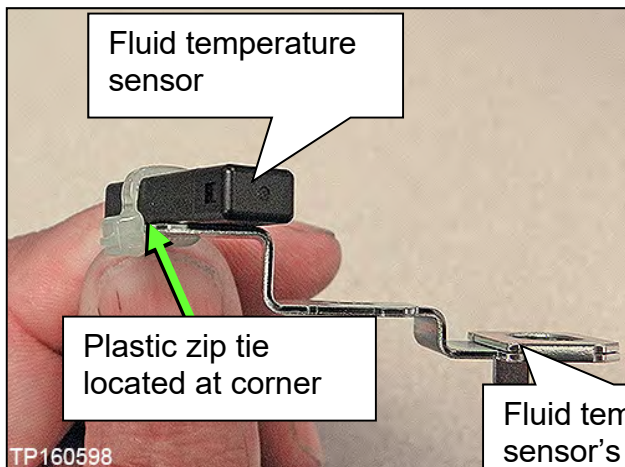

Figure 166

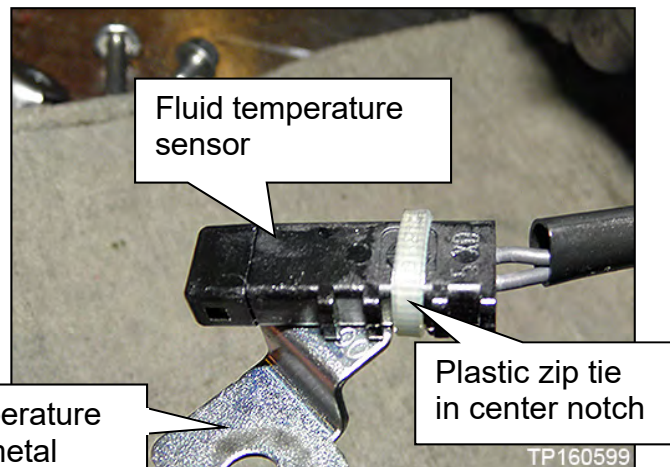

Figure 167

122. Connect the electrical harness connector (Figure 168).

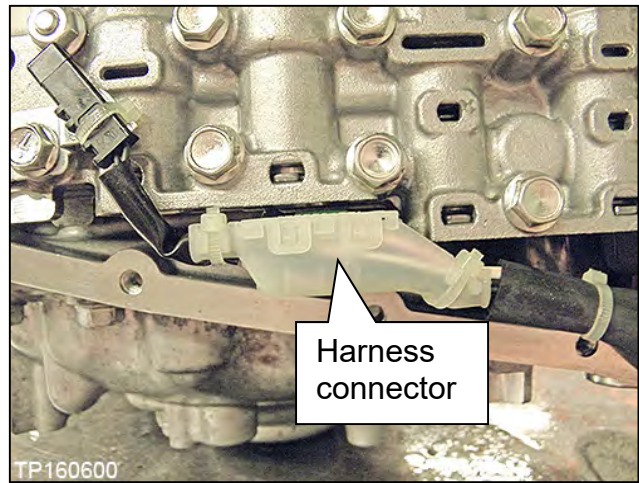

Figure 168

123. Install the CVT fluid temperature sensor bracket to the control valve with one (1) bolt (Figure 169).

HINT: Leave one (1) bolt hole empty as it will be used to secure the oil strainer at a later step.

- 54 mm (2.125 inches) long bolt.
 - Bolt torque: 7.9 N•m (0.81 kg-m, 70 in-lb.)

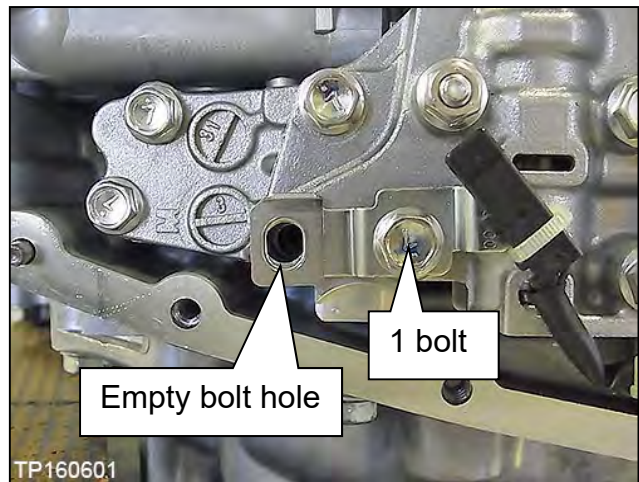



Figure 169

124. Install the new oil strainer with its new O-ring seal with two (2) bolts (Figure 170).

HINT: The replacement strainer maybe a different shape than the original.

- 54 mm (2.125 inches) long bolt ; 2 pieces.
 - Bolt torque: 7.9 N•m (0.81 kg-m, 70 in-lb.)

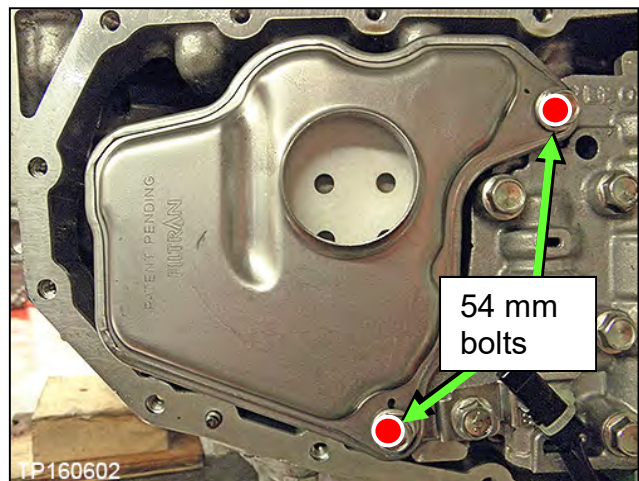

Figure 170

125. Install the manual plate, lock washer, and nut (Figure 171).

HINT: Make sure the manual plate fits into the slot of the manual valve before applying torque to the nut.

- Reuse the existing manual plate, lock washer, and nut.
 - Nut torque: 22.1 N•m (2.3 kg-m, **16 ft-lb.**)

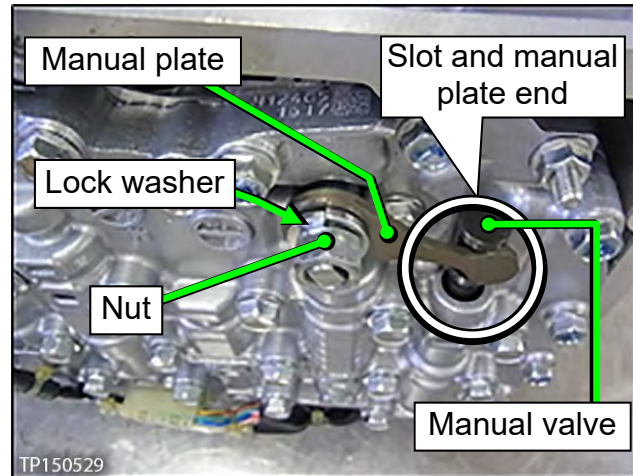

Figure 171

126. Clean the original oil pan and magnets with a suitable cleaner. Visible debris should not be present during reassembly.

127. Reassemble the original magnets to their original locations on the oil pan.

128. Install a new oil pan gasket to the oil pan.

129. Install the oil pan bolts (see Figure 172).

- Reuse the existing oil pan bolts.
 - Oil pan bolt torque: 7.9 N•m (0.81 kg-m, **70 in-lb.**)

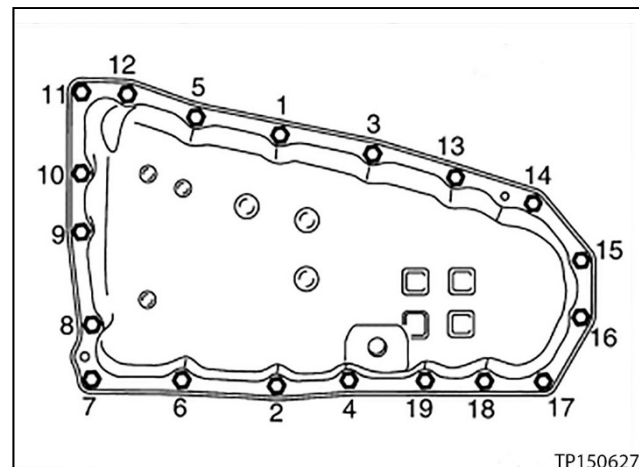

Figure 172

130. Install a new drain plug washer to the drain plug on the oil pan.

131. Fill the CVT assembly with NS-3 CVT fluid or equivalent.

- For the procedure to fill CVT with NS-3 CVT fluid or equivalent, refer to the ESM, section **TRANSMISSION & DRIVELINE > TRANSAXLE & TRANSMISSION > CVT: RE0F10D > PERIODIC MAINTENANCE > CVT FLUID.**

NOTICE

To avoid introducing debris into the CVT hydraulic system on vehicles that have an external CVT cooler, **a cooler flush is required** after a valve body or CVT assembly replacement.

- For the procedure to flush the CVT cooler, refer to the ESM, section **TRANSMISSION & DRIVELINE > TRANSAXLE & TRANSMISSION > CVT: RE0F10D > BASIC INSPECTION > CVT FLUID COOLER SYSTEM > CLEANING.**

132. Install the primary speed sensor to the CVT assembly.

HINT: Install a new O-ring to the speed sensor before installation. DO NOT reuse the old O-ring.

➤ Bolt torque: 5.9 N•m (0.6 kg-m, **52 in-lb.**)

133. Install the torque converter to the CVT assembly.

- Verify the torque converter is installed at the proper depth (see Figure 173).
- **A** = 14.4 mm

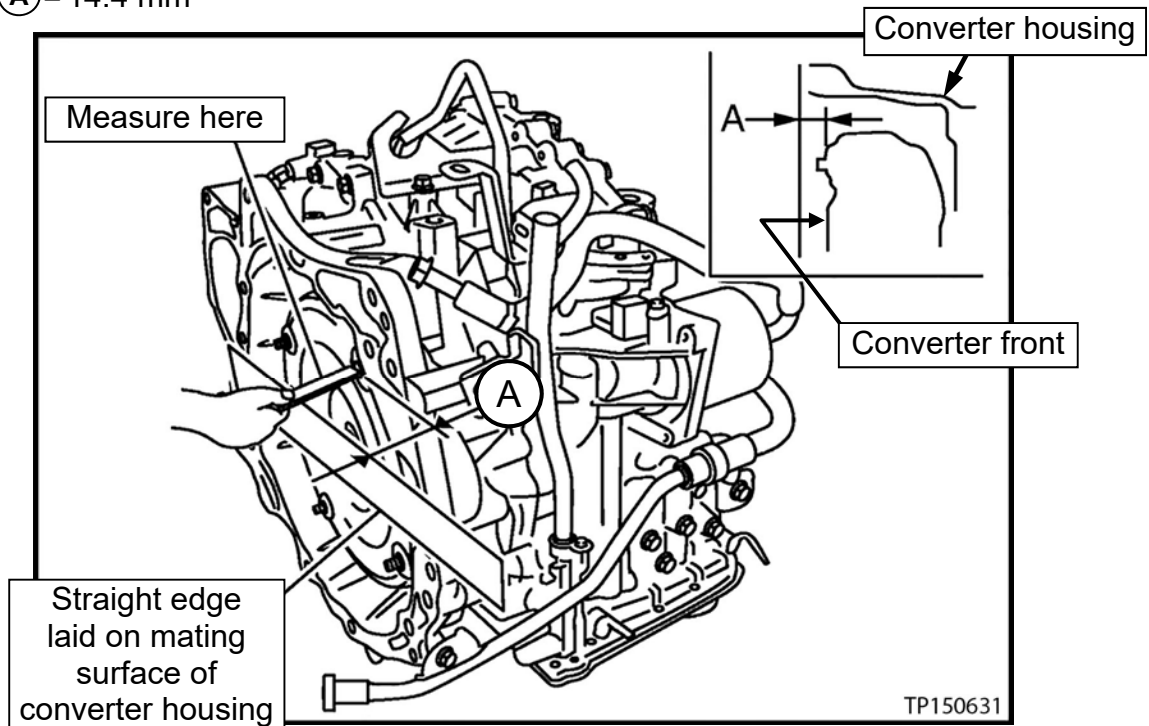

Figure 173

134. Attach the QR label (Figure 174) with the new calibration data onto the transmission range switch (inhibitor switch; Figure 175).

- A QR Label and CD-R are included with the new control valve.

135. Confirm that the QR label and the CD-R part numbers are the same (Figure 175).

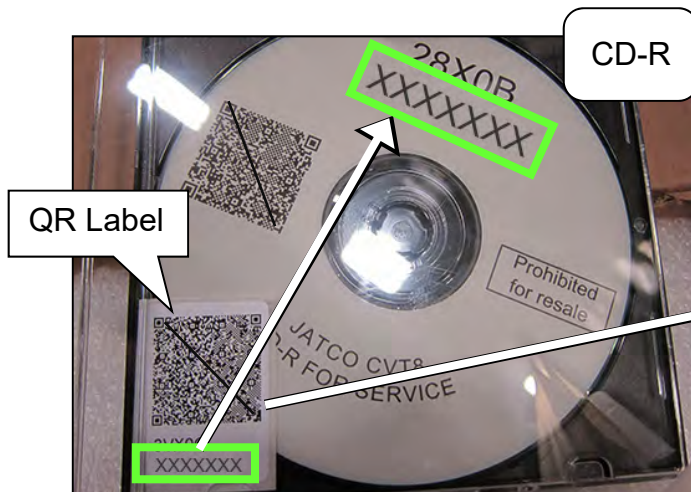

Figure 174

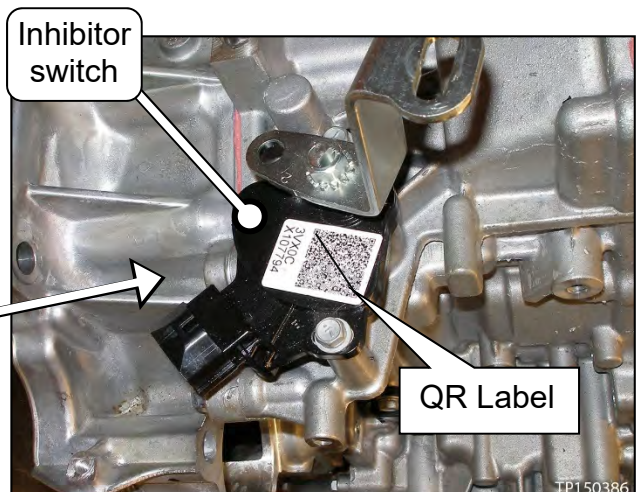

Figure 175

Install the CVT Assembly

136. Install the CVT assembly into the vehicle.

HINT: For CVT installation, refer to the ESM, section **TRANSMISSION & DRIVELINE - TRANSAXLE & TRANSMISSION - CVT: RE0F10D - UNIT REMOVAL AND INSTALLATION - TRANSAXLE ASSEMBLY**

And then,

- 2WD vehicles skip to step 137 below.
- All-wheel drive vehicles, install the transfer case as follows:
 1. Replace only the external O-ring to the transfer case and then install the transfer case to the CVT.
 2. Apply CVT fluid to the O-ring.

HINT:

- Refer to the ESM, section **Driveline**, for the transfer case assembly installation.
- Use extreme caution when installing the axle to the transfer case assembly to avoid seal damage or deformation.
- Properly support and guide the axle.

3. Proceed to step 137.

137. Flush the CVT cooler.

NOTICE

To avoid introducing debris into the CVT hydraulic system on vehicles that have an external CVT cooler, **a cooler flush is required** after a valve body or CVT assembly replacement.

- For the procedure to flush the CVT cooler, refer to the ESM, section:

TRANSMISSION & DRIVELINE > TRANSAXLE & TRANSMISSION > CVT: RE0F10D > BASIC INSPECTION > CVT FLUID COOLER SYSTEM > CLEANING.

138. Connect both battery cables, negative cable last.

139. Reset/reinitialize systems as needed.

- Refer to the ESM for a listing of systems that require reset/initialization after reconnecting the 12V battery:

ELECTRICAL & POWER CONTROL > POWER SUPPLY, GROUND & CIRCUIT ELEMENTS > BASIC INSPECTION > INSPECTION AND ADJUSTMENT > ADDITIONAL SERVICE WHEN REMOVING BATTERY NEGATIVE TERMINAL

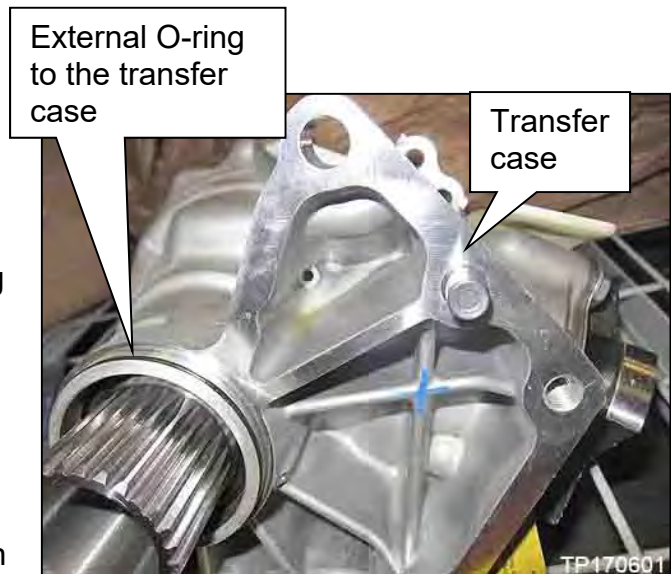

Figure 176

TCM Reprogramming

IMPORTANT: Repairs performed for this bulletin require CONSULT-III plus (C-III plus) Diagnostic result reporting function-Setting be turned ON and Diagnosis (All Systems) be performed. If not done, it may result in a repair being non-warrantable.

IMPORTANT: Before starting, make sure:

- ASIST on the CONSULT PC has been synchronized (updated) to the current date.
- All C-III plus software updates (if any) have been installed.
- The CONSULT PC is connected to the Internet (Wi-Fi or cable).

NOTE:

- Most instructions for reprogramming with C-III plus are displayed on the CONSULT PC screen.
- If you are not familiar with the reprogramming procedure, [click here](#). This will link you to the "CONSULT- III plus (C-III plus) Reprogramming" general procedure.

CAUTION:

- Connect a battery maintainer or smart charger set to reflash mode or a similar setting. If the vehicle battery voltage drops below 12.0V or rises above 15.5V during reprogramming, the TCM may be damaged.
- Be sure to turn OFF all vehicle electrical loads. If a vehicle electrical load remains ON, the TCM may be damaged.
- Be sure to connect the AC Adapter. If the CONSULT PC battery voltage drops during reprogramming, the process will be interrupted and the TCM may be damaged.
- Turn OFF all external Bluetooth® devices (e.g., cell phones, printers, etc.) within range of the CONSULT PC and the plus VI. If Bluetooth® signal waves are within range of the CONSULT PC or plus VI during reprogramming, reprogramming may be interrupted and the TCM may be damaged.

140. Connect the CONSULT PC to the vehicle.

141. Start C-III plus.

142. Wait for the plus VI to be recognized.

- The serial number will display when the plus VI is recognized.

143. Select **Re/programming, Configuration**.

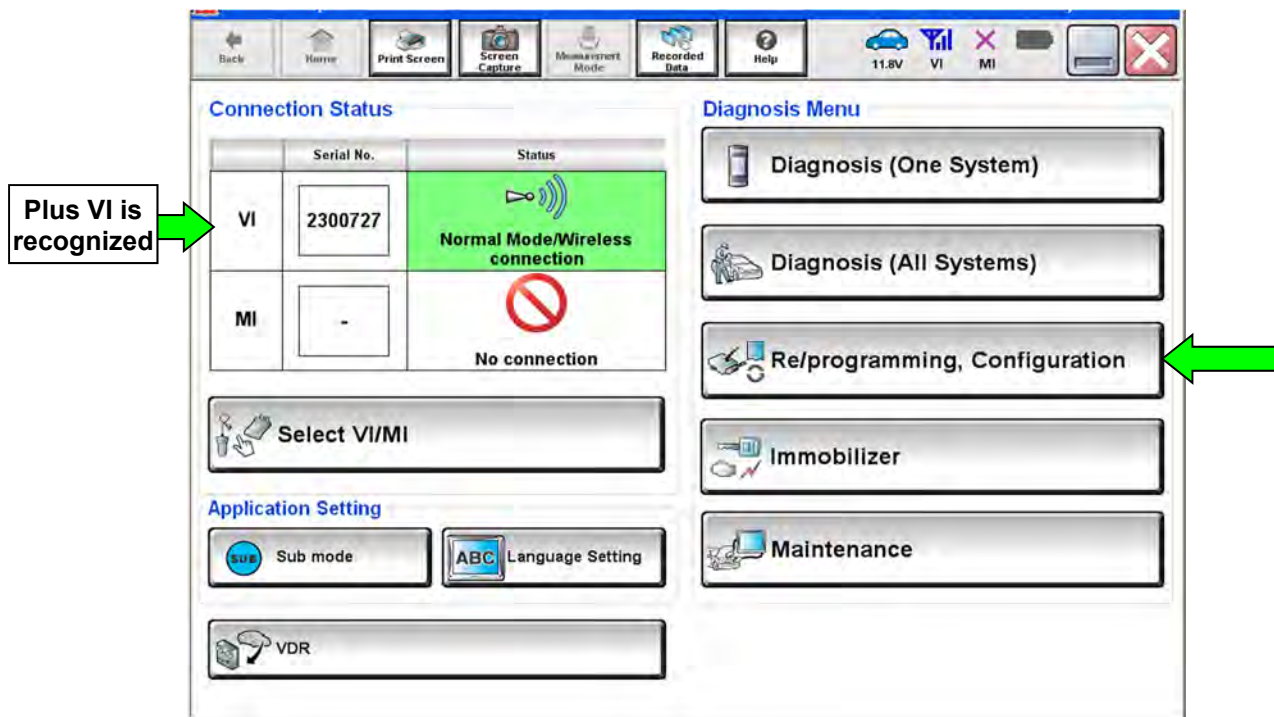

Figure 177

144. Follow the on-screen instructions and navigate the C-III plus to the screen shown in Figure 178 on the next page.

145. When you get to the screen shown in Figure 178, confirm reprogramming applies as follows.

A. Find the TCM **Part Number** and write it on the repair order.

HINT: This is the current TCM Part Number (P/N).

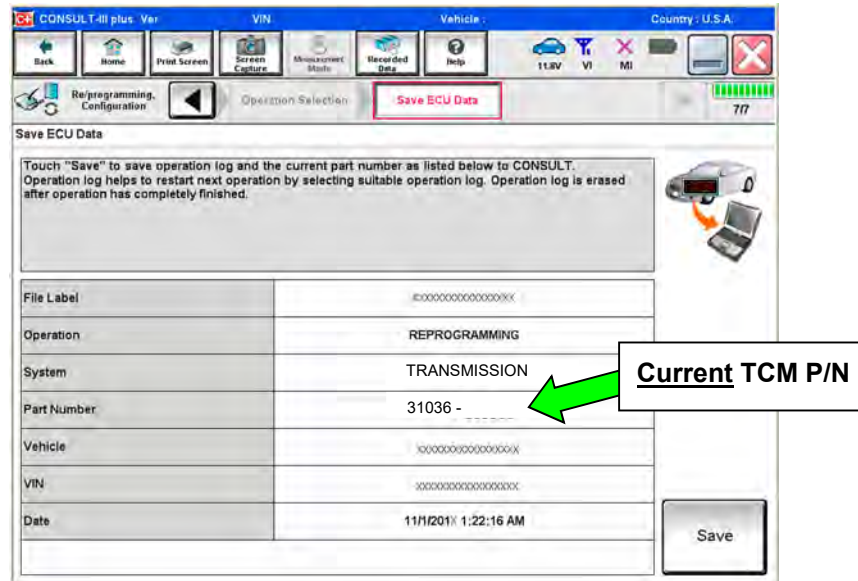

Figure 178

B. Compare the P/N you wrote down to the numbers in the **Current TCM Part Number** column in **Table B** below.

- If there is a match, continue with the reprogramming procedure; step 146.
- If there is not a match, reprogramming is not needed; skip to step 154 and perform **ADDITIONAL SERVICE WHEN REPLACING CONTROL VALVE**.

Table B

MODEL	MODEL YEAR	CURRENT TCM PART NUMBER BEFORE REPROGRAMMING: 31036 -
Altima	2018	3TD1A, 3TD2A 9HU1A, 9HU2A 9HU1B, 9HU2B
Rogue	2018	7FH0A, 7FH1A, 7FH5A, 7FH6A 7FH0B, 7FH1B 7FW0A, 7FW1A, 7FW5A, 7FW6A 7FW0B, 7FW1B

146. Follow the on-screen instructions to navigate C-III plus and reprogram the TCM.

NOTE:

- In some cases, more than one new P/N for reprogramming is available.
 - If more than one new P/N is available, the screen in Figure 179 displays.
 - Select and use the reprogramming option that does **not** have the message “Caution! Use ONLY with NTBXX-XXX”.
- If you get this screen and it is blank (no reprogramming listed), it means there is no reprogramming available for this vehicle.

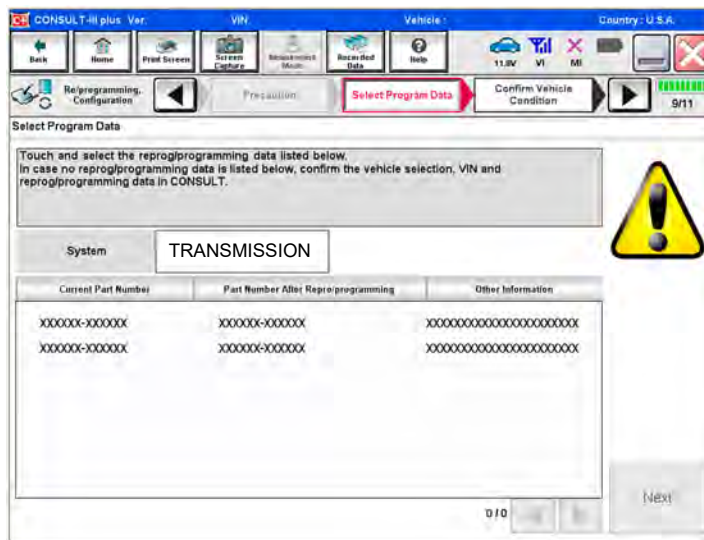

Figure 179

- Before reprogramming will start, you will be required to enter your User Name and Password.
 - The CONSULT PC must be connected to the Internet (Wi-Fi or cable).
 - If you do not know your User Name and Password, contact your Service Manager.

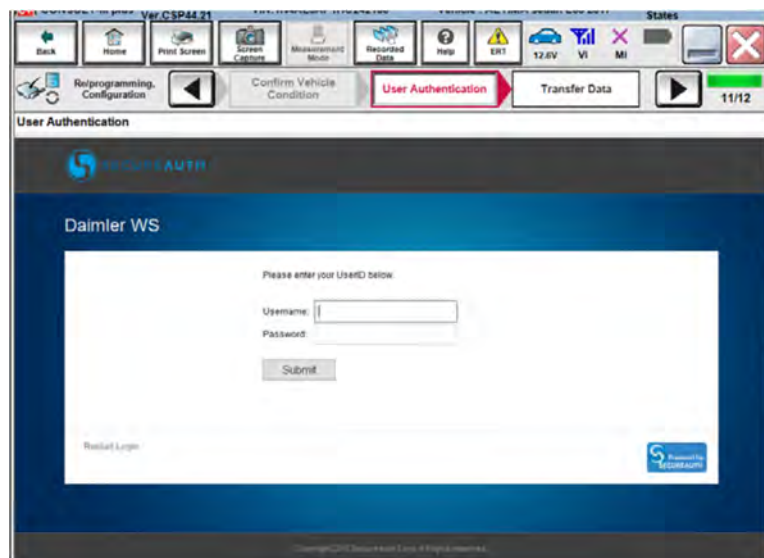

Figure 180

147. When the screen in Figure 181 displays, reprogramming is complete.

HINT: If the screen in Figure 181 does not display (indicating that reprogramming did not complete), refer to the information on the next page.

148. Disconnect the battery maintainer/smart charger from the vehicle.

149. Select **Next**.

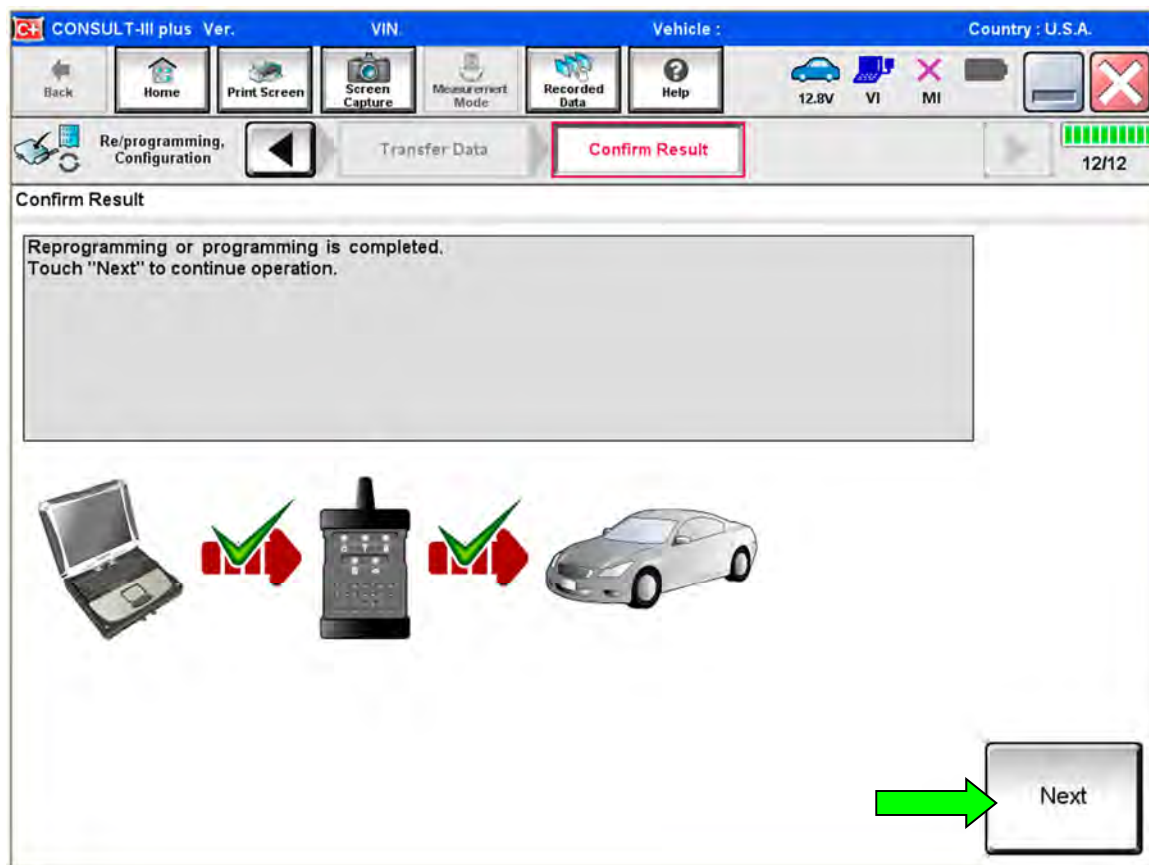

Figure 181

HINT:

- In the next step (page 89) you will perform **Erase All DTCs**.
- DTC erase is required before C-III plus will provide the final reprogramming confirmation report.

TCM Recovery:

Do not disconnect plus VI or shut down C-III plus if reprogramming does not complete.

If reprogramming does not complete and the “!?” icon displays as shown in Figure 182:

- Check battery voltage (12.0–15.5 V).
- Ignition is ON, engine OFF.
- External Bluetooth® devices are OFF.
- All electrical loads are OFF.
- **Select retry and follow the on screen instructions.**
- “Retry” may not go through on first attempt and can be selected more than once.

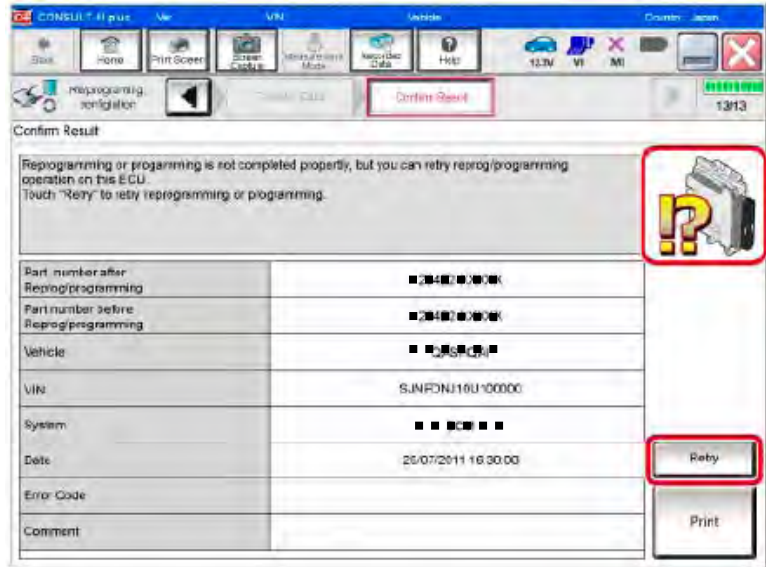

Figure 182

If reprogramming does not complete and the “X” icon displays as shown in Figure 183:

- Check battery voltage (12.0 – 15.5 V).
- CONSULT A/C adapter is plugged in.
- Ignition is ON, engine OFF.
- Transmission is in Park.
- All C-III plus / VI cables are securely connected.
- All C-III plus updates are installed.
- **Select Home, and restart the reprogram procedure from the beginning.**

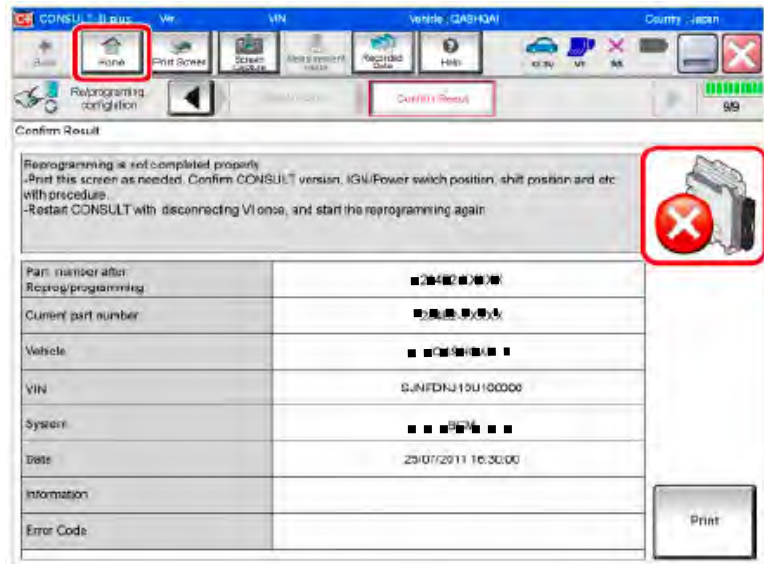

Figure 183

150. Follow the on-screen instructions to **Erase All DTCs**.

- When the entire reprogramming process is complete, the screen in Figure 184 will display.

151. Verify the before and after part numbers are different.

152. Print a copy of this screen (Figure 184) and attach it to the repair order for warranty documentation.

153. Select **Confirm**.

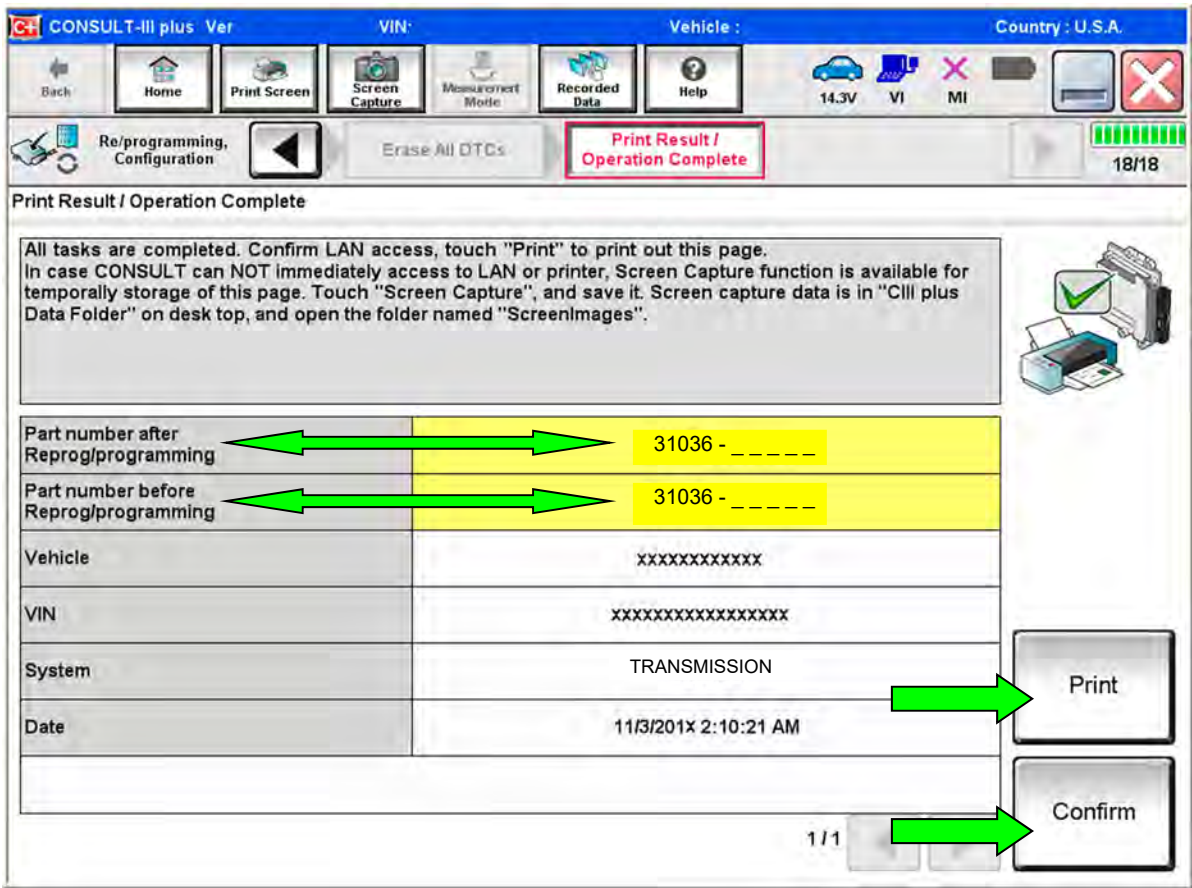

Figure 184

ADDITIONAL SERVICE WHEN REPLACING CONTROL VALVE

HINT: Steps 154-197 are additional services that must be performed after replacing the control valve.

Print Current Calibration Data

154. Select 'CALIB DATA" in "TRANSMISSION."

155. Print page 1 of 7 and attach it to the repair order.

Check the Serial Number

156. Write down the serial number (calibration file number) of the new control valve.

157. Compare the serial number (calibration file number) on the CD, QR code label and new control valve. All numbers must match.

158. Insert the supplied CD into CONSULT.

159. Select "Work Support" in "TRANSMISSION".

160. Select "WRITE IP CHARA - REPLACEMENT AT/CVT".

161. Select "OK" on the "Select IP characteristics data file" window.

162. Open the calibration file located on the supplied CD.

163. Confirm that the serial number (calibration file number) displayed on the CONSULT screen matches the serial number (calibration file number) on the new control valve.

164. Select "Next" on the "WRITE IP CHARA - REPLACEMENT AT/CVT" Work Support screen.

Write the Data (Write IP Chara)

165. With the ignition on and the engine off, press the brake pedal.

166. Shift the selector lever to the R position.

167. Depress the throttle pedal half way and hold, then press "START" on the CONSULT screen.

168. Write data to the TCM according to the instructions on the CONSULT screen.

HINT: When the calibration data has been written to the TCM, the current status will indicate "Complete".

169. Select "End".

Print New Calibration Data

170. Select “CALIB DATA” in “TRANSMISSION”.

171. Print page 1 of 7 and attach it to the repair order.

172. Return C-III plus to the Home screen.

FWD Clutch Point Learning

173. Apply the vehicle’s parking brake.

174. Start the engine and warm up to operating temperature (50-100° C [122-212° F]).

175. Select **Diagnosis (One System)**.

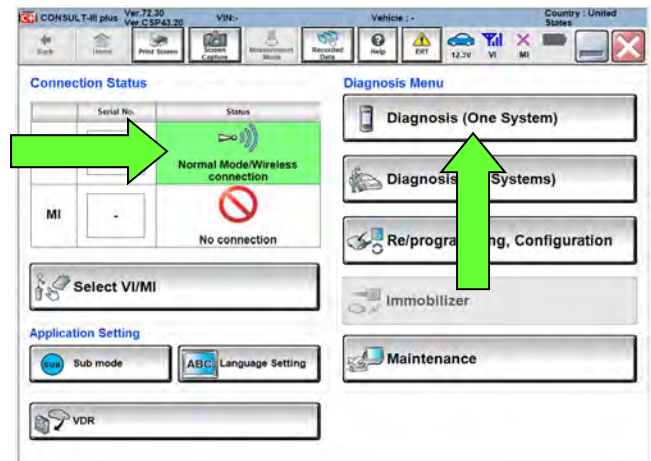

Figure 185

176. Select **Work Support** under TRANSMISSION.

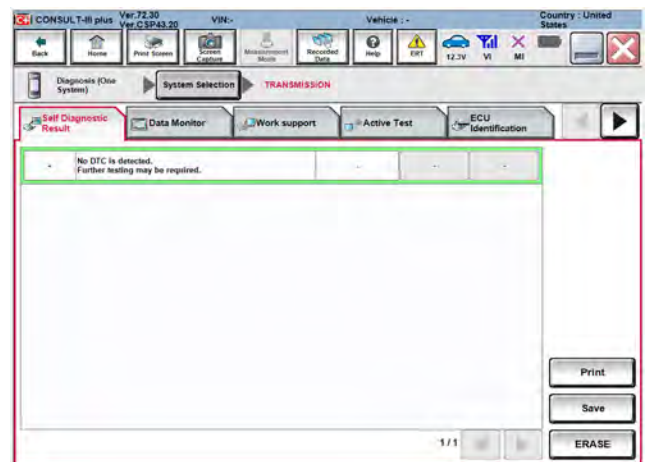

Figure 186

HINT: The following **FWD CLUTCH POINT LEARNING** will be performed twice; once in Drive (**D**) and once in Reverse (**R**).

177. Select **FWD CLUTCH POINT LEARNING** and then **Start**.

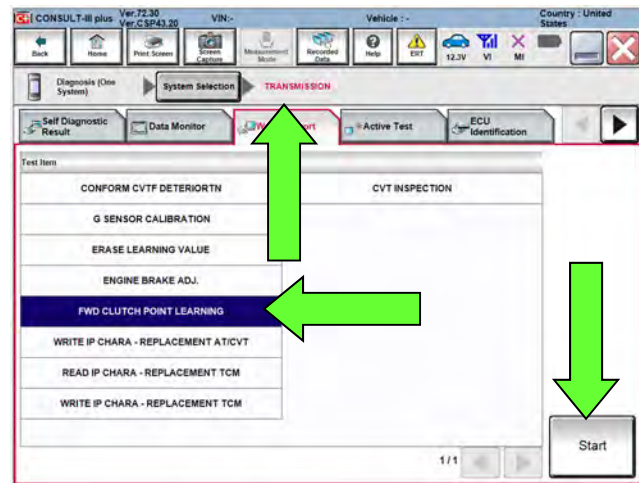

Figure 187

178. With the engine still running and at idle, depress the brake pedal and shift the CVT into neutral (**N**).

- Confirm that all of the required conditions indicated in Figure 188 are being met.

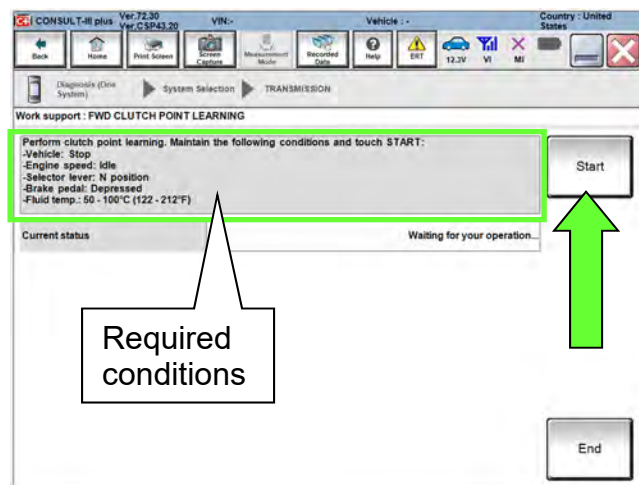

Figure 188

179. Select **Start**.

180. While maintaining all conditions shown in Figure 188 and the “Current status” indicates “EXECUTING”, shift the CVT into **D** and then wait until the Current status indicates “COMPLETED”.

HINT: This may take up to three (3) minutes to complete.

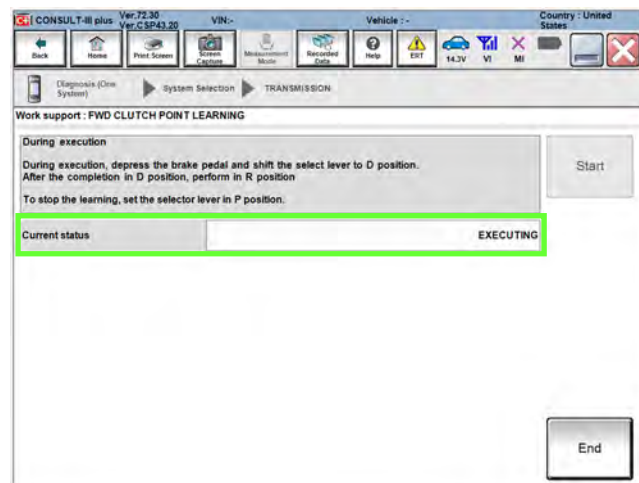

Figure 189

181. When the screen in Figure 190 is displayed, shift the CVT into **P**, and then select **End**.

182. Turn the engine OFF and then back ON.

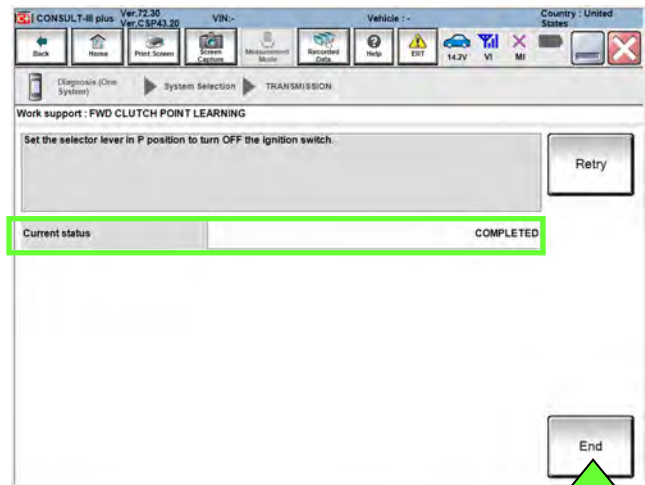

Figure 190

183. Select **FWD CLUTCH POINT LEARNING** and then **Start**.

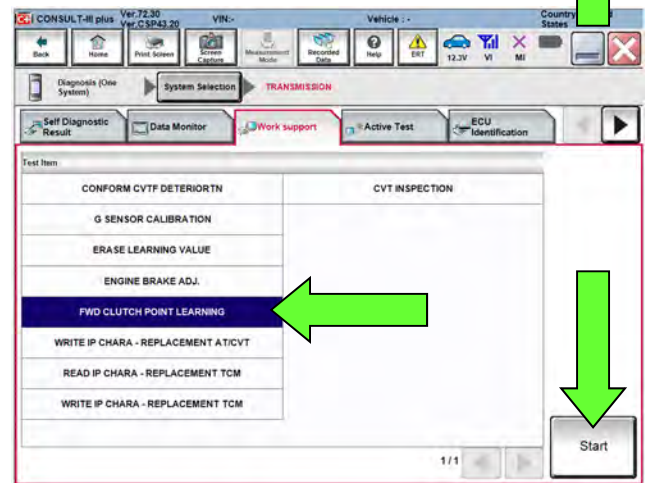

Figure 191

184. With the engine still running and at idle, depress the brake pedal and shift the CVT into neutral (**N**).

- Confirm that all of the conditions indicated in Figure 192 are being met.

185. Select **Start**.

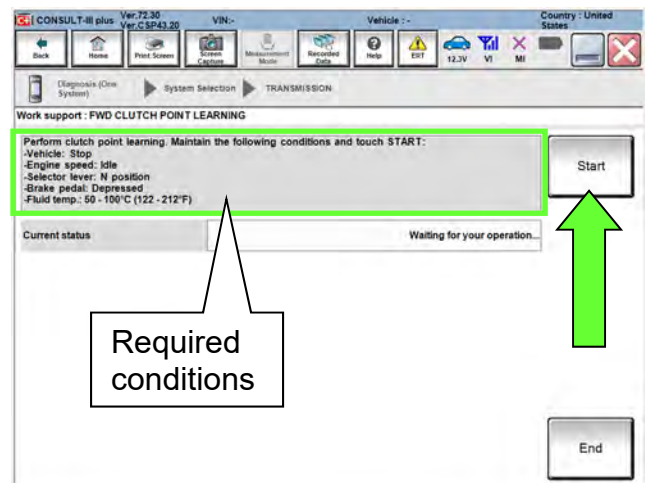

Figure 192

186. While maintaining all conditions shown in Figure 192 and the Current status indicates EXECUTING, shift the CVT into **R** and then wait until the Current status indicates COMPLETED.

HINT: This may take up to 3 minutes to complete.

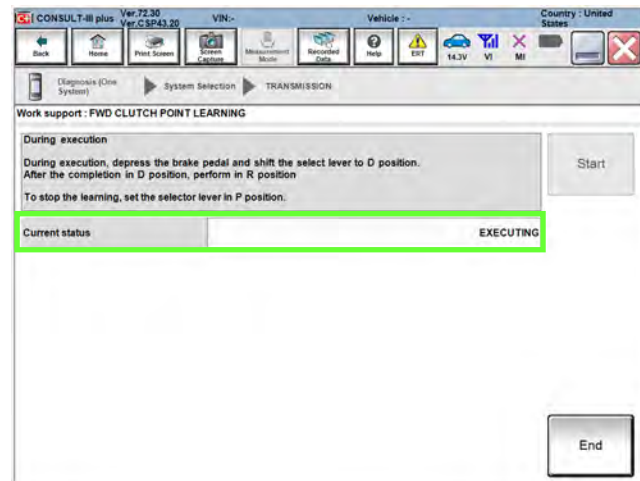

Figure 193

187. When the screen in Figure 194 is displayed select **End**, shift the CVT into **P**, and then turn the engine OFF.

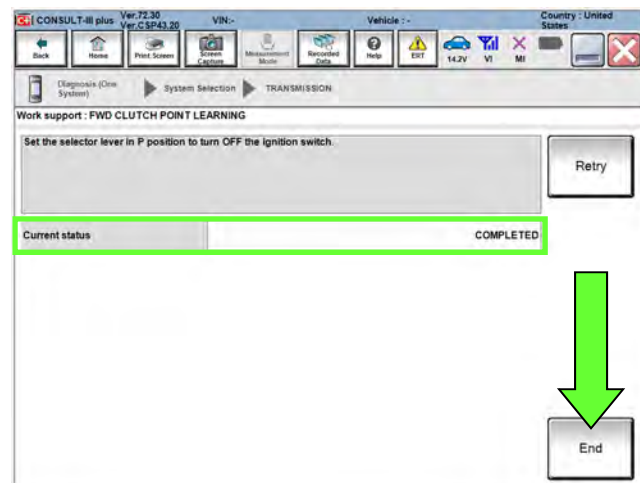

Figure 194

Perform Select Learning

188. Start the engine, and then wait five (5) seconds.
189. Move the shift selector to the **N** position and hold for more than two (2) seconds, and then move it to the **D** position and wait for transmission engagement.
190. Repeat step 189 ten times.
191. Move the shift selector to the **N** position and hold for more than 2 seconds, and then move it to the **R** position and wait for the transmission engagement.
192. Repeat step 191 ten times.
193. Move the shift selector to the **P** position, and then turn the ignition OFF.

Erase CVT Fluid Degradation Level Data

194. Select "Work Support" in "TRANSMISSION".
195. Select "CONFORM CVTF DETERIORATION".
196. Select "Clear".
197. Clear any DTCs that may have set and then test drive the vehicle.

PARTS INFORMATION

The following part kits are only to be used if the Sub-assembly is being replaced.

DESCRIPTION	PART #	QUANTITY
BELT-PULLEY KIT	2018 Altima	31214-28X9E
	2018 Rogue AWD	31214-28X9B
	2018 Rogue 2WD	31214-28X9C
CLAMP (Hose Spring Clamp)	16439-7S01E	2
VALVE ASSY KIT-CONTROL (Valve body)	3170E-28X0B	1
Valve Assy Kit-Control includes:		
VALVE ASSEMBLY-CONTROL (1)		1
STRAINER ASSY-OIL, AUTO TRANS		1
BRACKET (Temperature sensor bracket)		1
BAND (Zip tie for bracket)		1
GSKT-OIL PAN		1
SEAL-LIP (Between CVT and control valve)		1
Seal, O-Ring (fluid filler plug gasket)		1
SEAL-O RING (Transfer case to CVT AWD only)	33118-4BA0A	1
WASHER-DRAIN (For drain plug)	11026-JA00A	1
Loctite 5460 Sealant (2)	999MP-LT5460P	(3)
Nissan NS-3 CVT Fluid (4) (5)	999MP-CV0NS3	As needed
Transmission Cooler Cleaner (5)	999MP-AM006P	As needed
Lens Swab packet	J-51963	As needed

- (1) Includes QR label, CD-R, and control valve assembly.
- (2) Bill out Loctite 5460 Sealant under **expense code 008**. Do not include the Loctite 5460 Sealant part number on the claim.
- (3) One container of Loctite 5460 Sealant is good for approximately 5 repairs. This sealant is not included in any kit.
- (4) For warranty repairs, Nissan NS-3 CVT Fluid **must** be used. For customer pay repairs, Nissan NS-3 CVT Fluid, or an equivalent is recommended.
- (5) This item can be ordered through the Nissan Maintenance Advantage program: Phone: 877-NIS-NMA1 (877-647-6621) or Website: Order via link on dealer portal www.NNAnet.com and click on the "Maintenance Advantage" link.

If just a Control Valve is being replaced, use the following parts.

DESCRIPTION	PART #	QUANTITY
CLAMP (Hose Spring Clamp)	16439-7S01E	2
VALVE ASSY KIT-CONTROL (Valve body)	3170E-28X0B	1
Valve Assy Kit-Control includes:		
VALVE ASSEMBLY-CONTROL (1)		1
STRAINER ASSY-OIL, AUTO TRANS		1
BRACKET (Temperature sensor bracket)		1
BAND (Zip tie for bracket)		1
GSKT-OIL PAN		1
SEAL-LIP (Between CVT and control valve)		1
Seal, O-Ring (fluid filler plug gasket)		1
WASHER-DRAIN (For drain plug)	11026-JA00A	1
Nissan NS-3 CVT Fluid (2) (3)	999MP-CV0NS3	As needed
Transmission Cooler Cleaner (3)	999MP-AM006P	As needed
Lens Swab packet	J-51963	As needed

- (1) Includes QR label, CD-R, and control valve assembly.
- (2) For warranty repairs, Nissan NS-3 CVT Fluid must be used. For customer pay repairs, Nissan NS-3 CVT Fluid or an equivalent is recommended.
- (3) This item can be ordered through the Nissan Maintenance Advantage program:
Phone: 877-NIS-NMA1 (877-647-6621) or Website: Order via link on dealer portal www.NNAnet.com and click on the "Maintenance Advantage" link.

REMINDER! When instructed to reference the ESM for a repair procedure, ensure one-time-use parts are replaced.

CLAIMS INFORMATION

If Belt Inspection is not Performed and Sub-Assembly is replaced

Submit a Primary Part (PP) type line claim using the following claims coding:

OPERATION	PFP	OP CODE	SYM	DIAG	FRT
CVT R&R	(1)	JD01AA	ZE	32	(2)
		JD023A			
JX50AA		3.8			
JE99AA		(2)			
CVT SUBASSEMBLY (WITH CONTROL VALVE R&I) RP					
Reprogram TCM (when applicable)					

- (1) Reference the Parts Information Table and use the BELT-PULLEY KIT Part Number 31214-**** as the Primary Failed Part.
- (2) Reference the current Nissan Warranty Flat Rate Manual and use the indicated Flat Rate Time.

HINT: FRT allows adequate time to access DTC codes. No other diagnostic procedures subsequently required. Do NOT claim any diagnostic OP Codes with this claim.

EXPENSE CODE

EXPENSE CODE	DESCRIPTION	MAX AMOUNT
008	5460 Sealant	\$12.46

CLAIMS INFORMATION continued on the next page.

CLAIMS INFORMATION continued.

OR

If Belt Inspection is Performed and Sub-Assembly is replaced (belt inspection shows signs of belt slip, NG)

Submit a Primary Part (PP) type line claim using the following claims coding:

MODEL	OPERATION	PFP	OP CODE	SYM	DIAG	FRT
All	CVT R&R	(1)	JD01AA	ZE	32	(2)
			JD023A			
All	Inspect CVT Chain, Chain = NG (Includes control valve R&I)		JX36AA			1.1
Altima	Replace CVT Sub-assembly		JX45AA			2.9
Rogue						3.0
All	Reprogram TCM (when applicable)		JE99AA			(2)

- (1) Reference the Parts Information Table and use the applicable BELT-PULLEY KIT Part Number 31214-***** as the Primary Failed Part.
- (2) Reference the current Nissan Warranty Flat Rate Manual and use the indicated Flat Rate Time.

NOTE: FRT allows adequate time to access DTC codes. No other diagnostic procedures subsequently required. Do NOT claim any diagnostic OP Codes with this claim.

EXPENSE CODE

EXPENSE CODE	DESCRIPTION	MAX AMOUNT
008	5460 Sealant	\$12.46

OR

If Only Control Valve is replaced:

Submit a Primary Part (PP) type line claim using the following claims coding:

OPERATION	PFP	OP CODE	SYM	DIAG	FRT
Inspect CVT Chain, Chain = OK	(1)	JX37AA	ZE	32	0.3
Replace Control Valve		JD48AA			(2)
Reprogram TCM (When Applicable)		JE99AA			(2)

- (1) Reference the Parts Information Table and use the VALVE ASSY KIT-CONTROL part number (31705-*****) as the Primary Failed Part.
- (2) Reference the current Nissan Warranty Flat Rate Manual and use the indicated Flat Rate Time.

HINT: FRT allows adequate time to access DTC codes. No other diagnostic procedures subsequently required. Do NOT claim any diagnostic OP Codes with this claim.

Check off the parts as they are used in the Service Procedure and attach the completed form to the repair order.

PARTS KITS REFERENCE TABLE (Parts are listed in order of installation)

CHECK OFF	DESCRIPTION	PART #	QUANTITY	
	PUMP ASSY-OIL Kit 31340-28X8A includes:	PUMP ASSY-OIL	31340-28X0A	1
		SEAL-O RING	31526-28X0C	1 (of 7)
		RING-SNAP	31506-1XF12	1
	SEAL-O RING (O-ring between CVT case and side cover)	31526-28X0A	1	
	PULLEY ASSY - CVT (Belt and pulley "sub-assembly")	31214-28X7A	1	
	Loctite 5460 Sealant	999MP-LT5460P	As needed	
	BOLT	31377-1XD00 (or 31377-1XZ0B)	19 (of 42)	
	SEAL-O RING (For pulley retainer bolts)	31526-28X0C	6 (of 7)	
	SEAL-OIL,DIFF (Differential side oil seal; CVT case side)	38342-3VX0A	1	
	BRG ASSY-THRUST NEEDLE (Thrust bearing)	See page 100	1	
	SEAL ASSY-OIL (Torque converter oil seal; converter housing)	31375-1XF00	1	
	SEAL-OIL,DIFF (Differential side oil seal; converter housing side, front wheel drive only)	38342-3VX0B	1	
	SEAL-O RING (For input shaft)	31526-80X01	1	
	Loctite 5460 Sealant	999MP-LT5460P	As needed	
	BOLT	31377-1XD00	23 (of 42)	
	FLTR ASSY-OIL,AUTO TRANS (CVT fluid filter)	31726-28X0A	1	
	SEAL-O RING (For filter cover)	31526-3VX0A	1	
	SEAL-LIP (Between CVT and control valve)	31528-1XZ0A	1	
	BRACKET (Temperature sensor bracket)	31069-3VX0D	1	
	VALVE ASSY-CONT (Control valve)	31705-28X0B	1	
	BAND (Zip tie for bracket)	24224-3VX0A	1	
	STRAINER ASSY-OIL, AUTO TRANS	31728-28X0A	1	
	GSKT-OIL PAN	31397-1XF0D	1	
	WASHER-DRAIN (For drain plug)	11026-JA00A	1	
	Seal O-Ring (Speed Sensor)	31526-1XG0C	1	
	Transmission Cooler Cleaner	999MP-AM006P	As needed	
	CLAMP (Hose Spring Clamp)	16439-7S01E	2	
	SEAL-O RING (CVT filler plug at converter housing)	31526-3VX0B	1	
	Nissan NS-3 CVT Fluid	999MP-CV0NS3	As needed	
	SEAL-O RING (Transfer case to CVT, AWD only)	33118-4BA0A	1	

THRUST BEARINGS

DESCRIPTION	PART #: 31407-	BEARING THICKNESS	QTY
THRUST BEARING	1XZ0B	3.57	1 of each is included in the Pulley Kit. Select 1 for installation.
	1XZ0C	3.75	
	1XZ0D	3.93	
	1XZ0E	4.1	
	1XZ1A	4.28	
	1XZ1B	4.46	
	1XZ1C	4.61	
	1XZ1D	4.79	

PART KITS VISUAL REFERENCE

- The following Figures show the smaller components of KIT-PULLEY.
- KIT- CONTROL VALVE is not shown.



Figure 195 shows the assorted seals, O-rings, etc. in "KIT-PULLEY"

Figure 195

PUMP ASSY-OIL parts



Figure 196

BRG ASSY-THRUST NEEDLE parts

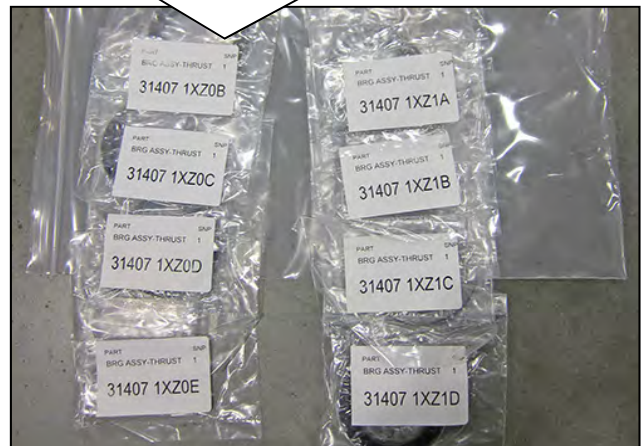

Figure 197

REMINDER! Attach the following to the repair order:

- Total EndPlay calculation (Page 63)
- Parts Kit Reference Table (Page 99)
- C-III plus screen showing the TCM part number before and after the reprogramming (Step 152 on page 89)
- C-III plus screen showing the current calibration data (Step 155 on page 90)
- C-III plus screen showing the new calibration data (Step 171 on page 91)

AMENDMENT HISTORY

DATE	REFERENCE	DESCRIPTION
October 8, 2019	NTB19-076	Original bulletin published

