

TECHNICAL INSTRUCTIONS
FOR
LIMITED SERVICE CAMPAIGN K0P
CUSTOMER SUPPORT PROGRAM 19TE12

SAFETY CONNECT SYSTEM – VEHICLE LOCATION INACCURATE

CERTAIN
2013 – 2019 MODEL YEAR 4RUNNER
2011 – 2017 MODEL YEAR LAND CRUISER
2013 – 2017 MODEL YEAR PRIUS
2012 – 2017 MODEL YEAR PRIUS V
2016 – 2017 MODEL YEAR MIRAI

Updated 10/17/2019

Update 10/17/19

- The title has been updated to include Customer Support Program 19TE12

Update 9/13/19

- The process has been updated to address an issue with Techstream. Technicians will no longer determine if an update is required based on the Update column Yes/No option displayed during a health check. Technicians will determine if an update is required based on calibration ID only

The repair quality of covered vehicles is extremely important to Toyota. All dealership technicians performing this LSC are required to successfully complete the most current version of the E-Learning course "Safety Recall and Service Campaign Essentials". To ensure that all vehicles have the repair performed correctly; technicians performing this LSC repair are required to currently hold at least one of the following certification levels:

- Certified Technician (any specialty)
- Expert Technician (any specialty)
- Master Technician
- Master Diagnostic Technician

It is the dealership's responsibility to select technicians with the above certification level or greater to perform this LSC repair. Carefully review your resources, the technician skill level, and ability before assigning technicians to this repair. It is important to consider technician days off and vacation schedules to ensure there are properly trained technicians available to perform this repair at all times.

I. OPERATION FLOW CHART

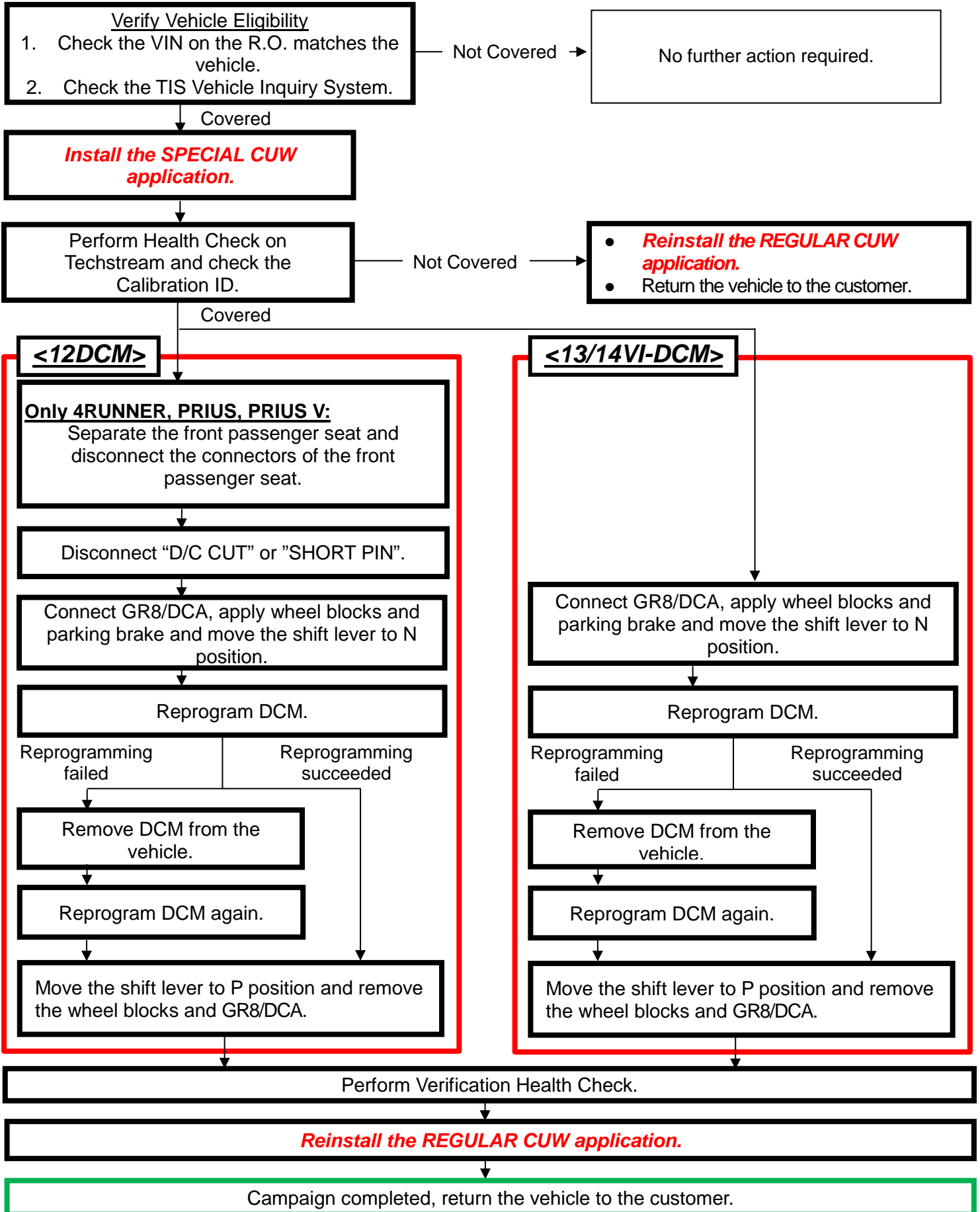

II. IDENTIFICATION OF AFFECTED VEHICLES

NOTE:

- Check the TIS Vehicle Inquiry System to confirm the VIN is involved in this LSC and that the campaign has not already been completed prior to dealer shipment or by another dealer.
- TMNA warranty will not reimburse dealers for repairs conducted on vehicles that are not affected or were completed by another dealer.

III. PREPARATION

A. TOOLS & EQUIPMENT

- Standard Hand Tools
- CUW Maintenance Tool
- Battery Diagnostic Station
- Techstream 2.0 / TIS Techstream / Techstream Lite (Software 14.1 or Higher)

B. CABLE No.1 & CABLE No.2

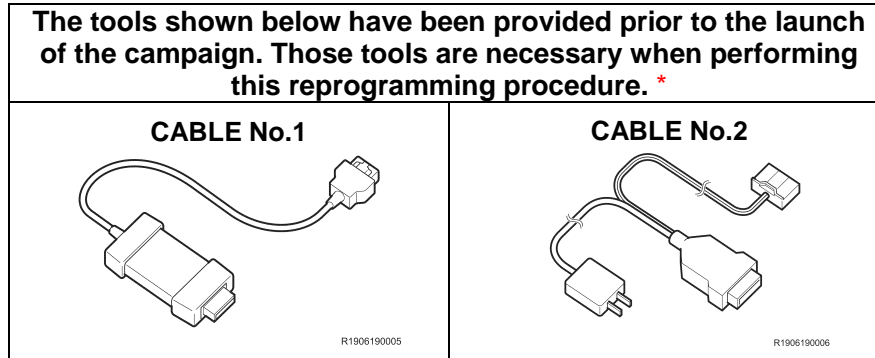

* **DO NOT** use these tools except for this campaign.

IV. BACKGROUND

The Data Communication Module (DCM) in the subject vehicles are equipped with software to identify the location of the vehicle using the Global Positioning System (GPS) to support features of the Safety Connect system. Due to incorrect programming in the DCM software, after November 2nd, 2019, the GPS coordinates for this system will be calculated incorrectly. This will cause the system to use incorrect vehicle coordinates if one of the system's features is activated.

V. PROCEDURE OVERVIEW



CRITICAL INFORMATION



- You will perform the reprogramming after installing a dedicated CUW application (Special CUW (only for DCM)) to a Techstream. By using this dedicated CUW application, the reprogramming time can be shortened.
- The reprogramming takes more than 60 minutes to complete, and the vehicle will turn the IG OFF automatically when it has passed about 60 minutes with IG ON while the shift lever is in P position.

Therefore, make sure to perform the following works before starting the reprogramming.

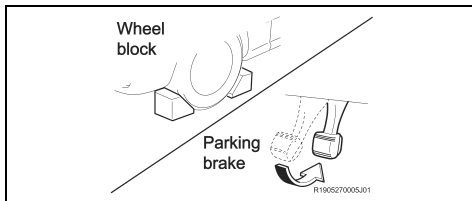

<<APPLY WHEEL BLOCKS AND PARKING BRAKE>>

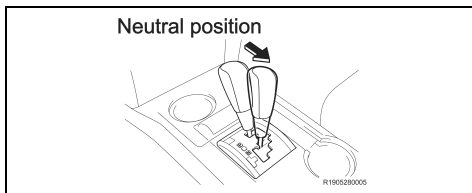

<<MOVE THE SHIFT LEVER TO N POSITION>>

VI. SAFETY PRECAUTIONS



CRITICAL INFORMATION - READ THOROUGHLY



An ECU could be damaged if an error occurs in the communication while reprogramming the ECU. Confirm all work is performed as described in these instructions.

Be sure to connect the personal computer to an external AC power supply.

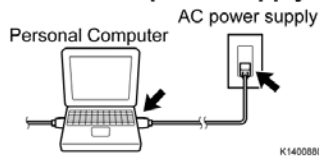

Turn off the screen saver and power saving mode.



DO NOT block the ventilation opening.



1. STABILIZE THE POWER TO THE TECHSTREAM SIDE

- a) Be sure to connect the Techstream to an external AC power supply.

NOTE:

The ECU could be damaged if the battery voltage of the Techstream drops while reprogramming.

- b) Turn off the screen saver and power saving mode of the Techstream so that the power to the hard disk is kept supplied.

NOTE:

If the screen saver or power saving mode launches while reprogramming, the communication may be disconnected, resulting in the damage of the ECU.

- c) **DO NOT** block the ventilation opening for the cooling fan of the Techstream.

NOTE:

If the ventilation opening for the cooling fan is blocked with a sheet cover or the like, the Techstream may be heated excessively, causing the operation of the Techstream to stop. Due to the stop of the operation, the communication for reprogramming signals could be stopped, resulting in the damage of the ECU.

VII. INSTALLATION OF THE SPECIAL CUW APPLICATION



- Please make sure to use the special CUW application when performing the ECU reprogramming.
- You cannot exit the special CUW application until you complete the reprogramming.

1. DOWNLOAD THE SPECIAL CUW APPLICATION

- a) Click the link below to download the Special CUW Application

[SPECIAL CUW APPLICATION](#)



2. RUN THE INSTALLER



3. SELECT THE SPECIAL CUW APPLICATION

- a) Select "Special CUW (only for DCM)".
- b) Click on the "Next" button to install the special CUW application.



4. COMPLETE INSTALLATION

- a) Click on the "Finish" button to finish.
NOTE: Use the special CUW application after installing it to the personal computer which has Techstream.

VIII. VEHICLE PREPERATION

1. VEHICLE PREPERATION

- a) Record settings of the audio system, air conditioner, front seats position, etc. since the cable of the negative battery terminal is going to be disconnected in a later step.



Confirm the following conditions

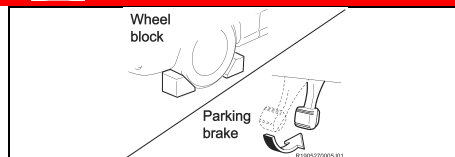

- Vehicle in the IG ON position (engine off).
- Turn off all electrical accessories (i.e. audio system, etc.)
- Windshield wiper switch in the OFF position.
- Headlight switch in the DRL OFF position.

2. CONNECT THE 12V BATTERY TO A POWER SUPPLY (GR8/DCA)

- a) Connect the GR8/DCA or other type of a power supply (not a battery charger) to the 12V battery.
- b) Select the Power Supply Mode from the Charge Menu of the GR8/DCA.



A power supply MUST be used during reprogramming. ECU damage will occur if the battery voltage is not properly maintained during this re-flash procedure.

NOTE: A power supply must be connected directly to the 12V battery terminals and NOT the remote jump posts under the hood (if equipped).

IX. CHECK FOR DTC'S

1. CONNECT THE TECHSTREAM TO THE VEHICLE

- a) Turn the IG OFF.
- b) Using a Cable No.1 (provided tool), connect the Techstream to the vehicle.

NOTE: DO NOT use this tool except for this campaign.



Follow the instructions below. Otherwise, the battery voltage will decrease or communication will become disabled, and this may require the replacement of the DCM.

- Turn off the screen saver and power saving mode of the PC.
- Use the external power supply for the PC. (**DO NOT** use the PC's internal battery or vehicle's battery.)
- Ensure that the communication cable connectors are securely connected, the cable is in good condition, and the connection is stable.

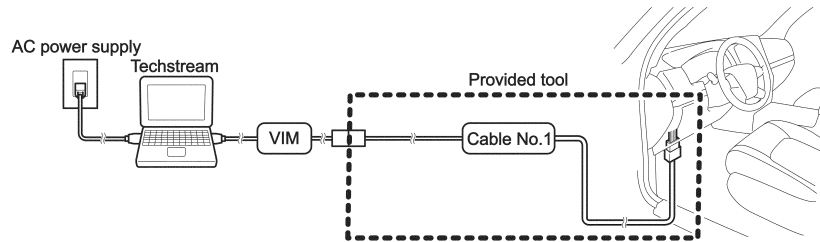

2. VERIFY TECHSTREAM SETUP

- a) Verify that the Techstream meets the following conditions:
 - The software version 14.1 or higher is loaded.
 - The Techstream battery is fully charged. If not, connect the Techstream to a 120V source.
 - The DLCIII cable is in good condition.



The Techstream's battery voltage must also be maintained during the re-flash procedure. If necessary, plug the Techstream into a 120v outlet during this procedure.

NOTE: If the Techstream communication with the vehicle fails during the re-flash procedure, the DCM will be damaged.



3. CHECK FOR DTCs

- a) Using a Techstream, perform a Health Check to check for any Diagnostic Trouble Codes.

NOTE: This Campaign covers only the software update to the Telematics System, as detailed in these instructions. It does not cover the diagnosis or replacement of any other systems on the vehicle.

X. TELEMATICS SYSTEM CALIBRATION ID CHECK



Action to take for Telematics System Reprogramming



There are 3 different ways to reprogram the Telematics System
Make sure to follow the instructions of these technical instructions.

1. CHECK CURRENT CALIBRATION

a) Determine the status of an available update; indicated by the calibration ID.

Note: Do not use the update column and an indicator if an update is required as it will always say No. Only use calibration ID

Yes

Is the calibration ID listed in the table below?

No

Proceed to the next step.

- Campaign complete. Return the vehicle to the customer.
- **Reinstall the REGULAR CUW** application.

b) Reprogram the Telematics System to the **NEW** CID following the table below.

NOTE: Take note of both current and new CID to be able to select correctly.

DCM(Telematics System) Calibrations		
DCM Model	Current CID	Action
12DCM	00002. 40 .06.04.01.91	Go to section XI
13/14 VI-DCM	00003. 00 .05.01.03.16	Go to section XII
	00003. 00 .05.01.03.21	
	00003. 00 .05.01.13.02	
	00003. 00 .05.01.13.03	
	00003. 00 .05.01.13.04	
	00003. 00 .05.01.13.06	
CID other than above		Go to section XVI

XI. 12DCM UPDATE CALIBRATION



Vehicle preparation before updating the telematics system



1. VEHICLE PREPARATION BEFORE UPDATING THE TELEMATICS SYSTEM

a) Turn the IG to the OFF position.

Be sure to disconnect each connector after disconnect the negative battery terminal

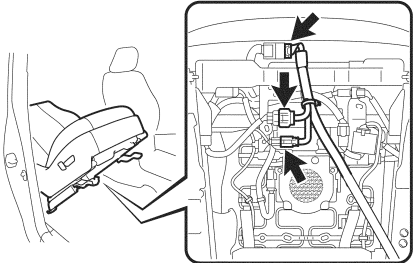

R1906190002

This illustration uses 4RUNNER for reference

b) DISCONNECT THE FRONT PASSENGER SEAT CONNECTORS **(Only 4RUNNER, PRIUS, PRIUS V)**

NOTE:

- The reprogramming may fail if you perform it without disconnecting the connectors. Please make sure to disconnect the connectors before performing the reprogramming.
- Disconnect the cable from the negative battery terminal to disable the SRS system. Refer to the repair manual in detail.
- Be sure to disconnect each connector after disconnect the negative battery terminal.

(1) Separate the front passenger seat, and then disconnect each connector of the front passenger seat.

NOTE:

- Separate the front passenger seat following the instructions on the repair manual. However, there is no need to take it out.
- Depending on seat type, you may need to perform certain initializations (such as Zero Point Calibration) refer to the repair manual for details

Go on TIS and refer to the repair manual for how to separate the seat

Path: SEAT / FRONT SEAT ASSEMBLY / REMOVAL

Note: you can copy and paste the path above into the TIS search bar to access the instructions quickly

(2) Connect the negative battery terminal and GR8/DCA.

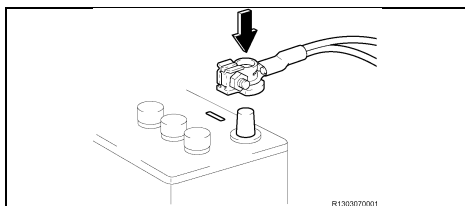

R1303020001

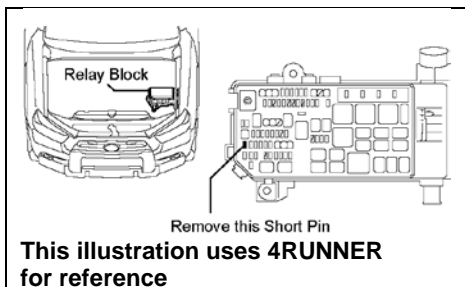

Remove this Short Pin

This illustration uses 4RUNNER for reference

c) DISCONNECT "D/C CUT" OR "SHORT PIN"

NOTE:

- The reprogramming may fail if you perform it without disconnecting the "D/C CUT" or "SHORT PIN". Please make sure to disconnect the "D/C CUT" or "SHORT PIN" before performing the reprogramming.
- Refer to Section XIV for the location of "D/C CUT" and "SHORT PIN" of each vehicle model.

d) Turn the IG to the ON position (engine off).

NOTE:

DO NOT start the engine.

HINT:

Depending on the model, method of IG ON may be different.

Hold the key directly in front of the button

Press the button twice with the brake released

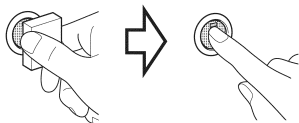

R1906200002

2. UPDATE THE TELEMATICS SYSTEM

Click the **NEW CID** link below to update the DCM

DCM(Telematics System) Calibrations

DCM Model	Current CID	NEW CID
12DCM	00002. 40 .06.04.01.91	00002.80.06.04.01.91



Check the CUW application



a) Check if the Special CUW (only for DCM) is downloaded.

NOTE:

If Special CUW (only for DCM) has not been downloaded, follow the instructions of section VII.

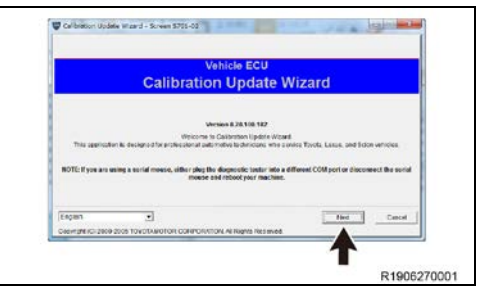

b) When Calibration Update Wizard is launched, click on "Next".

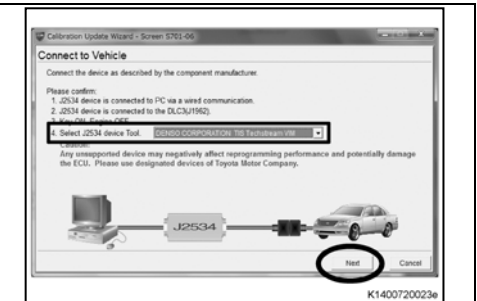

c) Select a device tool, and then click on "Next".

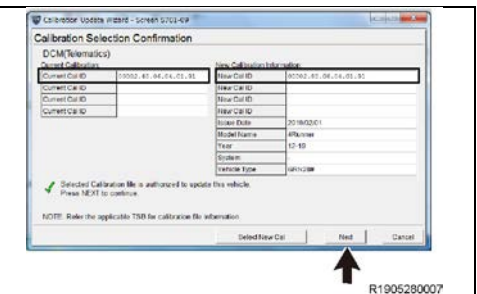

d) Confirm that "Current Cal ID" and "New Cal ID" are correct, and then click on "Next".

NOTE: The calibration IDs will be displayed as shown on the left. Please make sure you *DO NOT* mistake where to check to confirm the IDs.

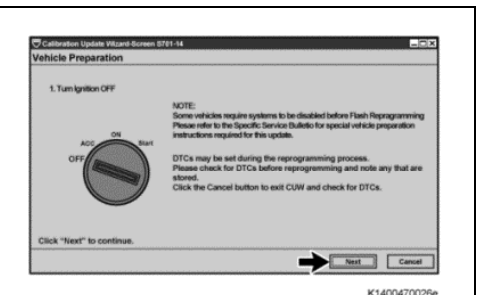

e) Follow the on-screen instructions and turn the IG off, and then click on "Next".

NOTE: After "Next" is clicked, a bar showing the progress is displayed. *DO NOT* turn the IG on while the bar is shown.



Vehicle condition before reprogramming DO NOT start the engine.



Hold the key directly
in front of the button

Press the button twice
with the brake
released

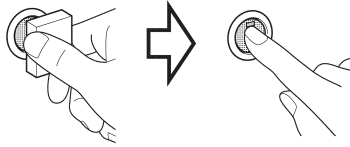

R190620002



Neutral position

P → R → N

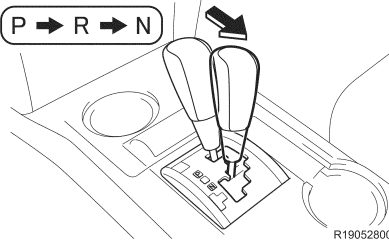

R1905280005

- f) Turn the IG to the ON position (engine off).

NOTE:

DO NOT depress the brake pedal.

HINT:

Depending on the model, method of IG ON may be different.

- g) Move the shift lever to Neutral position.

NOTE:

- The reprogramming takes more than 60 minutes to complete, and the vehicle will turn the IG OFF automatically when it has passed about 60 minutes with IG ON while the shift lever is in P position. Therefore, make sure to move the shift lever to N position before starting the reprogramming.
- The alarm sound will be heard if the door is fully closed with IG ON while the shift lever is in Neutral position, on either of the following conditions:
 - The key is outside the vehicle
 - The key battery is low

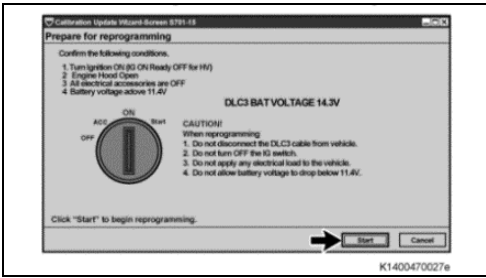

h) Click on "Start".

i) While reprogramming, the screen shown on the below is displayed.

NOTE:

- As reprogramming completes within approximately 75 minutes, stay near the vehicle and **DO NOT** allow any third parties to operate the vehicle or Techstream in order to prevent troubles from being occurred. The following phenomena may be observed while reprogramming due to interrupted communication. However, there is no problem.
 - Vehicle proximity alarming sound.
 - Blackout navigation screen (black).
 - Indication of a warning lamp or error message in the meter.
- "Now processing" is displayed for about 10 minutes. **DO NOT** finish reprogramming until the screen changes.

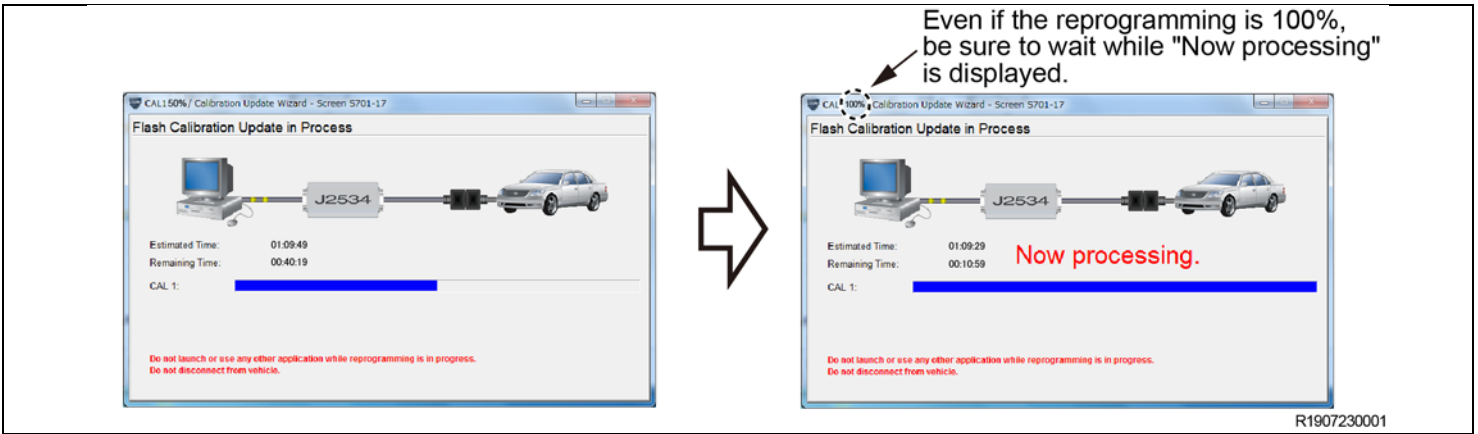

STOP If the following window is displayed and the reprogramming has failed, click on "Retry" and then "Cancel" to finish the reprogramming process. Remove the DCM (telematics transceiver) from the vehicle and perform the reprogramming procedure again only to the DCM (telematics transceiver). Refer to Section XIII

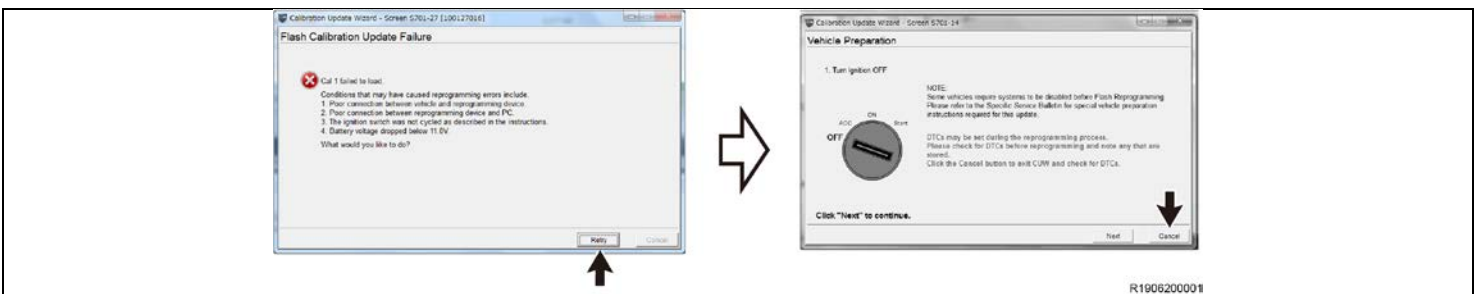

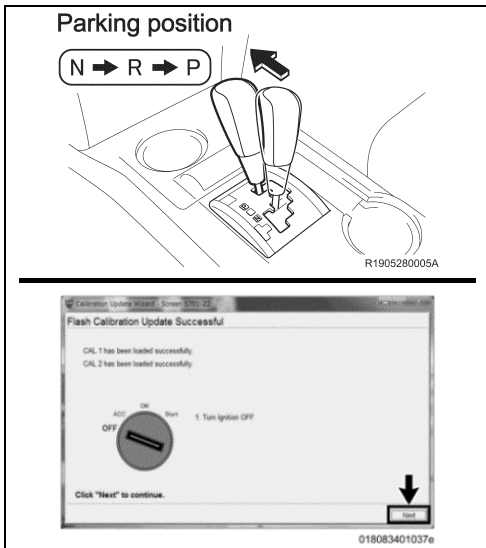

- j) After “Flash Calibration Update Successful” is displayed, move the shift lever to Parking position and turn the IG off and click the “Next” button.

NOTE: After “Next” is clicked, a bar showing the progress is displayed. **DO NOT** turn the IG on while the bar is shown.

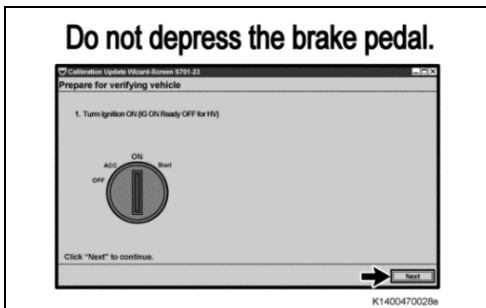

- k) Follow the on-screen instructions and turn the IG on, and then click the “Next” button.

NOTE: **DO NOT** turn the IG on with the brake pedal depressed. Otherwise the engine starts.

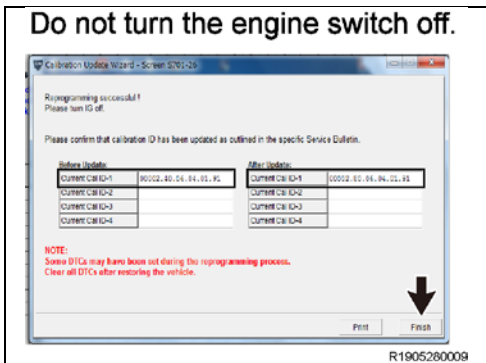

- l) After reprogramming, make sure that the "After update "Current Cal ID" is correct.

- m) Click the “Finish” button.

STOP Click the “Finish” button with the IG on, even though the instruction on the screen says to turn the IG off.

After the reprogramming has been completed, refer to Section XV and restore the vehicle.

XII. 13/14VI-DCM UPDATE CALIBRATION

1. UPDATE THE TELEMATICS SYSTEM

Click the **NEW CID** link below to update the DCM

DCM(Telematics System) Calibrations		
DCM Model	Current CID	NEW CID
13/14 VI-DCM	00003.00.05.01.03.16	00003.20.05.01.03.16
	00003.00.05.01.03.21	00003.20.05.01.03.21
	00003.00.05.01.13.02	00003.20.05.01.13.02
	00003.00.05.01.13.03	00003.20.05.01.13.03
	00003.00.05.01.13.04	00003.20.05.01.13.04
	00003.00.05.01.13.06	00003.20.05.01.13.06

STOP

Check the CUW application

STOP



a) Check if the Special CUW (only for DCM) is downloaded.

NOTE:

If Special CUW (only for DCM) has not been downloaded, follow the instructions of section VII.

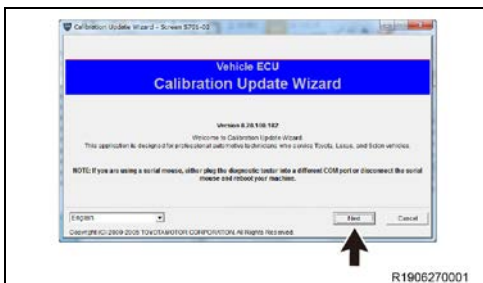

b) When Calibration Update Wizard is launched, click on "Next".

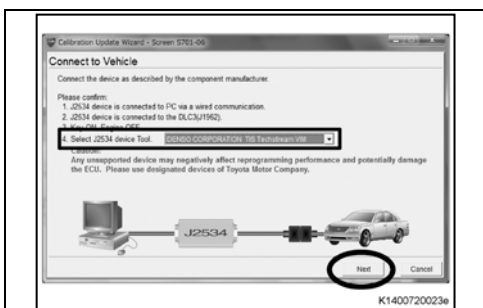

c) Select a device tool, and then click on "Next".

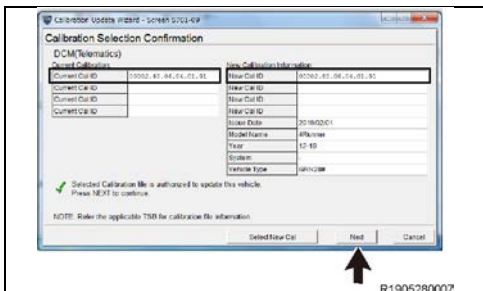

d) Confirm that "Current Cal ID" and "New Cal ID" are correct, and then click on "Next".

NOTE: The calibration IDs will be displayed as shown on the left. Please make sure you **DO NOT** mistake where to check to confirm the IDs.

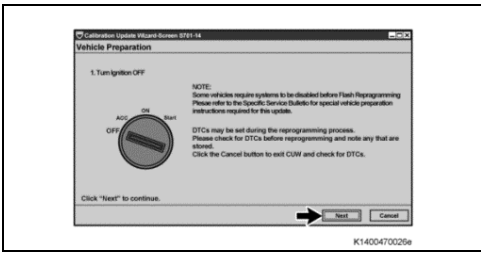

e) Follow the on-screen instructions and turn the IG off, and then click on “Next”.

NOTE: After “Next” is clicked, a bar showing the progress is displayed. **DO NOT** turn the IG on while the bar is shown.



Vehicle condition before reprogramming **DO NOT** start the engine.

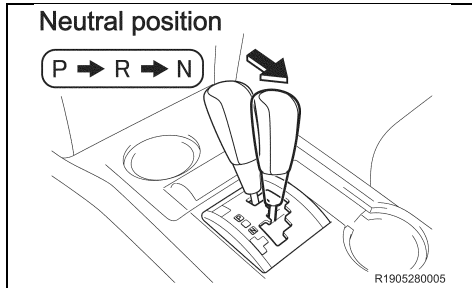

f) Turn the IG to the ON position (engine off).

NOTE:
DO NOT depress the brake pedal.

g) Move the shift lever to Neutral position.

NOTE:

- The reprogramming takes more than 60 minutes to complete, and the vehicle will turn the IG OFF automatically when it has passed about 60 minutes with IG ON while the shift lever is in P position. Therefore, make sure to move the shift lever to N position before starting the reprogramming.
- The alarm sound will be heard if the door is fully closed with IG ON while the shift lever is in Neutral position, on either of the following conditions:
 - The key is outside the vehicle
 - The key battery is low

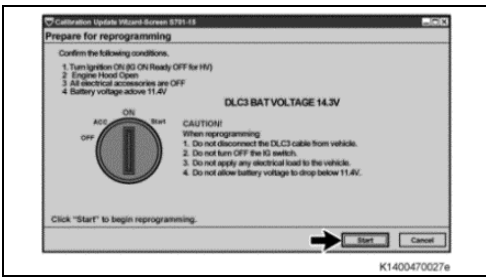

h) Click on "Start".

i) While reprogramming, the screen shown on the below is displayed.

NOTE:

- As reprogramming completes within approximately 85 minutes, stay near the vehicle and **DO NOT** allow any third parties to operate the vehicle or Techstream in order to prevent issues from occurring. The following phenomena may be observed while reprogramming due to interrupted communication. However, there is no problem.
 - Vehicle proximity alarming sound.
 - Blackout navigation screen (black).
 - Indication of a warning lamp or error message in the meter.
- "Now processing" is displayed for about 10 minutes. **DO NOT** finish reprogramming until the screen changes.

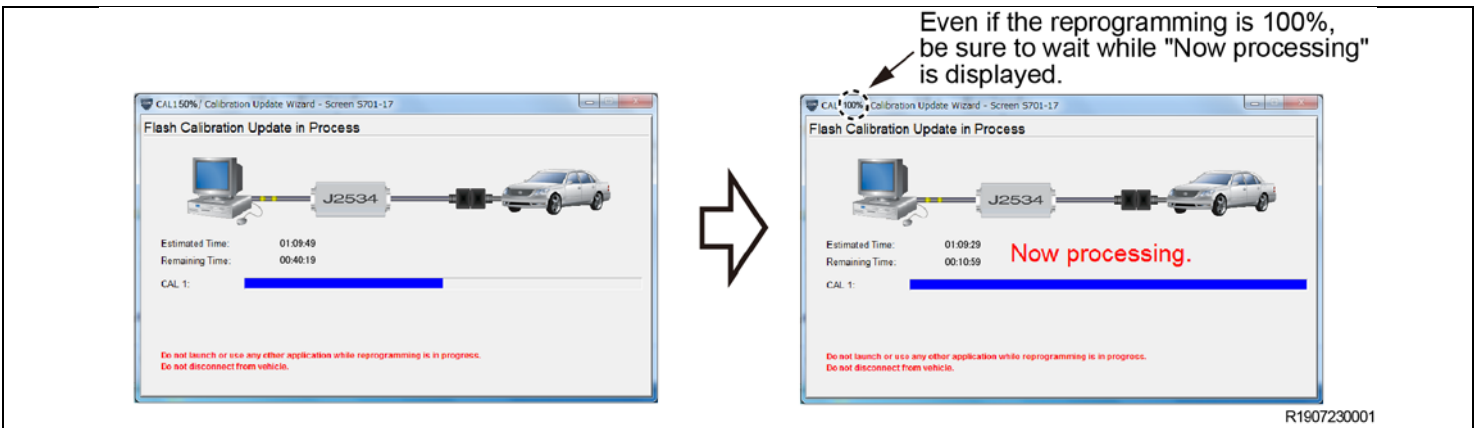

STOP If the following window is displayed and the reprogramming has failed, click on "Retry" and then "Cancel" to finish the reprogramming process. Remove the DCM (telematics transceiver) from the vehicle and perform the reprogramming procedure again only to the DCM (telematics transceiver). Refer to Section XIII

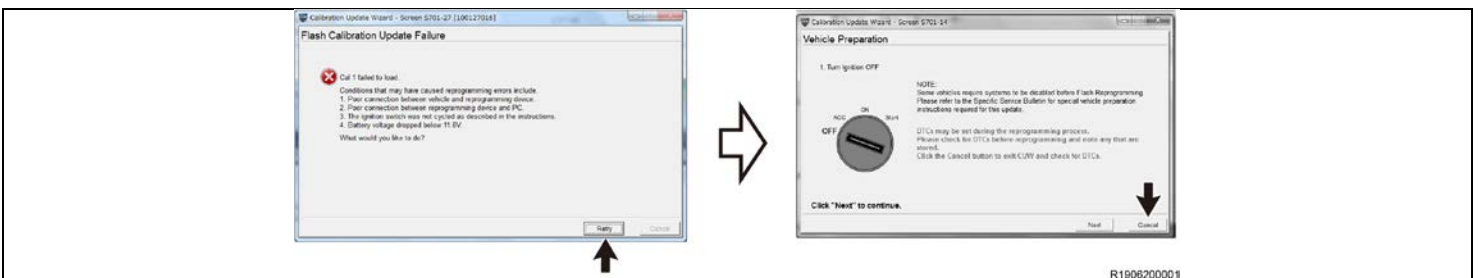

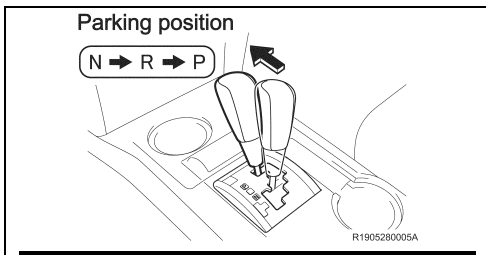

- j) After “Flash Calibration Update Successful” is displayed, move the shift lever to Parking position and turn the IG off and click the “Next” button.

NOTE: After “Next” is clicked, a bar showing the progress is displayed. **DO NOT** turn the IG on while the bar is shown.

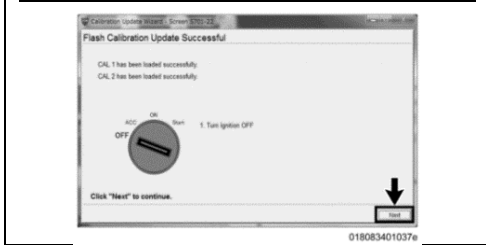

- k) Follow the on-screen instructions and turn the IG on, and then click the “Next” button.

NOTE: **DO NOT** turn the IG on with the brake pedal depressed. Otherwise the engine starts.

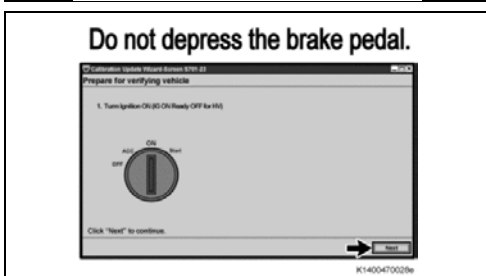

- l) After reprogramming, make sure that the "After update "Current Cal ID" is correct.

- m) Click the “Finish” button.

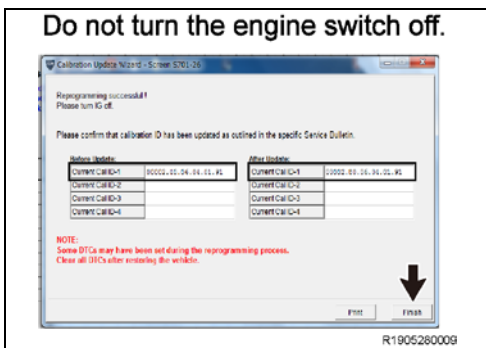

STOP Click the “Finish” button with the IG on, even though the instruction on the screen says to turn the IG off.

After the reprogramming has been completed, refer to Section XV and restore the vehicle.

XIII. IF UPDATE CALIBRATION FAILS



If the calibration fails contact your FTS for warranty claim filling instructions

1. REMOVE THE DCM (TELEMATICS TRANSCEIVER)

Go on TIS and refer to the repair manual for how to separate the seat

Path: CELLULAR COMMUNICATION / DCM(TELEMATICS TRANSCEIVER) / REMOVAL

Note: you can copy and paste the path above into the TIS search bar to access the instructions quickly

2. CONNECT THE TECHSTREAM TO THE DCM

- a) Using a Cable No.1 & No.2 (provided tool), connect the Techstream to the DCM.

NOTE: DO NOT use these tools except for this campaign.



Follow the instructions below. Otherwise, the battery voltage will decrease or communication will become disabled, and this may require the replacement of the DCM.

- Turn off the screen saver and power saving mode of the PC.
- Use the external power supply for the PC. (**DO NOT** use the PC's internal battery or vehicle's battery.)
- Ensure that the communication cable connectors are securely connected, the cable is in good condition, and the connection is stable.

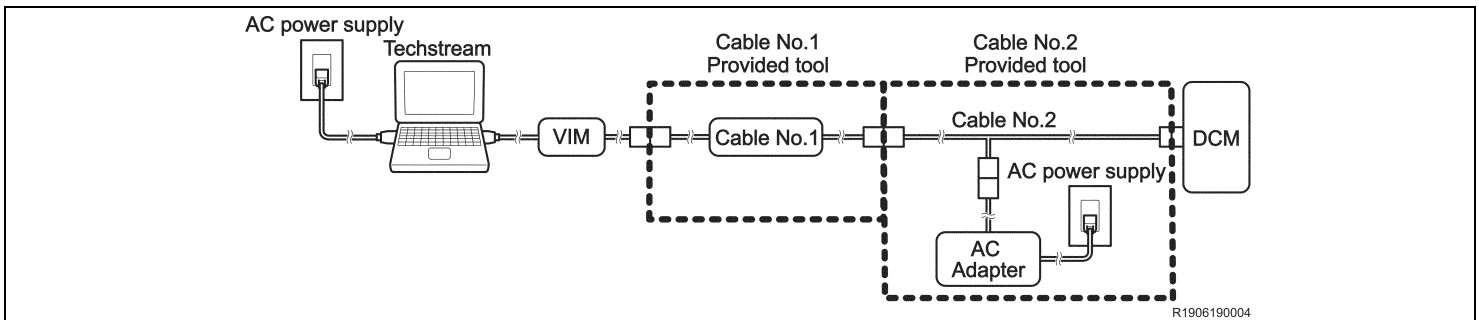

3. UPDATE THE TELEMATICS SYSTEM

a) Perform a Health Check.

NOTE:

- Only "Telematics" will be shown on the System column.
- Some DTCs may be shown but it does not affect the reprogramming.

Click the **NEW CID** link below to update the DCM

DCM(Telematics System) Calibrations		
DCM Model	Current CID	NEW CID
12DCM	00002. 40 .06.04.01.91	00002.80.06.04.01.91
13/14 VI-DCM	00003. 00 .05.01.03.16	00003.20.05.01.03.16
	00003. 00 .05.01.03.21	00003.20.05.01.03.21
	00003. 00 .05.01.13.02	00003.20.05.01.13.02
	00003. 00 .05.01.13.03	00003.20.05.01.13.03
	00003. 00 .05.01.13.04	00003.20.05.01.13.04
	00003. 00 .05.01.13.06	00003.20.05.01.13.06

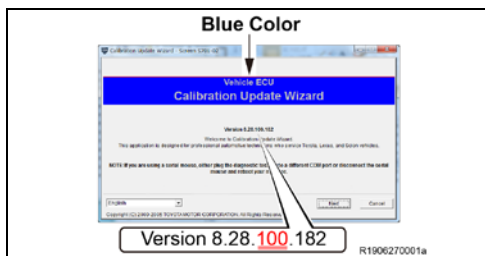

b) When Calibration Update Wizard is launched, click on "Next".

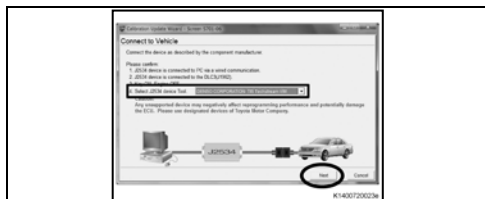

c) Select a device tool, and then click on "Next".

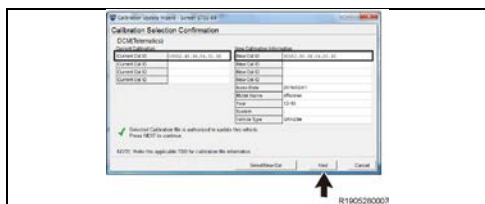

d) Confirm that "Current Cal ID" and "New Cal ID" are correct, and then click on "Next".

NOTE: The calibration IDs will be displayed as shown on the left. Please make sure you **DO NOT** mistake where to check to confirm the IDs.

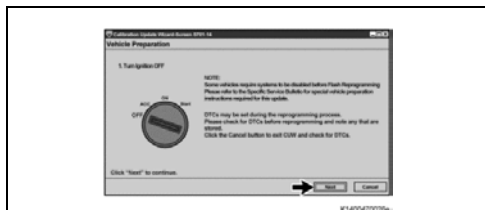

e) Click on "Next".

NOTE: It is **NOT** necessary to follow the instructions on the screen of Techstream.

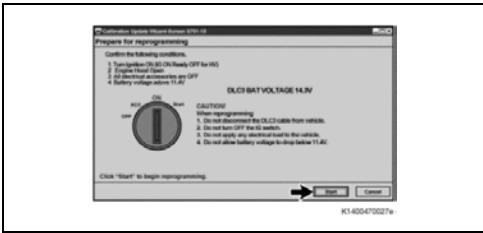

f) Click on “Start”.

NOTE: It is **NOT** necessary to follow the instructions on the screen of Techstream.

g) While reprogramming, the screen shown on the below is displayed.

NOTE:

As reprogramming completes within approximately 75 minutes (12DCM) or 85 minutes (13/14VI-DCM), stay near the vehicle and **DO NOT** allow any third parties to operate the vehicle or Techstream in order to prevent issues from occurring.

The following phenomena may be observed while reprogramming due to interrupted communication.

- “Now processing” is displayed for about 10 minutes. **DO NOT** finish reprogramming until the screen changes.

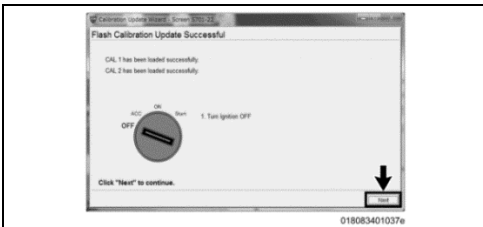
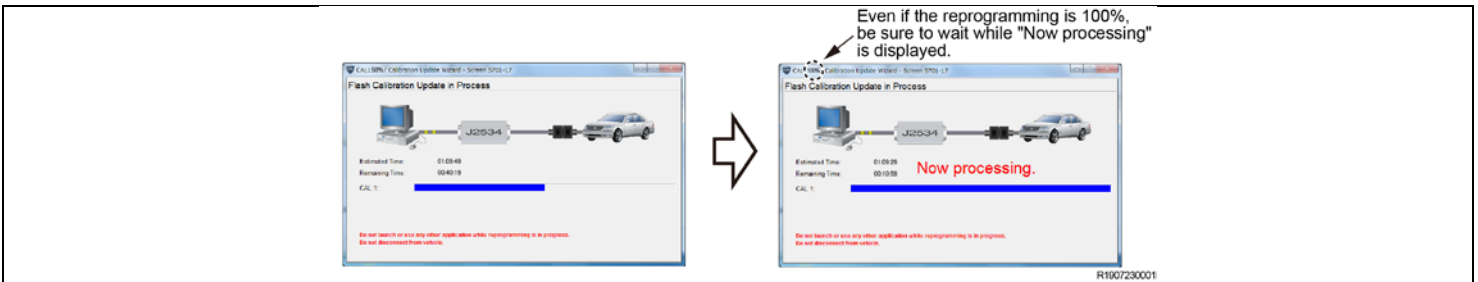

h) After “Flash Calibration Update Successful” is displayed, click the “Next” button.

NOTE: After “Next” is clicked, a bar showing the progress is displayed.

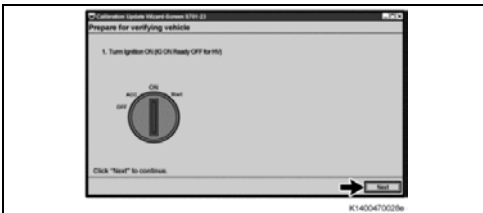

i) Click the “Next” button.

NOTE: It is **NOT** necessary to follow the instructions on the screen of Techstream.

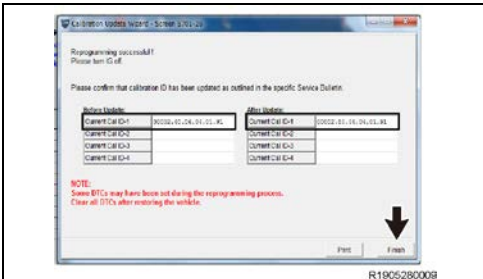

j) After reprogramming, make sure that the "After update "Current Cal ID" is correct.

k) Click the “Finish” button.



4. INSTALL THE DCM (TELEMATICS TRANSCEIVER)

Go on TIS and refer to the repair manual for how to separate the seat

Path: CELLULAR COMMUNICATION / DCM(TELEMATICS TRANSCEIVER) / INSTALLATION

Note: you can copy and paste the path above into the TIS search bar to access the instructions quickly

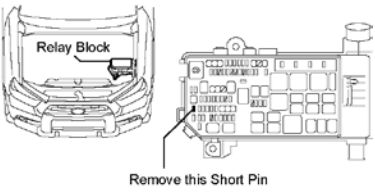
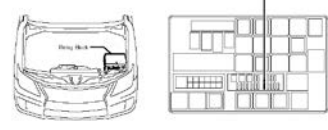
XIV. D/C CUT AND SHORT PIN LOCATION

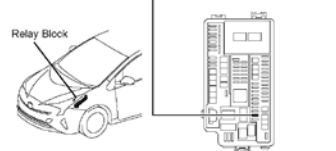
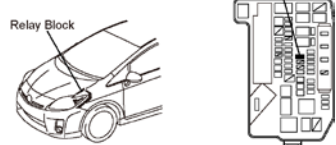
<p>4RUNNER (GRN28#)</p>  <p>Remove this Short Pin</p>	<p>LAND CRUISER (URJ200) Before Aug. 2015 Production</p>  <p>Remove Short Pin</p>
<p>LAND CRUISER (URJ200) After Aug. 2015 Production</p>  <p>Remove D/C CUT Fuse (30 A)</p>	<p>PRIUS (ZVW50)</p>  <p>Remove D/C CUT Fuse (25A)</p>
<p>PRIUS, PRIUS V (ZVW30, ZVW4#)</p>  <p>Remove this Short Pin</p>	

XV. COMPLETE REPAIR

1. DISCONNECT THE GR8/DCA
2. RESTORE THE VEHICLE (IF YOU REPROGRAM 12DCM)

- a) Reinstall the "D/C CUT FUSE" or "SHORT PIN".
- b) **(Only 4RUNNER, PRIUS, PRIUS V).**
 - (1) Disconnect cable from negative battery terminal.
 - (2) Connect each connector of the front passenger seat. Refer to repair manual for installation. Depending on seat type, you may need to perform certain initializations (such as Zero Point Calibration) refer to the repair manual for details
 - (3) Connect cable to negative battery terminal.
 - (4) Some systems need to be initialized after the cable is reconnected. Refer to repair manual for initialization.



3. PERFORM VERIFICATION HEALTH CHECK

- a) Using a Techstream, perform a Health Check.
- b) Clear DTC's that may have set during the re-flash procedure.
- c) Re-run the Health Check to confirm that no DTC's reappear.



THIS VERIFICATION HEALTH CHECK IS NECESSARY to update the results and CID's to the National database.

4. CONFIRM CID UPDATE

- a) On the Stored Data tab, confirm the following for the DCM:
The calibration ID is the latest version

5. PRINT CUSTOMER HEALTH CHECK REPORT

- a) From the Stored Data tab, select the Customer Health Check Report button (TIS will launch when button is pressed).

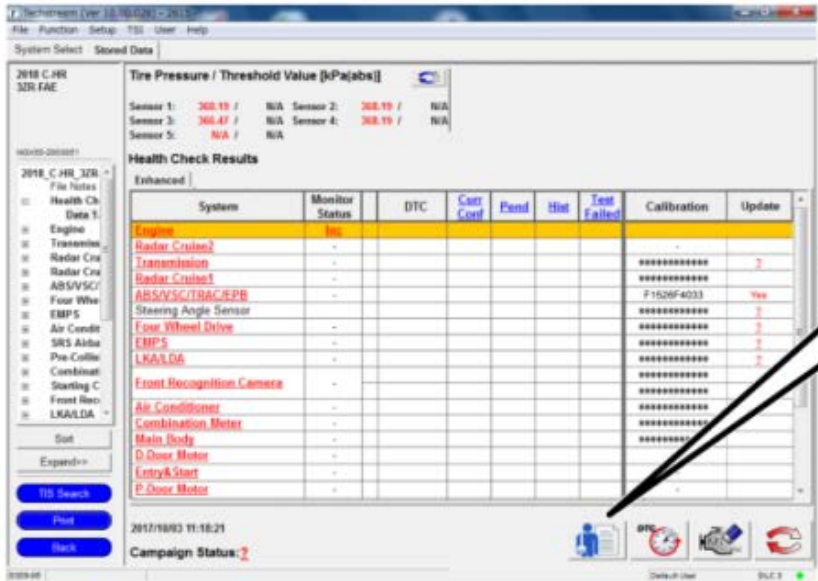

Customer Health Check Button

System	Monitor Status	DTC	Calibr	Perf	Hit	Test Failed	Calibration	Update
Engine	Inc							
Radar Cruise2	-							?
Transmission	-						*****	?
Radar Cru	-							?
ABS/ESC	-						*****	?
Four Whe	-						F1526F4033	Yes
EBPS	-						*****	?
Steering Angle Sensor	-						*****	?
Four Wheel Drive	-						*****	?
EMPS	-						*****	?
SRS Airba	-						*****	?
Pre-Collis	-						*****	?
LKA/LDA	-						*****	?
Front Recognition Camera	-						*****	?
Air Conditioner	-						*****	?
Combination Meter	-						*****	?
Main Body	-						*****	?
D-Over Motor	-						*****	?
Entry&Start	-						*****	?
P-Over Motor	-						*****	?

017346901019

- b) Log in to TIS.
- c) Input Vehicle Mileage and Repair Order number.
- d) Check the "Performed" campaign button for campaign K0P
- e) Select the Report button.

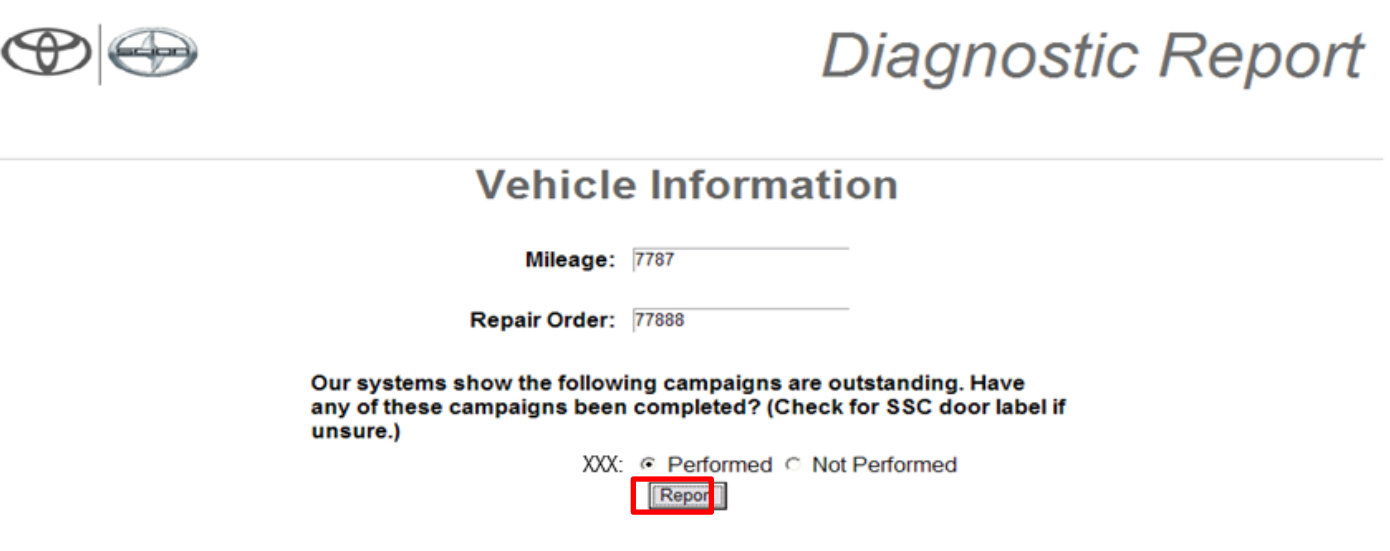

Diagnostic Report

Vehicle Information

Mileage: 7787

Repair Order: 77888

Our systems show the following campaigns are outstanding. Have any of these campaigns been completed? (Check for SSC door label if unsure.)

XXX: Performed Not Performed

Report

- f) Confirm Customer Health Check Report information is correct.
- g) Print Customer Health Check Report from TIS.
- h) Sign and provide to the customer.

NOTE:



If Service Mode screen is shown on the navigation screen, press OK to cancel service mode.

XVI. REINSTALL THE REGULAR CUW



Reinstall Regular CUW after Completion





1. RUN THE INSTALLER



1 → Regular CUW (except for DCM)
2 → Next

2. SELECT THE REGULAR CUW APPLICATION

- a) Select “Regular CUW (except for DCM)”.
- b) Click on the “Next” button to install the regular CUW application.

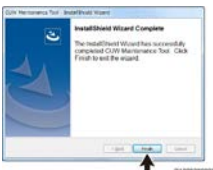

↑ Finish

3. COMPLETE INSTALLATION

- a) Click on the “Finish” button to finish.

NOTE: Use the regular CUW application after installing it to the personal computer which has Techstream.

◀ VERIFY REPAIR QUALITY ▶

- Confirm the calibration has been updated
- If the seat was removed, confirm it has been reinstalled correctly
- If the DCM was removed, confirm it has been reinstalled correctly

If you have any questions regarding this update, please contact your regional representative.

XVII. APPENDIX

A. CAMPAIGN DESIGNATION DECODER

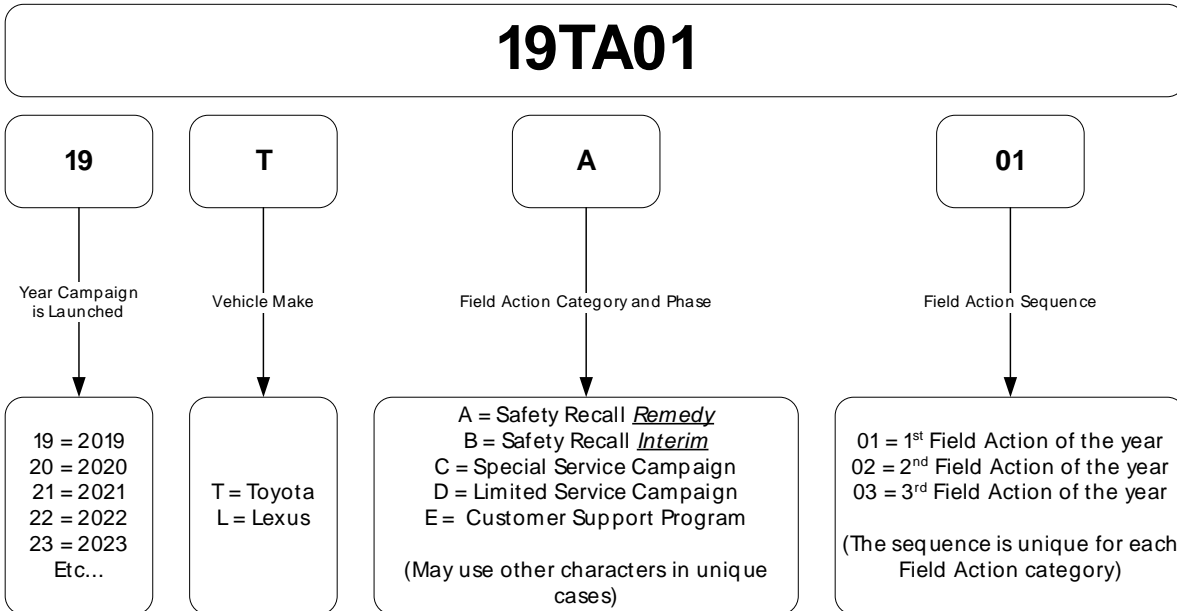
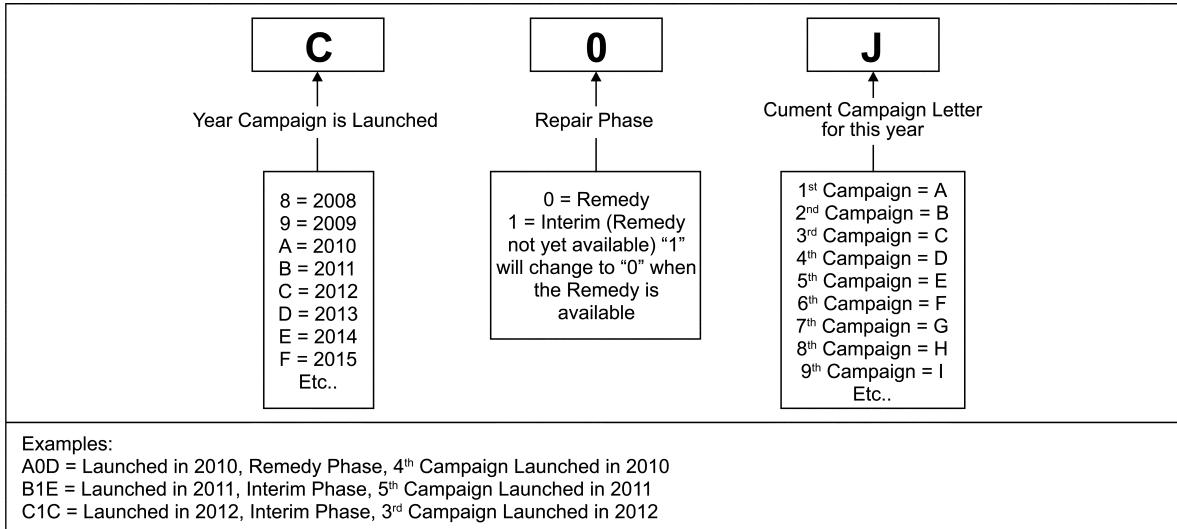

Examples:

- 19TA01 = Launched in 2019, Toyota, Safety Recall Remedy Phase, 1st Safety Recall Launched in 2019
- 20TC02 = Launched in 2020, Special Service Campaign, 2nd Special Service Campaign Launched in 2020
- 21TE05 = Launched in 2021, Customer Support Program, 5th Customer Support Program Launched in 2021

B. CAMPAIGN PARTS DISPOSAL

As required by Federal Regulations, please make sure all campaign parts (original parts) removed from the vehicle are disposed of in a manner in which they will not be reused, ***unless requested for parts recovery return.***