



TECHNICAL SERVICE BULLETIN High Roof Bus/Passenger Wagon - Headliner Loose Or Unseated At The C And/Or C 1/2 Pillar(s)

20-2341
29 September 2020

This bulletin supersedes 19-2108. Reason for update: Concern Carryover to New Model

Model:

| |
|----------------------------------|
| Ford 2015-2020 Transit |
|----------------------------------|

Summary

This article supersedes TSB 19-2108 to update the vehicle model years affected.

Issue: Some 2015-2020 Transit high roof bus/passenger wagon vehicles may experience a loose or unseated headliner at the C and/or C 1/2 pillar(s) causing visible gaps. This may be due to a lack of retention capability of the headliner locator tabs to the pillar block pins. To correct the condition, install repair coupons to the headliner and replace the headliner air conditioning (A/C) vent foam gaskets.

Action: Follow the Service Procedure steps to correct the condition on vehicles that meet all of the following criteria:

- 2015-2020 Transit
- Wagon/bus
- High roof
- Loose or unseated headliner at the C and/or C 1/2 pillar(s) causing visible gaps

NOTE: Part quantity refers to the number of that service part number required, which may be different than the number of individual pieces. Service part numbers contain 1 piece unless otherwise stated. "As Needed" indicates the part is required but the number may vary or is not a whole number; parts can be billed out as non-whole numbers, including less than 1.

Parts

| Part Number | | Description | Quantity |
|--|--|---------------------------------------|-----------|
| HK4Z-6152118-B | Package Contains 8 Pieces, 6 Pieces Required | Repair Coupon | 1 |
| HK4Z-61519B48-B | Package Contains 6 Pieces, 6 Pieces Required | A/C Vent Foam Gasket | 1 |
| Obtain Locally | - | 3M™ Super-Fast Repair Adhesive, 04747 | As Needed |
| Obtain Locally | 38191 For A 12 Pack Or 38193 For A 50 Pack | 3M™ Mixing Nozzles | As Needed |
| Parts To Inspect And Replace Only If Necessary | | | |
| W717918-SS34X | Package Contains 4 Pieces | Large Headliner Pushpin | If Needed |
| W706635-SS34X | Package Contains 4 Pieces | Small Headliner Pushpin | If Needed |

Warranty Status: Eligible under provisions of New Vehicle Limited Warranty (NVLW)/Service Part Warranty (SPW)/Special Service Part (SSP)/Extended Service Plan (ESP) coverage. Limits/policies/prior approvals are not altered by a TSB. NVLW/SPW/SSP/ESP coverage limits are determined by the identified causal part and verified using the OASIS part coverage tool.

Labor Times

| Description | Operation No. | Time |
|---|---------------|----------|
| 2015-2020 Transit High Roof: Install New A/C Vent Foam Gaskets And Repair Coupons Following The Service Procedure, Includes Time To Remove And Install Middle And Rear Sections Of Headliner (Do Not Use With Any Other Labor Operations) | 202341A | 1.8 Hrs. |

Repair/Claim Coding

| | |
|-----------------|---------|
| Causal Part: | 6151916 |
| Condition Code: | 33 |

Service Procedure

[Click here to view a video overview of this procedure.](#)



1. Does this vehicle have a high roof with a loose or unseated headliner causing a visible gap at the C and/or C 1/2 pillar(s), misalignment between headliner locator tab and pillar block pins? (Figures 1-3)

(1). Yes - proceed to Step 2.

(2). No - this article does not apply. Refer to Workshop Manual (WSM), Section 501-05 for normal diagnostics.

Figure 1

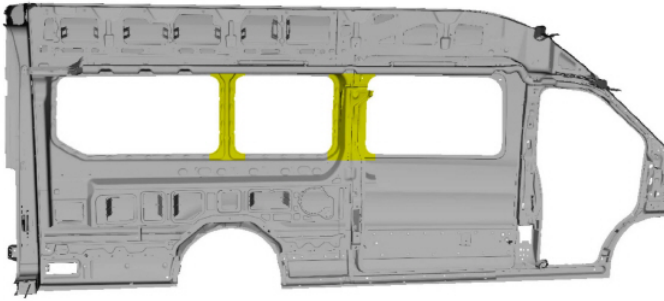

E306744

Figure 2

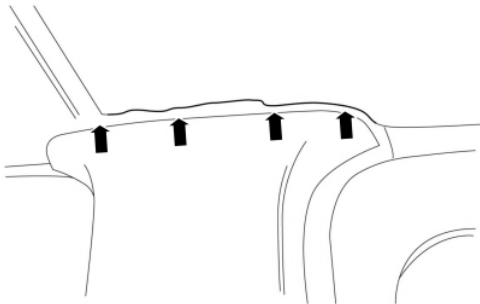

E306745

Figure 3

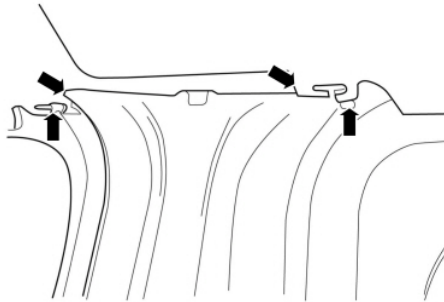

E306746

2. If equipped, remove the 5th row seats for easier access to the headliners.

3. Remove the middle and the rear headliner sections from the vehicle. Refer to Workshop Manual (WSM) Section 501-05, Removal and Installation, Rear Headliner. Do not remove the D-pillar trim panels or the seatbelt D-ring from vehicle as instructed in WSM, Section 501-05 Steps 1, 2, or 3. On a clean surface, stand the headliner on end.

4. Remove the A/C vent foam gaskets and residual glue by gently peeling them away from the backside of both headliner sections preserving the cloth headliner backing. (Figures 4-7)

Figure 4

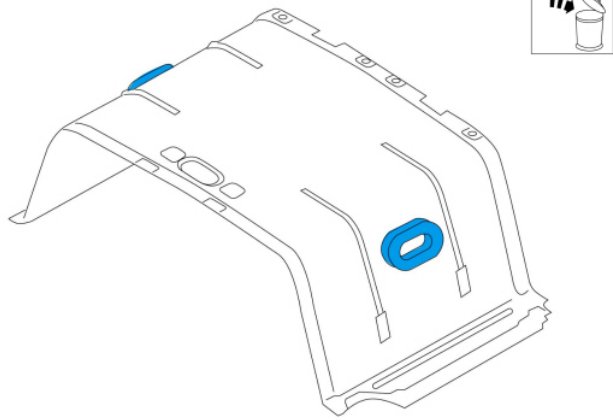

E306747
Figure 5

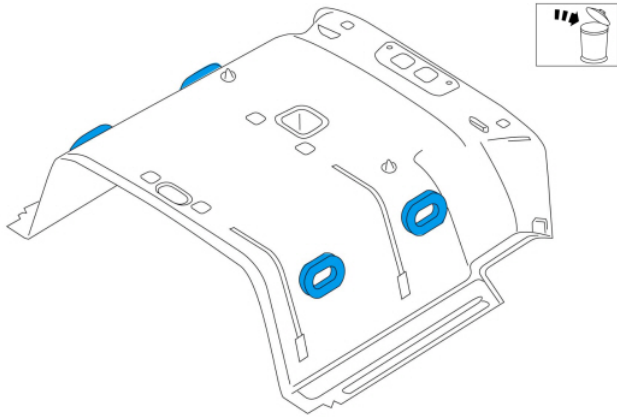

E306748
Figure 6

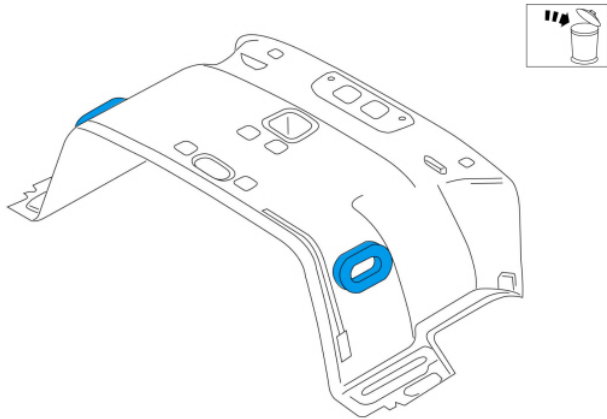

E306749
Figure 7



E306750

5. Install new A/C vent foam gaskets.

(1). Remove the protective paper cover from the new foam gasket to expose the adhesive film.

(2). With the adhesive facing the headliner substrate, place the gasket along the contact area around the vent and press firmly for 15 seconds to make sure the adhesion between the gasket and the headliner is secure. (Figure 8)

Figure 8

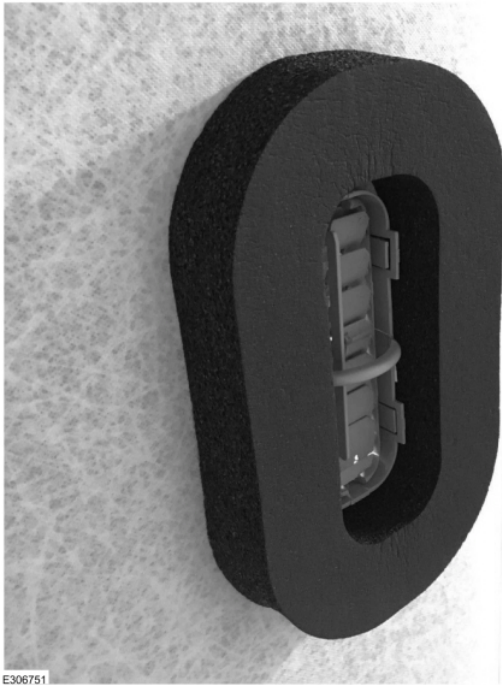

E306751

6. Using scissors or a sharp knife, remove the damaged, torn or bent locator tab ears from the six headliner attaching points. If the headliner has been repaired before, the prior cutline may vary slightly. Remove the old repair coupons and any retaining material, preserving the cloth backing. (Figures 9-10)

Figure 9

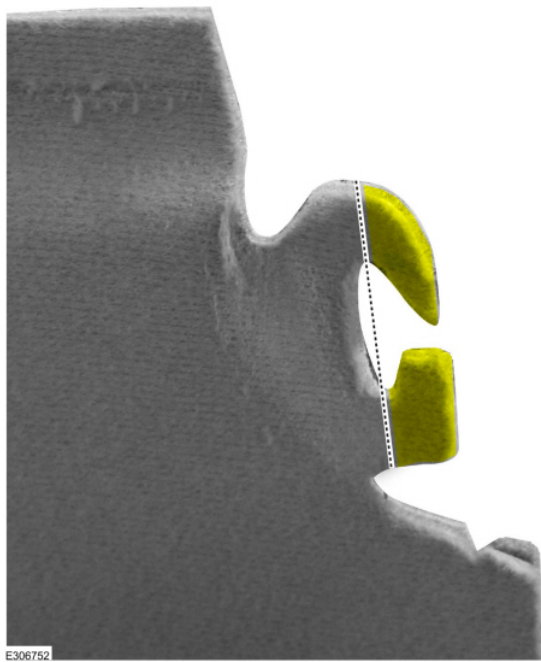

E306752

Figure 10

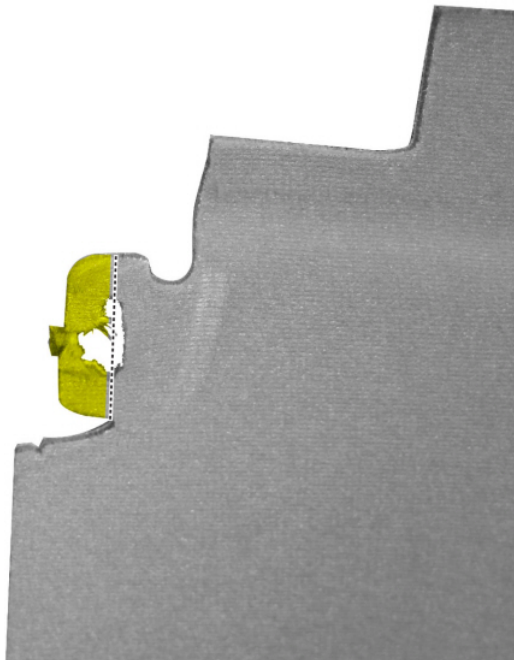

E306753



CAUTION: Two persons are required for the following step.

7. While the headliners are removed and with ends facing up, bend the headliner sidewall. Have one technician hold the top surface of the headliner to prevent any lateral side-to-side movement while the other technician uses light hand pressure to slowly bend the metal reinforcement bars slightly outward, stopping as soon as a slight bend to the bar is seen or felt. While performing this operation be careful not to apply excessive pressure as this will cause the substrate to crease, however some crackling noise will be audible during operation. Bend the driver and passenger side of each metal reinforcement bar on the removed headliner sections outward. (Figures 11-13)

(1).

Click here for the video link for further clarification of this Step



(same video as at the beginning of this article).

Figure 11



E306754

Figure 12



E306755

Figure 13

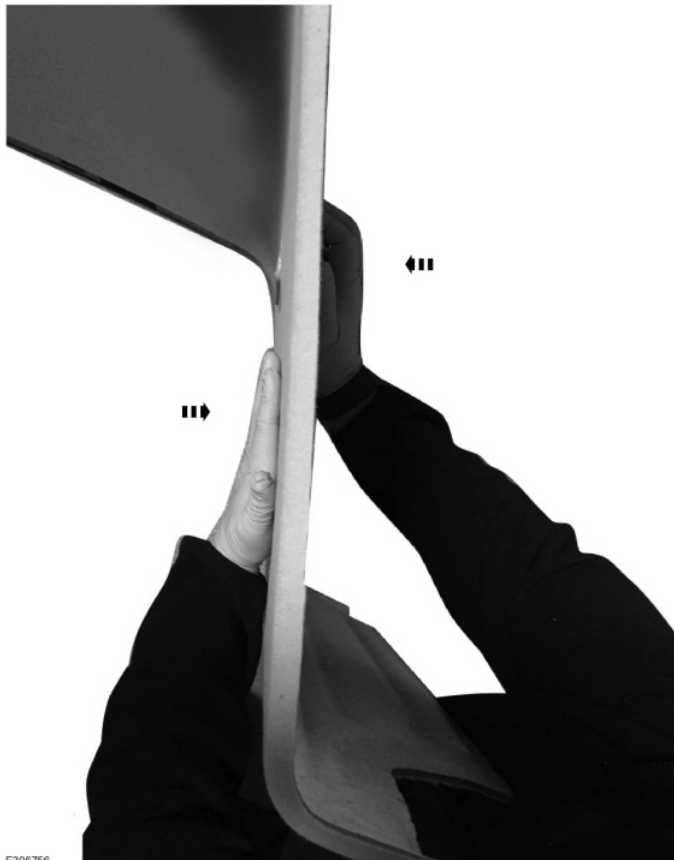

E306756

8. Before installing the headliners, use #150 or higher sandpaper, deburring tool, or a file to smooth sharp edges or flashing of the 6 pillar block pins for the headliner repair coupons. Remove all sharp edges before installing the headliner. (Figures 14-15)

Figure 14



E306757

Figure 15

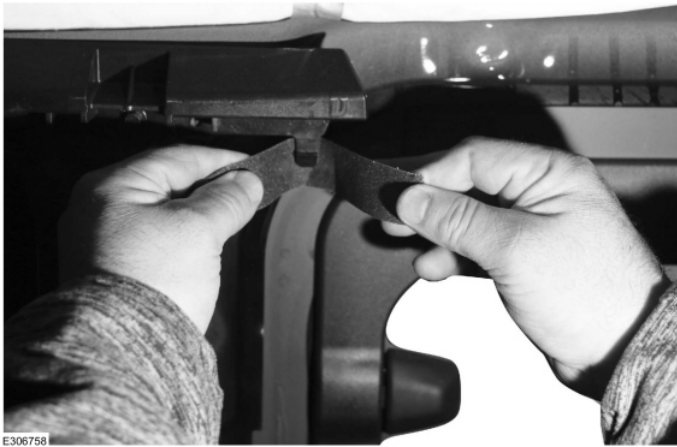

E306758

9. Install the middle and the rear headliner sections. Refer to WSM, Section 501-05. Do not install the C and/or the C 1/2-pillar trim panels at this time.
10. Using a straightedge, mark the 6 new repair coupons with a centerline from the pillar pin slot to the V notch on the bottom. This will be used for headliner alignment. (Figure 16)

Figure 16



E306759

11. Carefully install the 6 repair coupons on the 6 pillar block pins, with the centerline mark facing down. (Figure 17)

Figure 17

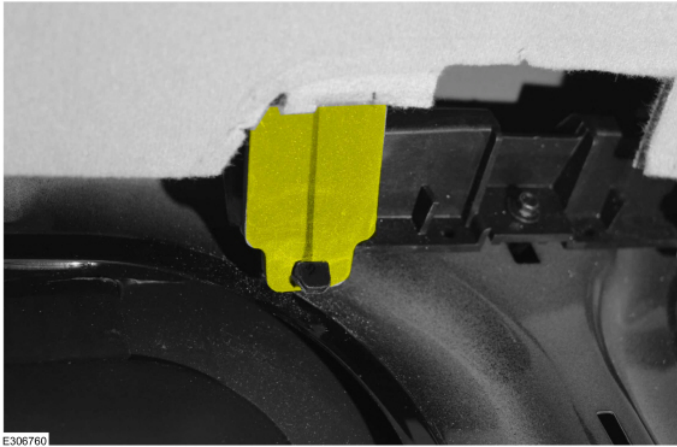

12. Push the headliner outward until it contacts sheet metal and hold it, noting its position and fit to the side glass. Using a marker, place a small mark at the edge of the headliner where the centerline of the repair coupon meets it. (Figure 18)

Figure 18



13. While the headliner is still being held in position, draw a line across the repair coupon (perpendicular to the center line) where it meets the headliner. If a previous repair was performed and more than just the ears of the headliner attaching point were removed during Step 6, more of the repair coupon besides the slot will be exposed. The crossline is added for optimum alignment. (Figure 19)

Figure 19

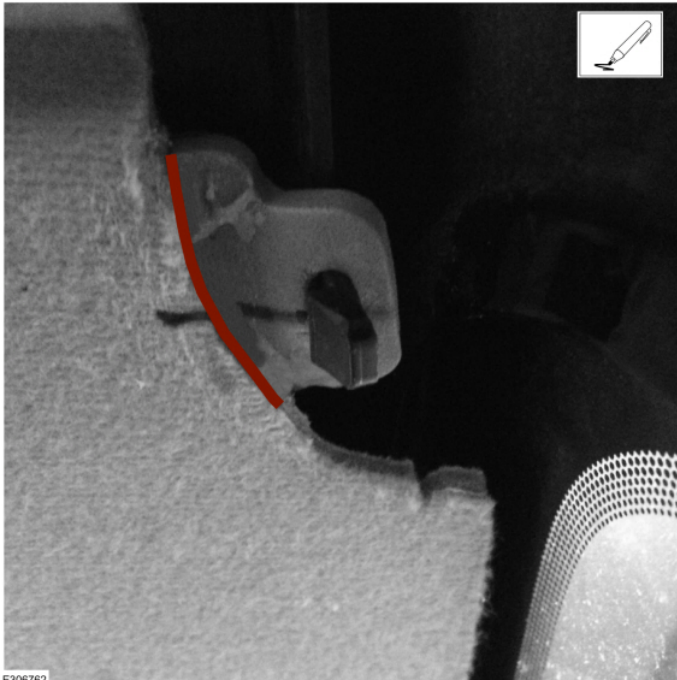

14. Carefully remove the repair coupons from the pillar block pins, noting which pillar block pin location applies to the corresponding repair coupon.

NOTE: The 3M™ adhesive used in this procedure will clog the mixing nozzle within approximately 15 seconds after use. Additional nozzles will be required. Use protective gloves to prevent glue from skin contact. A second person can secure a retaining coupon at the same time.

15. Attach the repair coupons to the headliner.

- (1). Apply a generous bead of the 3M™ adhesive to the repair coupon without extending onto the ear or past the added headliner alignment line from Step 13. (Figure 20)
- (2). Quickly install the repair coupon to the top of the headliner, lining up the repair coupon centerline with the mark from Step 10 on the headliner. Also align the headliner with the crossline on the repair coupon from Step 13.
- (3). Apply pressure for 20 seconds. Do not attach the repair coupon to the pillar block pins at this time. The adhesive must be allowed to cure.
- (4). Perform this step for all 6 repair coupons.

Figure 20



16. Allow the adhesive to cure for 10 minutes. While the repair coupons are curing, install the 5th row seats, if removed.

17. While holding the headliner in place, gently install the repair coupons onto the pillar block pins. (Figure 21)

Figure 21

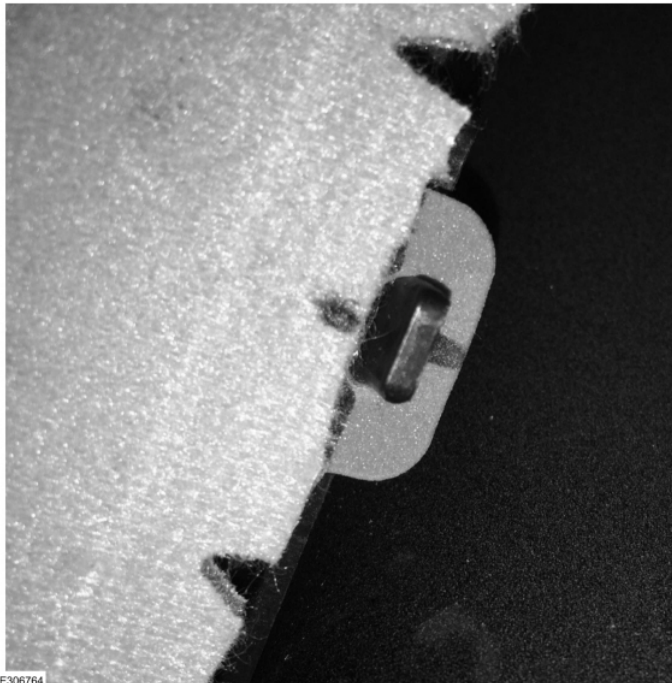

18. Install the C and C 1/2 pillar trim panels.

© 2020 Ford Motor Company
All rights reserved.

NOTE: The information in Technical Service Bulletins is intended for use by trained, professional technicians with the knowledge, tools, and equipment to do the job properly and safely. It informs these technicians of conditions that may occur on some vehicles, or provides information that could assist in proper vehicle service. The procedures should not be performed by "do-it-yourselfers". Do not assume that a condition described affects your car or truck. Contact a Ford or Lincoln dealership to determine whether the Bulletin applies to your vehicle. Warranty Policy and Extended Service Plan documentation determine Warranty and/or Extended Service Plan coverage unless stated otherwise in the TSB article. The information in this Technical Service Bulletin (TSB) was current at the time of printing. Ford Motor Company reserves the right to supersede this information with updates. The most recent information is available through Ford Motor Company's on-line technical resources.