



SERVICE BULLETIN

Classification:

BT19-009b

Reference:

NTB19-059b

Date:

November 17, 2020

MOONROOF RATTLE

This bulletin has been amended. See **AMENDMENT HISTORY** on the last page.
Please discard previous versions of this bulletin.

APPLIED VEHICLES: 2016-2020 Maxima (A36)

IF YOU CONFIRM

Customer reports

- A rattle noise from the moonroof when driving with the moonroof open

OR

- An abnormal noise when opening/closing the Moonroof.

ACTION

1. Inspect for a broken anti-rattle clip located on the left and right rear link assembly.
2. Replace anti-rattle clip(s) as needed.

IMPORTANT: The purpose of ACTION (above) is to give you a quick idea of the work you will be performing. You **MUST** closely follow the entire **SERVICE PROCEDURE** as it contains information that is essential to successfully completing this repair.

Nissan Bulletins are intended for use by qualified technicians, not 'do-it-yourselfers'. Qualified technicians are properly trained individuals who have the equipment, tools, safety instruction, and know-how to do a job properly and safely. NOTE: If you believe that a described condition may apply to a particular vehicle, **DO NOT** assume that it does. See your Nissan dealer to determine if this applies to your vehicle.

SERVICE PROCEDURE

NOTE: This procedure applies to the left and right side of the moonroof. Repair one side at a time and repeat the steps for the other side when instructed to do so. The photos are for reference only. Some of the photos are of the left side of the vehicle and some are of the right side of the vehicle.

You will inspect and, if necessary, replace the rear link with an anti-rattle clip assembly. See Figure 1 and Figure 2 below to become familiar with these components.



Figure 1

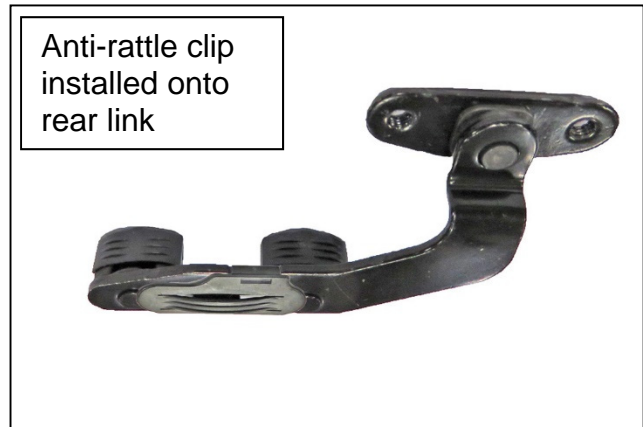

Figure 2

1. Inspect for a broken anti-rattle clip.
 - a. Use a finesse stick to lift the roof finisher seal to access the Moonroof rail.

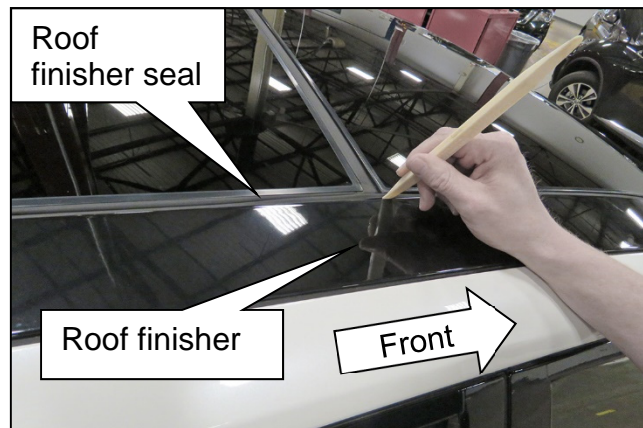

Figure 3

2. Inspect the Moonroof rail area outlined in red for pieces of the anti-rattle clip.

- Repeat steps 1 and 2 on the other side of the Moonroof.
- If pieces are found, continue to step 3 on the next page.

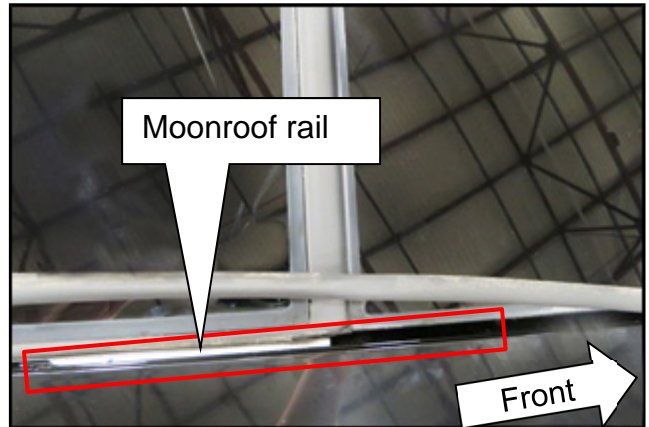

Figure 4

- If no pieces are found, operate the Moonroof to the tilt position and inspect the anti-rattle clip installation on the rear link.
- Refer to Figure 5 for an example of a GOOD anti-rattle clip. If no pieces of the anti-rattle clip (outlined in red) are missing or broken, this bulletin does not apply. Refer to the ESM for further information.
- If any part outlined in red is missing or damaged, continue to step 3 on the next page.

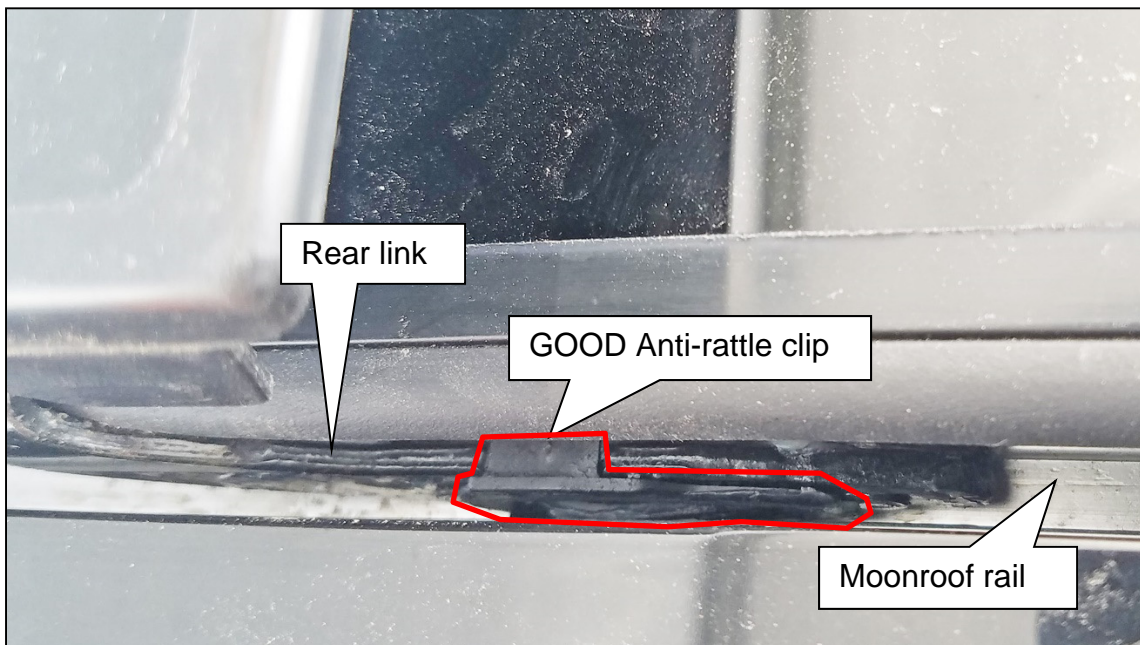

Figure 5

3. Remove the roof finisher seal by slowly lifting UP.

HINT: Performing this procedure on a warm vehicle will assist in removal.

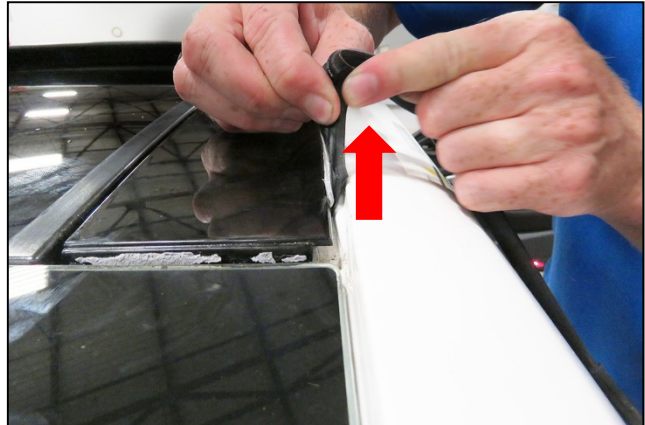

Figure 6

4. Open the Moonroof.

5. Remove the inboard screw (single use T25) securing the front of the roof finisher.

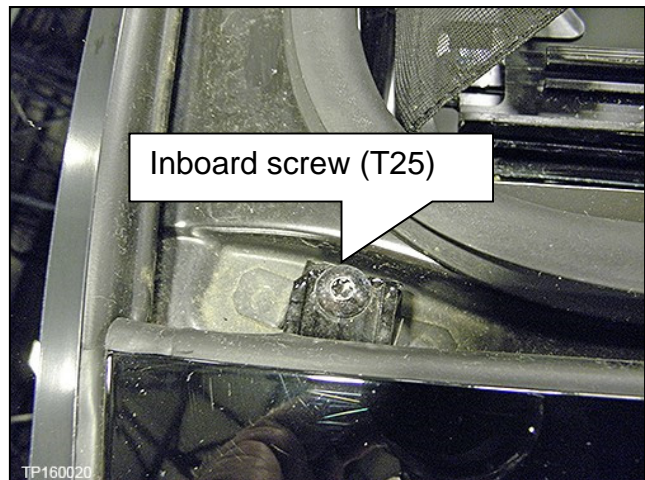

Figure 7

6. Using a finesse stick, lift the roof finisher at the front outside edge.

7. Slide the finesse stick down the length of the outside edge of the roof finisher to detach all the pins.

8. Remove the roof finisher.

NOTE: Some vehicles were equipped with adhesive under the roof finishers.

- If the roof finisher released, continue to step 14 on page 8.
- If the roof finisher will not release after the pins have been detached, cut away any adhesive as described in steps 9 - 13 starting on the next page.



Figure 8

9. Cut adhesive from the roof finisher.
- The red dotted line indicates where the adhesive will be cut in the next step.

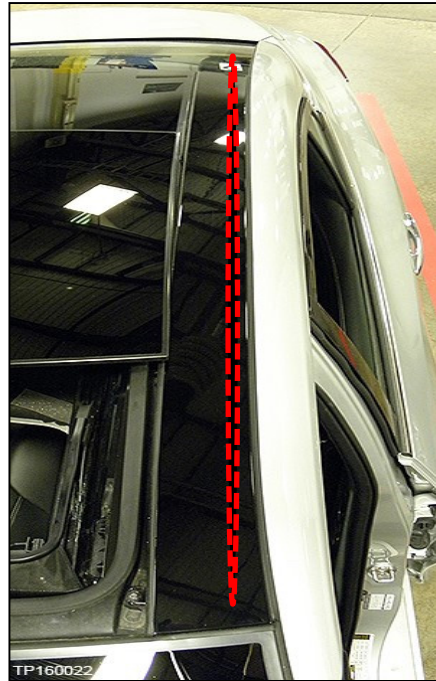

Figure 9

10. Using a suitable adhesive cutting tool and starting at the front, cut the adhesive between the roof finisher and roof.

CAUTION: Apply tape on the roof to avoid damage to the painted surfaces.

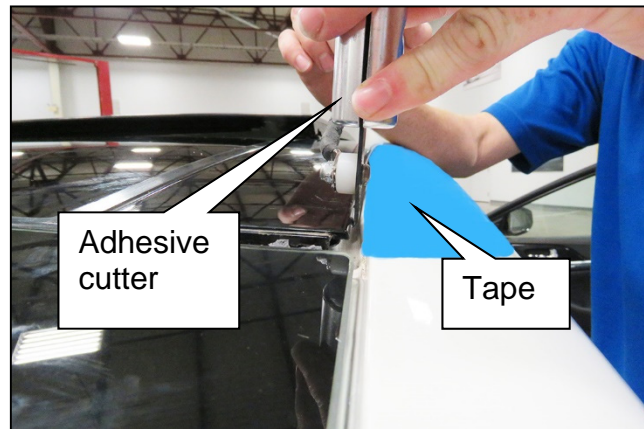

Figure 10

NOTE: It may be necessary to perform this step more than once to cut through all of the adhesive.



Figure 11

11. Using a finesse stick, lift the roof finisher at the front outside edge.
12. Slide finesse stick down the length of the outside edge of the roof finisher to detach all the pins.
13. If the roof finisher will still not release after the pins have been released, cut away any adhesive under the roof finisher indicated by the green circles as shown in Figure 12.

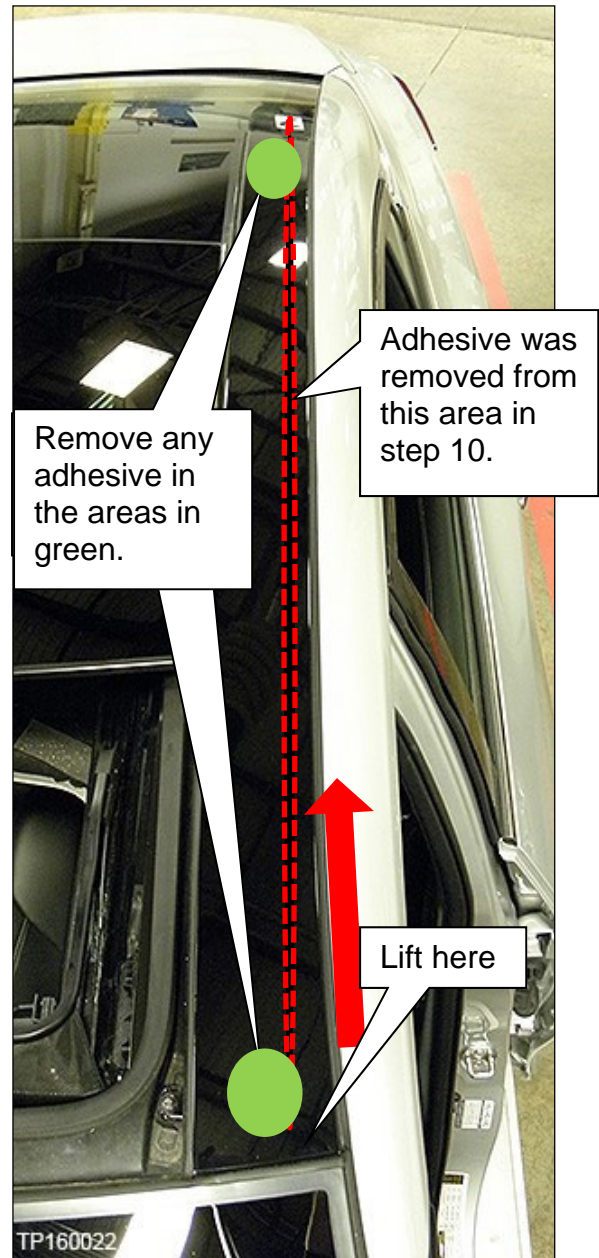

Figure 12

- 14. Turn the ignition ON.
- 15. Operate the Moonroof to the tilt position.
- 16. Remove the Moonroof bolt finisher.

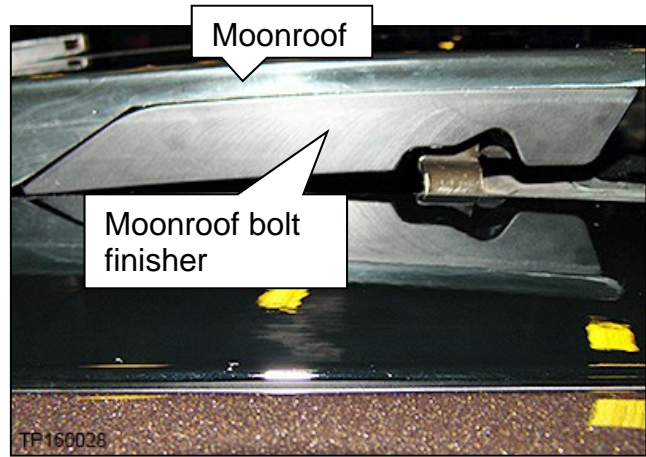

Figure 13

- a. Pull the Moonroof bolt finisher tab (plastic tab) down and away from the Moonroof and allow it to rest in the lowered position.

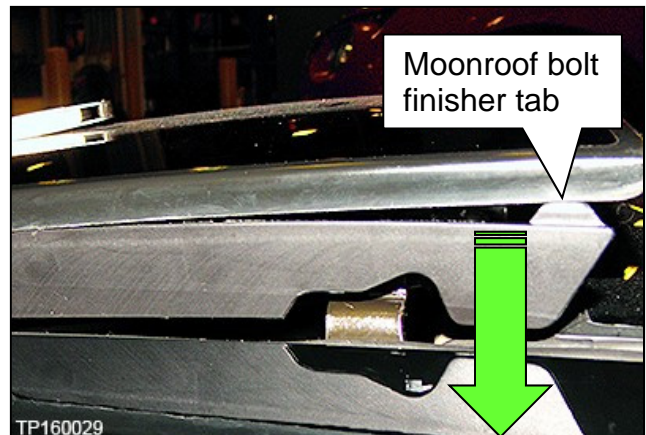

Figure 14

- b. Insert a pocket screw driver between the Moonroof bolt finisher and the Moonroof in the location shown in Figure 15.
- c. Apply slight downward force to the plastic tab end of the Moonroof bolt finisher until the hole through the steel tab can be seen.
- d. Slide the pocket screw driver from the plastic tab up to the hole in the steel tab that the Moonroof release clip is connected to.

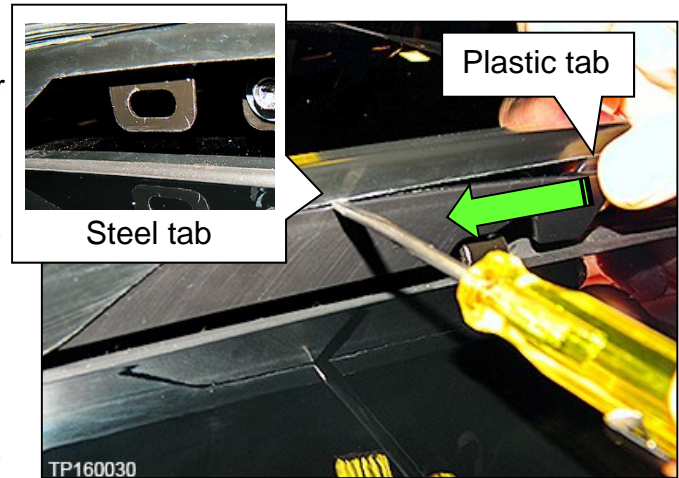

Figure 15

17. Insert the pocket screw driver through the hole in the steel tab to release the retaining clip.
 - Figure 17 shows how the retaining clip is released.

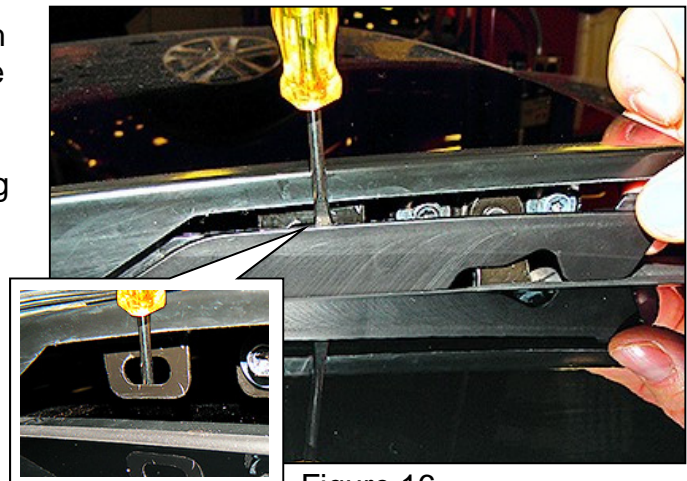

Figure 16

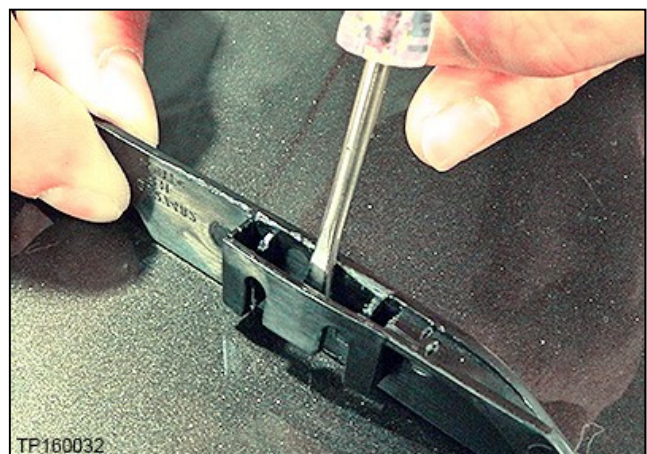

Figure 17

18. Remove the 2 (two) Moonroof adjustment bolts from the rear link.

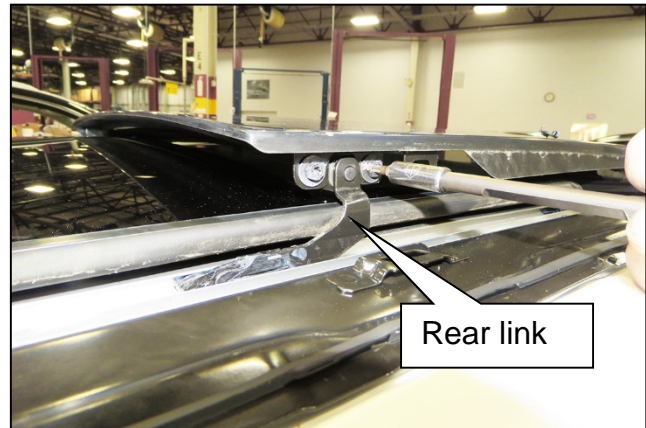

Figure 18

19. Slide the rear link toward the rear of the vehicle and out of the Moonroof rail.

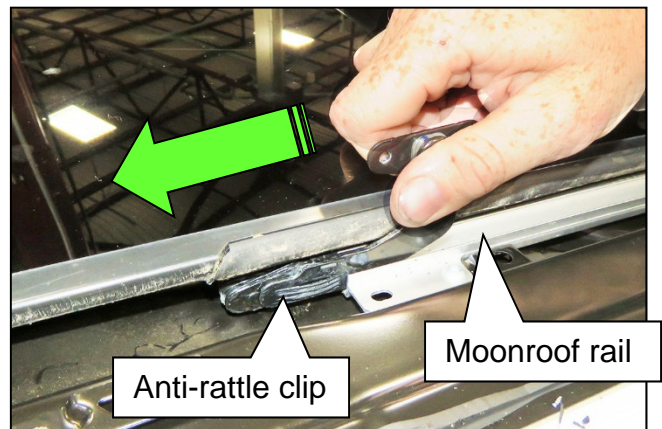

Figure 19

20. Remove any debris / anti-rattle clip material from the Moonroof rail area, outlined in red in Figure 20.

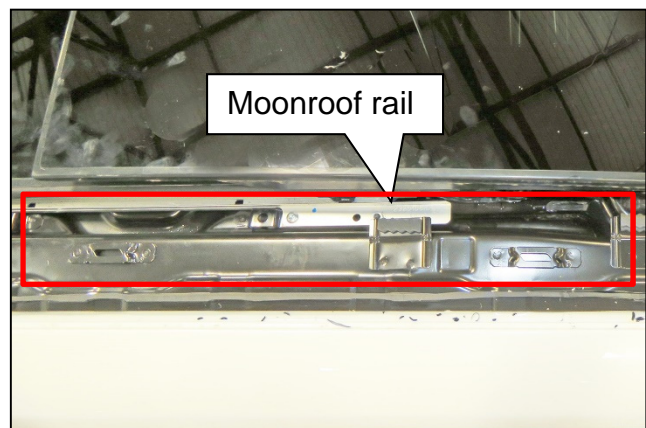

Figure 20

21. Install the rear link into the Moonroof rail.

NOTE: Spacers are present on the updated rear link.

NOTE: The guide pads on the rear link must compress to fit inside of the Moonroof rail.

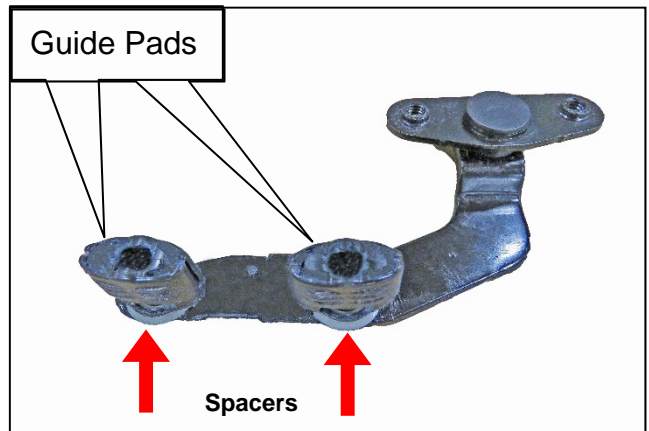

Figure 21

- a. Gently compress the forward most guide pad to insert it into the Moonroof rail.
- b. Gently compress the anti-rattle clip while applying slight pressure toward the front of the vehicle.

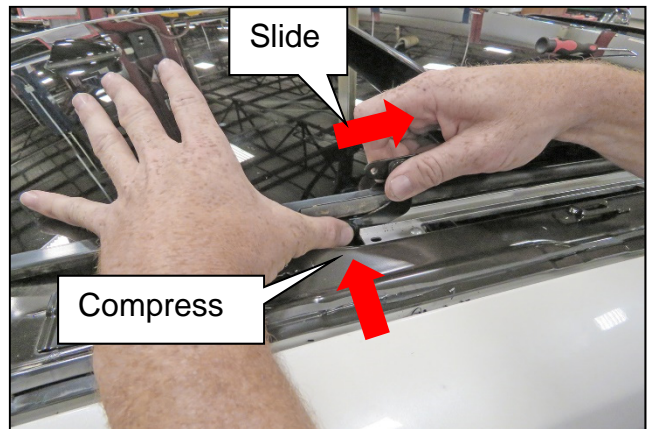

Figure 22

- c. Using a 90 degree pick behind the guide pad can assist in compressing the rearmost pad into the rear link.

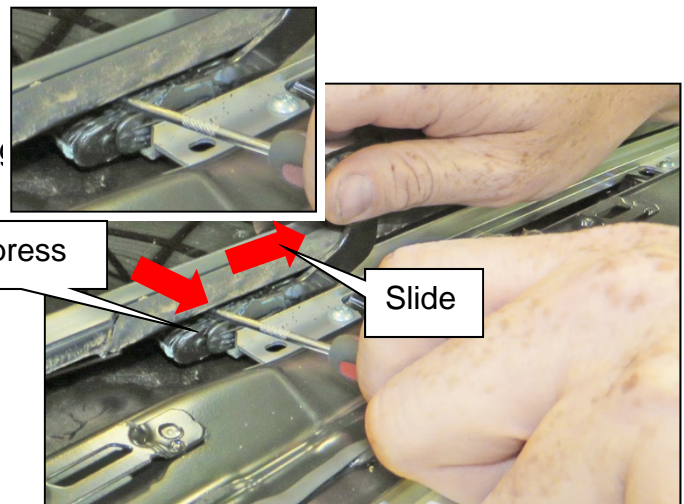

Figure 23

- d. Continue applying slight pressure toward the front of the vehicle.

22. Align the rear link mounting holes with the witness marks to assist in Moonroof alignment.

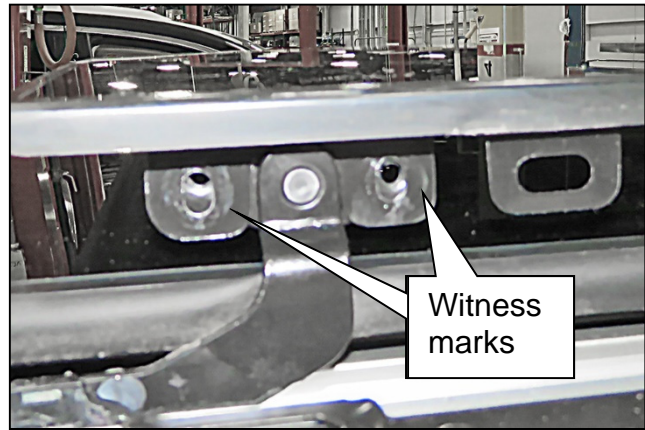

Figure 24

23. Repeat steps 3 - 22 for the other side of the Moonroof if replacing both anti-rattle clips.

24. Adjust the glass height to the proper position.

- Refer to **Moonroof Adjustment Clearances** on the next page.

NOTE:

- The Moonroof adjustment bolts should be slightly snug, not tight, to allow adjustments.
- Work one side at a time to raise and lower individual corners.
- If the Moonroof needs to be moved fore/aft, loosen all the adjustment bolts to adjust.

25. Tighten the adjustment bolts.

- Torque bolts to: 5.5 N•m (0.56 kg-m, **48.68 in-lb.**)

IMPORTANT:

- Make sure that the rear link is level.
- Figure 25 is shown with the screws removed to overemphasize incorrect pivot angle.

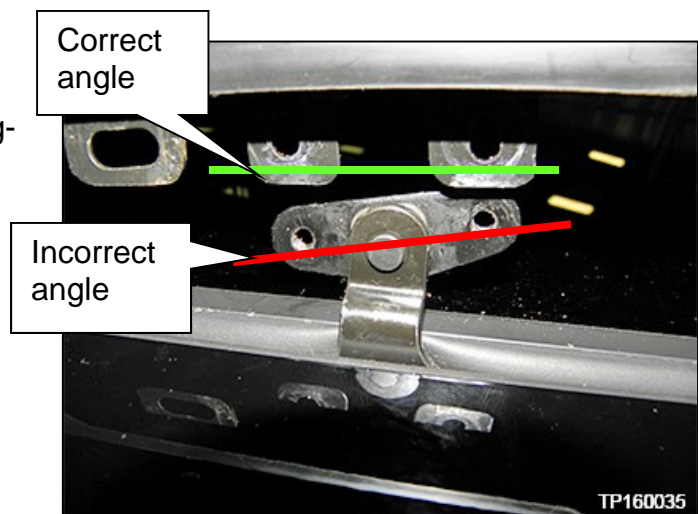
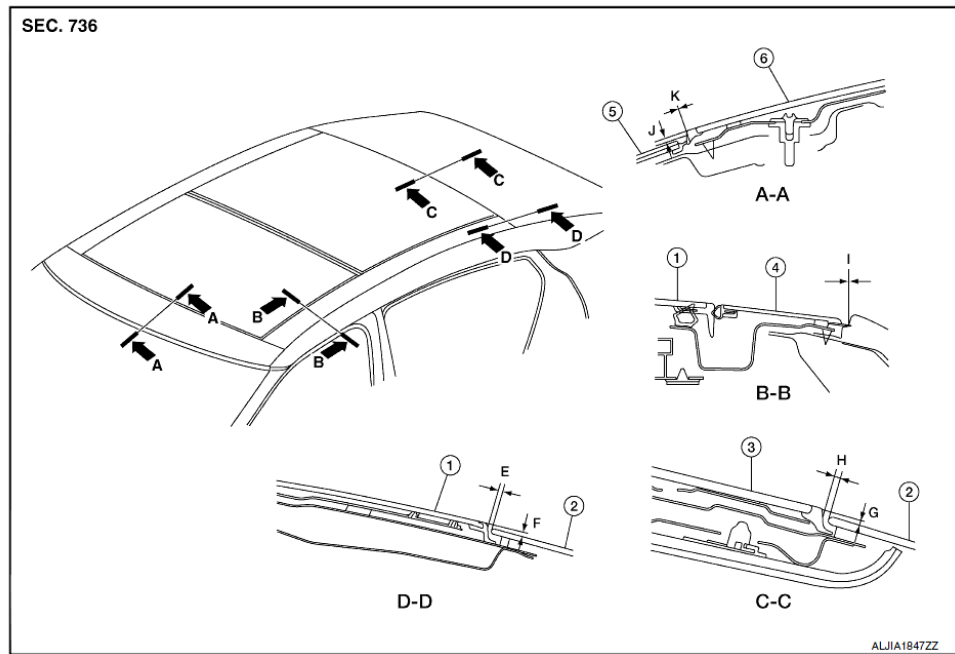

Figure 25

Moonroof Adjustment Clearances



Unit: mm (in)

1. Glass lid	2. Rear window glass	3. Rear moonroof glass
4. Roof side finisher	5. Windshield	6. Front moonroof glass
E. 3.0 ± 2.2 (0.118 \pm 0.087)	F. 2.7 ± 2.0 (0.106 \pm 0.079)	G. $2.0 + 2.2 - 1.7$ (0.079 + 0.087 - 0.067)
H. 3.0 ± 2.1 (0.118 \pm 0.083)	I. 0.0 (No clearance)	J. 4.5 ± 2.0 (0.177 \pm 0.079)
K. 0.0 (No clearance)		

26. Close the Moonroof and check adjustment.

27. Remove the old roof finisher adhesive from the vehicle.

NOTE: Any remaining adhesive residue similar to Figure 26 is acceptable.



Figure 26

28. Thoroughly clean the bonding area on the Moonroof frame and body with isopropyl alcohol or equivalent cleaner.

29. Prepare the tip of Betaseal™ 57302N Urethane Adhesive or equivalent.



Figure 27

NOTE:

- To properly install the adhesive, cut a notch in the tip similar to the one shown in Figure 28.



Figure 28

- Using a power caulk tool similar to the one shown in Figure 29 will aid in adhesive installation.



Figure 29

30. Add adhesive to the same locations as the old adhesive.

Adhesive applied thickness (A):
.5 inch (13 mm)

Adhesive applied width (B):
.3 inch (8 mm) wide

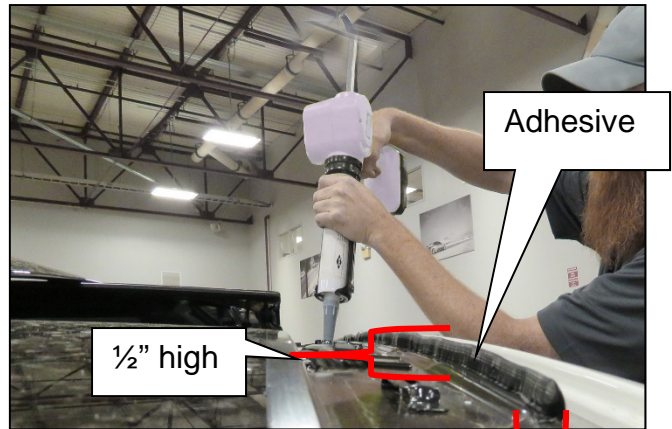
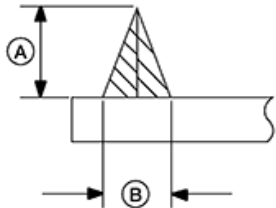

Figure 30

.3" wide

31. Verify the 3 roof finisher pins and 5 spacers have not become separated during roof finisher removal.

- Reinstall any pins or clips that have become separated.
- Verify the 2 rearmost pins are centered in their slots.

NOTE: The forward most pin slot has no adjustment and will fit only 1 way.

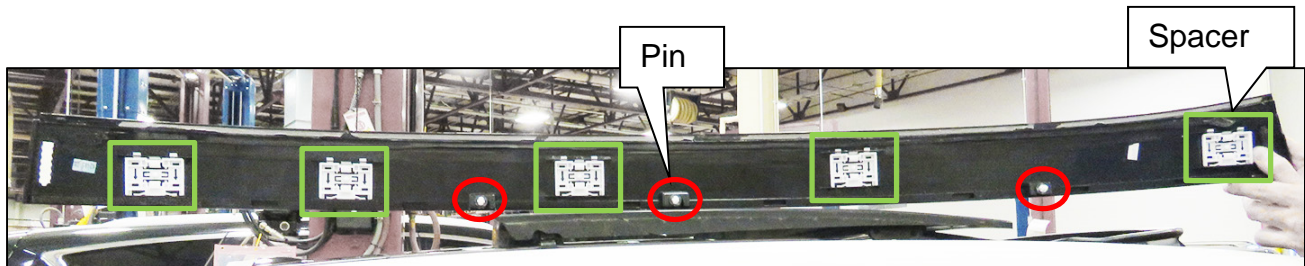

Figure 31

32. Tuck the roof finisher outer seal UNDER the windshield glass seal.

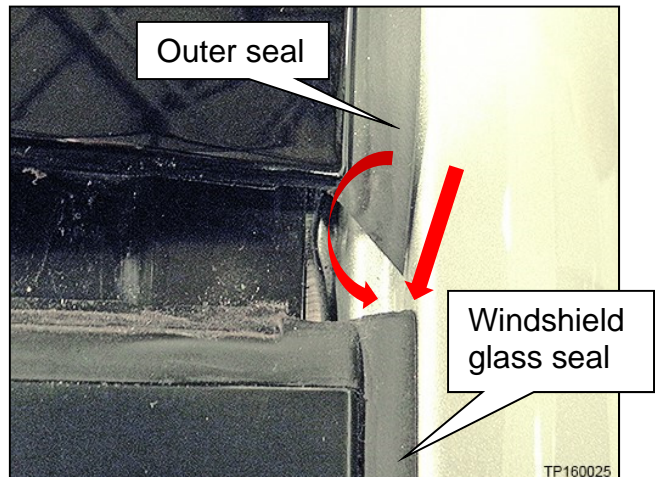

Figure 32

33. Starting from the front of the vehicle and moving rearward, attach each push pin to the roof.

34. After the push pins are all attached, seat all the square clips.

NOTE: Excess urethane sealant can hold the roof finisher out of position at the ends and not allow it to be seated. Trimming the extra urethane sealant will sometimes relieve the condition and allow it to seat.

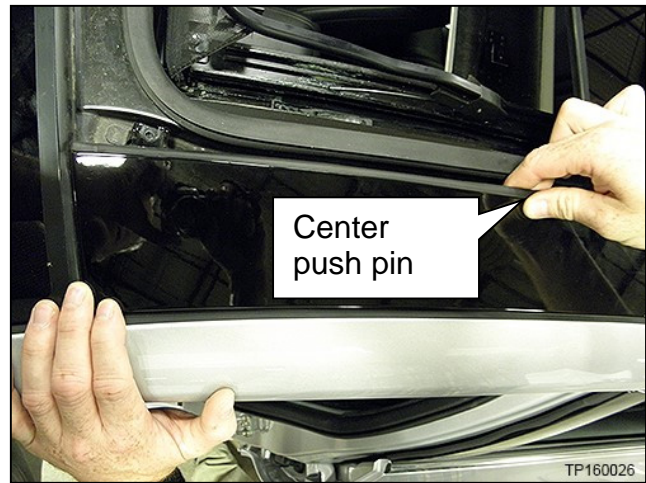

Figure 33

35. Tuck the rear roof finisher seal under the rear window glass.

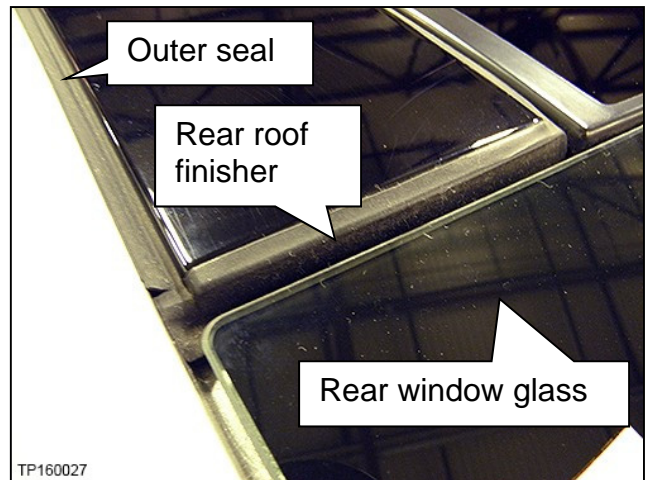

Figure 34

36. Open the Moonroof.

37. Install the **NEW** T25 inboard screw into the front of the roof finisher.

- Torque to: 2.5 N•m (0.255 kg-m, **22 in-lb.**)

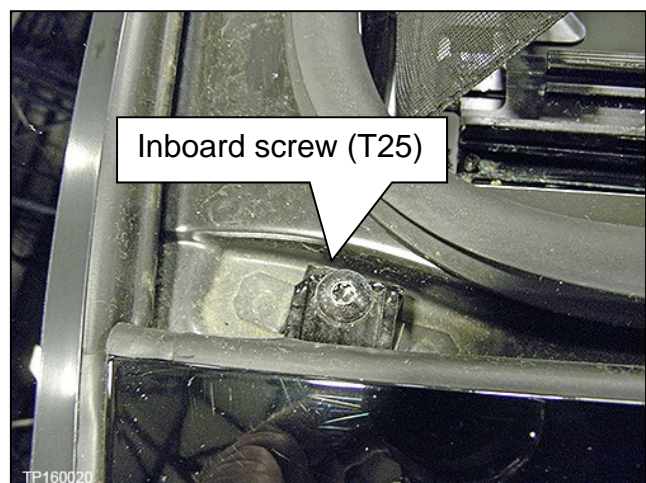

Figure 35

38. Use a finesse tool to tuck the new roof finisher seal into its channel.



Figure 36

39. Operate the Moonroof to the tilt position.
40. Position the new bolt finisher as shown in Figure 37.

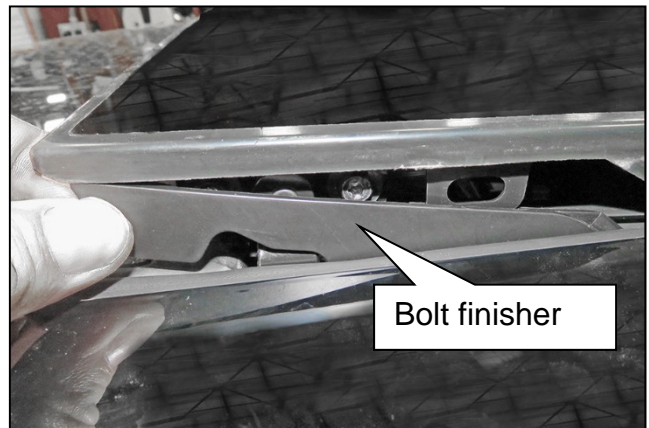

Figure 37

41. Use a finesse stick to lift the bolt finisher UP into position.

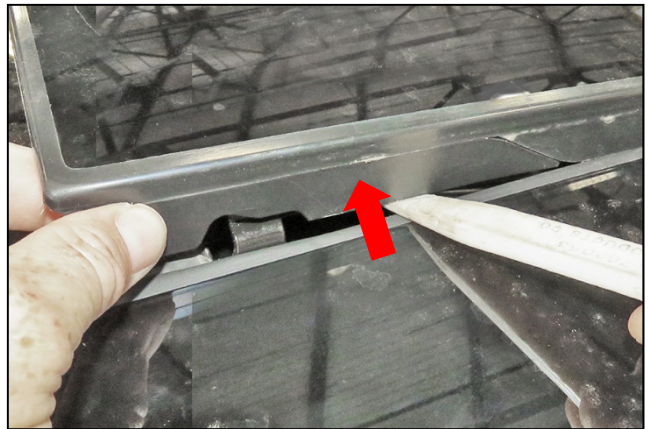

Figure 38

42. Repeat steps 27 - 41 for the other side of the Moonroof if replacing both anti-rattle clips.
43. Inspect the Moonroof, glass, roof finishers, and surrounding areas for cosmetic damage or adhesive residue.
44. Allow the adhesive to cure for approximately 24 hours.

PARTS INFORMATION

Right Side (If Needed)

DESCRIPTION	PART NUMBER	QUANTITY
FINISHER ASSY-ROOF, RH (1)	91760-4RA3A	1
LINK ASSY - GUIDE, RH	91554-9DL1A	1
PLATE - SUNROOF COVER, RH	91262-4RA3A	1
Urethane adhesive (2)	Betaseal™ 57302N Urethane Adhesive or equivalent	As needed

- (1) This part also includes one single use T25 screw.
- (2) The DOW® automotive chemical Betaseal™ 57302N Urethane Adhesive is recommended. Equivalent products may be used.

Left Side (If Needed)

DESCRIPTION	PART NUMBER	QUANTITY
FINISHER ASSY-ROOF, LH (1)	91761-4RA3A	1
LINK ASSY - GUIDE, LH	91555-9DL0A	1
PLATE - SUNROOF COVER, LH	91263-4RA3A	1
Urethane adhesive (2)	Betaseal™ 57302N Urethane Adhesive or equivalent	As needed

- (1) This part also includes one single use T25 screw.
- (2) The DOW® automotive chemical Betaseal™ 57302N Urethane Adhesive is recommended. Equivalent products may be used.

CLAIMS INFORMATION

Submit a Primary Part (PP) type line claim using the following claims coding:

DESCRIPTION	PFP	OP CODE	SYM	DIA	FRT
Replace Guide & Link Assembly	(1)	UQ22AA (2)	ZE	32	(3)

- (1) Reference the electronic parts catalog and use the Guide Link Assembly as the Primary Failed Part (PFP).
- (2) If both Right and Left side Link Assemblies are replaced, each side must be submitted on a different Work Order Line.
- (3) Reference the current Nissan Warranty Flat Rate Manual and use the indicated Flat Rate Time (FRT).

Expense code:

EXPENSE CODE	DESCRIPTION	MAX AMOUNT
067	Urethane adhesive	\$4.95

AMENDMENT HISTORY

PUBLISHED DATE	REFERENCE	DESCRIPTION
August 1, 2019	NTB19-059	Original bulletin published
May 5, 2020	NTB19-059a	APPLIED VEHICLES updated
November 17, 2020	NTB19-059b	Updated PARTS INFORMATION and CLAIMS INFORMATION