

# Driveline Vibration Under Deceleration Around 30 - 10 mph

**Service Category** Drivetrain

**Section** Drive Shaft/Propeller Shaft

**Market** USA

Toyota Supports  
 ASE Certification 

## Applicability

YEAR(S)	MODEL(S)	ADDITIONAL INFORMATION
2016 - 2021	Tacoma	VDS(s): CZ5AN, GZ5AN, SZ5AN Engine(s): 2GR Drive Type(s): 4WD Transmission(s): 6AT

### **SUPERSESSON NOTICE**

The information contained in this bulletin supersedes Service Bulletin No. T-SB-0071-19.

- Applicability has been updated to include 2020 – 2021 model year Tacoma vehicles.
- The entire bulletin has been updated.

Service Bulletin No. T-SB-0071-19 is obsolete and any printed versions should be discarded.

## Introduction

Some 2016 – 2021 model year Tacoma vehicles equipped with an automatic transmission may exhibit a vibration under deceleration (coasting or braking) between 30 – 10 mph. This vibration is felt in the seat, floorboard, and/or steering wheel. Follow the Repair Procedure in this bulletin to address this condition.

### **NOTE**

- This Service Bulletin ONLY applies to 4WD models equipped with 6AT. Do NOT use the spring part number found in the Service Bulletin for ANY manual transmission vehicles or PreRunner models. This could lead to NEW, currently nonexistent issues.
- If the vehicle is installed with an aftermarket suspension/body lift or leveling kit, this Service Bulletin does NOT apply.

## Driveline Vibration Under Deceleration Around 30 - 10 mph

---

### Production Change Information

- This bulletin applies to all 2016 – 2021 model year Tacoma vehicles NOT equipped with the TRD Off-Road package option.
- This bulletin applies to 2016 model year Tacoma vehicles equipped with the TRD Off-Road package option produced **BEFORE** the Production Change Effective VINs shown below.

CAB TYPE	PRODUCTION CHANGE EFFECTIVE VIN
Double	5TFGZ5AN#GX040536
	3TMGZ5AN#GM039554
	5TFCZ5AN#GX040121
	3TMCZ5AN#GM039538
Access	5TFSZ5AN#GX017523

#### NOTE

ALL TRD Off-Road package vehicles produced AFTER the effective VIN change use the same springs in production as the countermeasure part numbers listed in this Service Bulletin. Do NOT follow this Service Bulletin for TRD Off-Road equipped vehicles produced AFTER production change effective VINs provided in the production change information table.

## Driveline Vibration Under Deceleration Around 30 - 10 mph

---

### Warranty Information

OP CODE	DESCRIPTION	TIME	OFP	T1	T2
SU1903	Install Steering Wheel Damper and Measure Joint Angle	1.1 (Damper = 0.6) (Measure Angles = 0.5)	45816-60030		
SU1904	Install Steering Wheel Damper, Measure Joint Angle, and R & R Leaf Springs	2.1	48210-04700 48210-04701 48210-04810 48210-04811 48210-04710 48210-04711 48220-04340 48220-04341 48220-04450 48220-04451 48220-04350 48220-04351	9B	57

#### APPLICABLE WARRANTY

- This repair is covered under the Toyota Basic Warranty. This warranty is in effect for 36 months or 36,000 miles, whichever occurs first, from the vehicle's in-service date.
- Warranty application is limited to occurrence of the specified condition described in this bulletin.

## Driveline Vibration Under Deceleration Around 30 - 10 mph

### Parts Information

CAB TYPE	PART NUMBER		PART NAME	QTY
	PREVIOUS	NEW		
Double	48210-04700	48210-04840	Spring Assy, RR RH	1
	48210-04701			
	48210-04810			
	48210-04811			
	48210-04710			
	48210-04711			
	48220-04340	48220-04480	Spring Assy, RR LH	1
	48220-04341			
	48220-04450			
	48220-04451			
	48220-04350			
	48220-04351			
Access	48210-04700	48210-04830	Spring Assy, RR RH	1
	48210-04701			
	48210-04810			
	48210-04811			
	48210-04710			
	48210-04711			
	48220-04340	48220-04470	Spring Assy, RR LH	1
	48220-04341			
	48220-04450			
	48220-04451			
	48220-04350			
	48220-04351			
All	45713-35040		Damper, Steering Shake	1
	90080-15079		Screw, With Washer	2

### Required Tools & Equipment

SPECIAL SERVICE TOOLS (SST)	PART NUMBER	QTY
Digital Angle Gauge*	<a href="#">01815-00102</a>	1

\*Essential SST.

**NOTE**  
Additional SSTs may be ordered by calling 1-800-933-8335.

## Driveline Vibration Under Deceleration Around 30 - 10 mph

---

### Repair Procedure

1. Confirm the condition exists.
  - A. Does the vehicle exhibit a vibration under deceleration (coasting or braking) between 30 – 10 mph?
    - **YES** — Continue to substep B.
    - **NO** — This bulletin does NOT apply. Continue diagnosis using the applicable Repair Manual.
  - B. Use the following method to determine if the driveline vibration is normal or if this bulletin applies.
    - (1) Remove the rear driveshaft.
    - (2) Shift into 4WD HI.
    - (3) Test-drive the vehicle.
 After using that method, does the vehicle exhibit a vibration?
    - **YES** — This bulletin does NOT apply. Continue diagnosis using the applicable Repair Manual.
    - **NO** — Continue to step 2.
2. Remove the steering wheel pad.

**CAUTION**

**Wait at LEAST 90 seconds AFTER disconnecting the cable from the negative (–) battery terminal to disable the SRS system.**

Refer to the TIS, applicable model and model year Repair Manual:

- [2016](#) / [2017](#) / [2018](#) / [2019](#) / [2020](#) / [2021](#) Tacoma:  
*Vehicle Interior – Supplemental Restraint Systems* – “Supplemental Restraint Systems: Steering Pad: Removal”

## Driveline Vibration Under Deceleration Around 30 - 10 mph

### Repair Procedure (continued)

- Remove the steering wheel switch wire harness retainer bracket (ONLY for vehicles with steering wheel mounted switches).

**Figure 1.**

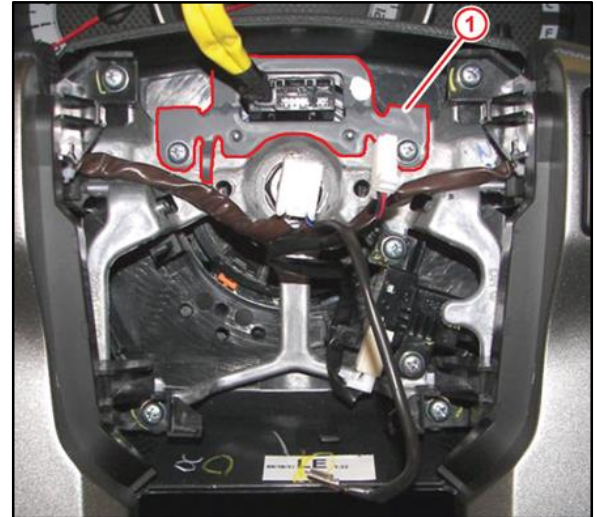

<b>1</b>	<b>Steering Wheel Switch Wire Harness Retainer Bracket</b>
----------	--

- Install the steering wheel damper using two NEW screws in the locations shown.  
**Torque: 2.35 N\*m (24 kgf\*cm, 20.8 in\*lbf)**

**NOTICE**  
When disconnecting ANY airbag connector, take care not to damage the airbag wire harness.

**NOTE**  
Secure the steering wheel switch wires to the steering wheel damper bracket hooks as shown.

**Figure 2.**

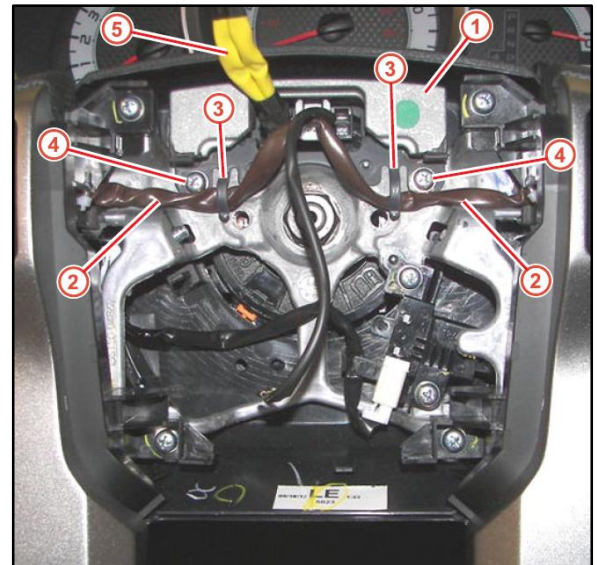

<b>1</b>	<b>Damper</b>
<b>2</b>	<b>Steering Wheel Switch Wire Harness</b>
<b>3</b>	<b>Damper Bracket Wire Retainer Hook</b>
<b>4</b>	<b>Screw</b>
<b>5</b>	<b>Driver Side Airbag Wire Harness</b>

## Driveline Vibration Under Deceleration Around 30 - 10 mph

### Repair Procedure (continued)

5. Install the steering wheel pad.

Refer to TIS, applicable model and model year Repair Manual:

- [2016](#) / [2017](#) / [2018](#) / [2019](#) / [2020](#) / [2021](#) Tacoma:  
*Vehicle Interior – Supplemental Restraint Systems – “Supplemental Restraint Systems: Steering Pad: Installation”*

6. Raise the vehicle using a drive-on hoist or wheel alignment rack.

**NOTE**  
 Vehicle suspension MUST be at ride height.

7. Set up the digital angle gauge.

- A. Clean the gauge mounting surfaces of ANY dust and debris.
- B. Place the gauge with the screen facing the passenger side of the vehicle up/down.

**NOTE**  
 The digital angle gauge is directional and must be placed with the screen facing the passenger side of the vehicle for the up/down indicator to properly display the angle. The tool indicates a positive or negative angle based on the right side of the tools vertical location.

- C. Power on the digital angle gauge and set it to “Absolute Mode.” ABS will be displayed in the upper right corner of the display as shown in Figure 3.

**Figure 3. Digital Angle Gauge**



<b>1</b>	<b>Indicates Absolute Mode</b>
----------	--------------------------------

## Driveline Vibration Under Deceleration Around 30 - 10 mph

### Repair Procedure (continued)

8. Verify which flange type the vehicle is equipped with.
  - Large flange (Figure 4) — Continue to step 9.
  - Small flange (Figure 5) — Go to step 10.

**NOTE**  
 Make sure to wipe off the area BEFORE taking the pinion flange measurement.

**Figure 4.**

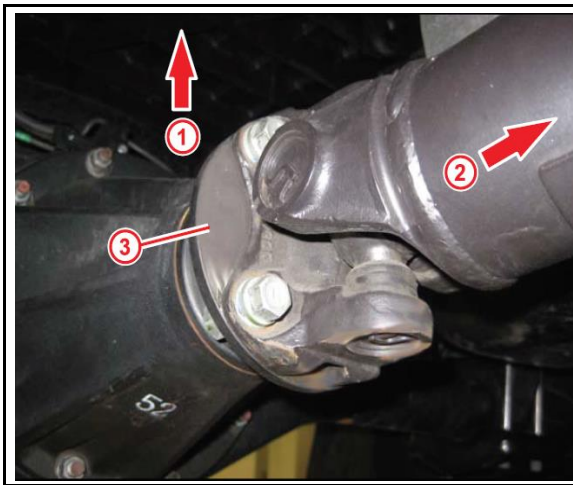

<b>1</b>	Up
<b>2</b>	Front
<b>3</b>	Large Flange

**Figure 5.**

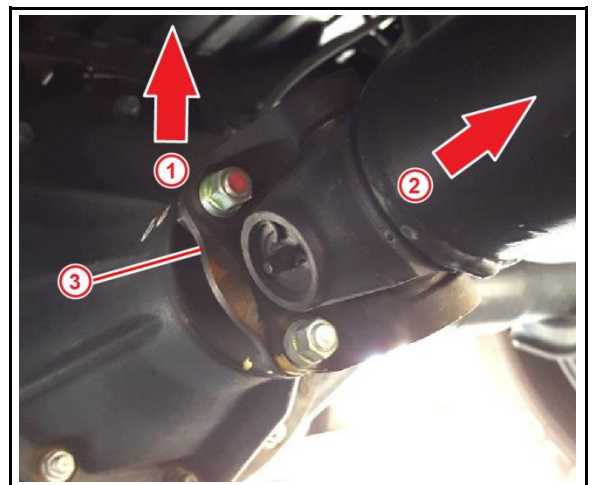

<b>1</b>	Up
<b>2</b>	Front
<b>3</b>	Small Flange



## Driveline Vibration Under Deceleration Around 30 - 10 mph

### Repair Procedure (continued)

9. Measure the pinion flange angle (F/A) — **Large Flange Type.**
  - A. Place the digital angle gauge against the flange surface.
    - (1) Ensure the digital angle gauge is firmly against the flange to obtain an accurate pinion flange angle as shown in Figure 6.

**Figure 6. Gauge Placement in Relation to Vehicle**

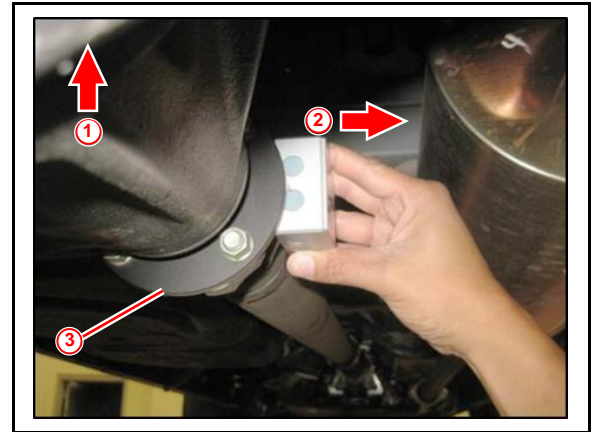

<b>1</b>	<b>Up</b>
<b>2</b>	<b>Passenger Side of Vehicle</b>
<b>3</b>	<b>Pinion Flange</b>

- (2) Record the pinion flange angle (F/A).

**Figure 7.**



## Driveline Vibration Under Deceleration Around 30 - 10 mph

---

### Repair Procedure (continued)

10. Measure the pinion flange angle (F/A) — **Small Flange Type.**

A. Remove the propeller shaft.

Refer to TIS, applicable model and model year Repair Manual:

- 2016 – 2021 Tacoma:

*Engine/Hybrid System – Propeller Shaft* – [“Propeller Shaft: Propeller Shaft Assembly \(for 4WD\): Removal”](#)

B. Place the digital angle gauge against the flange surface.

Ensure the digital angle gauge is firmly against the flange to obtain an accurate pinion flange angle as shown.

**Figure 8.**

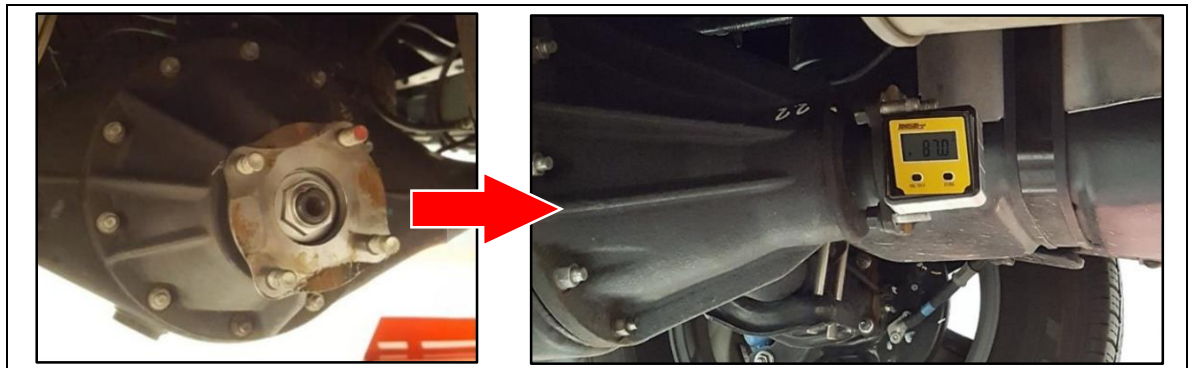

## Driveline Vibration Under Deceleration Around 30 - 10 mph

### Repair Procedure (continued)

11. Measure the propeller shaft to pinion joint angle (J/A).

**NOTE**

ALL measurements MUST be taken from the passenger side of vehicle facing the driver side. Refer to Figure 9 to ensure that the angles measured have the correct positive (+) or negative (-) values assigned.

- An arrow pointing up indicates a positive (+) angle. In the example on the left, the angle measured is a positive 1.15 (+1.15).
- An arrow pointing down indicates a negative (-) angle. In the example on the right, the angle measured is a negative 0.95 (-0.95).

Figure 9.

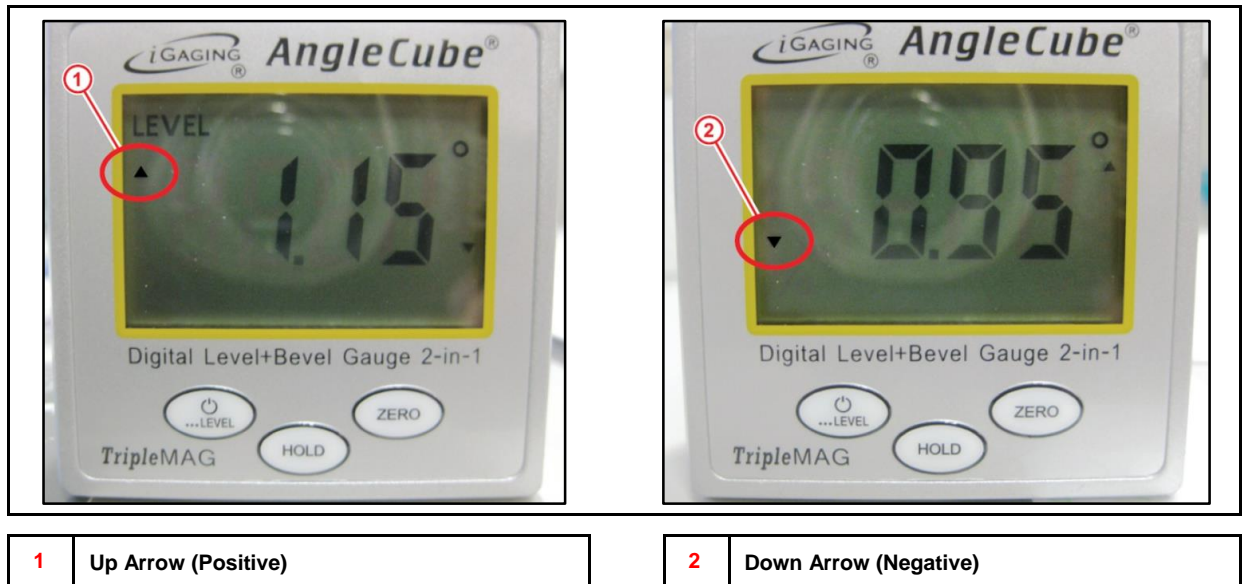

12. Measure the propeller shaft angle (P/A).

- A. Position the flange to the match the orientation shown in Figure 10.

Figure 10.

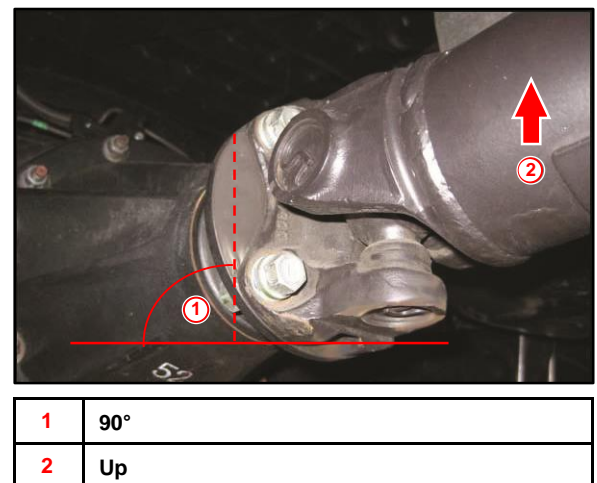

## Driveline Vibration Under Deceleration Around 30 - 10 mph

### Repair Procedure (continued)

- B. Use the digital angle gauge and measure the angle of the rear section of the two-piece propeller shaft.

Ensure the digital angle gauge is placed along the centerline of the propeller shaft as shown in Figure 11.

**Figure 11. CORRECT Placement of Digital Angle Gauge**



**Figure 12. INCORRECT Placement of Digital Angle Gauge**



**NOTE**

The gauge face needs to face the passenger side.

**Figure 13.**

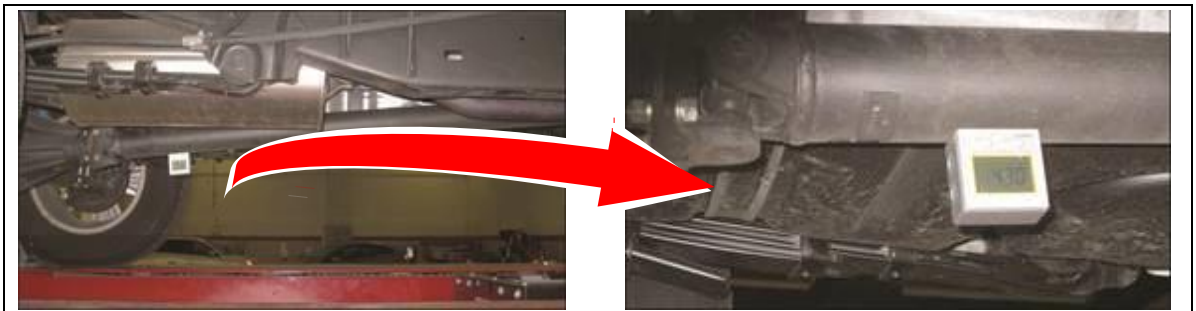

## Driveline Vibration Under Deceleration Around 30 - 10 mph

### Repair Procedure (continued)

C. Record the propeller shaft angle (P/A).

**Table 1. Joint Angle Worksheet (Pinion Flange Angle Minus Propeller Shaft Angle = Joint Angle)**

<b>PINION FLANGE ANGLE</b>	<b>-</b>	<b>PROPELLER SHAFT ANGLE</b>	<b>=</b>	<b>JOINT ANGLE</b>
F/A	-	P/A	=	J/A

**NOTE**

Joint angle (J/A) can be a negative (-) value.

13. Verify if the vehicle is equipped with standard or firm ride suspension.

Look up the factory option codes (accessories) in vehicle history on TIS.

Does the vehicle have option codes **CW, OF, OC, PT, or PY**?

- **YES** — The vehicle has firm ride suspension.
- **NO** — The vehicle has standard suspension.

14. Record the model code for use in the next step.

The model code can be found on the Vehicle Identification Label in the driver doorjamb as shown in Figure 14.

**Figure 14.**

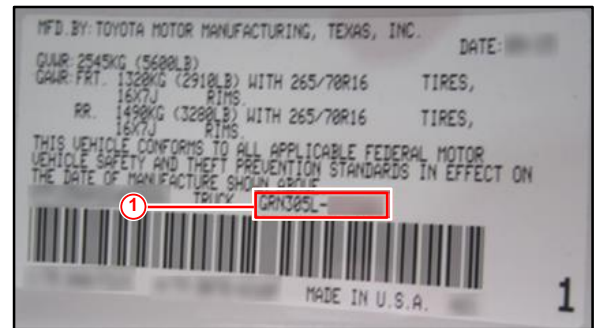

<b>1</b>	<b>Model Code</b>
----------	-------------------

## Driveline Vibration Under Deceleration Around 30 - 10 mph

---

### Repair Procedure (continued)

- After the joint angle, spring type, and model code have been recorded, refer to the table below to determine if the joint angle is in specification.

**Table 2.**

MODEL CODE	CAB TYPE	GRADE	TYPE	JOINT ANGLE RANGE SPECIFICATION
GRN305L-PRTLHA	Double	Limited	Firm	+1.41° to +3.41°
			Standard	+1.38° to +3.38°
GRN305L-PRTSHA		Any	Firm	+1.41° to +3.41°
			Standard	+1.38° to +3.38°
GRN305L-CRTSHA	Access	Any, Excluding Off-Road Package	Firm	+1.7° to +3.7°
		Off Road Package	Standard	-0.6° to +1.4°
		Any, Excluding Off-Road Package		+1.67° to +3.67°

Is the joint angle in specification?

- YES** — Continue to step 16.
- NO** — Go to step 17.

- Test-drive the vehicle between 10 – 30 mph and confirm the level of vibration has improved under deceleration or acceleration.

Did the vibration condition improve?

- YES** — STOP! The applicable repair steps have been completed.
- NO** — This bulletin does NOT apply. Continue diagnosis using the applicable Repair Manual.

## Driveline Vibration Under Deceleration Around 30 - 10 mph

### Repair Procedure (continued)

17. Replace the leaf spring using the part information in the following table:

**Table 3.**

MODEL CODE	CAB TYPE	GRADE	LH PART NUMBER	RH PART NUMBER
GRN305L-PRTLHA	Double	Limited	48220-04480	48210-04840
GRN305L-PRTSHA		Any		
GRN305L-CRTSHA	Access	Any, Excluding Off-Road Package	48220-04470	48210-04830
		Off-Road Package		
		Any, Excluding Off-Road Package		

**NOTE**

When tightening the U-bolt nuts, make sure to set to the following torque:

**Torque: 60 N\*m (610 kgf\*cm, 44 ft\*lbf)**

Refer to TIS, applicable model and model year Repair Manual:

- 2016 – 2019 Tacoma:  
*Suspension – Rear Suspension – “Suspension: Rear Leaf Spring: [Removal / Installation](#)”*
- 2020 - 2021 Tacoma:  
*Suspension – Rear Suspension – “Suspension: Rear Leaf Spring: [Removal / Installation](#)”*

**Figure 15.**

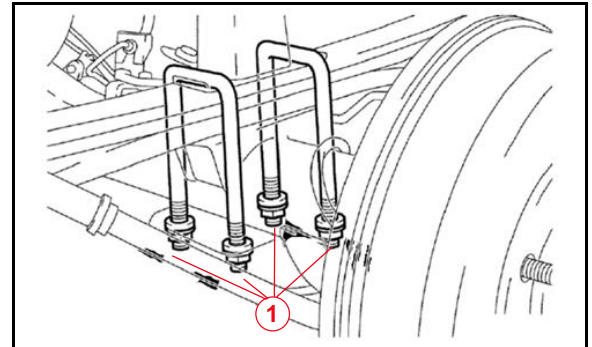

**1 U-bolt Nuts**

**NOTE**

Per the repair manual, fasteners for shocks and leaf spring bushings should be pre-tightened while the vehicle is lifted. Final torque should be set while the vehicle is on the ground.

18. Test-drive the vehicle and confirm that the level of vibration has improved under deceleration between 30 – 10 mph.