



**IMPORTANT SERVICE  
INFORMATION FOR:**

- ✓ SERVICE MANAGER
- ✓ SERVICE ADVISOR
- ✓ TECHNICIAN
- ✓ PARTS DEPARTMENT
- ✓ WARRANTY PERSONNEL

BULLETIN NUMBER:  
**SB18-C-001D**

ISSUE DATE:  
**DECEMBER 2020**

GROUP:  
**GLASS AND INTERIOR**

## **DOOR WIND NOISE/WATER INTRUSION – IMPROVED DOOR SEAL AND ADJUSTMENT PROCEDURE**

### **AFFECTED VEHICLES**

- 2011MY - Current Isuzu N-Diesel
- 2011MY - Current Isuzu N-Gas
- 2018MY - Current Isuzu FTR

***This bulletin is being revised to provide VIN breakpoint information and updated vehicle applications. This bulletin supersedes bulletin SB18-C-001C. Please discard bulletin SB18-C-001C.***

### **INFORMATION**

#### **CONDITION**

Some customers may complain about wind noise and/or water intrusion into the cab from the driver and/or passenger doors of the affected N-Series and FTR trucks.

To correct this condition Isuzu Commercial Truck of America, Inc. (ICTA) is offering a new door weather strip to improve sealing of the driver and passenger doors.

#### **IMPORTANT**

Trucks built after the production dates shown in Table 1 may need the CAB-side seal installed and door adjusted, but will **not** need the DOOR-side seal and door adjustment.

Trucks built before the production dates shown in Table 1 may need both the DOOR-side and CAB-side seals installed with door adjustment.

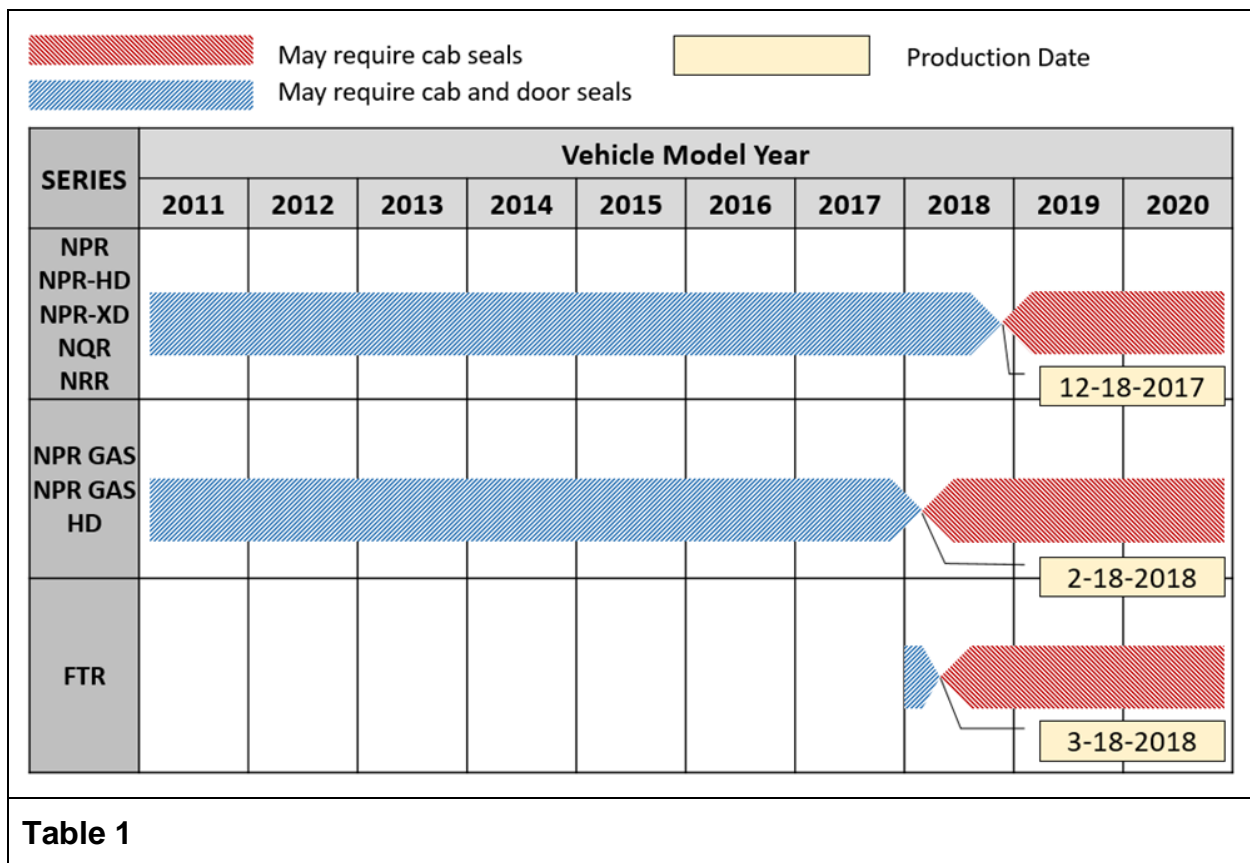

**Table 1**

### VEHICLES INVOLVED

NO cab seal replacement will be necessary on truck models built **after** the VIN breakpoints described in Table 2.

Model	Cable Style	Model Year	VIN Breakpoint
FTR	Tilt	2021	54DK6S163MSG50004
NPR - Gas	Tilt	2020	54DB4W1B5LS806209
NPR - Gas	Crew Cab	2020	54DC4J1B7LS806476
NPR-Diesel	Tilt	2021	JALC4W169M7005989
NPR-Diesel	Crew Cab	2021	JALCDJ163M7006008
NPR-XD	Tilt	2021	JALC4W160M7K00993
NPR-XD	Crew Cab	2021	JALCDJ162M7K00979
NQR	Tilt	2021	JALEEW16XM7900848
NQR	Crew Cab	2021	JALE5J162M7900829
NRR	Crew Cab	2021	JALE5J160M7301704
NRR	Tilt	2021	JALE5W16XM7301738

**Table 2**

**NOTE: On crew cab vehicles, only the front doors are affected by this bulletin.**

**SERVICE PROCEDURE**

**DOOR ALIGNMENT INSPECTION**

1. Measure the offset and gap of the doors at the locations shown in Figure 1. Specifications are shown in Table 3. Measurements are made using two metric rulers as shown in Figures 2, 3 & 4.

<b>TABLE 3</b>				
<b>Door Surface Offset &amp; Gap Specifications</b>				
Location	Offset		Gap	
F	- 3.3mm	+/- 1.5mm	5.1mm	+/- 1.5mm
K	0.0mm	+/- 1.5mm	5.1mm	+/- 1.5mm
S	0.0mm	+/- 1.5mm	5.2mm	+/- 1.5mm

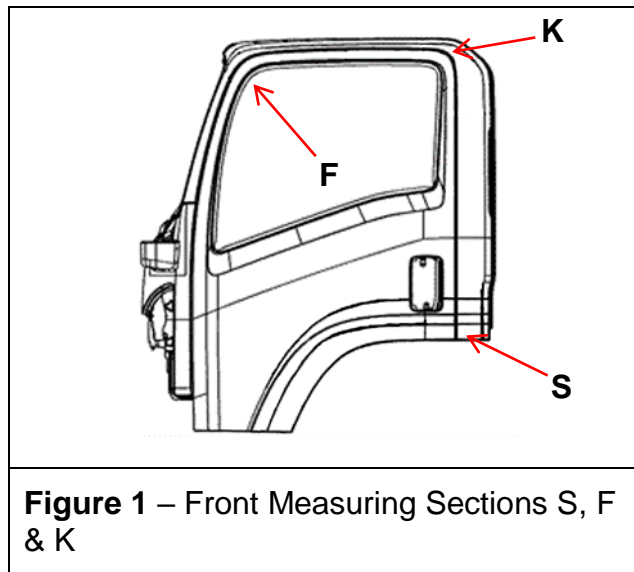



**Figure 2** –Top front corner of door

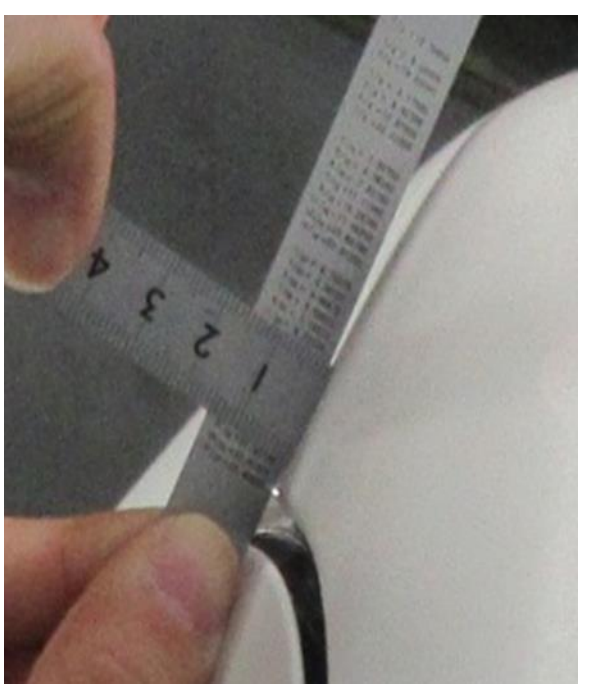

**Figure 3** – Top rear corner of door

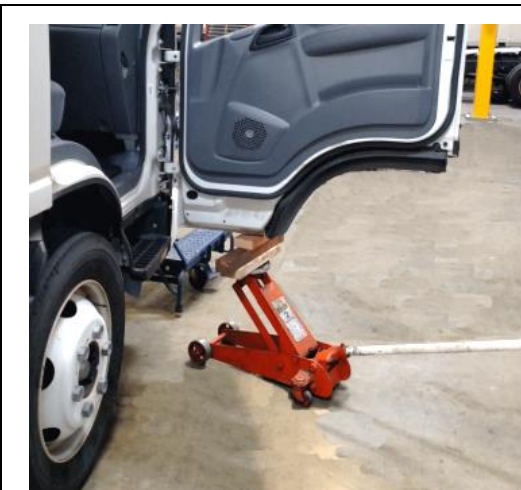

**Figure 4** – Lower rear of door

2. Close the door to ensure there is no binding and that the door closes correctly.
  - If the door's offset is in alignment and is not binding, skip to Cab Weatherstrip Inspection, Step 10.
  - If the door's offset is not aligned or binds and adjustment is necessary, proceed to Door Adjustment, Step 3.

### **DOOR ADJUSTMENT**

3. Open and support the door with a piece of wood using a floor jack. (See Figure 5.)
4. Using a grease pencil make an alignment mark for reference on the door hinge and front door panel. (See Figure 6.)



**Figure 5**

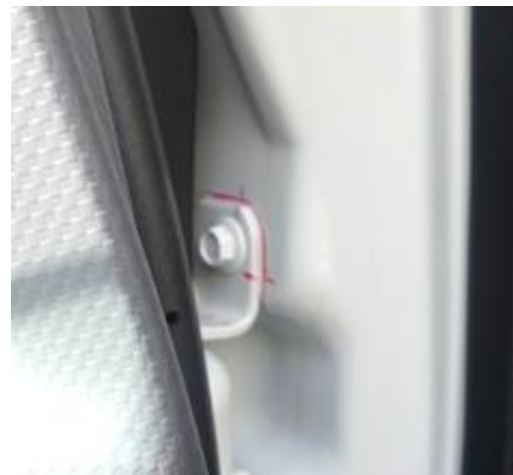

**Figure 6**

5. Loosen bolt Number 1 shown in Figure 7 using a 3/8" drive ratchet, a 1" long-3/8" drive extension, and a 12mm crow's foot. After the bolt is loose, remove the bolt using a 12mm wrench. Replace bolt Number 1 with a new bolt, the part number for which is provided on the last page of this bulletin.

**IMPORTANT: DO NOT TORQUE BOLTS UNTIL AFTER DOOR ALIGNMENT IS COMPLETED.**

6. Install the new bolt by hand tightening, and then secure the bolt with the same tools used to remove it earlier.

**NOTE: The bolts should be loose enough that the door/hinge can be adjusted but still tight enough that the assembly does not move freely.**

7. Repeat Steps 5 and 6 for bolts 2, 3, and 4. (See Figure 7.)

**NOTE: The gap between the top of the door and the cabin should be adjusted with the window down to prevent glass breakage.**

8. Adjust the doors.
  - a. If the door protrudes from the body or is recessed into the bodylines, adjust the door where the door hinge bolts to the door, as marked and shown by the red arrows in Figure 8.
    - Red arrows – moving the door away from the interior will raise the door from the cab when the door is closed.
  - b. If the door is not centered in the doorframe, adjust the door where the door hinge bolts to the cab, as marked and shown by the blue arrows in Figure 8.
    - Blue arrows – move the door in the direction needed to center the door in the doorframe.
9. When the doors have been adjusted correctly, torque all the new door bolts to the specified torque using a 3/8" drive torque wrench, a 1" long-3/8" drive extension, and a 12mm crow's foot. Tightening Torque - 21.6 N•m (15.9 lb•ft)

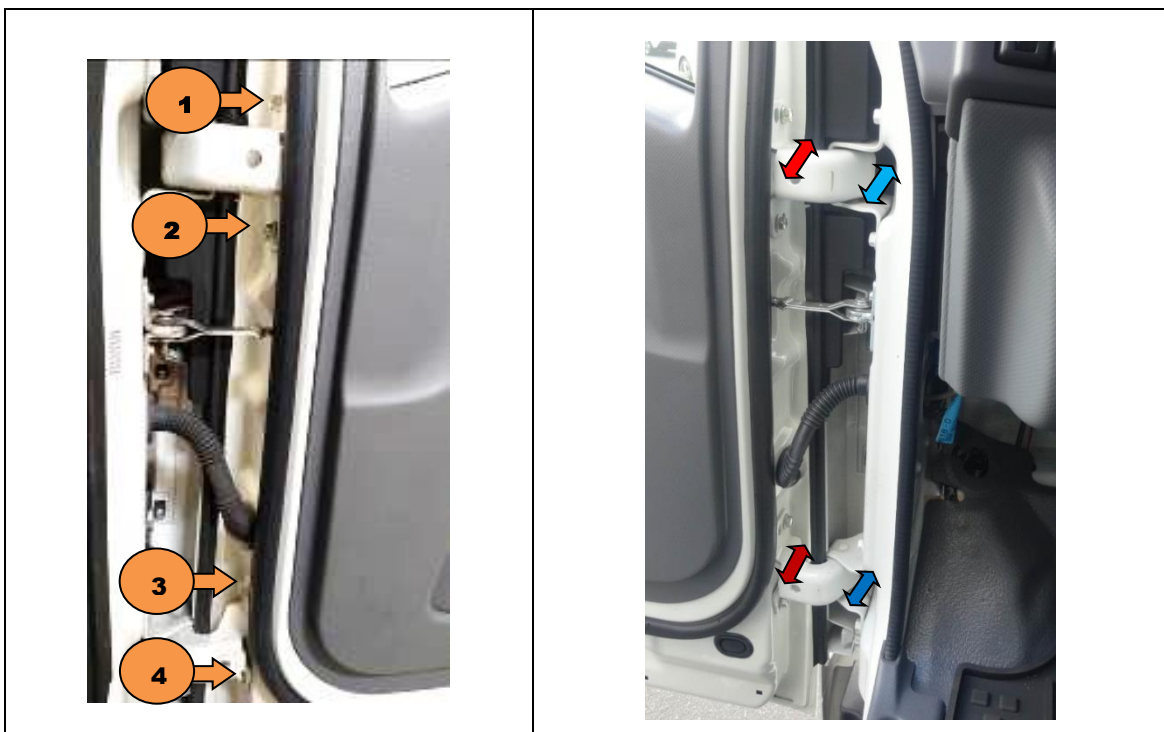
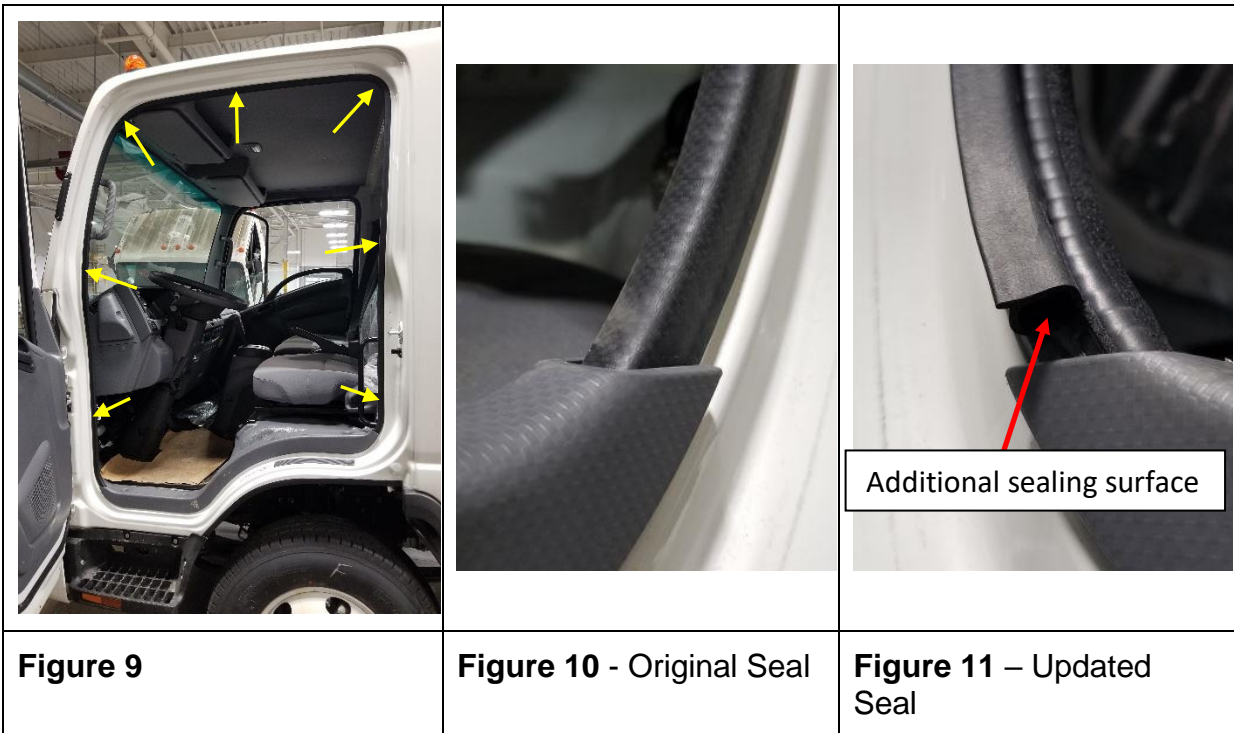

**Figure 7**

**Figure 8 - View from inside driver's door.**

### CAB WEATHERSTRIP INSPECTION

10. On single cab, N-Series vehicles check the seal on the **cab-side** of the door opening (See Figure 9) to determine if it is an original seal design or a previously offered revision. (See Figures 10 & 11.)
  - a. If the original seals are present as shown in Figure 10, replace them with the redesigned **cab seal** and continue to Step 11.
  - b. If the seals on the vehicle's **cab** are as those shown in Figure 11, skip to Step 24.
  - c. If vehicle is an FTR, continue to Step 11.



### CAB WEATHERSTRIP REMOVAL & INSTALLATION

11. Remove the passenger door sill protector by removing four (4) screws. (See Figure 12.)
12. Remove the old weather strip by pulling weather strip away from the cabin pinch weld surface. (See Figure 13.)

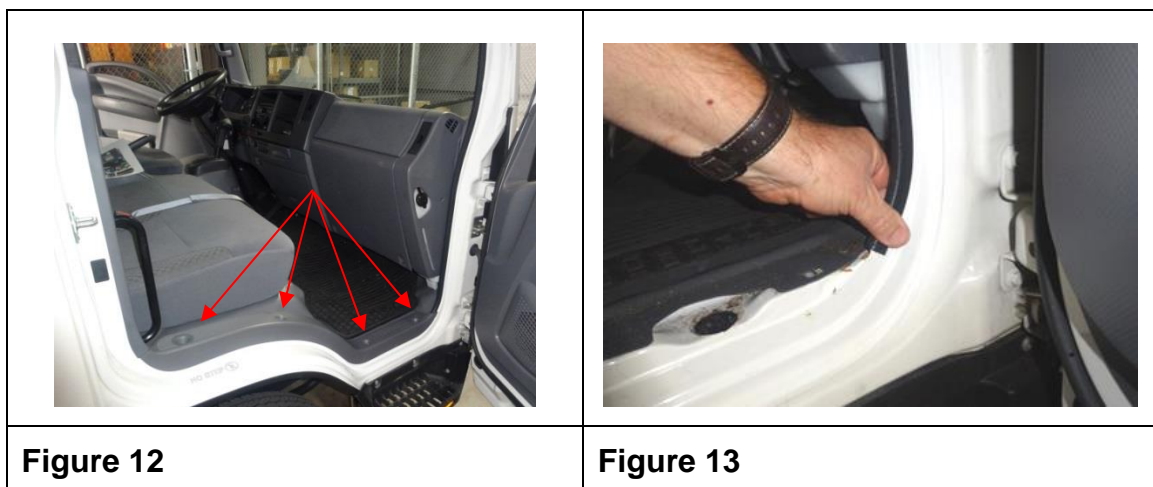

13. Wipe down the pinch weld surface using a clean cloth. (See yellow arrows in Figure 14.)

**CAUTION: BE CAREFUL OF SHARP EDGES.**

14. Attach the new weather strip to the pinch welding surface, starting at the rear quarter side, marked by the red arrow in Figure 14, and work towards the front.

15. Using a rubber mallet, ensure the weather strip is fully seated. (See Figure 15.)

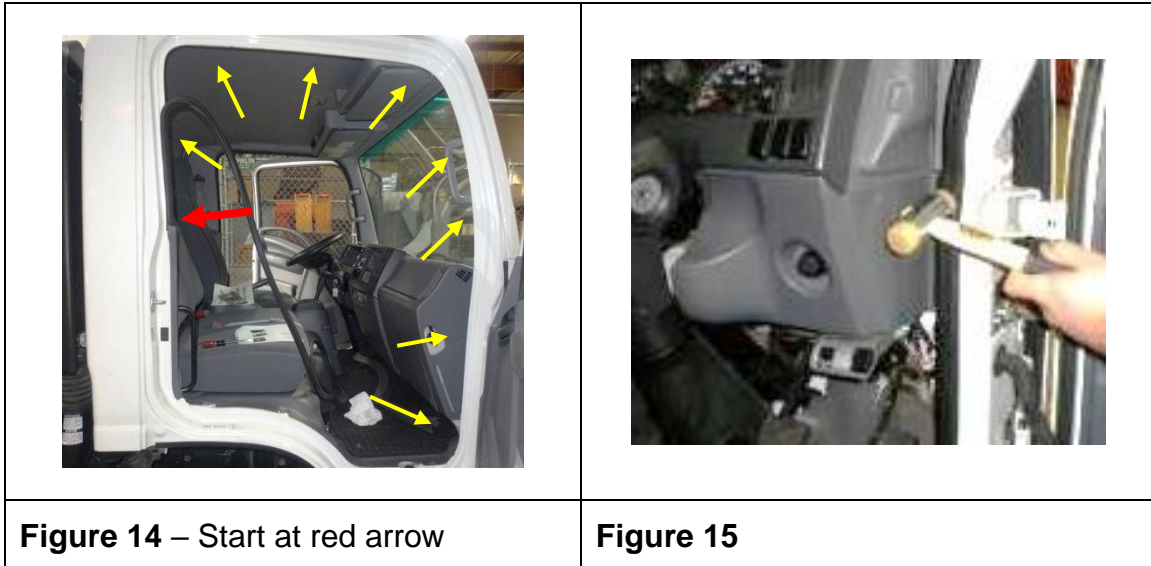

16. Install the door sill protector. (Refer back to Figure 12.)

- If the new seal interferes with and sits below the door side sill protector, as shown in Figure 16 below, proceed to Step 17.
- If there is no interference, repeat on other side.
- If both doors have been completed, skip to Step 24.

**NOTE: Weather strip should fit into the door sill protector without interference.** (See Figure 19.)

#### **IF WEATHER STRIP INTERFERES WITH DOOR SILL PROTECTOR**

17. Using a pen, mark the seal using the top of the door side sill protector as a guide to where the weather strip needs to be cut. (See Figure 16.)

**NOTE: Weather strip is removed from vehicle in the photo below for illustrative purposes only. Procedure can be done with weather strip remaining on the vehicle.** (See Figure 17.)

18. Remove both sill plate and lower part of weather strip to be cut from cab

19. Using sharp scissors, cut both sides of the weather strip at the attachment points up to where the pen mark is shown in Figure 17.



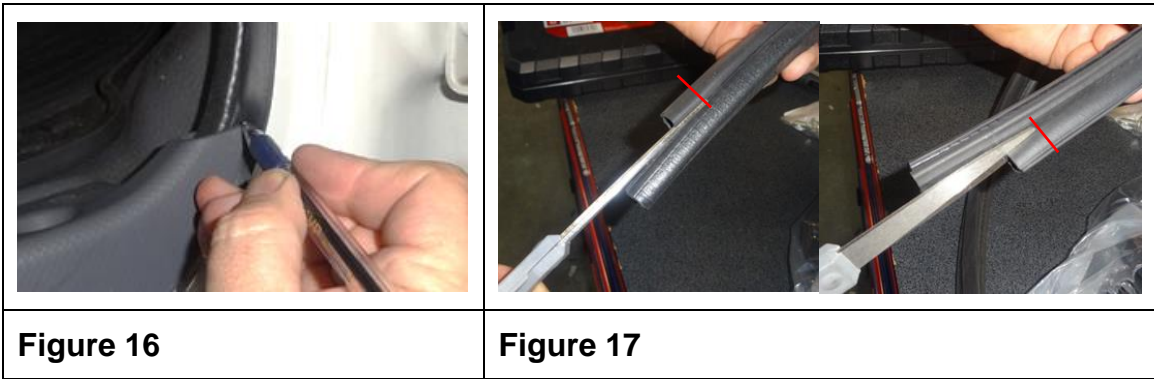

20. Cut off the piece of the seal that is interfering with the door sill protector. (See Figure 18.)

**NOTE: Weather strip should fit into the door sill protector without interference.** (See Figure 19.)

21. Reinstall weatherstrip onto cab pinch weld using mallet to seat. (See Figure 15.)

22. Reinstall door sill protector.

23. Repeat procedure for other side of vehicle, as necessary.

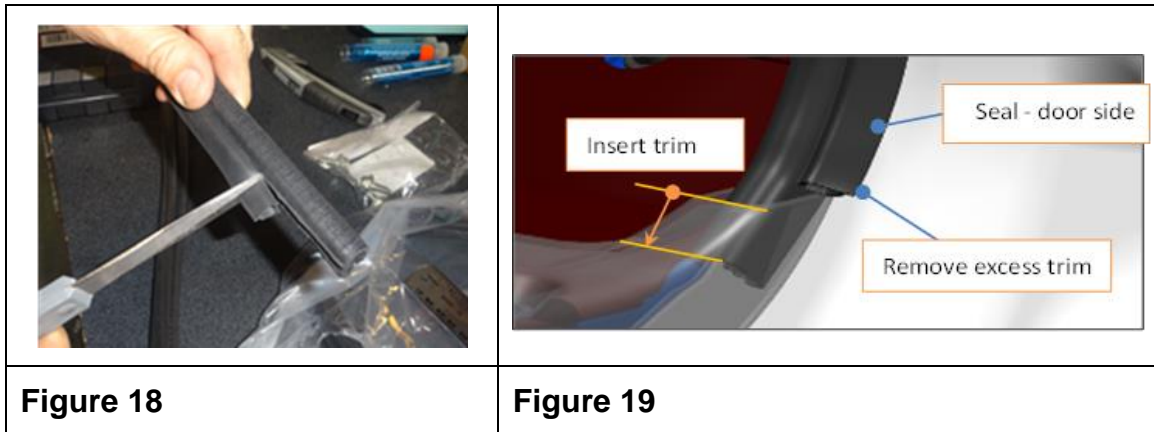

## DOOR WEATHERSTRIP INSPECTION

24. On single cab, N-Series vehicles check the seal on the **door side** of the door opening (See Figure 20) to determine if it is an original seal design or a previously offered revision.

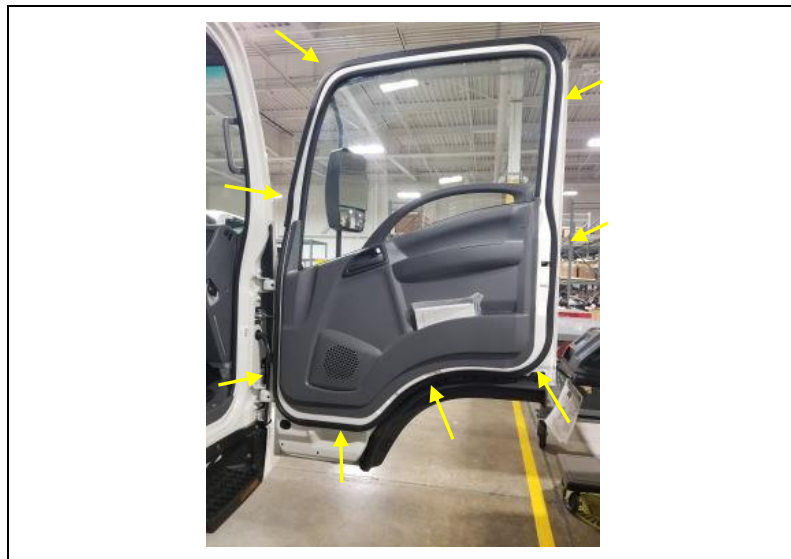

**Figure 20**

- a. If the original seals are present as shown in Figure 20, continue to Step 25.
- b. If the seals on the vehicle's **door** are as those shown in Figures 21 & 22, skip to Step 29.
- c. If vehicle is an FTR, skip to Step 26.

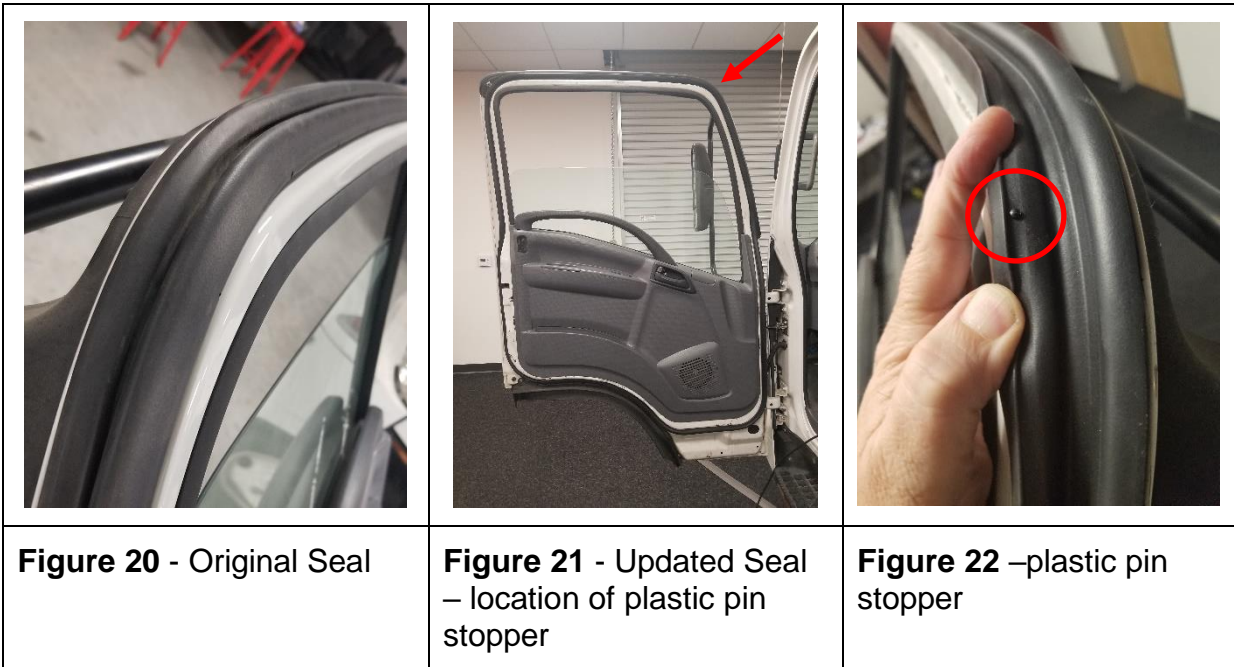

## DOOR WEATHERSTRIP REMOVAL & INSTALLATION

25. Remove the side **door seal** shown in Figure 23 by pulling door seal from the door.
  - Using a trim panel tool or wire cutters remove mounting fasteners from door. (See Figure 24.)

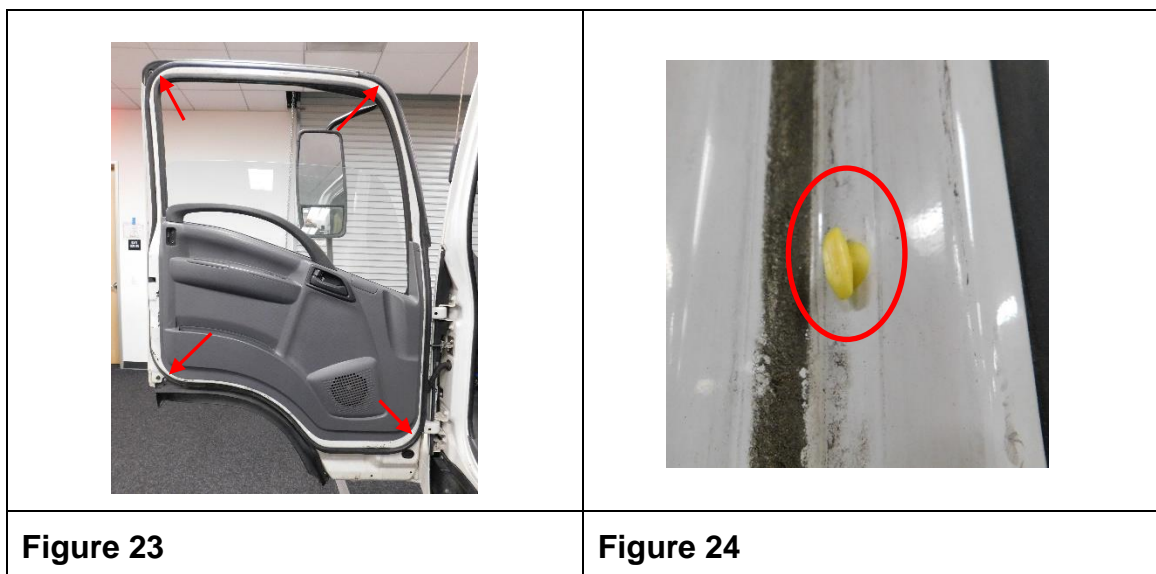

26. Wipe down seal mounting surface using a clean cloth.

27. Attach the new door seal:

- Start at the top, outside corner, as shown by red arrow in Figure 25.
- Fasten the seal, working across the top of the door and then down to the bottom of the door – see yellow arrows in Figure 25.
- Go back to the top corner and connect the seal down the opposing side of the door, working towards the bottom.
- Now fasten the seal across the bottom, as shown by yellow arrows in Figure 26.

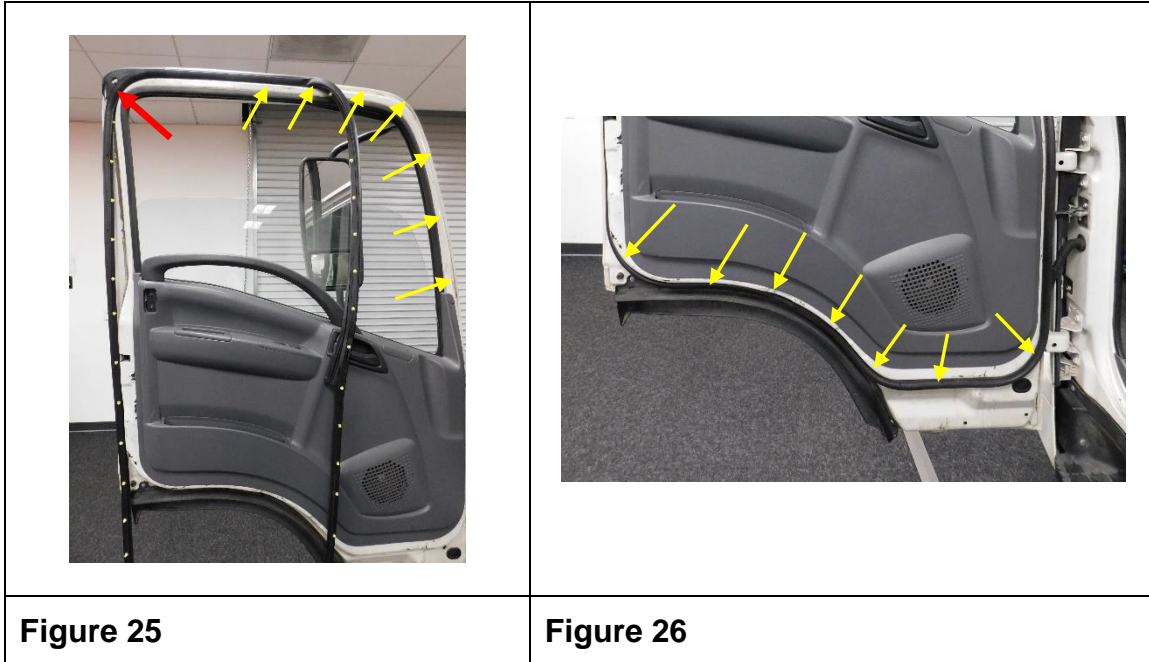

28. Repeat the procedure on the remaining door/s.

### PARTS INFORMATION

The following part numbers are for revised seals and non-shouldered bolts. The non-shouldered bolts will allow slight movement so the door can be adjusted. Parts are to be obtained from AIPDN.

<b>Front Door</b>			
<b>Model</b>	<b>Part Number</b>	<b>Description</b>	<b>Qty</b>
<b>CAB-SIDE WEATHERSTRIP</b>			
N-Single	8-97664-929-0	WEATHERSTRIP; FRONT, RH	1
N-Single	8-97664-930-0	WEATHERSTRIP; FRONT, LH	1
N-Crew	8-97664-931-0	WEATHERSTRIP; FRONT, RH	1
N-Crew	8-97664-932-0	WEATHERSTRIP; FRONT, LH	1
<b>DOOR-SIDE WEATHERSTRIP</b>			
N-Series	8-98484-919-0	WEATHERSTRIP; FRONT, RH	1
N-Series	8-98484-920-0	WEATHERSTRIP; FRONT, LH	1
<b>FTR CAB-SIDE WEATHERSTRIP</b>			
FTR	8-97664-929-0	WEATHERSTRIP;FRT SIDE, RH	1
FTR	8-97664-930-0	WEATHERSTRIP;FRT SIDE, LH	1
<b>FTR DOOR SIDE WEATHERSTRIP</b>			
FTR	8-98484-921-0	WEATHERSTRIP;FRT SIDE, RH	1
FTR	8-98484-920-0	WEATHERSTRIP;FRT SIDE, LH	1
<b>N-SERIES AND FTR</b>			

ALL	8-98049-756-0	HINGE BOLT	16 (4 per hinge, 8 per door, as needed)
-----	---------------	------------	---

## WARRANTY INFORMATION

The following labor operation information is provided for warranty claim submission and applicable to vehicles still covered by the New Vehicle Warranty.

Labor Operation	Description	Labor Time
C1067	WEATHERSTRIP (DOOR SEAL), FRONT DOORS BOTH – REPLACE	0.3
	ADD: REPLACE FRONT DOOR CAB BOTH WEATHERSTRIP	0.6
C1068	WEATHERSTRIP (DOOR SEAL) – FRONT DOORS BOTH – REPLACE AND ADJUST	1.4
	ADD: REPLACE FRONT DOOR CAB WEATHERSTRIP	0.6