



SERVICE BULLETIN

Classification: DA19-016c	Reference: NTB19-064c	Date: February 2, 2021
------------------------------	--------------------------	---------------------------

VOLUNTARY SERVICE CAMPAIGN 2017-2018 ROGUE, ROGUE HYBRID, AND ROGUE SPORT; ICC/ADAS AND LASER/RADAR REPROGRAMMING

This bulletin has been amended. See **AMENDMENT HISTORY** on the last page.
Please discard previous versions of this bulletin.

CAMPAIGN ID #: P9327
APPLIED VEHICLES: 2017-2018 Rogue (T32)
2017-2018 Rogue Hybrid (T32)
2017-2018 Rogue Sport (J11)

**Check Service COMM or Dealer Business Systems (DBS)
National Service History to confirm campaign eligibility.**

INTRODUCTION

Nissan is conducting this voluntary service campaign on certain specific model year 2017-2018 Rogue, Rogue Hybrid, and Rogue Sport vehicles to reprogram the Laser/Radar and/or ICC/ADAS control units. This service will be performed at no charge to the customer for parts or labor.

IDENTIFICATION NUMBER

Nissan has assigned identification number P9327 to this campaign. This number must appear on all communication and documentation of any nature dealing with this campaign.

DEALER RESPONSIBILITY

Dealers are to repair vehicles falling within range of this campaign that enter the service department. This includes vehicles purchased from private parties, vehicles presented by transient (tourists) owners, and vehicles in a dealer's inventory.

Nissan Bulletins are intended for use by qualified technicians, not 'do-it-yourselfers'. Qualified technicians are properly trained individuals who have the equipment, tools, safety instruction, and know-how to do a job properly and safely. HINT: If you believe that a described condition may apply to a particular vehicle, DO NOT assume that it does. See your Nissan dealer to determine if this applies to your vehicle.

REPAIR OVERVIEW

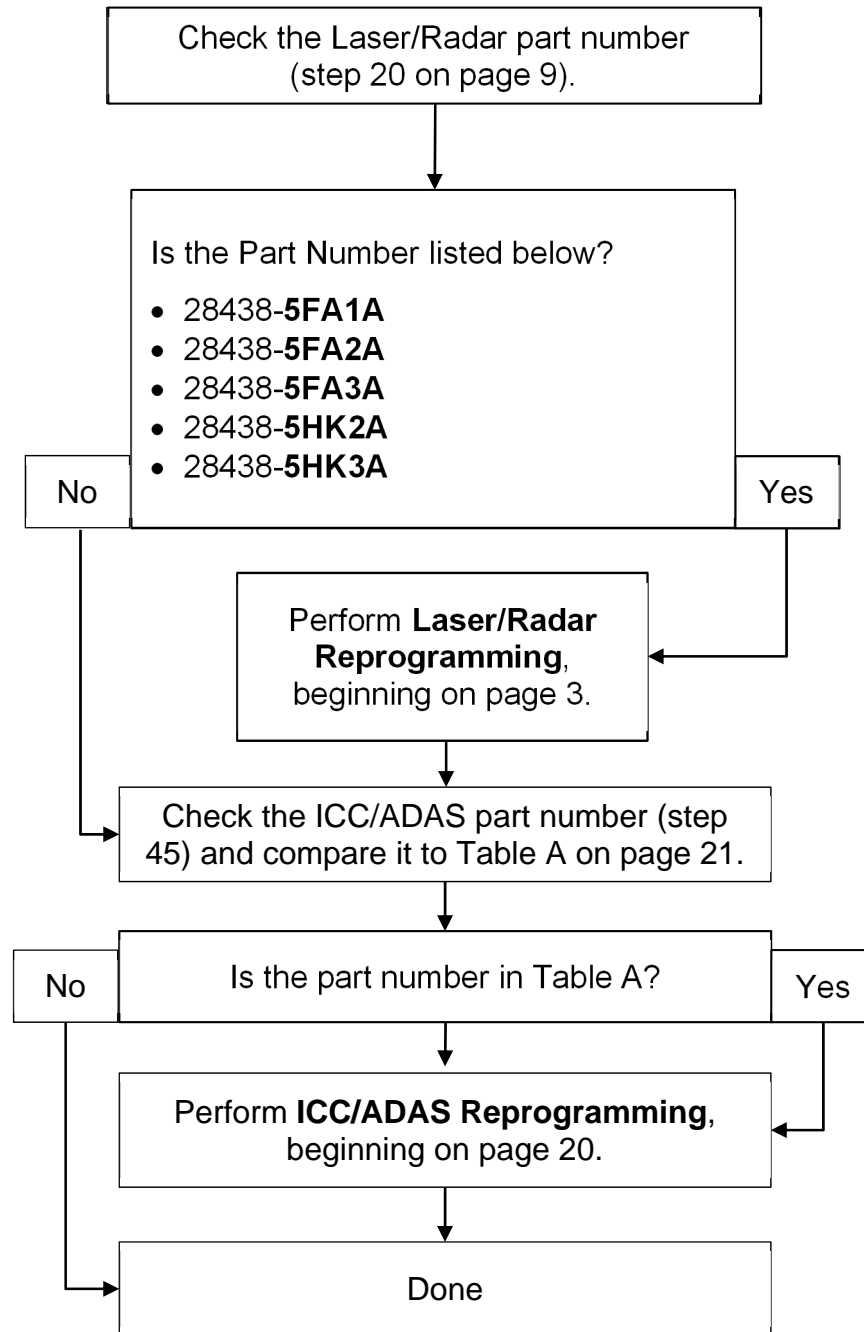

HINT: If reprogramming is not performed, refer to the Electronic Service Manual (ESM) for further diagnostic information.

SERVICE PROCEDURE

Laser/Radar Reprogramming

IMPORTANT: Before starting, make sure:

- ASSIST on the CONSULT PC has been synchronized (updated) to the current date.
- All CONSULT-III plus (C-III plus) software updates (if any) have been installed.
- The CONSULT PC is connected to the Internet via a cable or Wi-Fi.
 - Later in the procedure you will be required to enter your User Name and Password.
 - The CONSULT PC must be connected to the Internet.
 - If you do not know your User Name and Password, contact your Service Manager.
- A screen print for warranty documentation can be done from the CONSULT PC during this process while still connected to the vehicle.
- No Diagnostic Trouble Codes (DTCs) are stored.
 - Use C-III plus to perform Self Diagnosis for all systems.
 - If there are any DTCs: Diagnose, perform repairs, and erase DTCs **before** continuing.

1. Connect the plus Vehicle Interface (plus VI) to the vehicle.

NOTICE

Make sure the plus VI is securely connected. If the plus VI connection is loose during reprogramming, the process will be interrupted and the **control unit may be damaged**.

2. Connect the AC Adapter to the CONSULT PC.

NOTICE

Be sure to connect the AC Adapter. If the CONSULT PC battery voltage drops during reprogramming, the process will be interrupted and the **control unit may be damaged**.

3. Connect a battery maintainer or smart charger set to reflash mode or a similar setting. If the vehicle's battery voltage drops below 12.0V or rises above 15.5V during reprogramming, the Laser/Radar control unit may be damaged.
4. Turn OFF all external Bluetooth® devices (e.g., cell phones, printers, etc.) within range of the CONSULT PC and the VI.

NOTICE

Make sure to turn OFF all external Bluetooth® devices. If Bluetooth® signal waves are within range of the CONSULT PC and the plus VI during reprogramming, reprogramming may be interrupted and the **control unit may be damaged**.

5. Turn the ignition ON with the engine OFF.
 - The engine must not start or run during the reprogramming procedure.
6. Turn OFF all vehicle electrical loads such as exterior lights, interior lights, HVAC, blower, rear defogger, audio, NAVI, seat heater, steering wheel heater, etc.
7. Turn ON the CONSULT PC.
8. Start C-III plus.

9. Wait for the plus VI to be recognized.
 - The serial number will display when the plus VI is recognized.

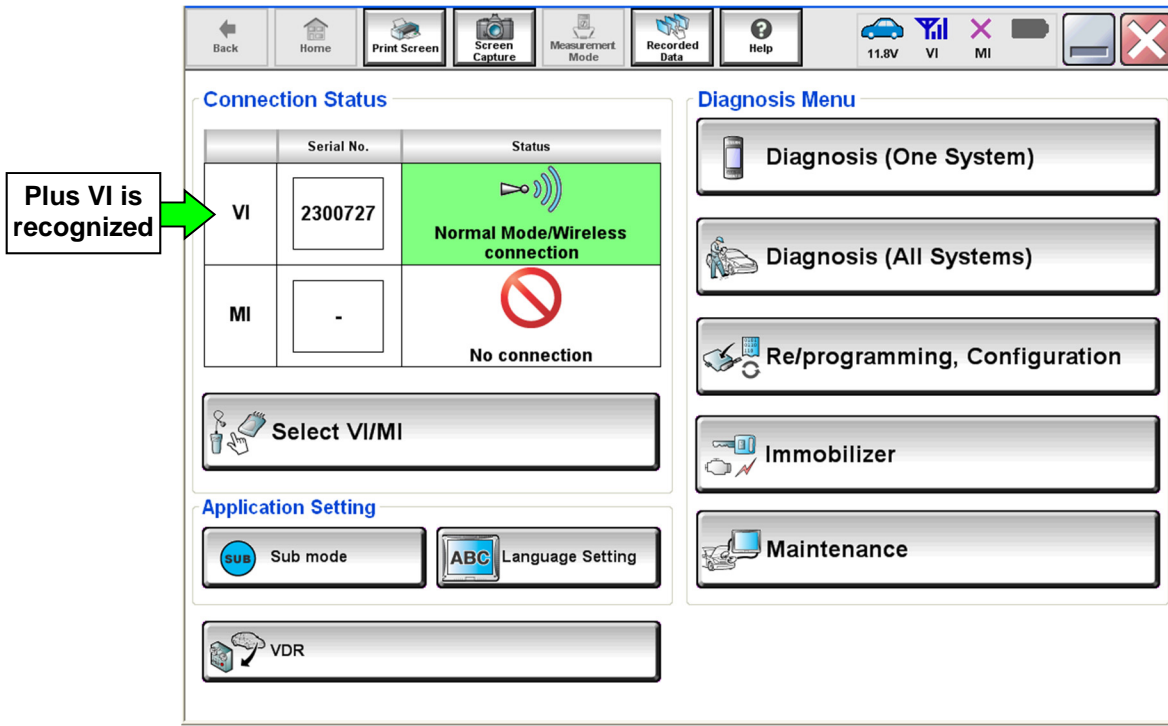

Figure 1

10. Select **Re/programming, Configuration**.

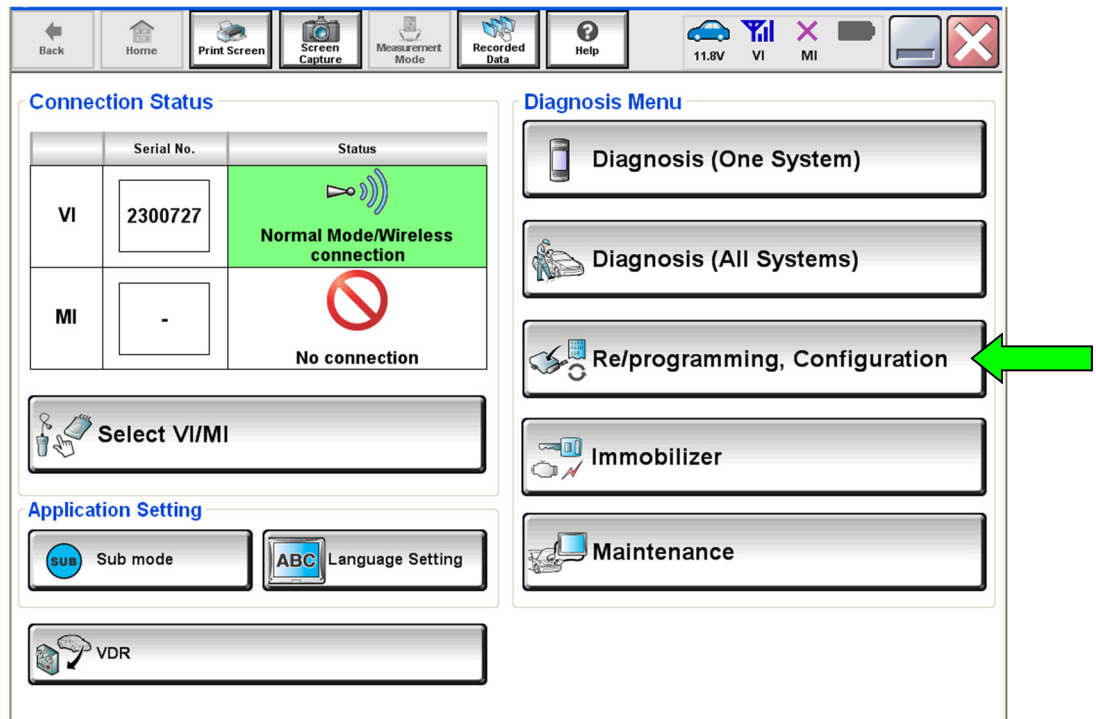

Figure 2

11. Use the arrows (if needed) to view and read all precautions.
12. Check the box confirming the precautions have been read.
13. Select **Next**.

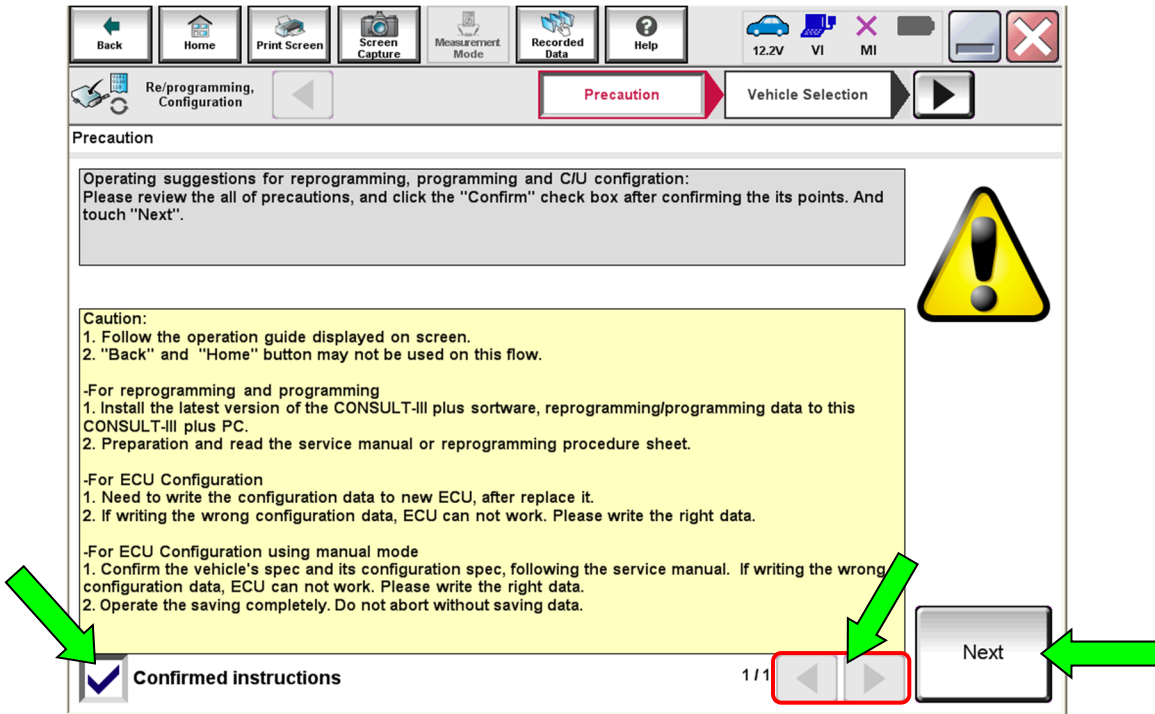

Figure 3

14. Select **Automatic Selection(VIN)**.

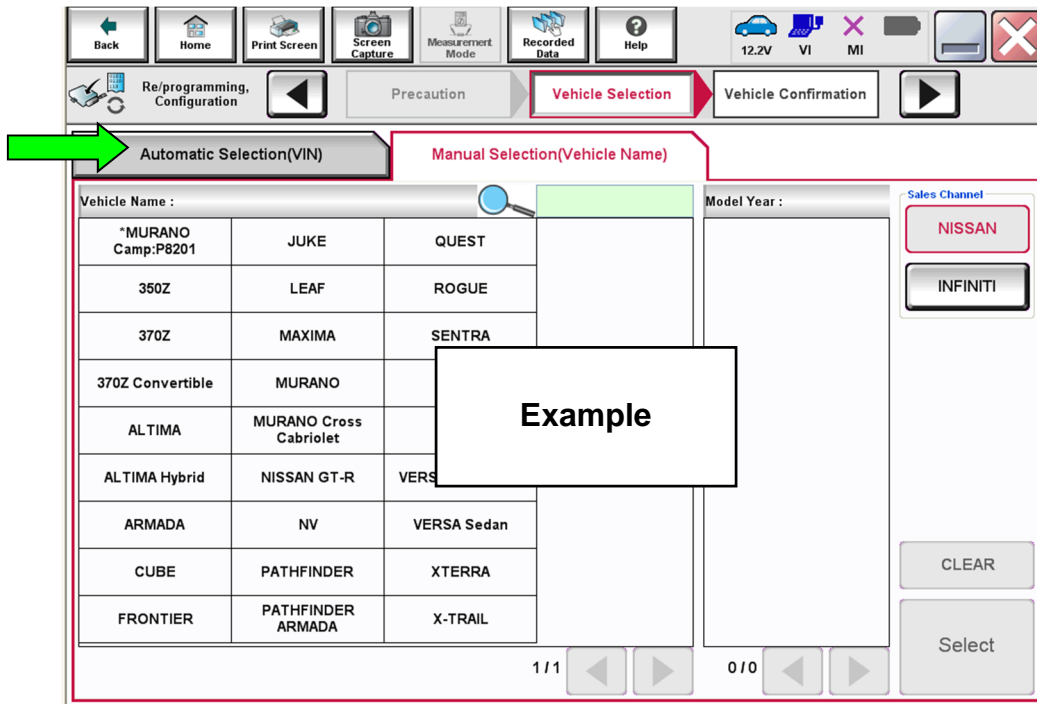

Figure 4

15. Make sure **VIN or Chassis #** matches the vehicle's VIN.
16. If the correct VIN is displayed, select **Confirm**.

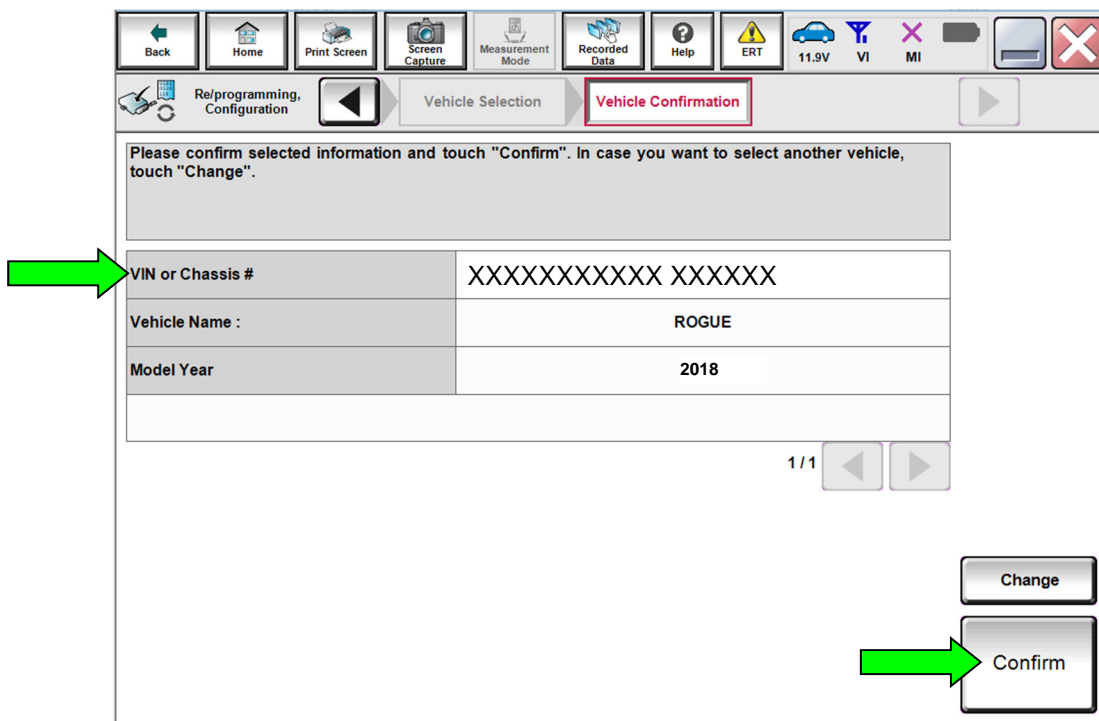

Figure 5

17. Select **Confirm**.

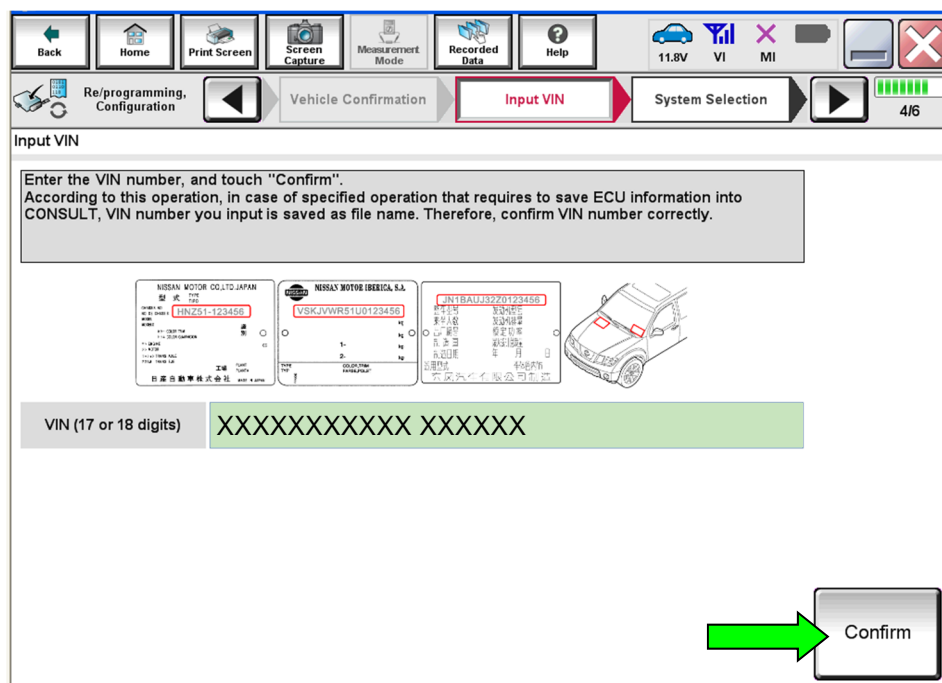

Figure 6

18. Select **LASER/RADAR**.

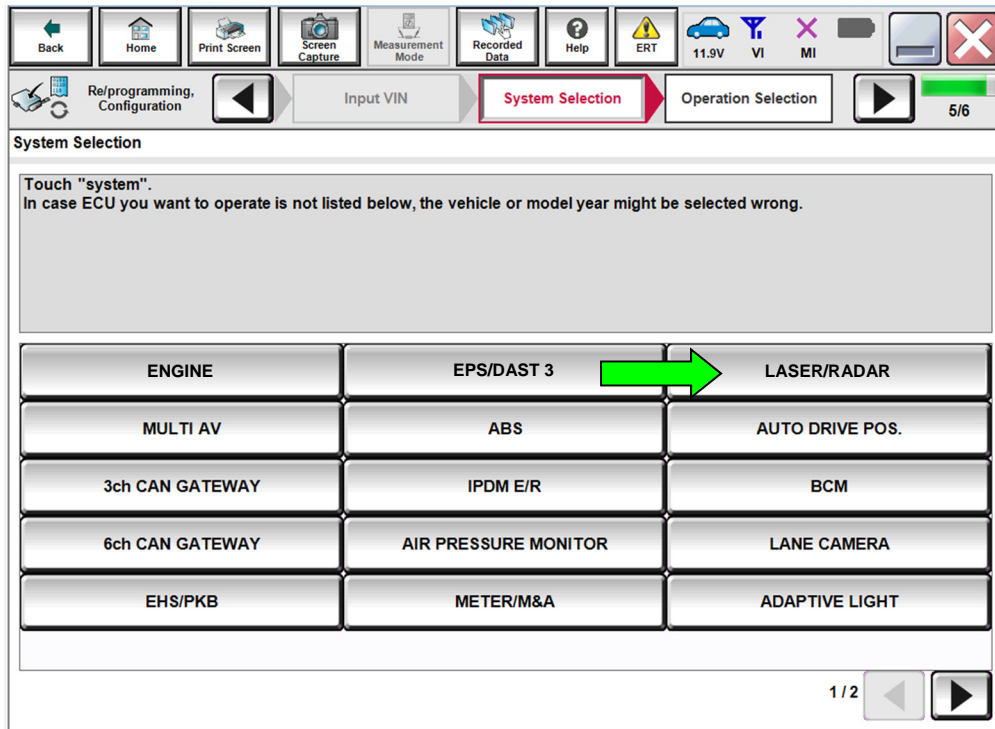

Figure 7

19. Select **Reprogramming**.

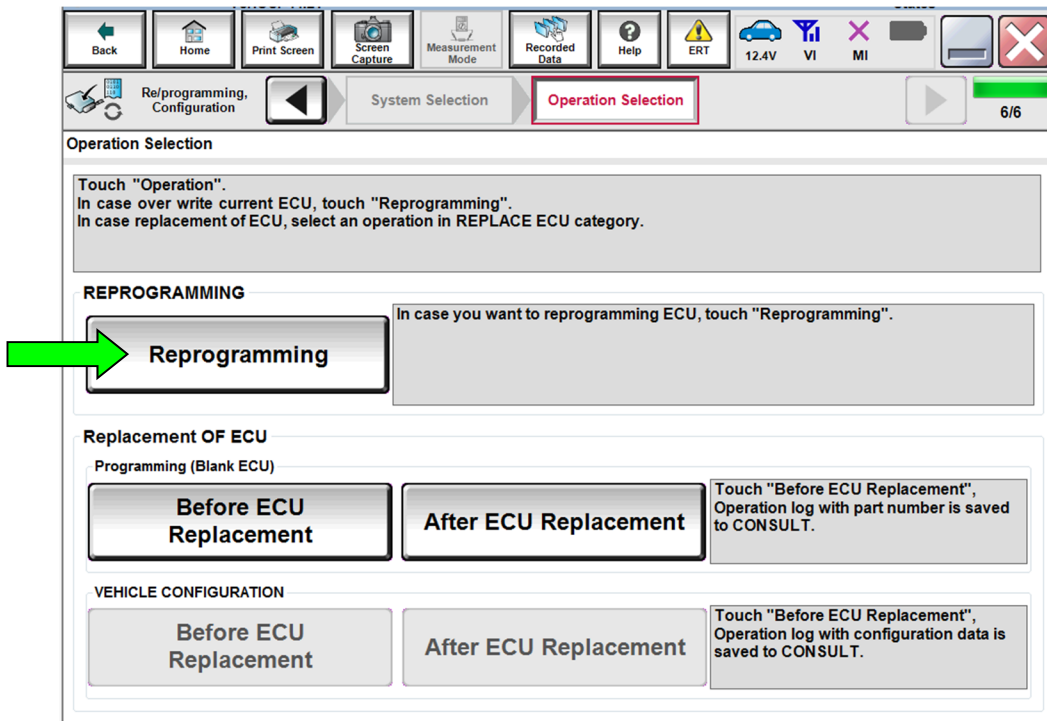

Figure 8

20. When you get to the screen shown in Figure 9, confirm that a reprogram is available with the flow chart below.

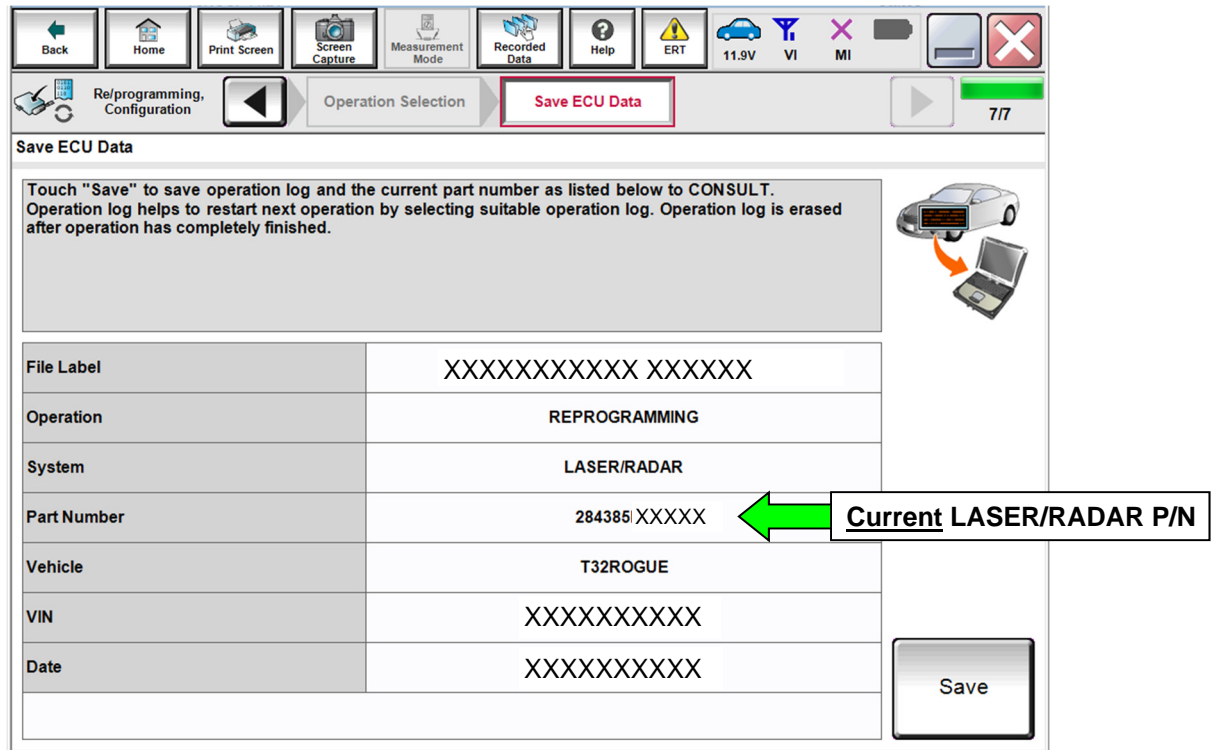
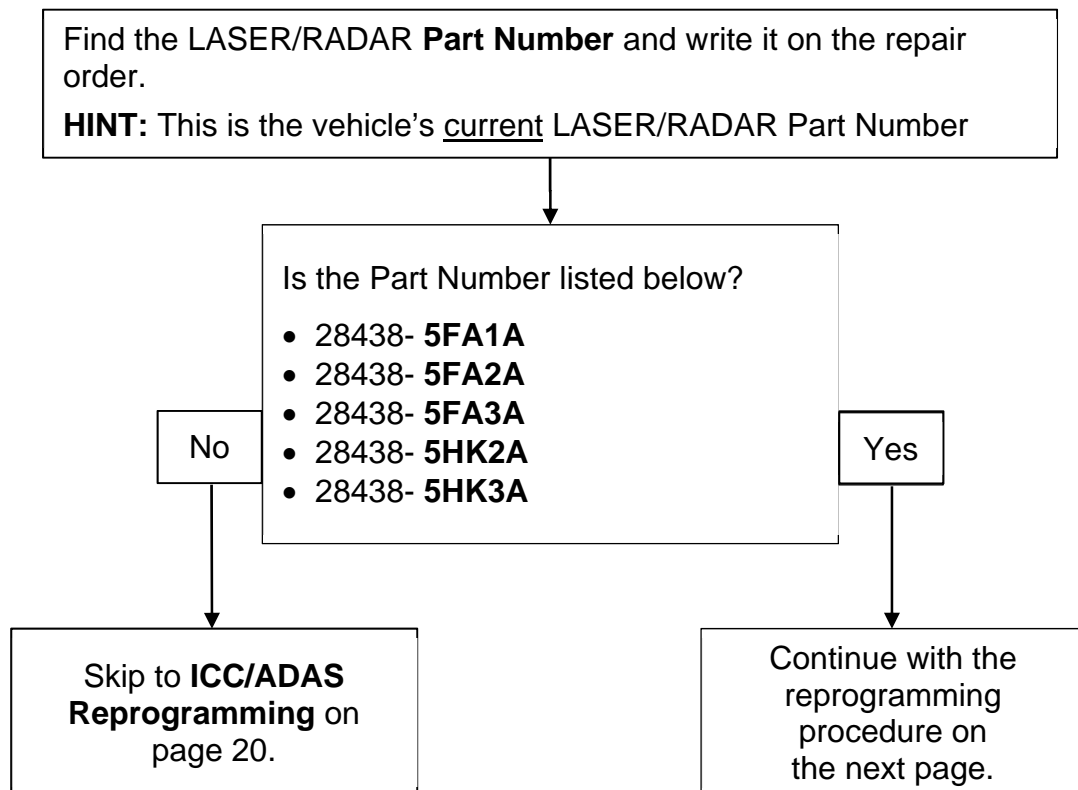

Figure 9



21. Select **Save**.

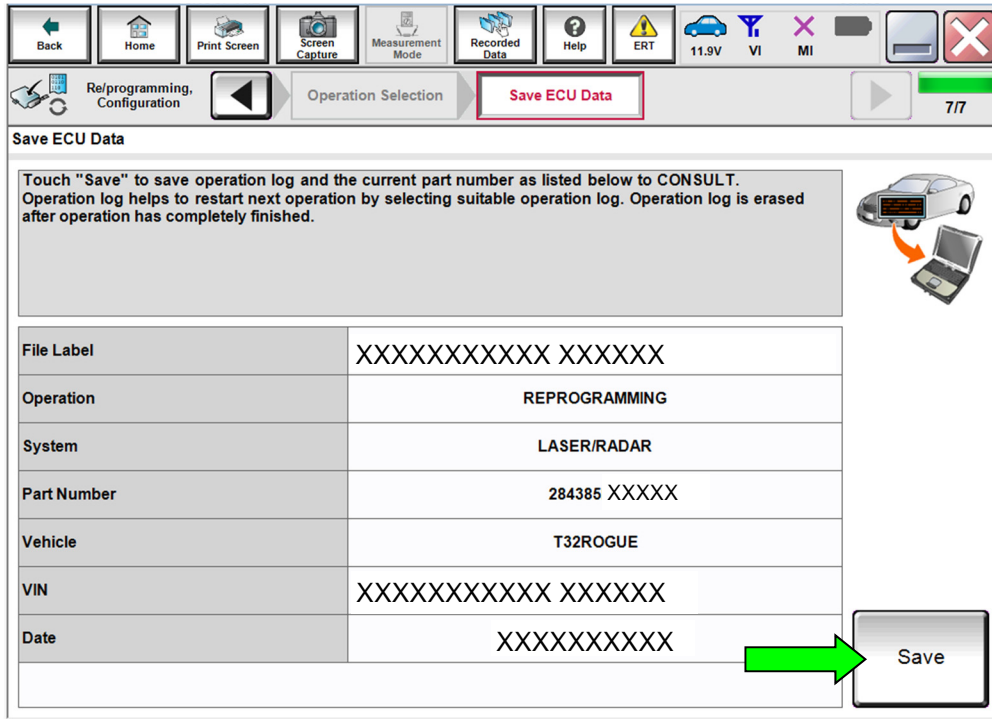

Figure 10

22. Use the arrows (if needed) to view and read all precautions.

23. Check the box confirming the precautions have been read.

24. Select **Next**.

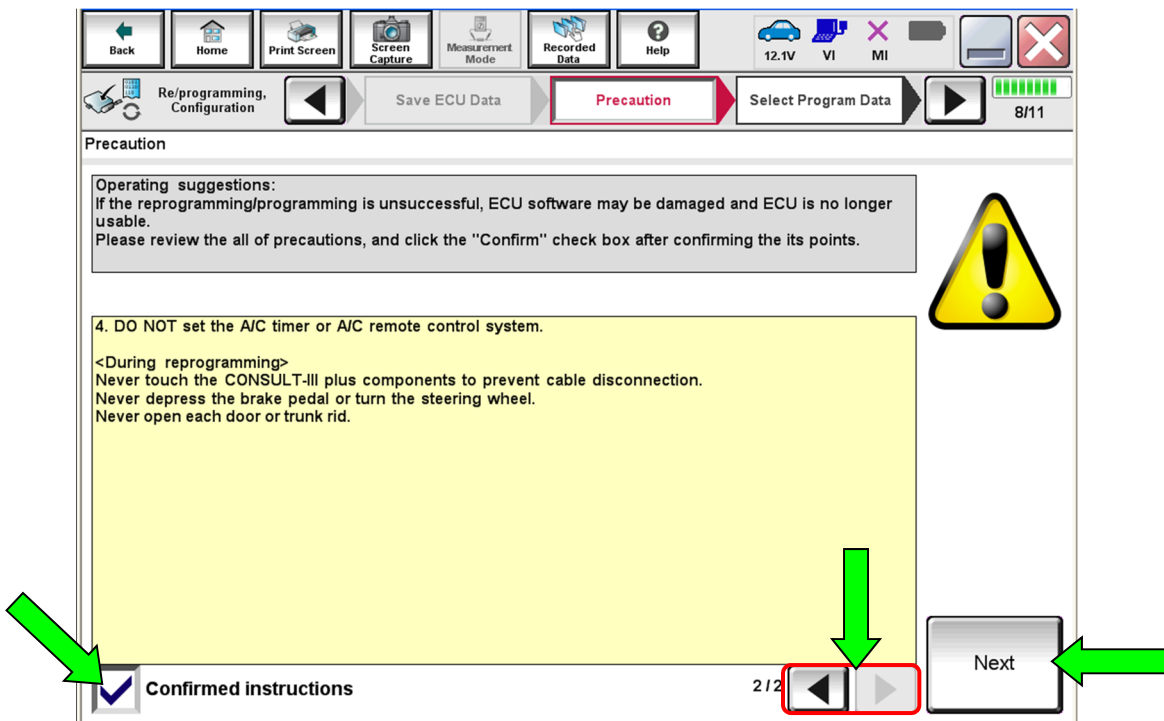

Figure 11

25. Read the **Current Part Number** and **Part Number After Reprogramming**. They should be different.

26. Select **Next**.

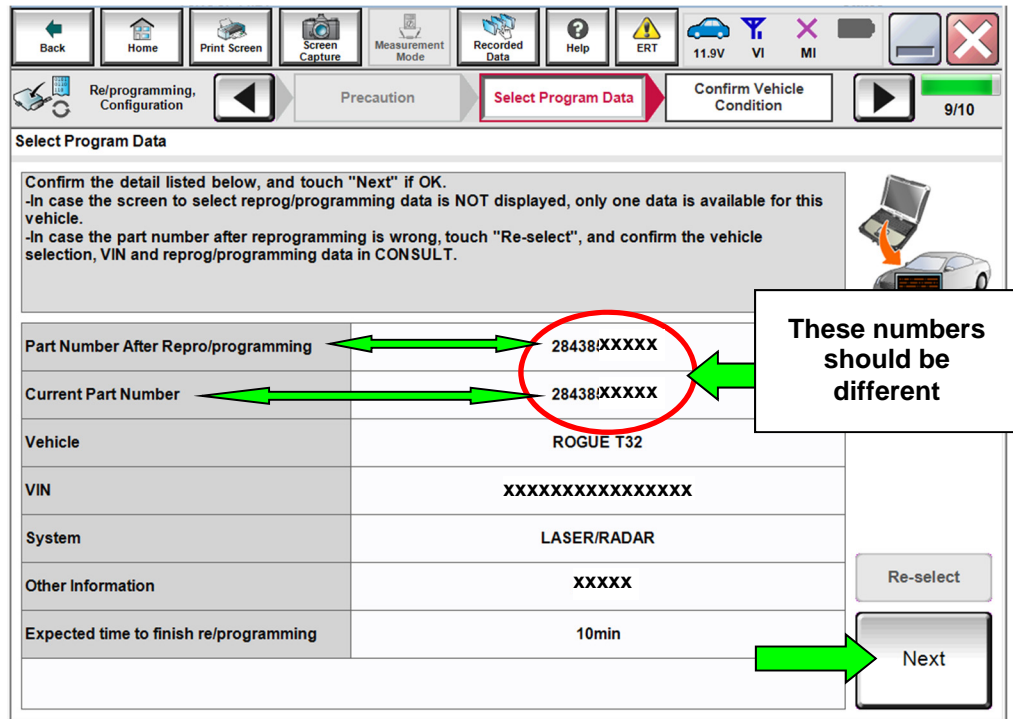

Figure 12

HINT:

- In some cases, more than one new P/N for reprogramming is available.
 - If more than one new P/N is available, the screen in Figure 13 displays.
 - Select and use the reprogramming option that does **not** have the message “Caution! Use ONLY with NTBXX-XXX”.
- If you get this screen and it is blank (no reprogramming listed), it means there is no reprogramming available for the Laser/Radar control unit in this vehicle. Proceed to **ICC/ADAS Reprogramming** on page 20.

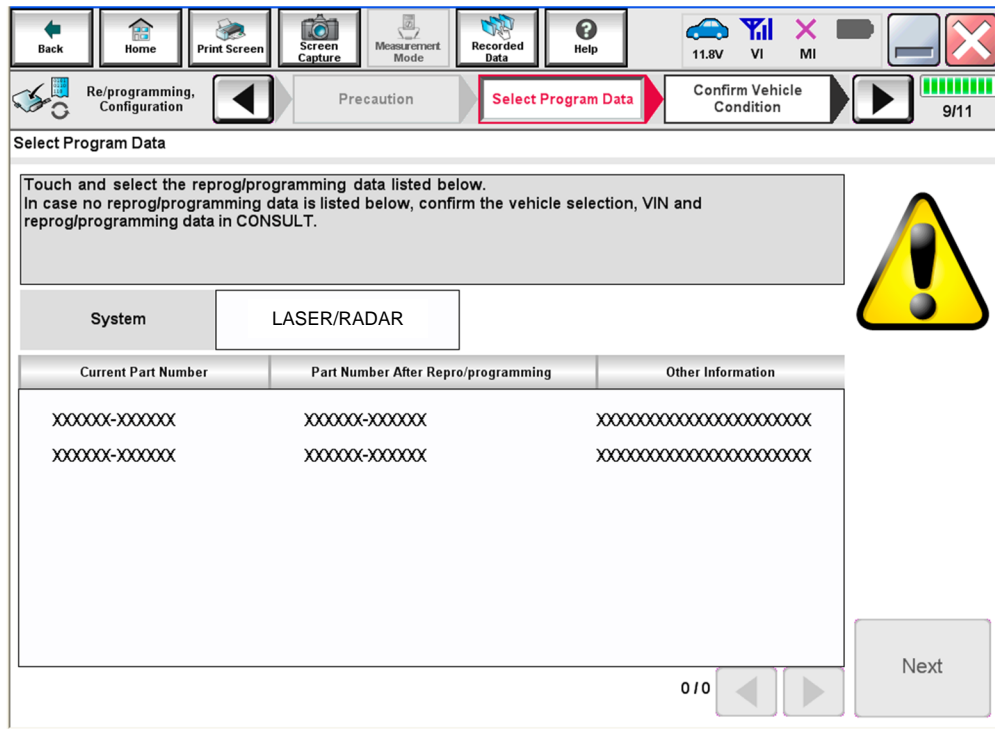

Figure 13

27. Make sure **OK** is highlighted **green** (battery voltage must be between **12.0 and 15.5 Volts**).
28. Select **Next**.

NOTICE

Battery voltage must stay between **12.0 and 15.5 Volts** during reprogramming or reprogramming may be interrupted and the control unit may be damaged.

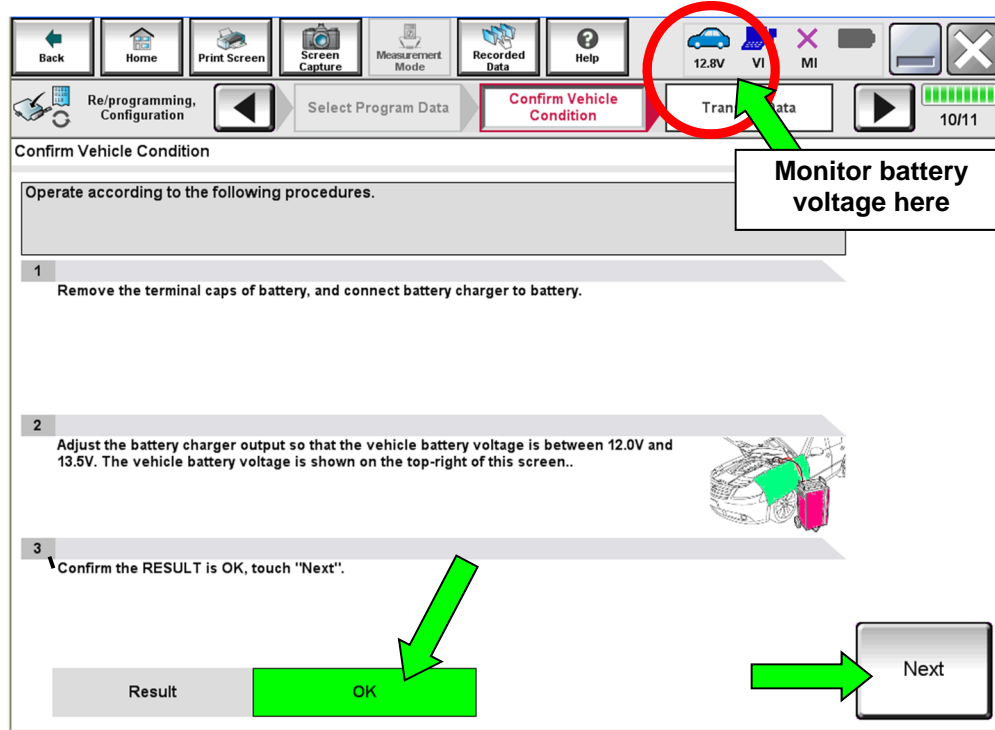

Figure 14

29. Confirm all Judgment items are **OK**, then select **Start**.

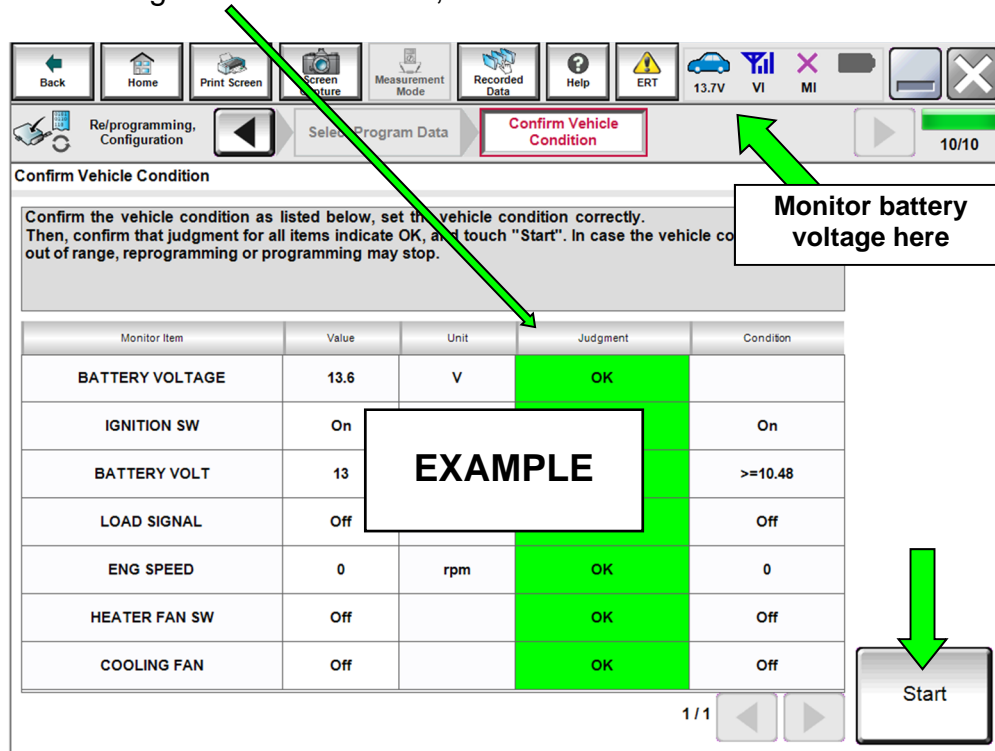

Figure 15

30. Select **USA/CANADA Dealers**.

31. Select **OK**.

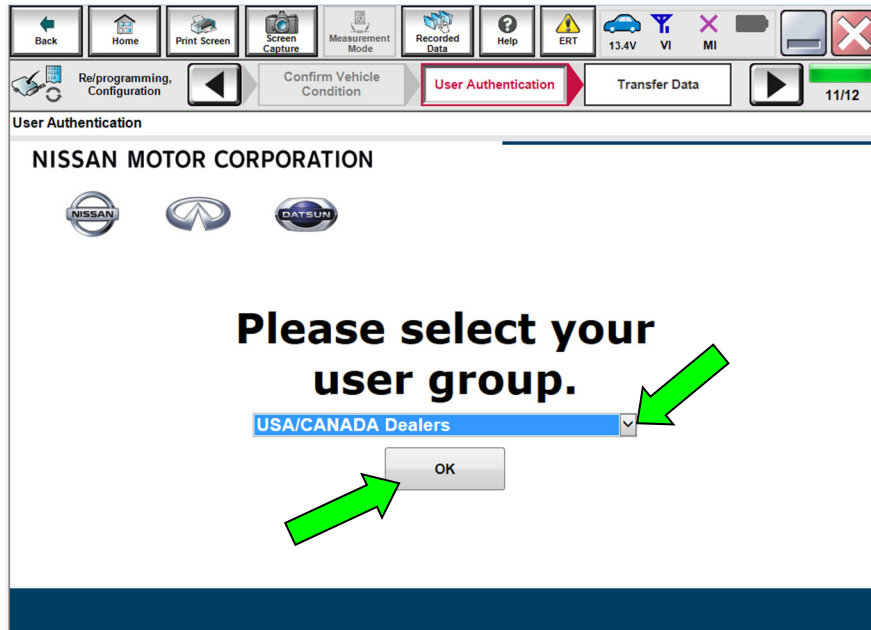

Figure 16

HINT:

- The above screen may not display if the CONSULT PC has remained ON since the last reprogramming.
- If the CONSULT PC is not connected to the Internet, the screen in Figure 17 will display.

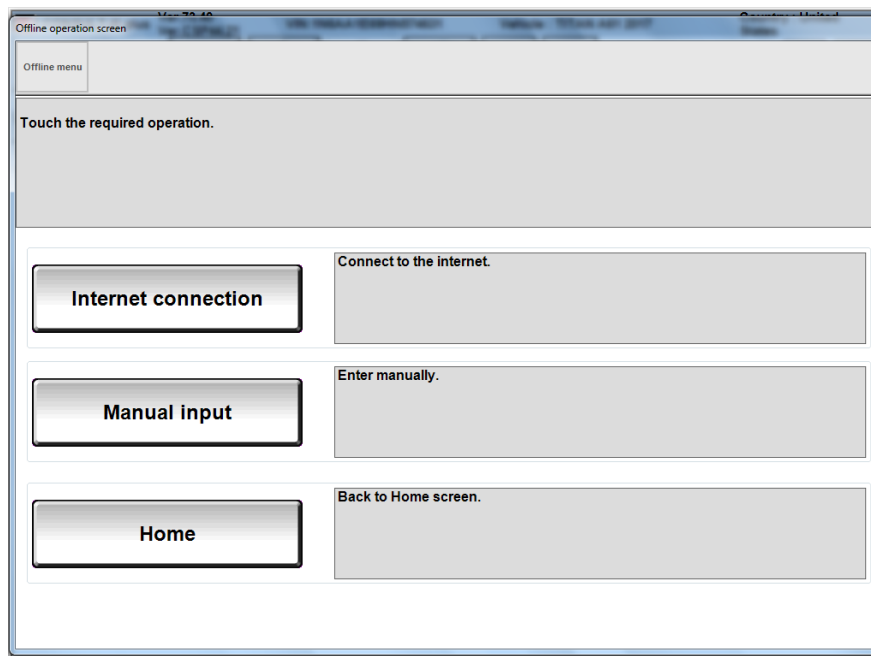

Figure 17

HINT: In the next steps, the reprogramming process will begin when **Submit** is selected.

32. Enter your **Username** and **Password**.

- The CONSULT PC must be connected to the Internet via cable or Wi-Fi.
- If you do not know your User Name and Password, contact your Service Manager.

33. Select **Submit**.

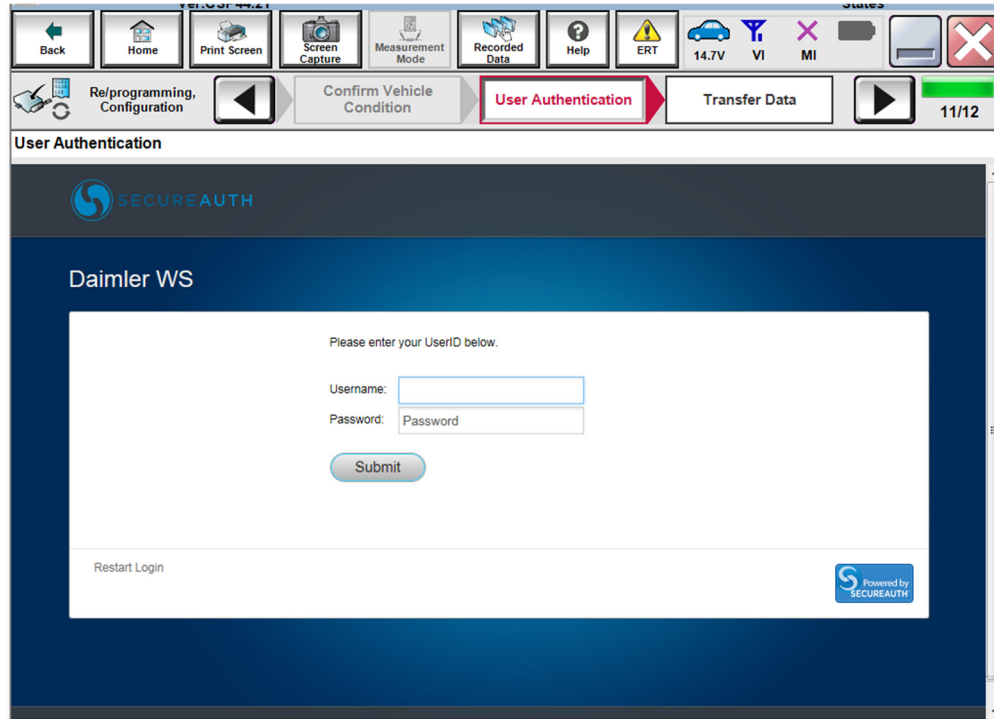

Figure 18

34. Wait for both progress bars to complete.

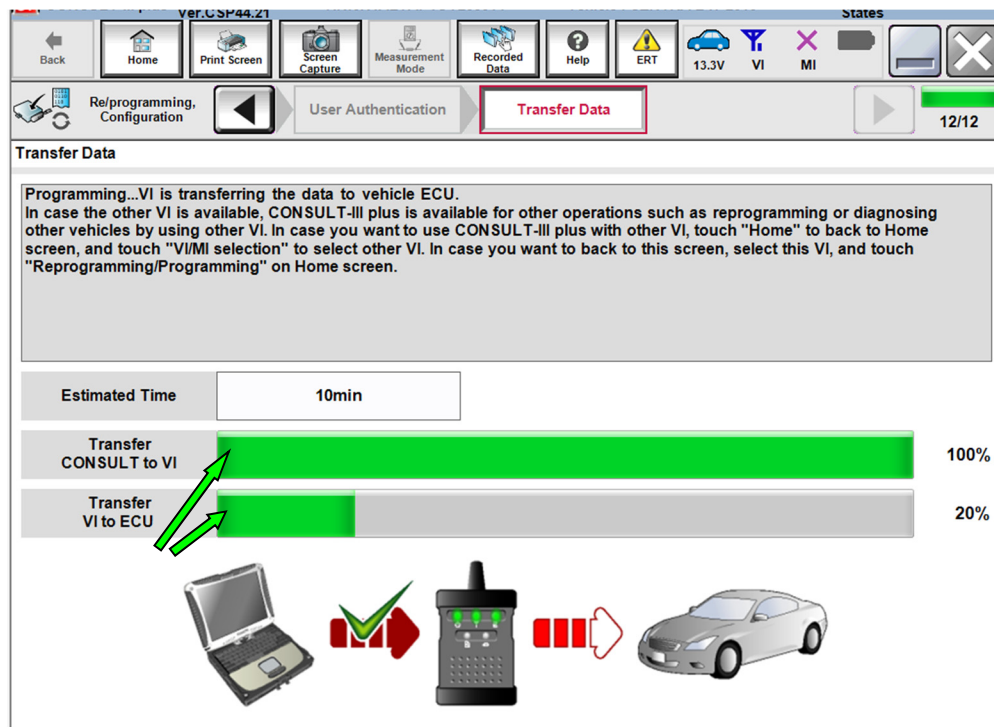

Figure 19

- 35. When the screen in Figure 20 displays, the reprogramming is complete.
HINT: If the screen in Figure 20 does not display (indicating that reprogramming did not complete), refer to **Laser/Radar Recovery** on the next page.

- 36. Disconnect the battery maintainer or smart charger from the vehicle.

- 37. Select **Next**.

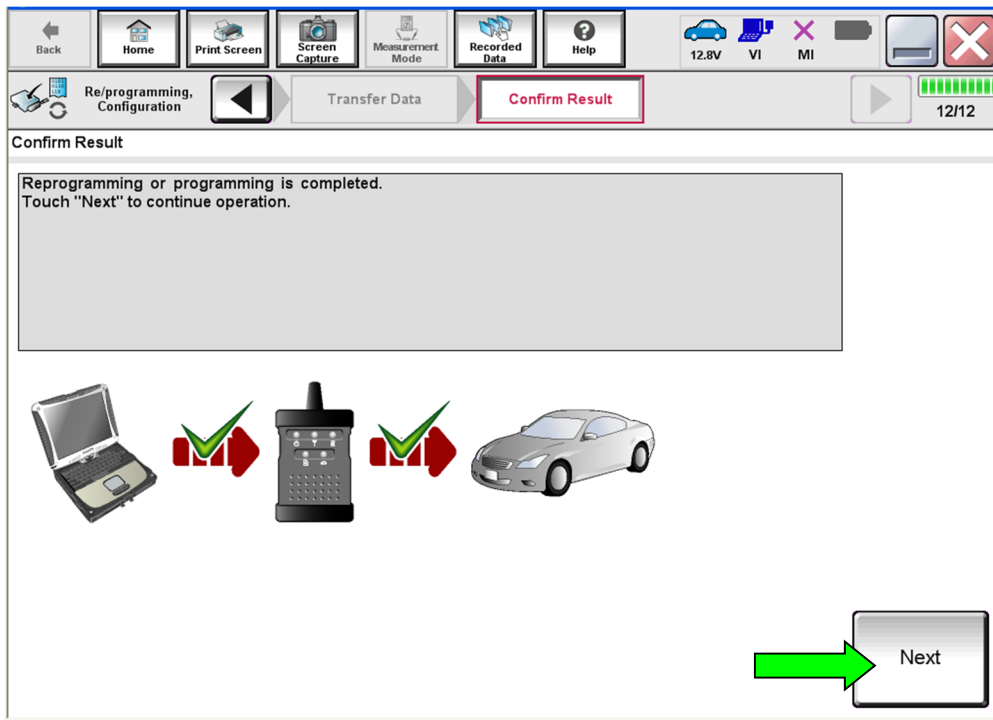

Figure 20

HINT: Additional steps/operations are required before C-III plus will provide the final reprogramming confirmation report. Continue with the reprogramming procedure on page 18.

Laser/Radar Recovery

Do not disconnect plus VI or shut down Consult III plus if reprogramming does not complete.

If reprogramming does not complete and the “!?” icon displays as shown in Figure 21:

- Check battery voltage (12.0 - 15.5 V).
- Ignition is ON, engine OFF.
- External Bluetooth® devices are OFF.
- All electrical loads are OFF.
- **Select retry and follow the on screen instructions.**
- **“Retry” may not go through on first attempt and can be selected more than once.**

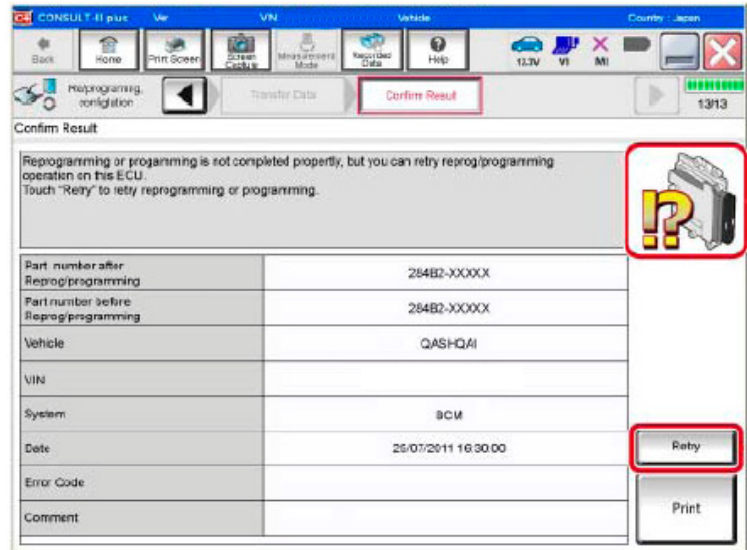

Figure 21

If reprogramming does not complete and the “X” icon displays as shown in Figure 22:

- Check battery voltage (12.0 - 15.5 V).
- CONSULT A/C adapter is plugged in.
- Ignition is ON, engine OFF.
- Transmission is in Park.
- All C-III plus / VI cables are securely connected.
- All C-III plus updates are installed.
- **Select Home, and restart the reprogram procedure from the beginning.**

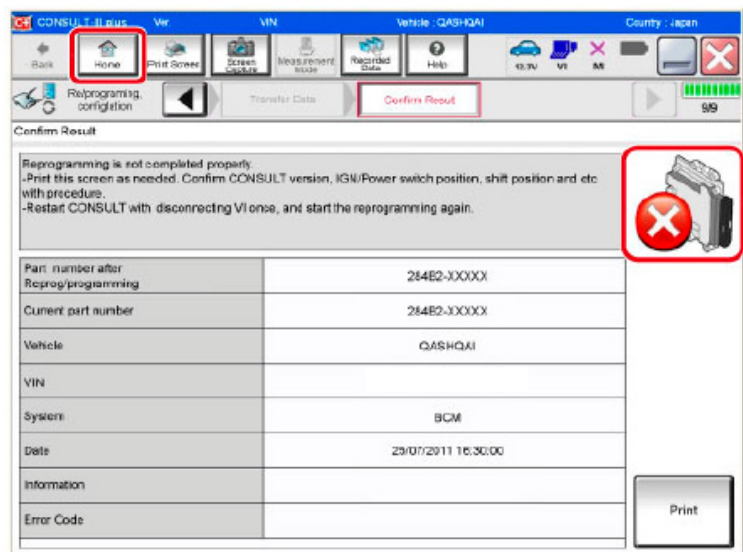

Figure 22

38. **Erase all DTCs** as follows:
- a. Turn the ignition OFF.
 - b. Turn the ignition ON.
 - c. Wait for DTC erase to complete.

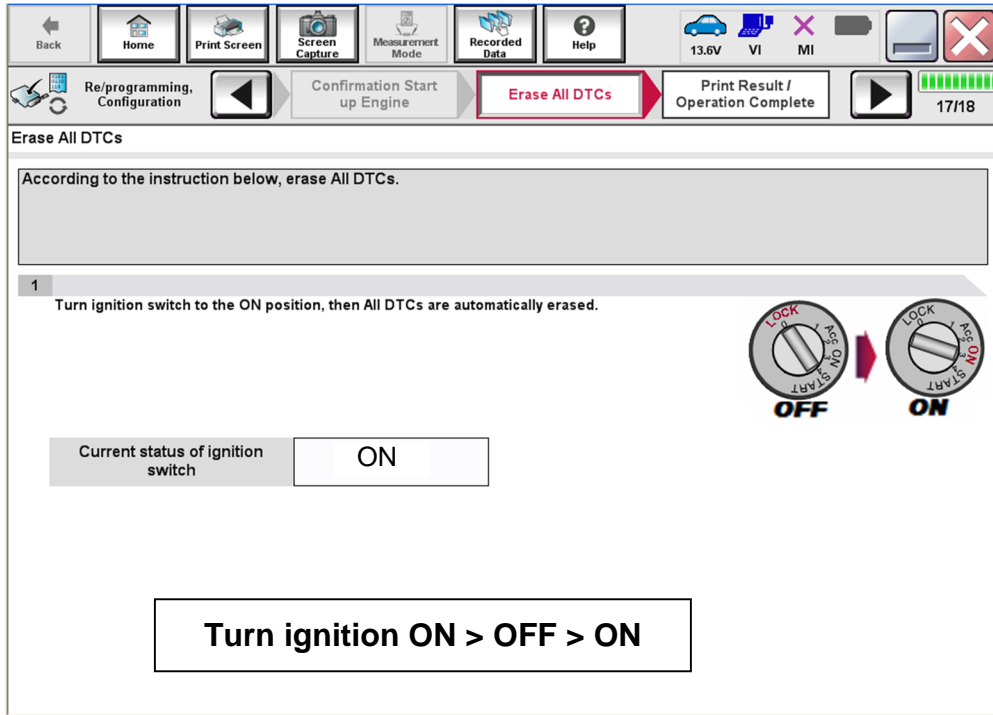

Figure 23

39. Verify the before and after part numbers are different.
40. Print a copy of this screen (Figure 24) and attach it to the repair order for warranty documentation.

HINT: If you cannot print the screen:

- a. Select Screen Capture.
- b. Name the file.
- c. Save the file in My Documents.
 - A copy of the screen is now saved in the CONSULT PC. It can be retrieved and printed at a later time.

41. Select **Confirm**.

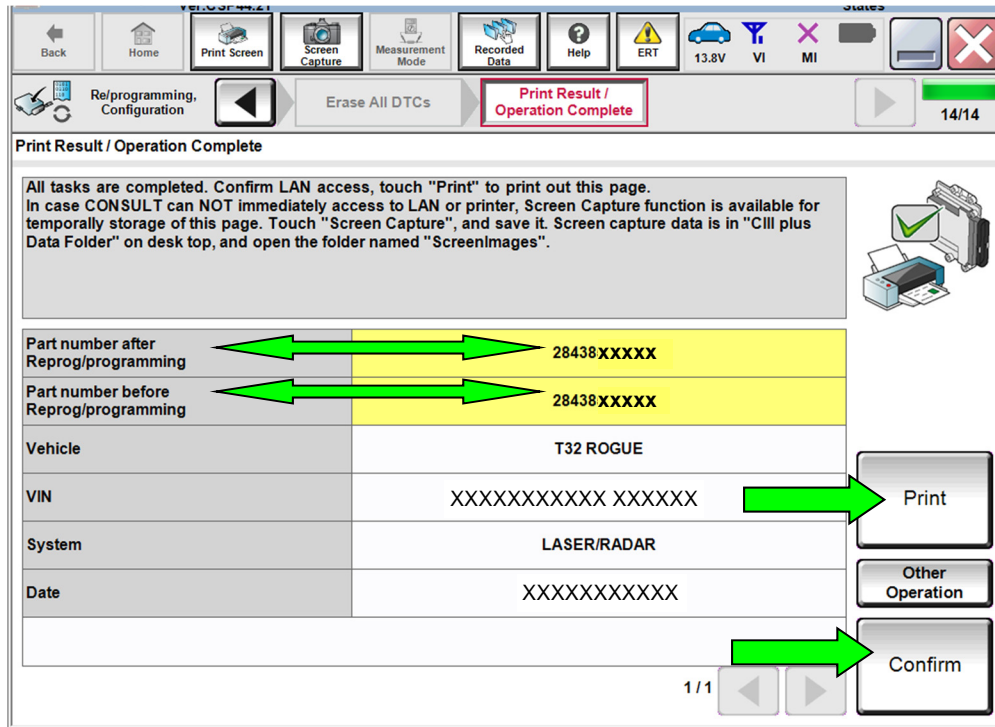

Figure 24

ICC/ADAS Reprogramming

HINT: LASER/RADAR control unit reprogramming must be performed first (if indicated by the flow chart on page 9) before proceeding.

42. Refer to steps 1-18 starting on page 3 to navigate to Figure 25.
43. Select **ICC/ADAS**.

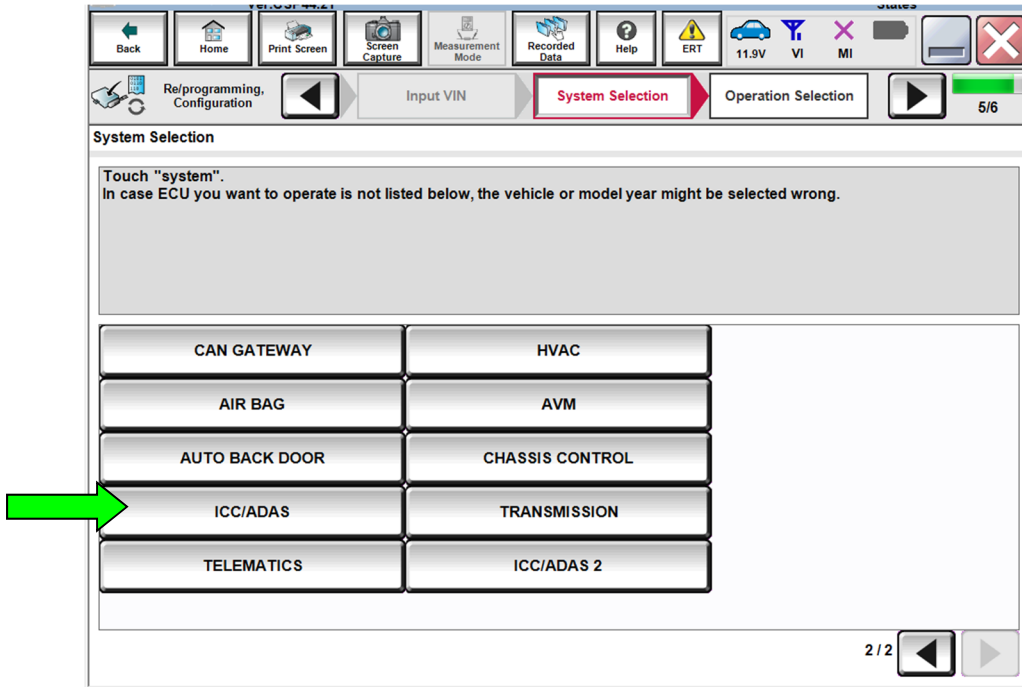

Figure 25

44. Select **Reprogramming**.

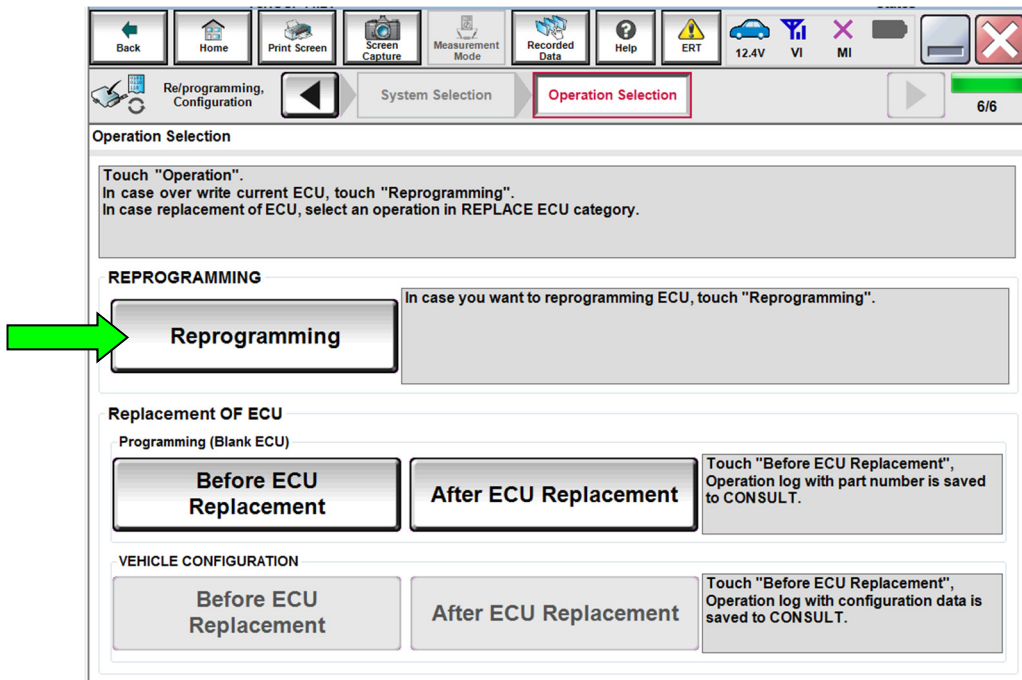

Figure 26

45. When you get to the screen shown in Figure 27, confirm that a reprogram is available as follows.
- A. Find the ICC/ADAS **Part Number** and write it on the repair order.
- HINT:** This is the current ICC/ADAS Part Number (P/N).

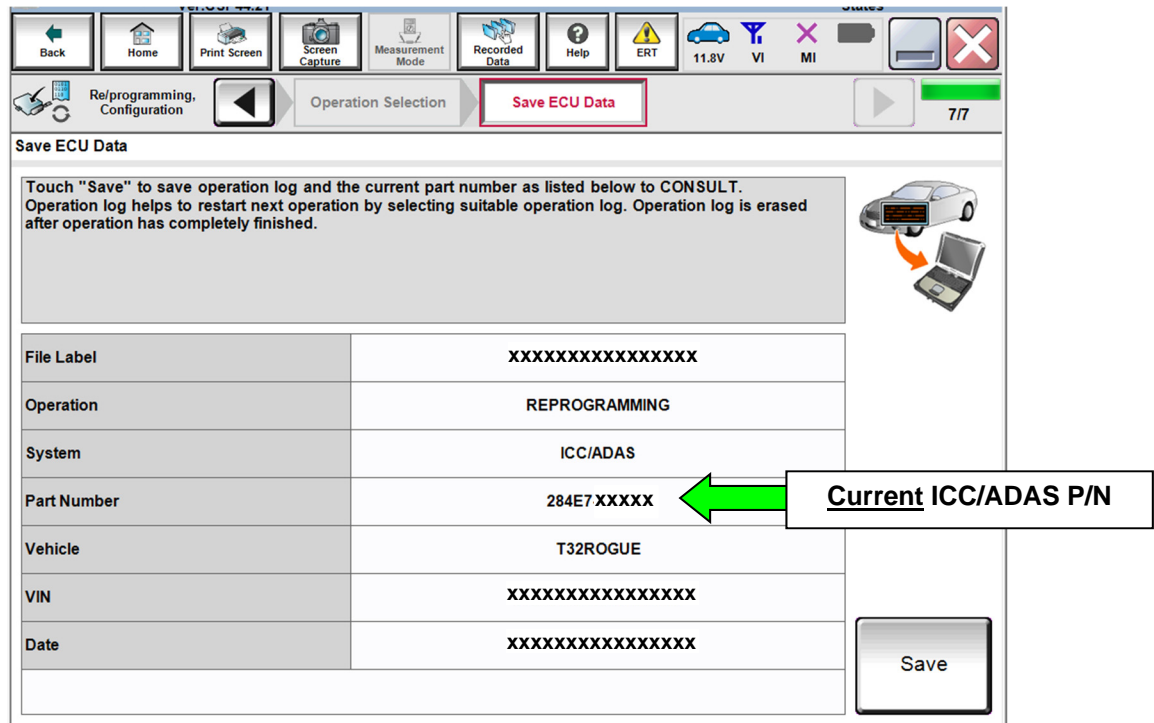

Figure 27

- B. Compare the P/N you wrote down to the numbers in the **Current ICC/ADAS Part Number** column in **Table A**.
- If there is a match, continue with the reprogramming procedure.
 - If there is not a match in Table A, proceed to step 55 on page 26.

Table A

MODEL	YEAR	CURRENT ICC/ADAS PART NUMBER: 284E7-
Rogue and Rogue Hybrid	2017	6FL1B, 6FL2B, 6FL7B, 6FL8B
		7FF7B, 7FF8B
	2018	5HR0A, 5HR9A
		5HR9B
		5HR0C
		5HR0E, 5HR1E, 5HR3E, 5HR5E, 5HR6E
Rogue Sport	2017	6MA0B
	2018	6MA1B
		6MG0A, 6MG1A, 6MG2A

46. Follow the on-screen instructions to navigate C-III plus and reprogram the ICC/ADAS control unit.
- Refer to steps 21-34 starting on page 10 for further details.

HINT:

- In some cases, more than one new P/N for reprogramming is available.
 - If more than one new P/N is available, the screen in Figure 28 displays.
 - Select and use the reprogramming option that does **not** have the message “Caution! Use ONLY with NTBXX-XXX”.
- If you get this screen and it is blank (no reprogramming listed), it means there is no reprogramming available for this vehicle. Skip to step 55 on page 26.

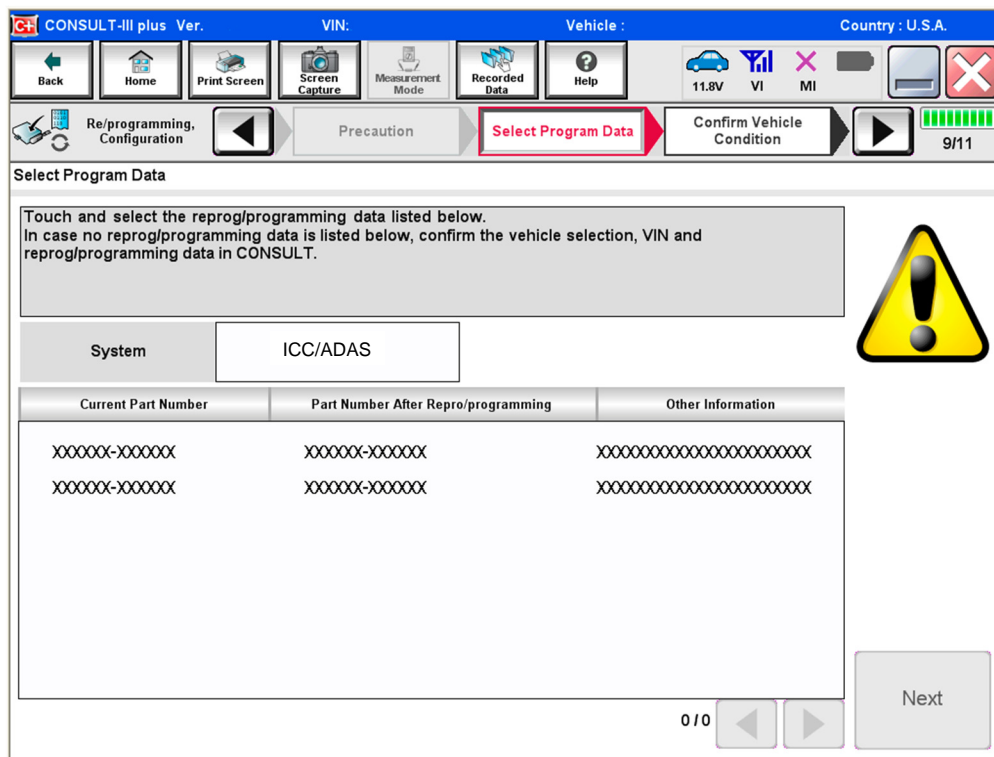

Figure 28

47. When the screen in Figure 29 displays, reprogramming is complete.
HINT: If the screen in Figure 29 does not display (indicating that reprogramming did not complete), refer to ICC/ADAS Control Unit Recovery on the next page.
48. Disconnect the battery maintainer or smart charger from the vehicle.
49. Select **Next**.

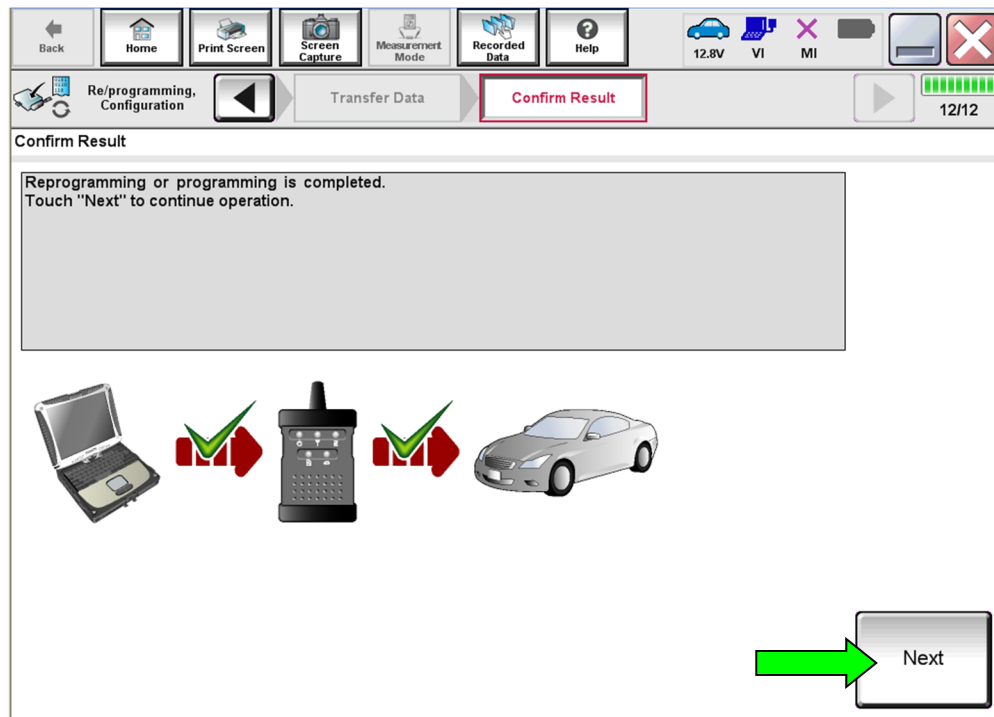

Figure 29

HINT: Additional steps/operations are required before C-III plus will provide the final reprogramming confirmation report. Continue with the reprogramming procedure on page 25.

ICC/ADAS Control Unit Recovery

Do not disconnect plus VI or shut down Consult III plus if reprogramming does not complete.

If reprogramming does not complete and the “!?” icon displays as shown in Figure 30:

- Check battery voltage (12.0 - 15.5 V).
- Ignition is ON, engine OFF.
- External Bluetooth® devices are OFF.
- All electrical loads are OFF.
- **Select retry and follow the on screen instructions.**
- “Retry” may not go through on first attempt and can be selected more than once.

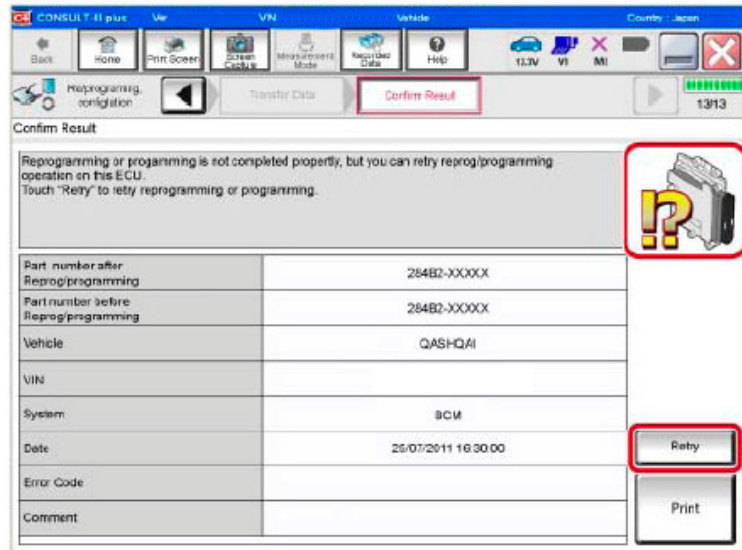

Figure 30

If reprogramming does not complete and the “X” icon displays as shown in Figure 31:

- Check battery voltage (12.0 - 15.5 V).
- CONSULT A/C adapter is plugged in.
- Ignition is ON, engine OFF.
- Transmission is in Park.
- All C-III plus / VI cables are securely connected.
- All C-III plus updates are installed.
- **Select Home, and restart the reprogram procedure from the beginning.**

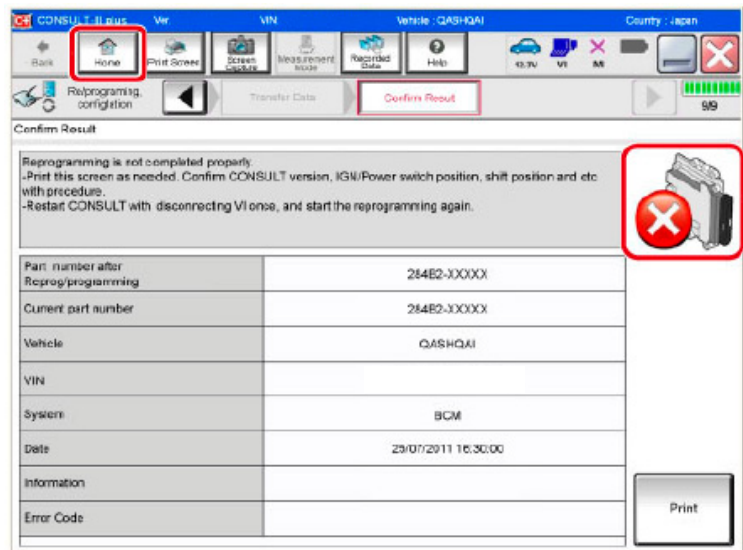

Figure 31

50. Follow the on on-screen instructions to erase DTCs.
 - If needed, refer to step 38 on page 18 for further details.
51. When the entire reprogramming process is complete, the screen in Figure 32 will display.
52. Verify the before and after part numbers are different.
53. Print a copy of the screen shown below (Figure 32) and attach it to the repair order for warranty documentation.

HINT: If you cannot print the screen:

- a. Select **Screen Capture**.
- b. **Name** the file.
- c. **Save** the file in My Documents.
 - A copy of the screen is now saved in the CONSULT PC. It can be retrieved and printed at a later time.

54. Select **Confirm**.

Screen Capture

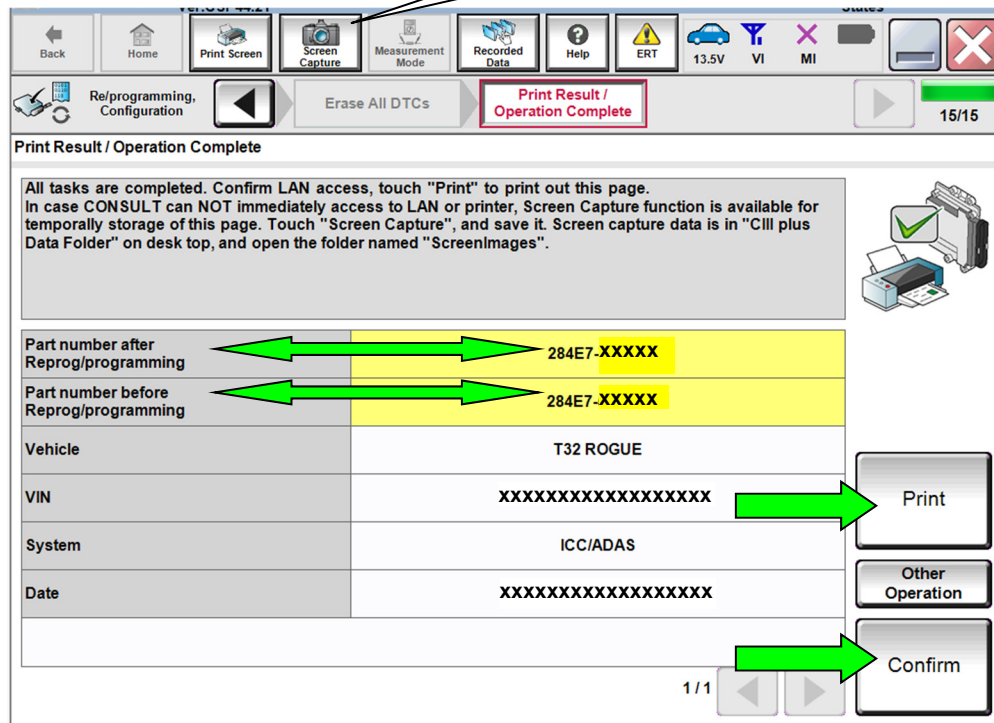

Figure 32

55. Close C-III plus.
56. Turn the ignition OFF.
57. Disconnect the plus VI from the vehicle.
58. Test drive the vehicle and make sure it operates correctly and the related warning lights are OFF.
 - If any related warning lights come ON, go back to ASIST for further diagnostic information.
 - Diagnosis and repairs beyond ICC/ADAS or LASER/RADAR reprogramming or replacement are not covered by this campaign bulletin.

CLAIMS INFORMATION

Submit a campaign (CM) type line claim using the following claims coding:

CAMPAIGN ("CM") ID	DESCRIPTION	OP CODE	FRT
P9327	Reprogram Laser/Radar Control Unit AND ICC/ADAS Control Unit	P93270	0.7 hrs.
	Reprogram ICC/ADAS Control Unit	P93271	0.4 hrs.
	Reprogram Laser/Radar Control Unit	P93272	0.4 hrs.
	Reprogramming not needed	P93275	0.3 hrs.

AMENDMENT HISTORY

PUBLISHED DATE	REFERENCE	DESCRIPTION
August 26, 2019	NTB19-064	Original bulletin published
September 5, 2019	NTB19-064a	Part Numbers added to pages 2 and 9
September 20, 2019	NTB19-064b	CLAIMS INFORMATION section revised
February 2, 2021	NTB19-064c	Classification number updated