



SAFETY RECALL BULLETIN

SUBJECT: CROSSMEMBER CORROSION - SAFETY RECALL CAMPAIGN			No: SR-21-001
			DATE: March 2021
			MODEL: SEE BELOW
CIRCULATE TO:	<input checked="" type="checkbox"/> GENERAL MANAGER	<input checked="" type="checkbox"/> PARTS MANAGER	<input checked="" type="checkbox"/> TECHNICIAN
<input checked="" type="checkbox"/> SERVICE ADVISOR	<input checked="" type="checkbox"/> SERVICE MANAGER	<input checked="" type="checkbox"/> WARRANTY PROCESSOR	<input checked="" type="checkbox"/> SALES MANAGER

PURPOSE

This bulletin provides directions for inspection and repair of affected vehicles' Crossmembers.

BACKGROUND

The inside and outside surfaces of the Front Crossmembers used on certain vehicles, if exposed long term to snow melt water and anti-freezing agents, may corrode due to insufficient performance of the rust protection. Should significant corrosion occur over time, a lower control arm could eventually become detached resulting in loss of vehicle control and a potential collision.

AFFECTED VEHICLES

Certain 2013 – 2015 Outlander Sport*

*Currently or ever registered in Connecticut, Delaware, Illinois, Indiana, Iowa, Kentucky, Maine, Maryland, Massachusetts, Michigan, Minnesota, Missouri, New Hampshire, New Jersey, New York, Ohio, Pennsylvania, Rhode Island, Vermont, Virginia, West Virginia, Wisconsin, and Washington D.C.

IMPORTANT

Affected new or used inventory vehicles must be repaired before the vehicle is delivered. Dealers must check their inventory vehicles' VINs on the Warranty Superscreen to verify whether the vehicle is involved in this recall campaign. It is a violation of Federal law for a dealer to deliver a new motor vehicle or any new or used item of motor vehicle equipment (including a tire) covered by the notification under a sale or lease until the defect or noncompliance is remedied.

NOTE: If you encounter a vehicle which has excessive Crossmember corrosion, but is not covered under this campaign (i.e., never registered in a salt belt state), contact your DPSM for further directions.











Copyright 2021, Mitsubishi Motors North America, Inc.

The information contained in this bulletin is subject to change. For the latest version of this document, go to the Mitsubishi Dealer Link, MEDIC, or the Mitsubishi Service Information website (www.mitsubishitechinfo.com).

(5076)

REQUIRED TOOLS, EQUIPMENT AND MATERIALS

1. Obtain necessary tools, equipment and materials.
2. Dealers that do not already have the Spray Gun, Regulator or Anti-Corrosion agents listed below, should order through their facing PDC.

Picture	Name / Part number	Remark
	Corrugated Paper	For masking
	Universal Absorbent Pads	For masking and wiping off too much anti-corrosion agent
	Hammer, 1 Pound	
	Punch	
	Protective Gloves	
	Respirator	
	Safety Glasses	
	Scraper Flathead Screwdriver Wire Brush	For rust removal
	Air Coupler	
	Air Compressor	
	Air Gun	
	Spray Gun for Internal Application: MZ341023EX T99XXXXX01	Clean spray gun after using
	Air Regulator for use with MZ341023EX	
	Anti-Corrosion Agent for Internal Application of: MZ321015 (Used in Canada)	1 liter – Target amount of usage: 5 vehicles per bottle
	Anti-Corrosion Agent for Internal Application: MZ341024EX (Used in US)	1 liter – Target amount of usage : 5 vehicles per bottle
	Anti-Corrosion Agent for External Application: MZ320800	0.48 liter – Target amount of usage: 5 vehicles per aerosol can

!! IMPORTANT !!

Inspect consistency of the Anti-Corrosion Agent (P/N: MZ341024EX) before use. The consistency should be smooth and creamy. If the consistency is chunky (like cottage cheese) do not use and discard the product.

ANTI-CORROSION AGENT SPRAY GUN PART #:	MZ341024EX - ANTI-CORROSION AGENT	MZ321015 (Canada) - ANTI-CORROSION AGENT
MZ341023EX	Reference Page 12	Reference Page 15
T99XXKXX01	Reference Page 17	Reference Page 22

FLOW CHART

2. Review flow chart

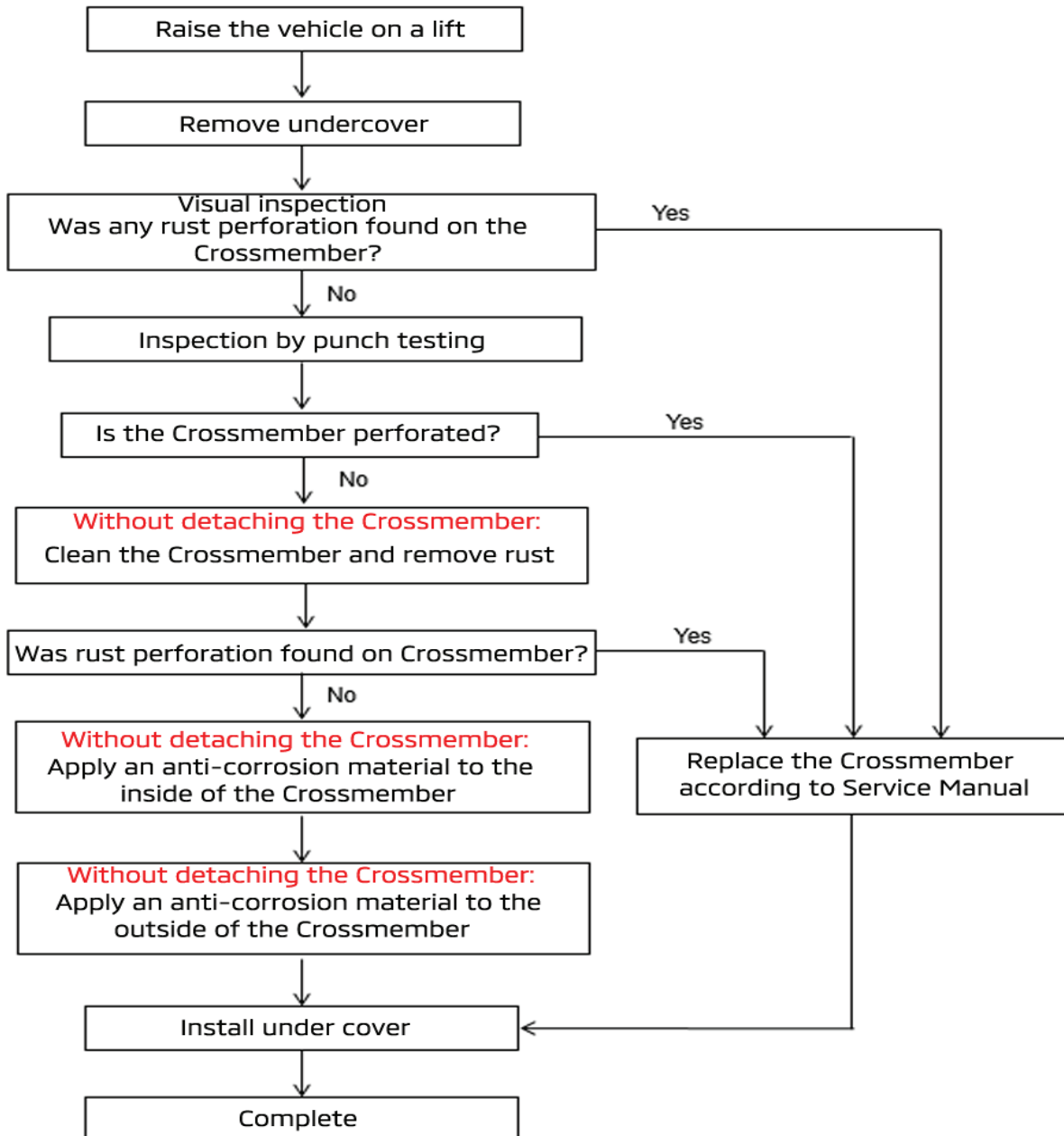

INSPECTION PROCEDURE

3. Raise the vehicle on a lift.
4. Remove under cover clips and under cover.

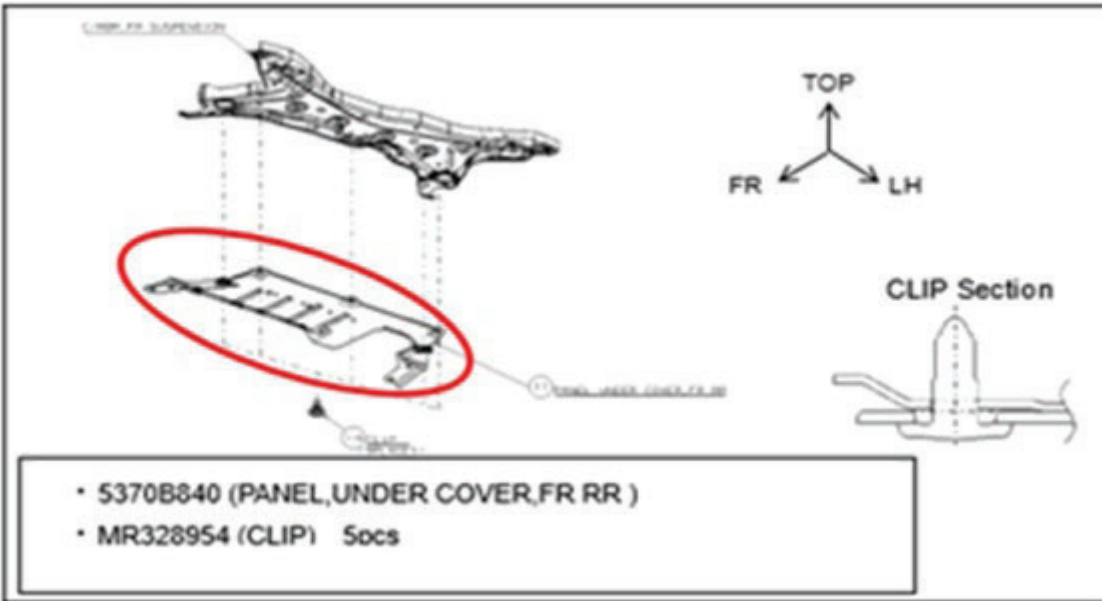

5. Inspection by punch testing.
 - a. Prepare punch and hammer.

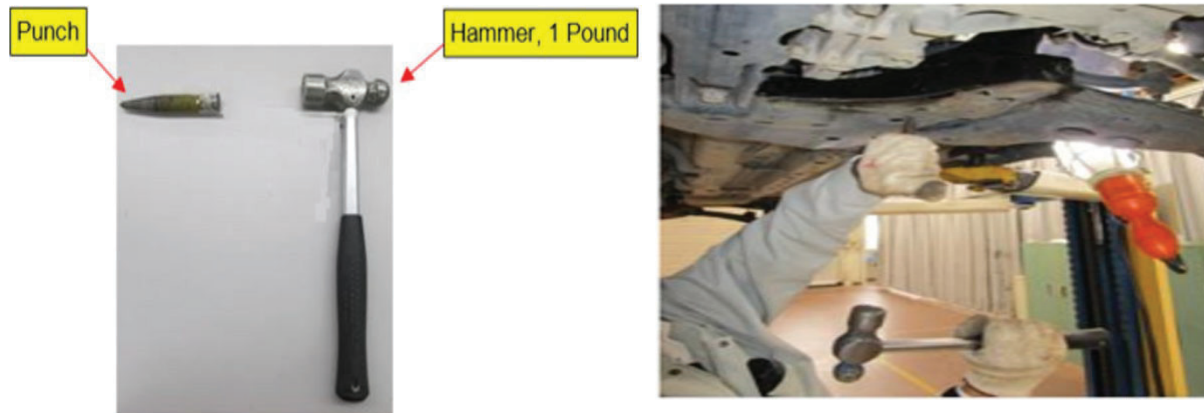

- b. Put the punch on the points shown below and strike the punch 5 times with the hammer. The punching point is located approximately 20mm from the weld and outward approximately 10mm from the pipe on the left and right sides, as shown below.
 - c. If the Crossmember becomes perforated, please replace the Crossmember.

NOTE: Crossmember removed from vehicle for illustration purposes.

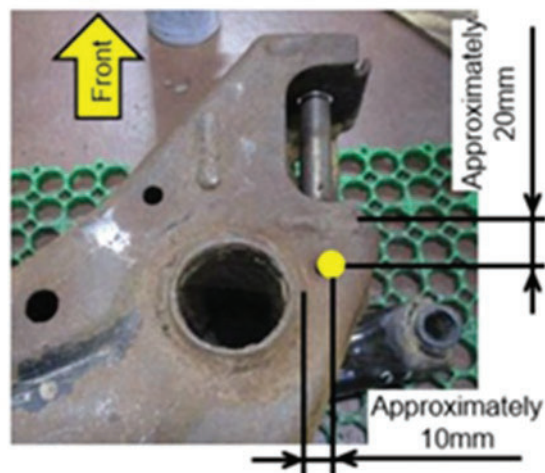

Wear safety glasses, respirator, and protective gloves when punching, removing rust and cleaning the Crossmember.

6. Clean the Crossmember and remove rust without removing the Crossmember from the vehicle.
 - a. Remove any dirt, mud and water from outside and inside of the Crossmember by using compressed air.
 - b. Remove loose rust and rust scales from the external surface of the Crossmember by using a scraper, chisel, or flathead screwdriver.

- c. Remove any remaining rust or dirt from the Crossmember by using a wire brush until the surface is smooth and clean.
- d. Visually inspect the Crossmember during the rust removal process. If rust perforation is found, proceed to the Crossmember replacement.

NOTE: Crossmember removed from vehicle for illustration purposes only, in the photos below.

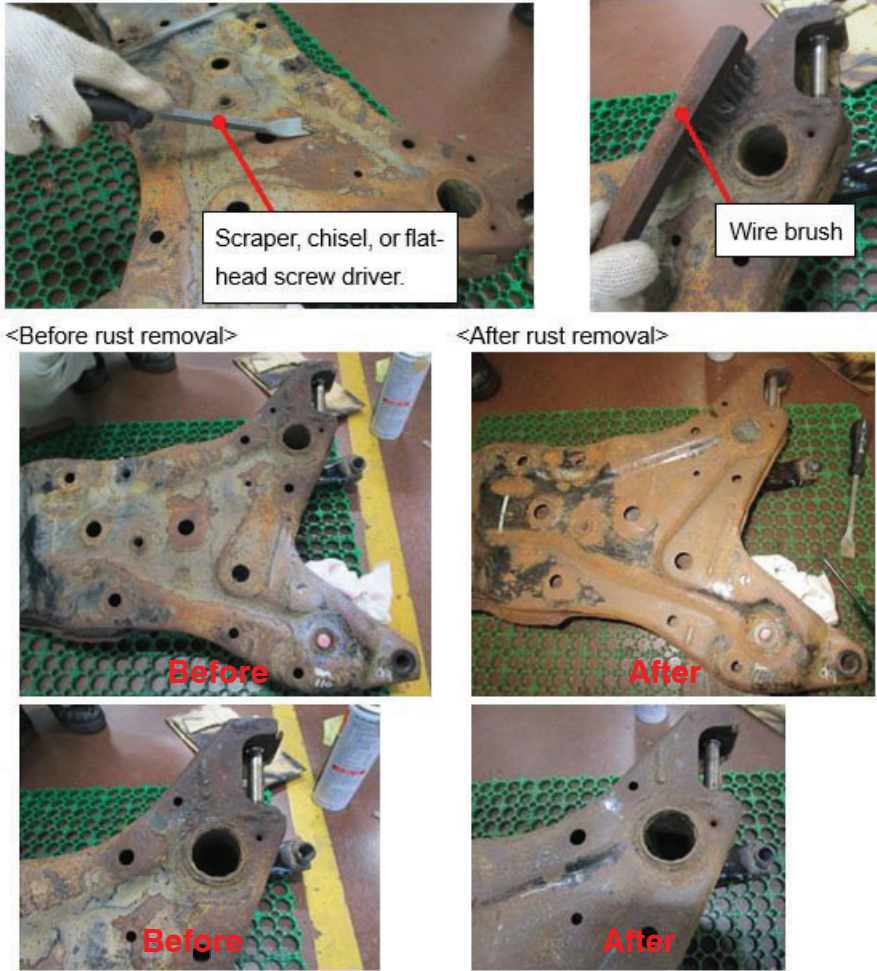

Application of anti-corrosion agent to the inside of the Crossmember

1. When using **MZ341023EX** spray gun, prepare for internal application, as follows:
 - a. Assemble the spray gun as illustrated below.
 - b. Set zero-point of discharge and air adjustment knobs.
 - c. Remove the cap of the container and fill the container with anti-corrosion agent. Attach the cap to the container.

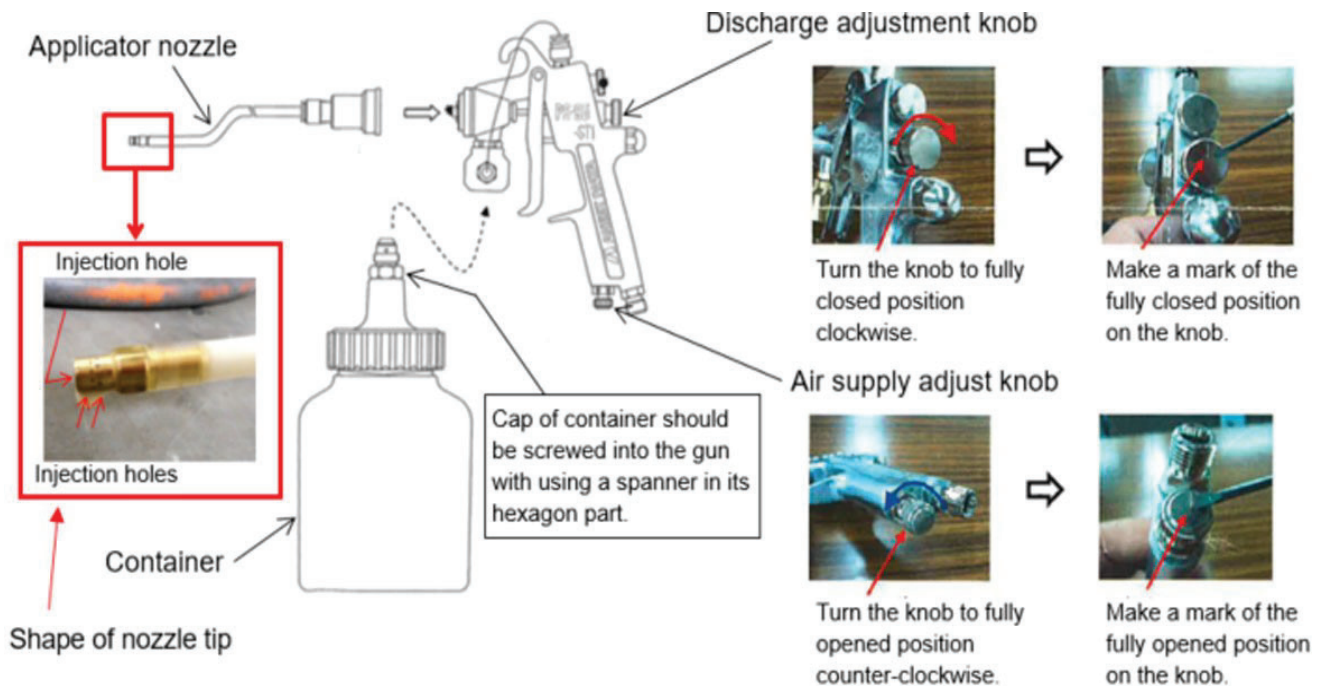

- d. Attach the air regulator and hose to the gun.
- e. Adjust the discharge and the air adjustment knobs.
- f. Adjust the compressor air pressure.

	Discharge adjustment knob		Open from fully closed position 1/2 turn (in summer) to 4 turns (in winter)
	Air supply adjust knob		Close from fully opened position 1 turn
	Compressor air pressure		51 PSI (350 KPa) (in summer) to 71 PSI (490 KPa) (in winter) Never exceed 71 PSI.

- g. Test the spray gun by fully engaging the gun trigger to confirm anti-corrosion agent is injected from nozzle.



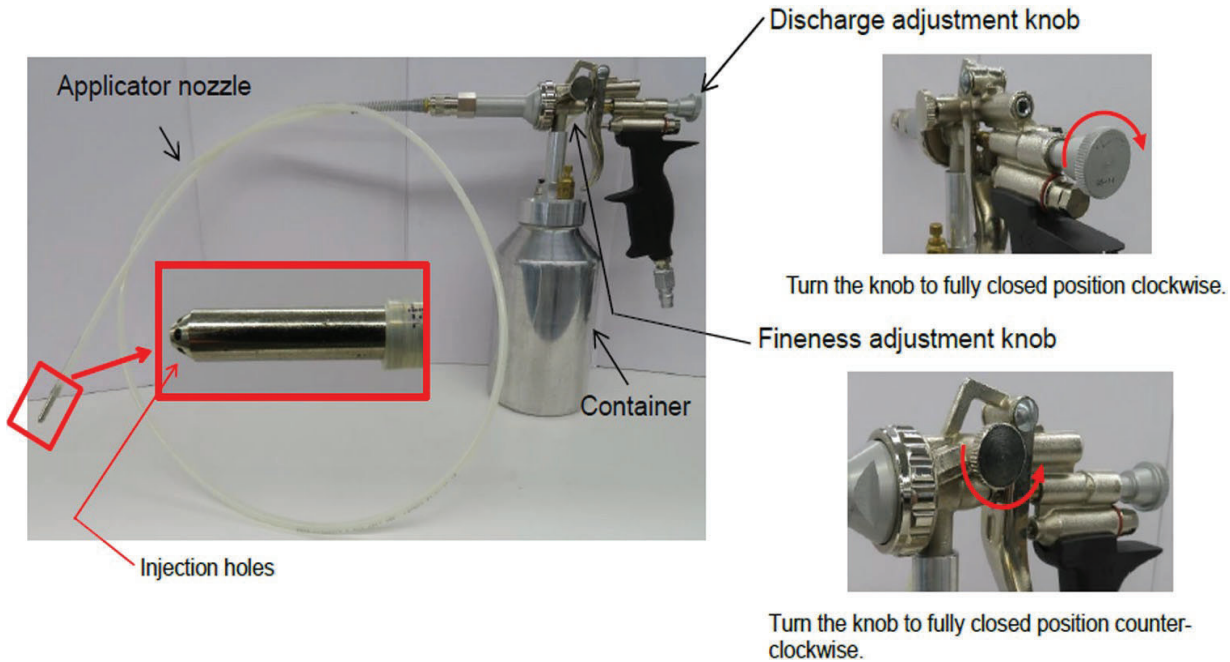

Wear safety glasses when applying anti-corrosion agent.

2. When using the **T99XXKXX01** spray gun with **MZ321015 (used in Canada)**, prepare for internal application, as follows:
 - a. Assemble the spray gun as illustrated below.
 - b. Set zero-point of discharge and air supply adjustment knob.



- c. Remove the cap on the gun container and fill with anti-corrosion agent.
- d. Attach the air regulator and hose to the gun.
- e. Adjust the discharge and fineness adjustment knob.



Discharge adjustment knob		Open from fully closed position 3 turns.
Fineness adjustment knob		Open from fully closed position 2 and 1/4 turns.
Compressor air pressure		51 PSI (350 KPa) (in summer) to 71 PSI (490 KPa) (in winter) Never exceed 71 PSI

- f. Adjust compressor air pressure.
- g. Test the spray gun by fully engaging the gun trigger to confirm anti-corrosion agent is injected from nozzle.



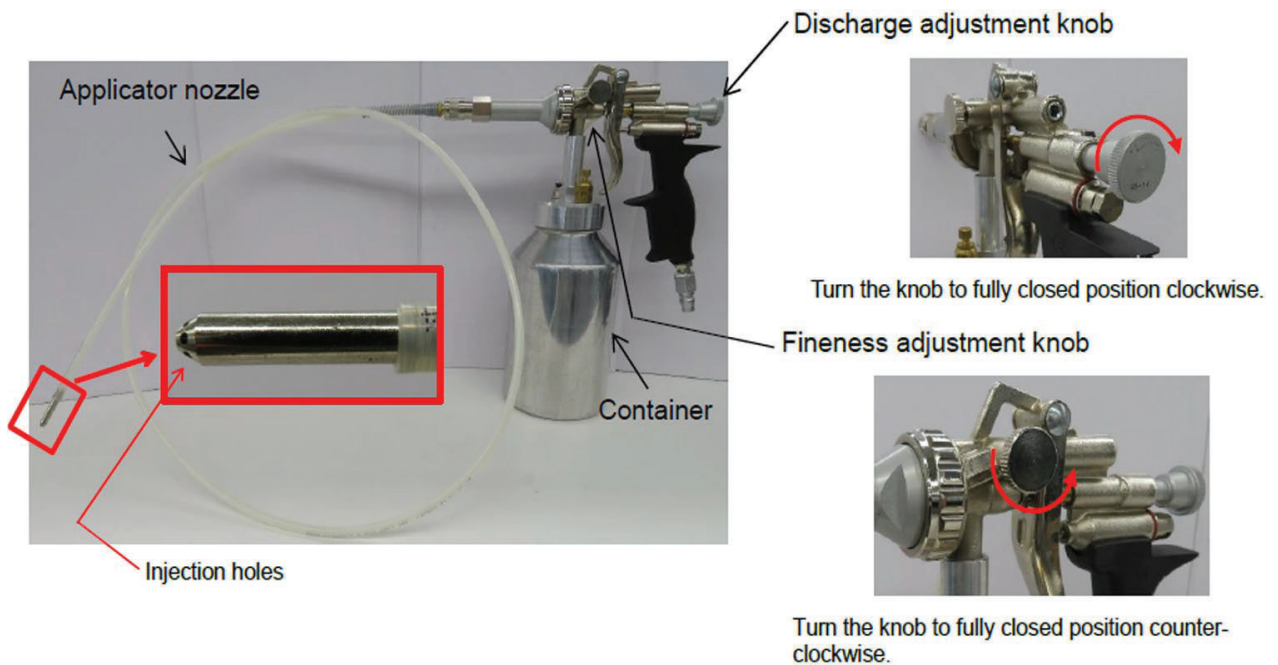

Wear safety glasses when applying anti-corrosion agent.

3. When using the **T99XXKXX01** spray gun with **MZ341024EX**, prepare for internal application, as follows:
 - a. Assemble the spray gun as illustrated below.
 - b. Set zero-point of discharge and air supply adjustment knob.



- c. Remove the cap on the gun container and fill with anti-corrosion agent.
- d. Attach the air regulator and hose to the gun.
- e. Adjust the discharge and fineness adjustment knob.



Discharge adjustment knob		Open from fully closed position 4 and 1/2 turns.
Fineness adjustment knob		Open from fully closed position 1 turn.
Compressor air pressure		51 PSI (350 KPa) (in summer) to 71 PSI (490 KPa) (in winter) Never exceed 71 PSI

- f. Adjust compressor air pressure.
- g. Test the spray gun by fully engaging the gun trigger to confirm anti-corrosion agent is injected from nozzle.



Wear safety glasses when applying anti-corrosion agent.

- 4. Anti-corrosion agent internal application should be completed without removing the Crossmember from the vehicle. According to the respective vehicle model, insert the nozzle into each hole as shown below.

13-15MY Outlander Sport					
Anti-Corrosion Agent		MZ341024EX	MZ321015 (used in Canada)	MZ341024EX	MZ321015 (used in Canada)
Spray Gun		MZ341023EX	MZ341023EX	T99XXXXX01	
Spray Gun Setting	Discharge adjustment knob	½ turn (in summer) to 4 turns (in winter)		-	
	Air supply adjustment knob	1 turn			
	Discharge adjustment knob	-		4 and ½ turns	3 turns
	Fineness adjustment knob			1 turn	2 and ¼ turns
	Air pressure	51 PSI (350 Kpa) in summer - to - 71 PSI (490 Kpa) in winter			
Hole A, A'	Insert length of hose (mm)	240		180	
	Spraying time (s)	Until Anti-Corrosion agent leaks from the opening of the lower arm bracket			
	Spraying time during removal	10 seconds			
Hole B, B'	Insert length of hose (mm)	100 mm		70 mm	
	Spraying time (s)	10 seconds			
	Spraying time during removal	10 seconds			
Hole C, C'	Insert length of hose (mm)	25 mm			
	Spraying time (s)	10 seconds			
Hole D	Insert length of hose (mm)	25 mm			
	Spraying time (s)	10 seconds			
Hole E, E'	Insert length of hose (mm)	-		180 mm	
	Spraying time (s)			10 seconds	
	Spraying time during removal			10 seconds	

When using the combination below:

Anti-Corrosion Agent	Spray Gun
MZ341024EX	MZ341023EX
X	X

Nozzle should be inserted into the 7 holes identified:

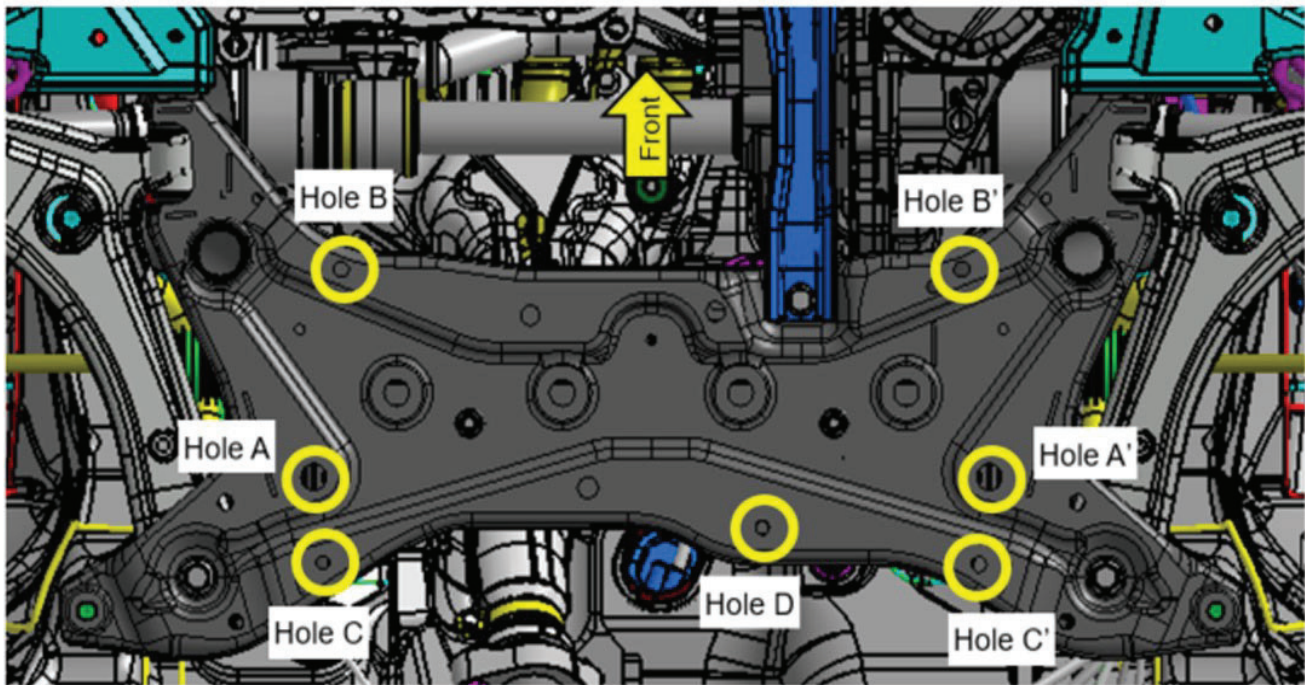

a. Spraying into the Hole A (RH) / A' (LH)

- Insert the nozzle through Hole **A(A')** in the direction shown below until it contacts the lower arm bracket (Insertion length: 240mm or 9.5 inches). Confirm that the nozzle has been fully inserted in the correct direction by looking in the opening of the lower arm bracket.
- Apply **MZ341024EX** by engaging the trigger fully at the position demonstrated below and confirm the **MZ341024EX** leaks out of the opening of the lower arm bracket. Continue spraying while removing the nozzle, which should take 10 seconds.

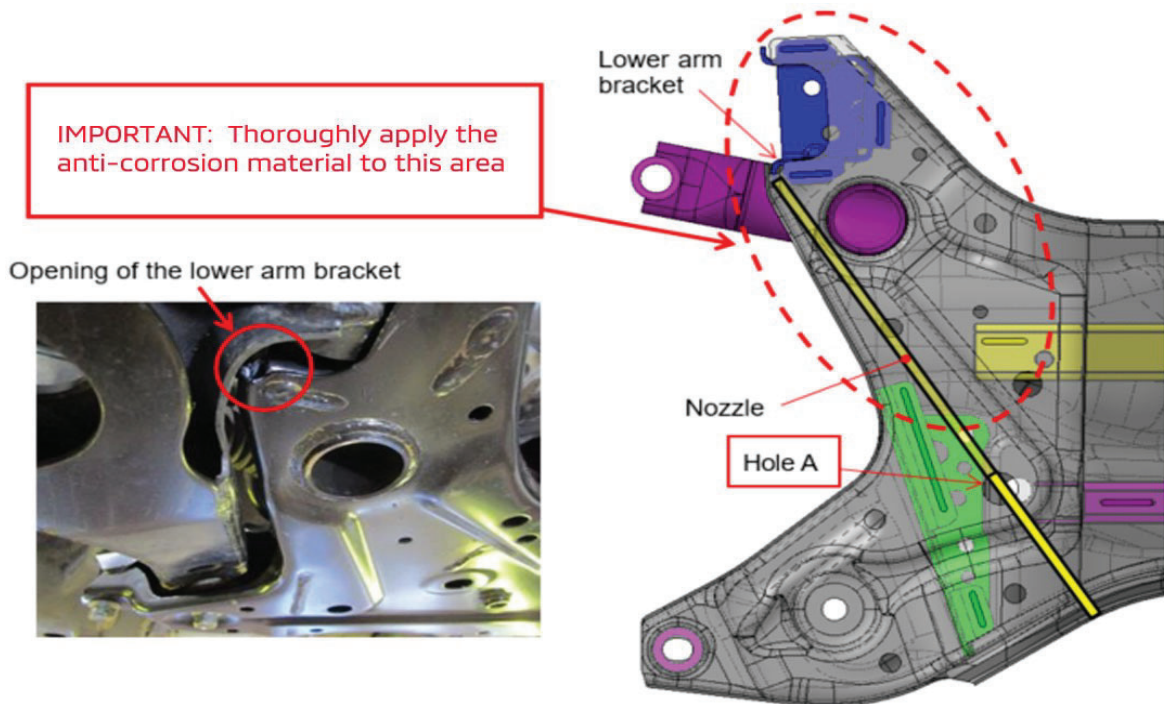

b. Spraying into the Hole B (RH) / B' (LH)

- Insert the nozzle through Hole **B (B')** in the direction shown below until it contacts the lower arm bracket (Insertion length: 100mm or 4 inches). Confirm that the nozzle has been fully inserted in the correction direction by looking in the clip insertion hole.
- Apply **MZ341024EX** fully by engaging the trigger fully at this position for 10 seconds and continue spraying while removing the nozzle, which should take another 10 seconds.

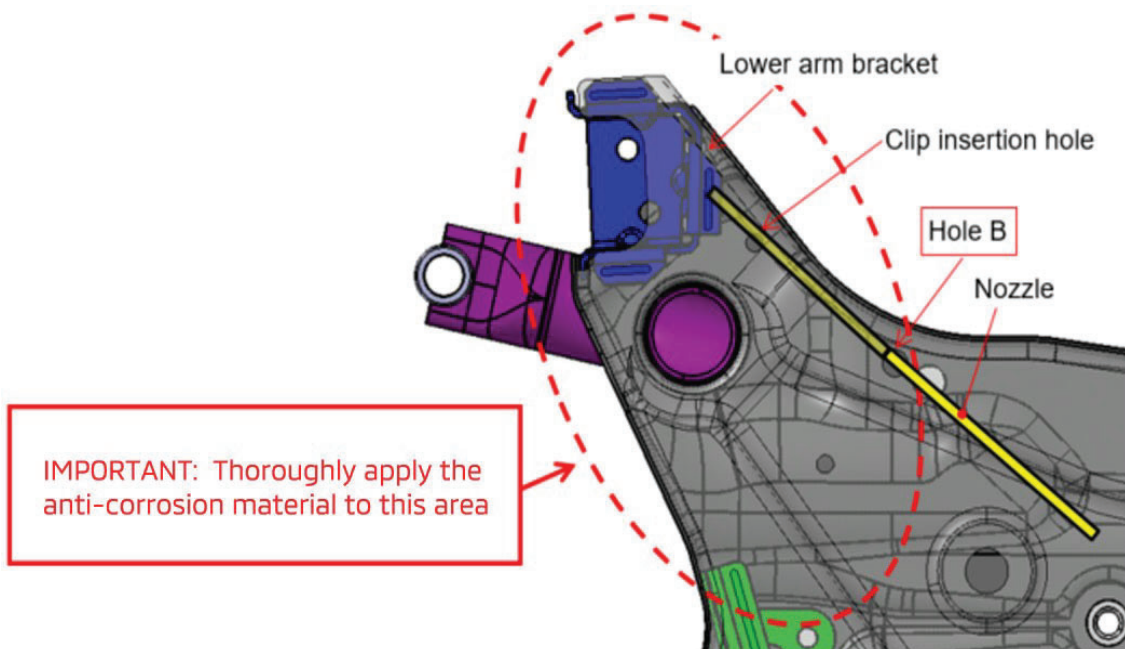

- c. Spraying into the Hole C (RH) / C' (LH) and D
 - Insert the nozzle through the Hole **C (C') or D** upwards (Insertion length: 25 mm or 1 inch).
 - Apply **MZ341024EX** fully by engaging the trigger fully and continue spraying while moving the nozzle in a circular motion for 10 seconds at each hole.

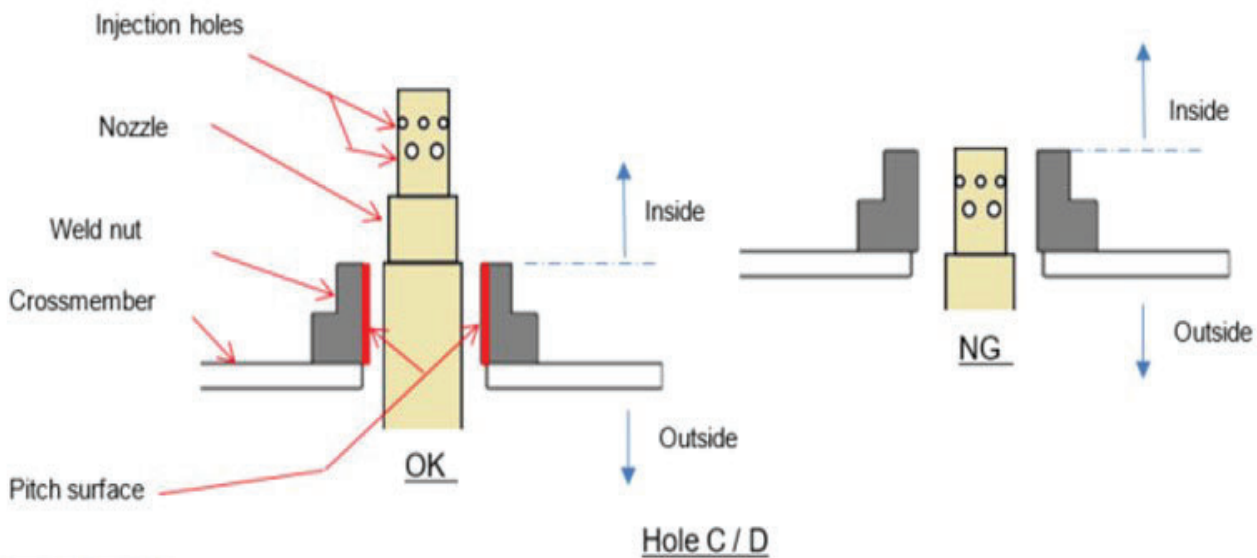

On Hole C and Hole D, insert nozzle until the nozzle is over weld nut. Make sure the anti-corrosion agent is not put on the inner surface of weld nut. Should anti-corrosion agent get on the inner surface of the weld nut; please remove by using a Universal Absorbent Pad.

When using the combination below:

Anti-Corrosion Agent	Spray Gun
MZ341024EX	T99XXKXX01
X	X

Nozzle should be inserted into the 9 holes identified:

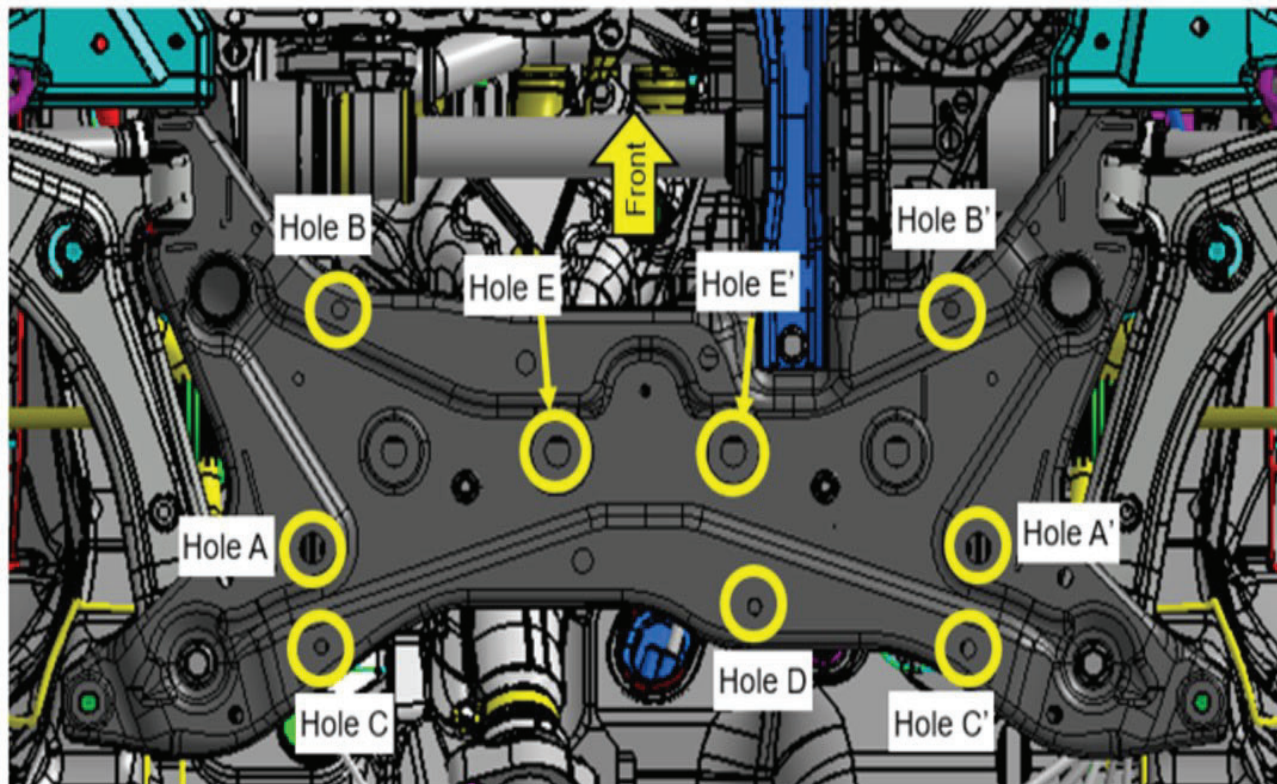

d. Spraying into the Hole A (RH) / A' (LH)

- Insert the nozzle through Hole **A(A')** in the direction shown below until it contacts the lower arm bracket (Insertion length: 180mm or 7 inches). Confirm that the nozzle has been fully inserted in the correct direction by looking in the opening of the lower arm bracket.
- Apply **MZ341024EX** by engaging the trigger fully at the position demonstrated below and confirm the **MZ341024EX** leaks out of the opening of the lower arm bracket. Continue spraying while removing the nozzle, which should take 10 seconds.

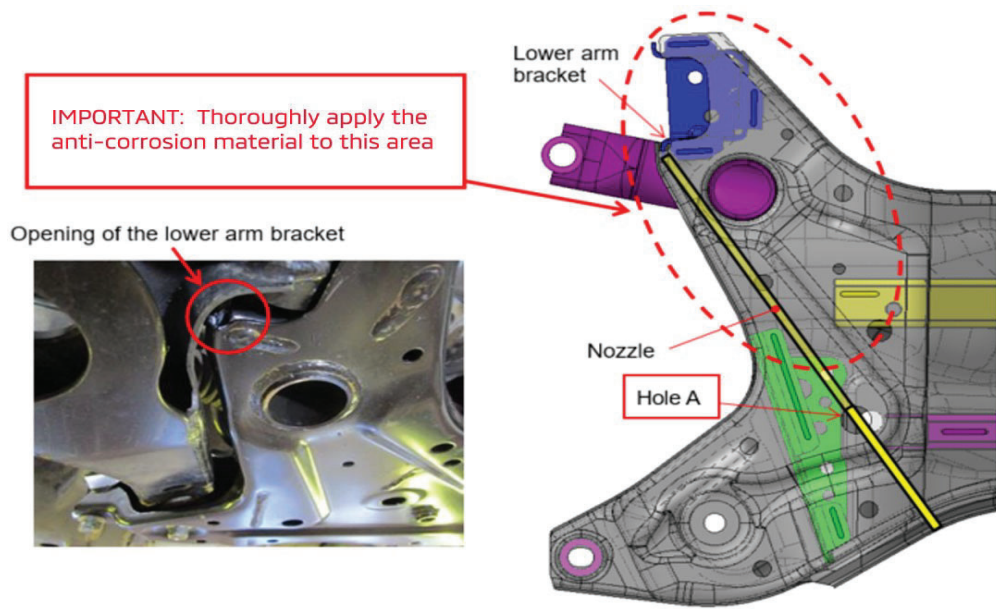

e. Spraying into the Hole A (RH) / A' (LH)

- Insert the nozzle through Hole **A(A')** in the direction shown below until it contacts the lower arm bracket (Insertion length: 70mm or 2.75 inches). Confirm that the nozzle has been fully inserted in the correct direction by looking in the opening of the lower arm bracket.
- Apply **MZ341024EX** by engaging the trigger fully at the position demonstrated below for 10 seconds and continue spraying while removing the nozzle, which should take 10 seconds.

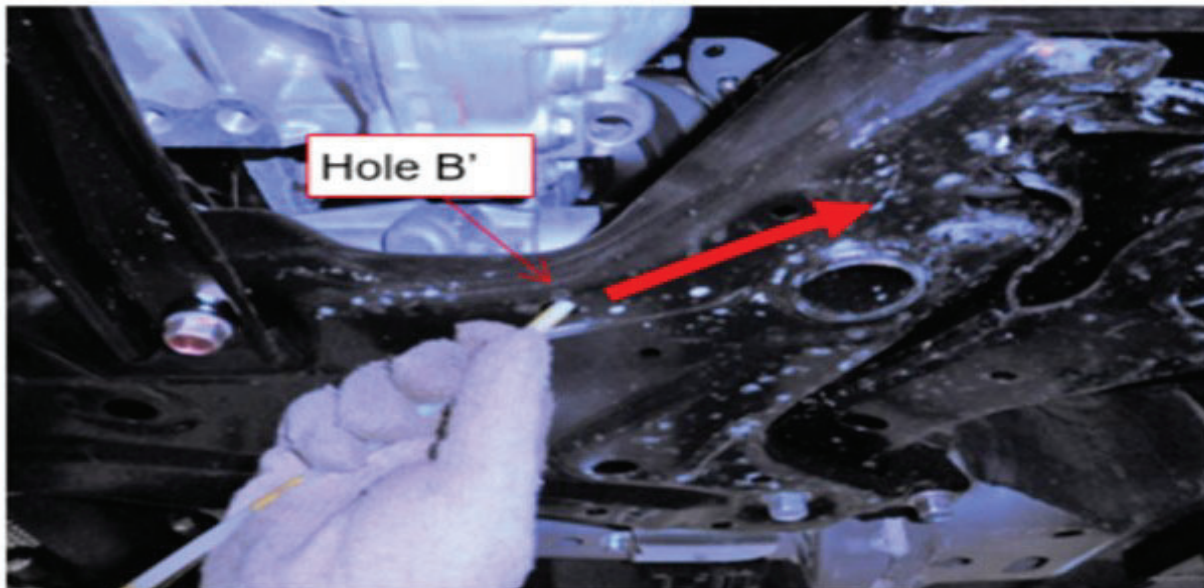
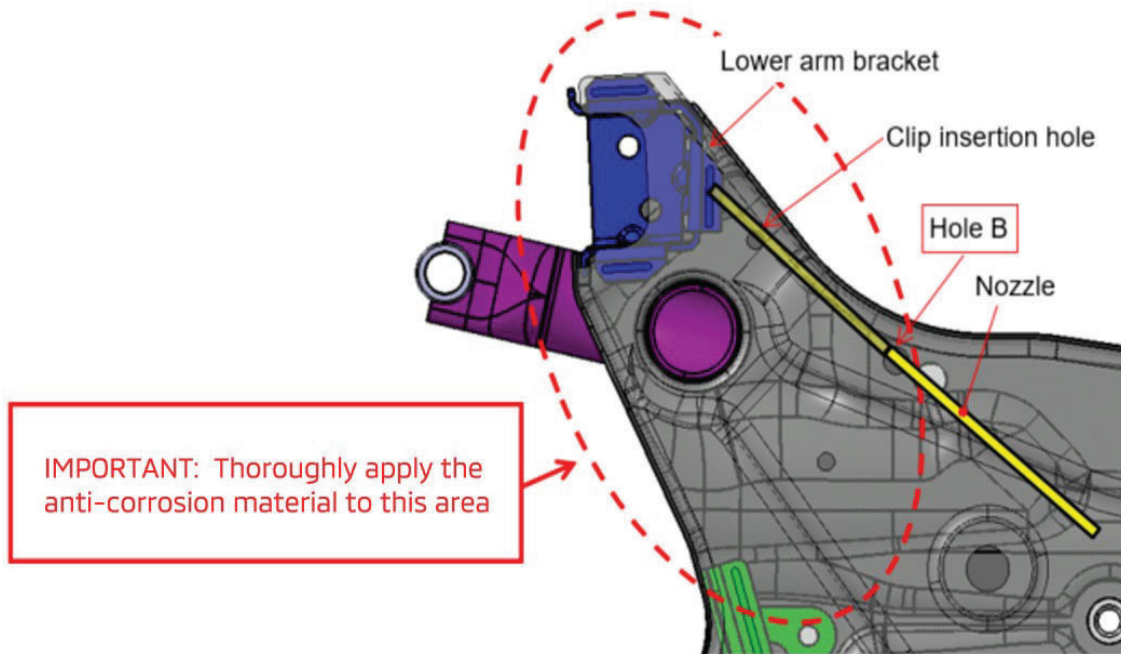

- f. Spraying into the Hole C (RH) / C' (LH) and D
- Insert the nozzle through the Hole **C (C') or D** upwards (Insertion length: 25 mm or 1 inch).
 - Apply **MZ321015** by engaging the trigger fully and spray for 10 seconds at this position.



CAUTION

On Hole C and Hole D, insert nozzle until the nozzle is over weld nut. Make sure the anti-corrosion agent is not put on the inner surface of weld nut. Should anti-corrosion agent get on the inner surface of the weld nut; please remove by using Universal Absorbent Pads.

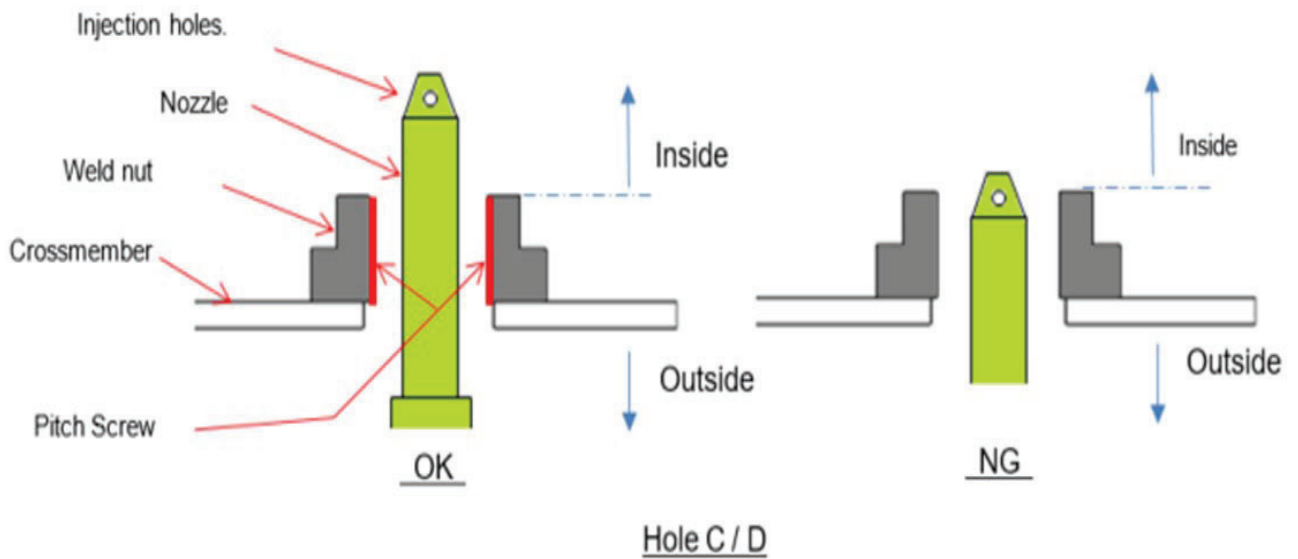

g. Spraying into the Hole E (RH) / E' (LH)

- Insert the nozzle through the Hole **E (E')** in the direction shown below (Insertion length: 180 mm or 7 inches).
- Apply **MZ341024EX** by engaging the trigger fully and spray for 10 seconds. Continue spraying while removing the nozzle, which should take 10 seconds.

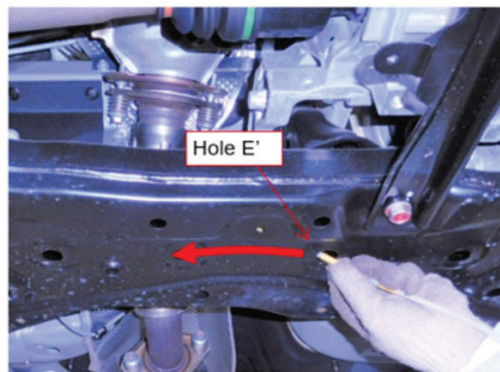
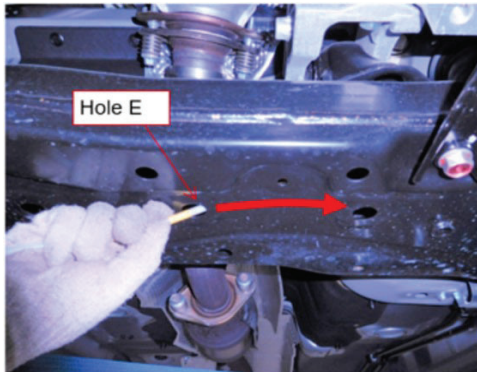
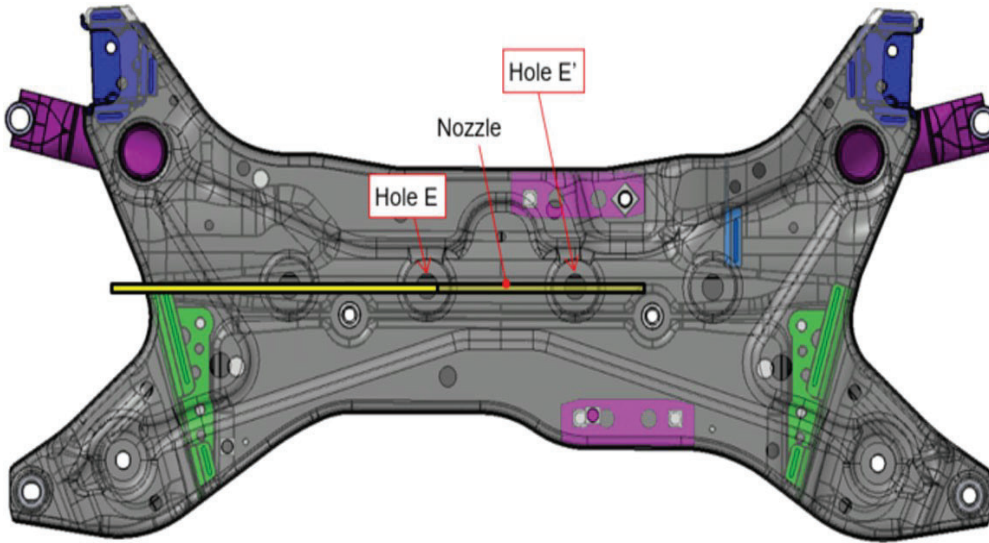

Application of anti-corrosion agent - MZ320800 - to the outside of the Crossmember.



Wear safety glasses, respirator, and gloves when spraying MZ320800.

1. Masking:
 - Mask rubber components such as suspension bushings, brake hoses, steering gear box boots/drive shaft boots, and exhaust pipe to prevent **MZ320800** from coming into contact with these components.
2. **MZ320800** external application:
 - Without detaching the Crossmember from the vehicle, apply **MZ320800** by positioning the nozzle 100 to 200 mm (or 4 to 8 inches) away from the Crossmember surface in the following order:
 - Step 1 Front surface
 - Step 2 Right surface
 - Step 3 Rear surface
 - Step 4 Left side surface
 - Step 5 bottom surface
 - Spray **MZ320800** by moving the nozzle at a constant speed of 0.2m/second (or 8inches/second). Spray it 2 to 3 times, repeatedly

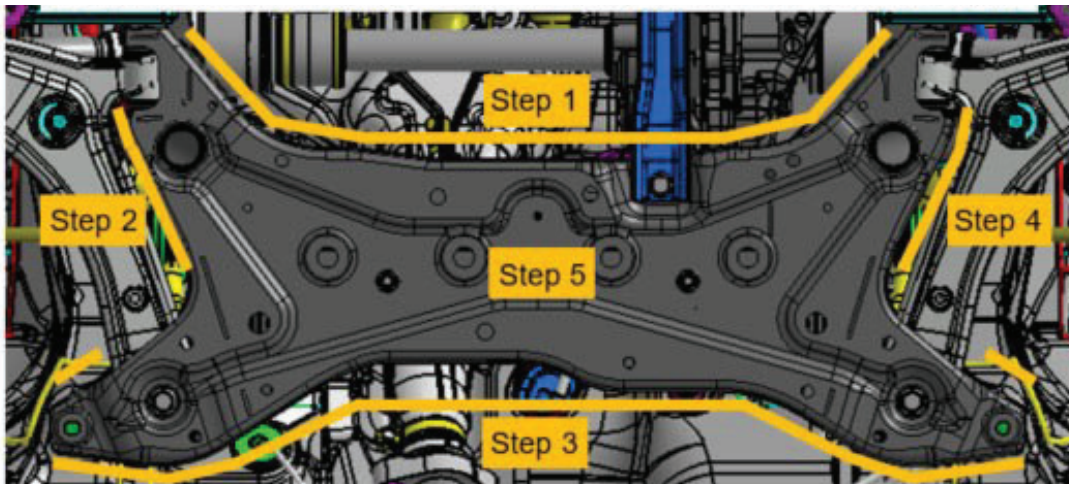

Wear safety glasses, respirator, and gloves when spraying MZ320800.

- a. Step 1 - Front surface:
 - Mask steering gear box boots, drive shaft boots and exhaust pipe.

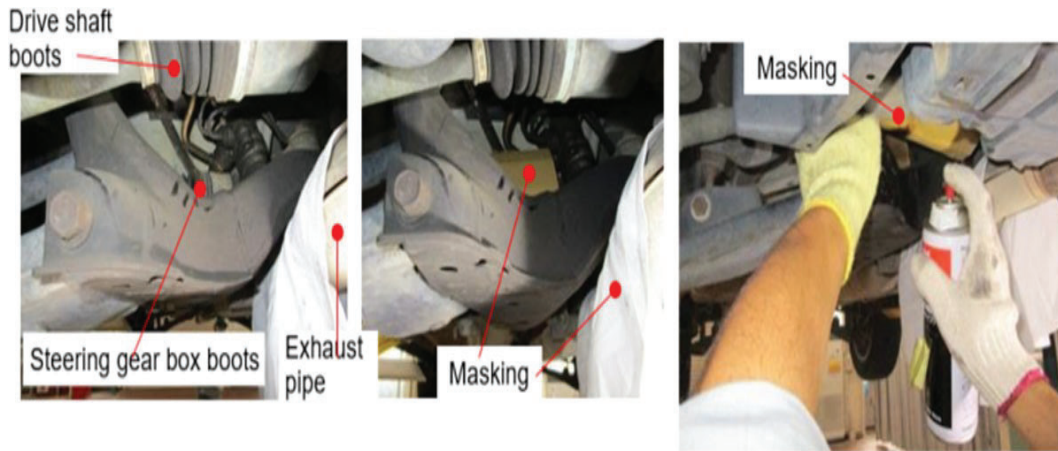

b. Step 2 - Right side surface / Step 4 - Left side surface:

- Mask suspension bushings, steering gear box boots, drive shaft boots, and brake hoses.

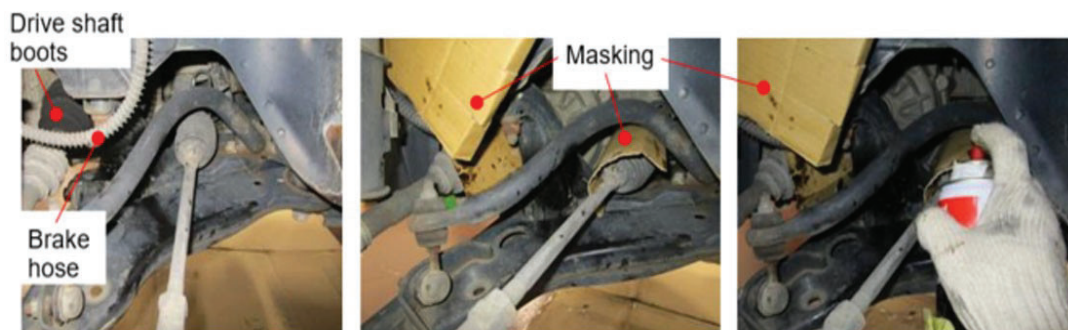

c. Step 3 - Rear surface / Step 5 bottom surface:



- Mask exhaust pipe.

PARTS INFORMATION

Use only the Genuine Mitsubishi Parts listed below:

Part Number	Part Description	Quantity/Vehicle	Comments
MZ341024EX	Anti-Corrosion Agent (Use with spray gun)	5 vehicles per bottle	For inside of the Crossmember
MZ320800	Anti-Corrosion Agent (Aerosol)	5 vehicles per can	For outside of the Crossmember
MW400273	Crossmember	1	For applicable replacement

NOTE: Additional spray gun or air regulators may be purchased at dealer's expense.

WARRANTY INFORMATION

- For instances where the sub-frame fails and causes additional damage to unrelated parts; PRC submission is required. Dealers should submit photos and make direct contact to the Warranty Hotline for resolution. ◀

Vehicles	Campaign Operation	Labor Time (hrs)	Repair Description
2013-2015 Outlander Sport	C2101R01	0.9	Inspection & Application of Anti-RustAgents
	C2101R02	2.5	Inspection & Replacement of Crossmember

WARRANTY / RECALL CAMPAIGN CLAIM INFORMATION

Enter all claims as claim type 'C' – Recall/Campaign Claims

Please follow the campaign instructions below.

Certain affected vehicles:

2013 – 2015 Outlander Sport*

NOTE: Always check the Superscreen to verify vehicle involvement.

A claim *example for reference:*

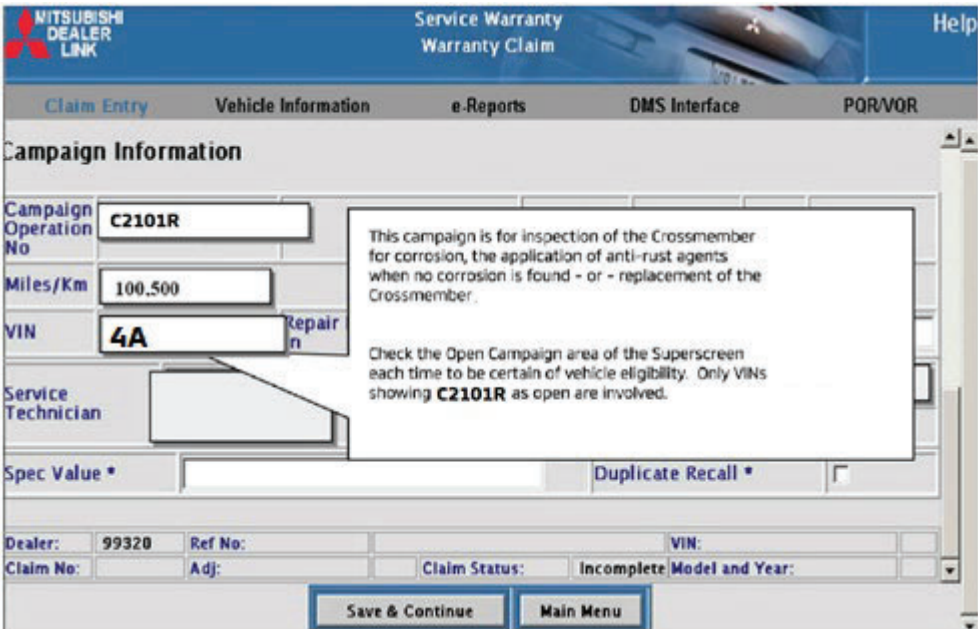

LABOR AND PARTS

There are only 2 possible repair scenarios for this campaign.

Scenario 1

Inspect = OK - then, still must apply the 2 anti-rust agents only.

Scenario 2

Inspect = applicable corrosion - replace Crossmember. **Do not apply anti-rust agent.**

Each can of the anti-rust agents is enough to complete 5 vehicles. Thus, the dealer net price for each of the materials is priced at dealer net divided by 5 and will be reflected automatically when entering the parts costs on the related recall campaign claim. Dealers will receive markup based on the per vehicle material prices.

REPLACED PARTS

Replaced parts must be held for at least 10 days beyond the recall claim payment date unless requested to be returned to MMNA. Return requested parts as you would any return requested warranty replaced part.

RENTAL CARS

If there is a need to provide the owner with a rental car or to claim return freight charges, claim the applicable charges in this section of the claim on the lower portion of the labor entry screen.

Select	Labor Operation	Labor Operation Description		Amount
<input type="checkbox"/>	SHO	SPECIAL HANDLING ORDER	SHO Parts Order	
<input type="checkbox"/>	RENTACAR	RENTAL CAR CHARGES	Days Reason <small><Select one></small> Rental Company Invoice Number	
<input type="checkbox"/>	95300040	FREIGHT CHARGES	Freight Company Invoice Number	
<input type="checkbox"/>	95200040	TOWING CHARGES	Towing Company Invoice Number	



IMPORTANT SAFETY RECALL

Mitsubishi Motors North America, Inc.

PO Box 689040
Franklin, TN 37068
Telephone: 888-648-7820
www.mitsubishicars.com

This notice applies to your vehicle, _____.

Date: March, 2021

Dear FIRSTNAME LASTNAME,

This notice is sent to you in accordance with the National Traffic and Motor Vehicle Safety Act.

Reason for notice: Mitsubishi Motors North America, Inc. (MMNA) has determined that a defect relating to motor vehicle safety exists in certain 2013 – 2015 Outlander Sport vehicles operated in states where road salt is used. The inside and outside surfaces of the front cross members used on certain vehicles, if exposed long term to snow melt water and anti-freezing agents, may corrode due to insufficient performance of the rust protection agent. If this occurs, the front lower control arms may detach. A detached front control arm can result in a loss of vehicle control, increasing the risk of a crash.

What you should do: Please contact your local Authorized Mitsubishi Motors dealer and schedule an appointment to have the repair performed. When you bring your vehicle in, please show the dealer this letter. If you misplace this letter, the dealer will still perform this repair for your vehicle, free of charge.

What your dealer will do: The dealer will inspect and apply anti-corrosion agents to the inside and outside of your vehicle's cross member. If perforation(s) are found during inspection, the dealer will replace your vehicle's cross member with a new one.

How long will it take? The time needed for inspection and application of anti-corrosion agents is approximately **1.5** hrs. If perforation(s) are found during the inspection, the repair could take up to **4 hrs**. The dealer may need your vehicle for a longer period of time, but every effort will be made to minimize your inconvenience.

If you have any questions, please contact the Mitsubishi Customer Relations Department at **888-648-7820**. Hours: Monday through Friday 7 a.m. to 4 p.m. (Central Time)

If, after contacting Mitsubishi Customer Relations, you still have a problem getting this repair made within a reasonable time frame and/or without charge, you may submit a complaint to the Administrator, National Highway Traffic Safety Administration, 1200 New Jersey Avenue SE, Washington, D.C. 20590, or call the toll-free Vehicle Safety Hotline at 1-888-327-4236 (TTY: 1-800-424-9153) or go to <http://www.safercar.gov>.

If you have already encountered a problem with excessive cross member corrosion and had it repaired or replaced as a result of this specific condition and have paid for the repair, you may send your original repair order or invoice **and** original receipt/proof of payment to the following address for reimbursement consideration:

Mitsubishi Customer Relations Department, P. O. Box 689040 Franklin, TN 37068

If you are the lessor of this vehicle, please forward a copy of this notice to the lessee within ten days to comply with federal regulations.

We appreciate your prompt attention to this matter.

Sincerely,

Mitsubishi Motors North America, Inc.

C2101R