



# Preliminary Information

## PIT5509H Diagnostic Tip - Check and/or Service Trailer Brake System message DTC C1114

Product Investigation Review Required

Models

Brand:	Model:	Model Years:	VIN:		Engine:	Transmissions:
			from	to		
Cadillac	Escalade Models	2021 - 2022	All	All	All	All
Chevrolet	Colorado	2015 - 2022	All	All	All	All
Chevrolet	Silverado 1500	2014	All	All	All	All
Chevrolet	Silverado	2015 - 2022	All	All	All	All
Chevrolet	Suburban	2015 - 2022	All	All	All	All
Chevrolet	Tahoe	2015 - 2022	All	All	All	All
GMC	Canyon	2015 - 2022	All	All	All	All
GMC	Sierra 1500	2014	All	All	All	All
GMC	Sierra	2015 - 2022	All	All	All	All
GMC	Yukon Models	2015 - 2022	All	All	All	All

**With Integrated Trailer Brake Control (ITBC) system RPO JL1**

**Supersession Statement**

This PI was superseded to update the Recommendation and Models. Please discard PIT5509G.

**The following diagnosis might be helpful if the vehicle exhibits the symptom(s) described in this PI.**

Condition / Concern

Some customers may comment that when they have a trailer connected to the vehicle, they get a "Check Trailer Wiring" or "Service Trailer Brake System" message on the DIC. DTC C1114 could be set in the Chassis Control Module/Chassis Control Module Auxiliary/Brake System Control Module.

Diagnosing these concerns can be difficult because the issue could either be related to the truck or the trailer. This PI is to provide some additional diagnostic information for these three symptoms:

- Check Trailer Wiring message
- Check Trailer Wiring message with DTC C1114
- Service Trailer Brake System message with DTC C1114

Recommendations / Instructions

**General Information**

The trailer brake control system on the new body style trucks is compatible with two types of trailer brake systems: electromagnetic or electro-over hydraulic trailer brakes. The Chassis Control Module K38 (CCM), Chassis Control Module Auxiliary K38A or Brake System

Control Module K160 (BSCM) depending on the model year, must determine which type of brakes the trailer is equipped with so the system can output correctly for the trailer's brake system. Because the CCM/BSCM has to determine the type of trailer brake system that is being used, it can be sensitive to a variety of trailer wiring issues.

The Trailer Brake Power Control Module K133 continuously sends a test pulse out on the trailer control circuit 47, looking for a trailer that has been connected, and also to monitor for circuit faults. The way the test pulse reacts when a trailer is connected is how the CCM/BSCM determines which type of braking system the trailer is equipped with.

Even after the system detects the trailer, it will continue to send this test pulse on circuit 47, which now is monitoring both the truck and trailer circuitry. Circuit 47 continues to be monitored for any faults so the driver can be notified of any issues that may occur within the truck or trailer, as well as, to determine when the trailer is disconnected from the truck. If the CCM/BSCM detects an issue, it will either display a "Check Trailer Wiring" or "Service Trailer Brake System" message on the DIC. See DIC message/DIC below.

## Electro-over Hydraulic Trailer Brakes

Electro-over hydraulic brake systems have some unique characteristics and here are a couple examples:

- The electro-over hydraulic brake pump motor needs a minimum duty cycle of approximately 20-30% to turn on the pump motor. If the user gain is set too low, or if the driver lightly applies the brake pedal, the pump motor may not turn on. This is normal. Pressing the brake pedal harder will help alleviate this concern. Always make sure trailer brake gain has been adjusted according to the procedure shown in the owner's manual.
- If the system detects electric-over-hydraulic brakes, when applying the brake pedal at 0 mph (stopped) there will be no output from the truck's trailer brake system to the electro-over hydraulic pump motor. This is normal.

**NOTE: Certain Dexter Electric-over Hydraulic actuators (identified with TCV, TCB or CBH in the first (3) letters of the serial number), were not designed to be compatible with the integrated trailer brake diagnostics. The integrated trailer brake system will initially appear to function without issue; however, when the trailer brakes are applied, a "Check Trailer Wiring" message will appear in the Driver Information Center. Then, after multiple brake applies, a "Service Trailer Brakes" message will appear in the Driver Information Center, and trailer brakes will be disabled for the remainder of the ignition cycle. The integrated trailer brake control system will report diagnostic trouble code C1114. Dexter has released an Electric-over Hydraulic Compatibility Adapter (p/n K58-036-00), which can be installed on the trailer, to correct this issue.**

## Testing The Truck's Trailer Brake System

In many cases, trailer brake issues are the result of trailer wiring concerns and they are not related to the actual vehicle's wiring. Most trailers with these wiring issues do not have high standards in relation to wiring/connections/splices/routing practices (see examples in Step 3 below) when compared to similar automotive practices for wiring/connections/splices/routing. Because of this, the CCM/BSCM can set faults, which can be hard to determine if they are related to the truck or trailer. The easiest and fastest way to test the truck is to make a tester using trailer brake magnets. This type of tester utilizes actual trailer brake magnets and will load the truck's electrical system, just like a trailer would do without having to have the complete trailer. Shown below is an examples of such a tester. The trailer brake system will operate with 1 to 4 pairs of trailer brake magnets (1 pair of magnets = 1 axle). It is suggested to make a tester where the pairs of magnets can be added or removed to equal the same number of brakes as the customer's trailer. Also, it is advised to make the harness long enough so it can be plugged into the truck's 7 way connector and have the magnets placed into the bed of the truck. When the tester is connected to the truck, the DIC will display "Trailer Connected" and GDS2 will show "Electromagnetic" brakes in the CCM/BSCM data parameter "Trailer Brake Type", refer to item 1 in "GDS2 Data" section below . If so, the vehicle can be driven to see if any fault messages or DTC's set. If none occur with the tester installed, the truck is operating correctly and the focus should be on the trailer wiring or 7 way connector.

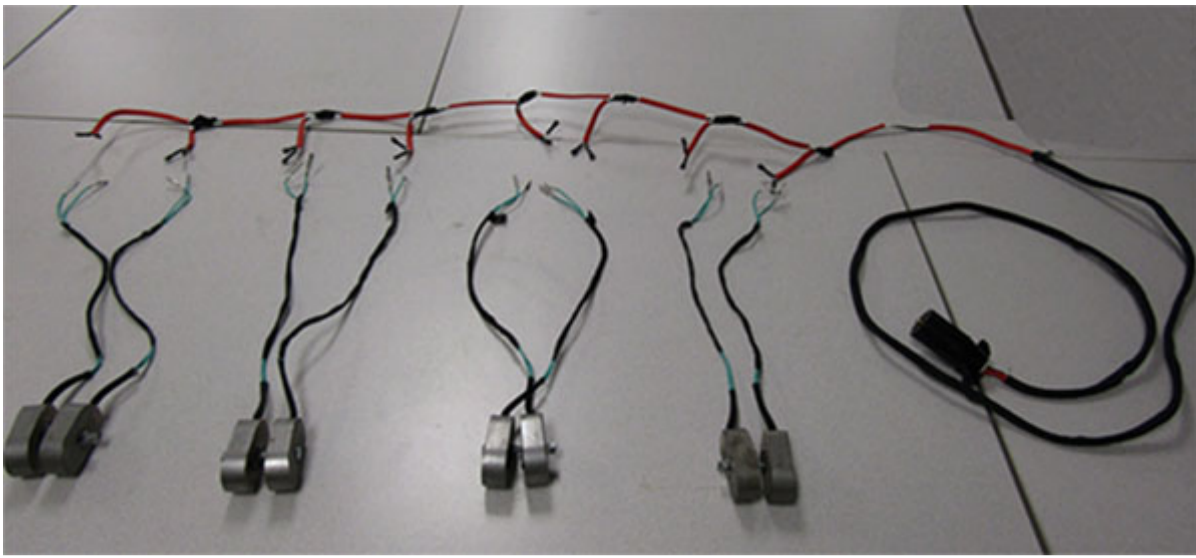

## Making the Tester

Parts needed:

1. 7 way RV trailer connector (example: Pollak Heavy Duty 7-Way Part # 12-706) Qty: 1
2. Electric Trailer Brake Magnets (example: Dexter Axle Part # K71-104-00) Qty: 2, 4, 6, or 8
3. 12 gauge wire and terminals/connectors Qty: as needed

Connect two 12 gauge wires to the 7-way RV trailer connector: one to the "Ground" terminal and a second to the "Brake Controller Output" terminal (circuit 47), shown below. Connect the other ends of the 12 gauge wires to the trailer brake magnets. All magnets must be connected in parallel so each magnet wire is connected to the Ground and Brake Controller Output wires from the 7 way connector.

**NOTE: Do NOT connect the magnets in series with each other.**

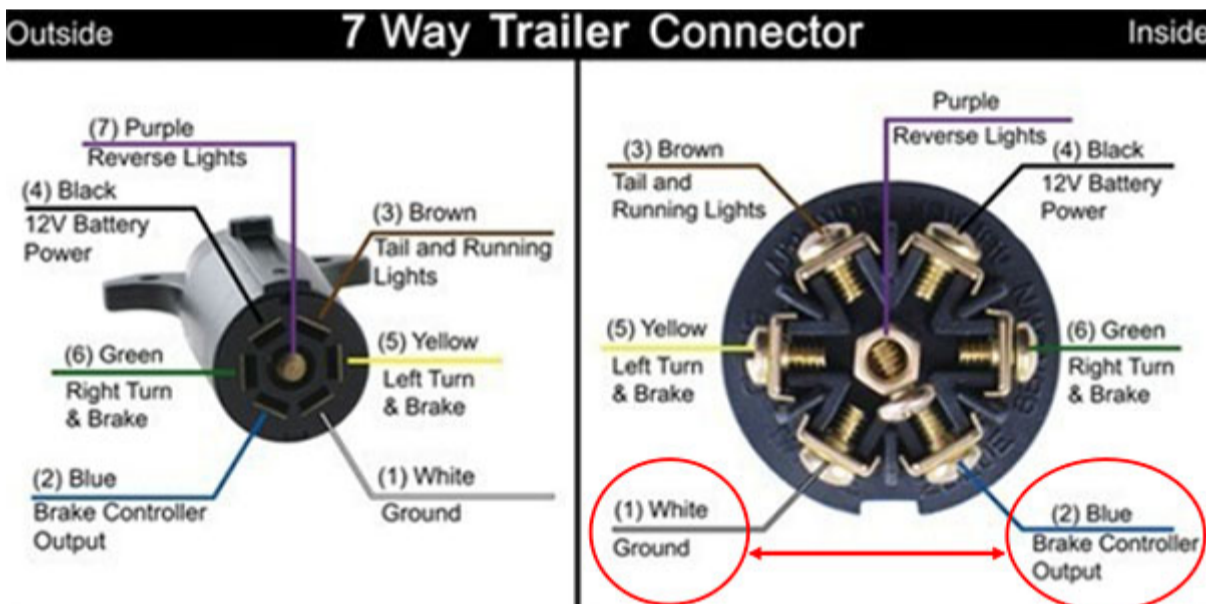

Example of a 2 axle trailer with electric trailer brakes

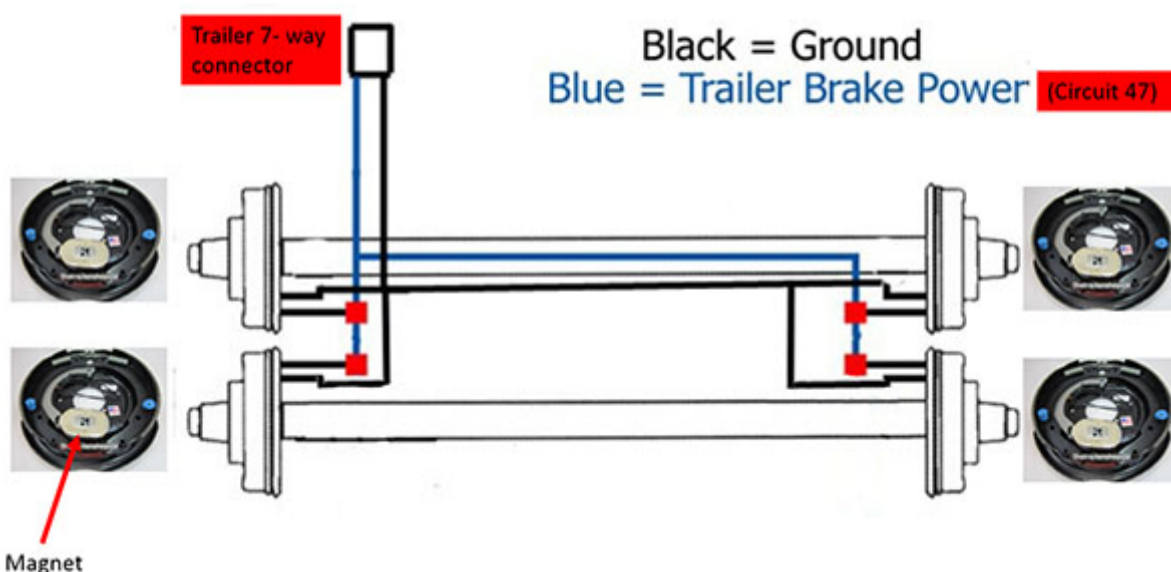

In addition to the tester shown above, GM has recently released a new trailer simulator tool, P/N EL-52641, shown below. When this tester is connected to the truck, the DIC will display "Trailer Connected" and GDS2 will show "Electro-Hydraulic" brakes in the CCM/BSCM data parameter "Trailer Brake Type". If so, the vehicle can be driven to see if any fault messages or DTC's set. If none occur with the tester installed, the truck is operating correctly and the focus should be on the trailer wiring or 7 way connector.



If, after using either of the two tester shown above and the truck functions properly, you may follow the diagnostic tips listed below to help diagnose a trailer related issue. Trailer issues are NOT covered under warranty, but this information listed below can be used to help the customer/trailer supplier understand and correct any trailer related issues if they so choose.

### DIC Message/ DTC's

It is important to understand and determine what message is being displayed, as well as, if DTC C1114 is setting. This will help determine what type of fault to inspect for on the trailer. Below is the combinations of message(s)/DTC to determine the type of fault the customer is experiencing:

- Check Trailer Wiring message with no DTC. This symptom is caused after the system detects a trailer and an open and/or high resistance occurs in circuit 47/trailer brake output circuit, during the same ignition cycle.  
**NOTE: It is normal for the DIC to display "Check Trailer Wiring" when the trailer is disconnected from the truck while the ignition is in the run position.**
- Check Trailer Wiring message with DTC C1114 (NO Service Trailer Brake message). This symptom is caused by a short to ground on circuit 47.
- Service Trailer Brake System with DTC C1114. This symptom is caused by a short to power on circuit 47 or a poor trailer ground.

### GDS2 Data

GDS2 (scan tool) can be used to view several different data parameters in the CCM/BSCM for the trailer brake system. The Trailer Brake Type and Trailer Brake Control Output Circuit parameters listed below can be helpful to make sure the CCM/BSCM is detecting the correct trailer brake system in addition to which type of fault it has detected.

To view "Trailer Brake Type" build GDS2 as follows: CCM/BSCM->Data Display -> parameter "Trailer Brake Type": "Electro-magnetic", "Electro-over hydraulic brakes", or "Undefined" (this is displayed with no trailer connected). Example, shown below is a trailer equipped with electromagnetic trailer brakes.

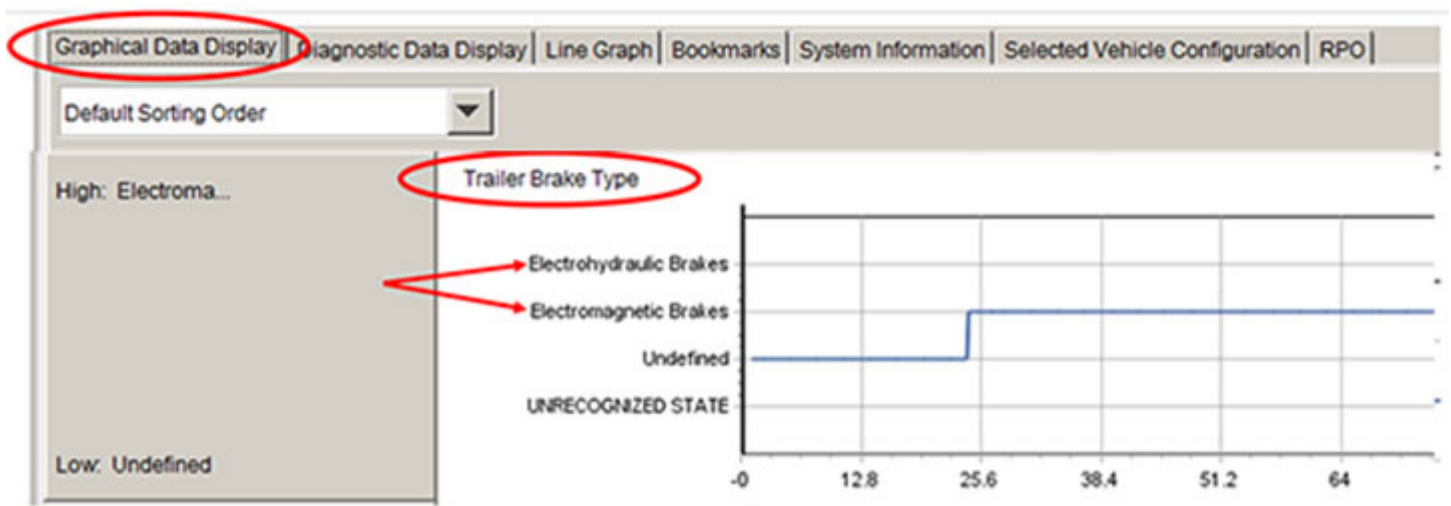

To view "Trailer Brake Control Output Circuit" 47 faults, build GDS2 as follows: CCM/BSCM->Data Display -> parameter "Trailer Brake Control Output Circuit": Okay, Short to Ground, Short to Power, or Unknown. Example, shown below is a trailer with a short to ground on the trailer brake circuit.

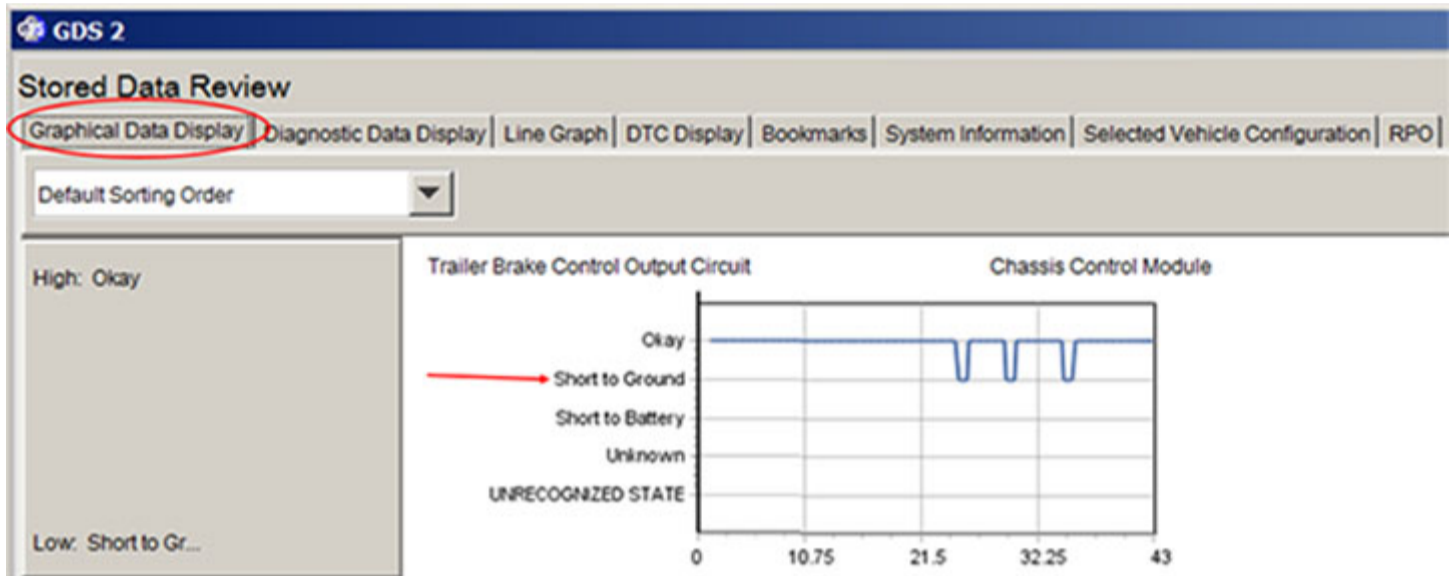

### 1. Trailer Brake Type Parameter

When the trailer is connected, this parameter should be used to make sure the CCM/BSCM has detected the correct type of trailer brakes. If the CCM/BSCM is detecting the wrong type of trailer brakes, here are several examples that could cause this:

- Refer to the "Trailer Issues" section below items 4 and/or 5.
- A trailer equipped with electromagnetic brakes on only one axle (meaning there is only one pair of magnets) could have a fault with one of the two magnets causing the CCM/BSCM to detect the wrong trailer brake type.

### 2. Trailer Brake Control Output Circuit Parameter

When the trailer is connected, this parameter can be used to help determine what type of fault the system has detected on circuit 47, which could lie within the truck or trailer.

## Sample Wiring Diagram

Below is an example of the truck's trailer brake system with the two main circuits that interface with the trailer brake system circled.

**NOTE: As always, use SI to look up the latest wiring diagrams for the vehicle being worked on.**

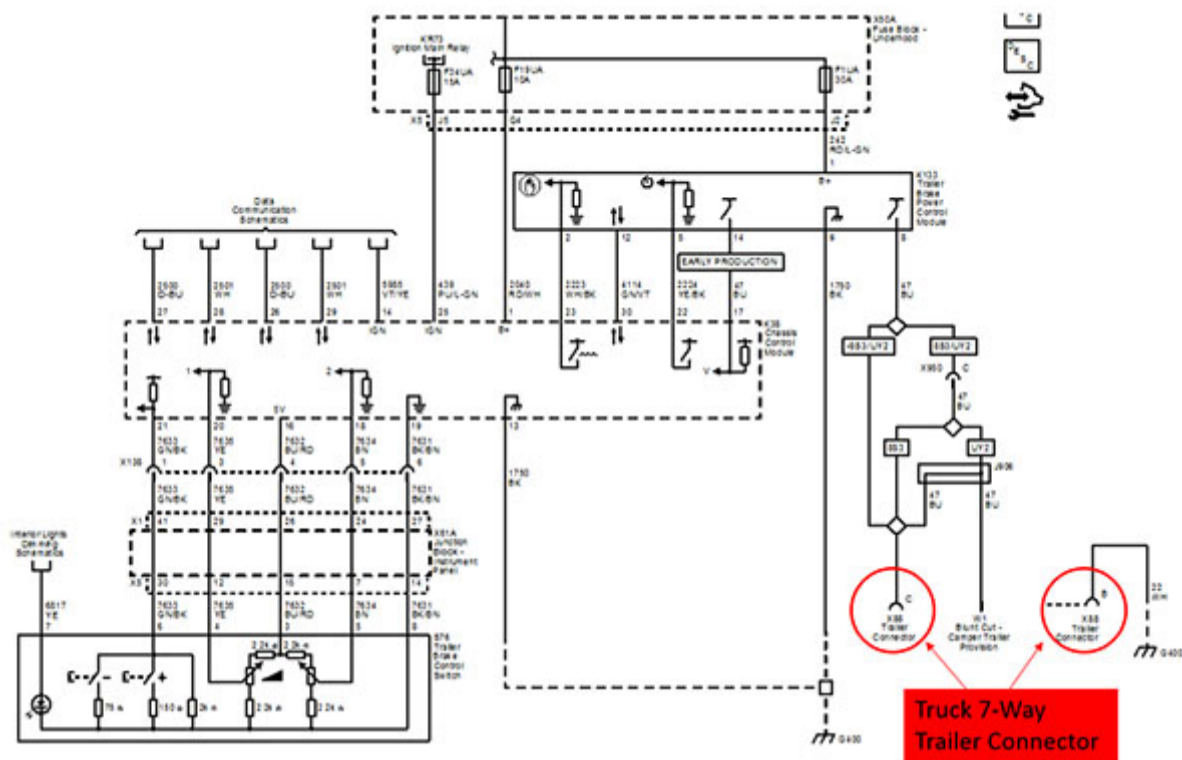

## Trailer Issues

1. The most likely reason for many of these issues is a poor/loose connection between the truck and trailer 7-way connector.

- It is recommended to use a "Pollak HD" RV trailer connector, as shown in the latest version of [PIT5311](#). Pollak is the OEM manufacturer of the truck's 7-way connector. By using a Pollak trailer connector, this will provide the best connection possible.

- For Model Year 2014 to 2018 ONLY -Engineering has released an updated truck-side trailer connector that incorporates a stronger door/cover spring. This helps to ensure a secure connection between the trailer connector and the truck connector. If the trailer connector is not being retained securely, replace the truck-side trailer connector with the updated GM part number 23404450, which has the stronger door/cover spring.

2. Shown below is an example of a 5th wheel trailer where the trailer harness has been routed over the top of the tailgate and plugged into the truck's bumper connector. While driving down the road, the trailer's wiring harness will bounce up and down (A), causing the trailer's 7-way connector to lose connection (B) with the truck. The fix in this case was to add the 5th wheel/camper wiring harness and route the 7-way connector's harness inside the box of the truck, as shown (C).

Note: This same concern can also happen with bumper pull trailers if there is an excessive length of harness. Securing the excessive trailer harness and installing the Pollak HD RV trailer connector per [PIT5311](#) will help.



3. Poor trailer wiring connections, as shown below. General Motors does not recommend these type of connections, but many trailers utilize these connections. These type of connections are not robust and are not recommended, especially for brake wiring.



4. Trailer electronic sway control devices. Some trailers may be equipped with electronic sway control devices, like the example shown below. These devices can apply the trailer's brakes to control trailer sway. These trailer mounted devices could potentially interfere with the functionality of the factory trailer brake controller resulting in reduced trailer brake performance, or even loss of trailer brakes. Depending on the brand of the sway control device, the following behaviors might be observed:

In some cases, when the trailer mounted sway module activates, it could cause the vehicle to set DTC C1114, and display the "Service Trailer Brake System" message on the DIC. This could be an indication that the trailer brakes are no longer functioning.

In other cases, when the trailer mounted sway module activates, the vehicle could display the "trailer disconnected" message, indicating that trailer brakes are no longer available. Then, when the sway module ceases to activate, the "trailer detected" message might be displayed which could indicate that the trailer brakes were available again.

Some trailer mounted sway control devices could also affect the vehicle's ability to correctly differentiate between electric or electric/hydraulic trailer brakes.

Before towing a trailer equipped with an electronic sway control device, the customer should contact the device's manufacturer to be sure it is compatible with the GM vehicle.

**NOTE:** If a trailer sways this is likely caused by improper loading of the trailer, refer to the owners manual for more information.

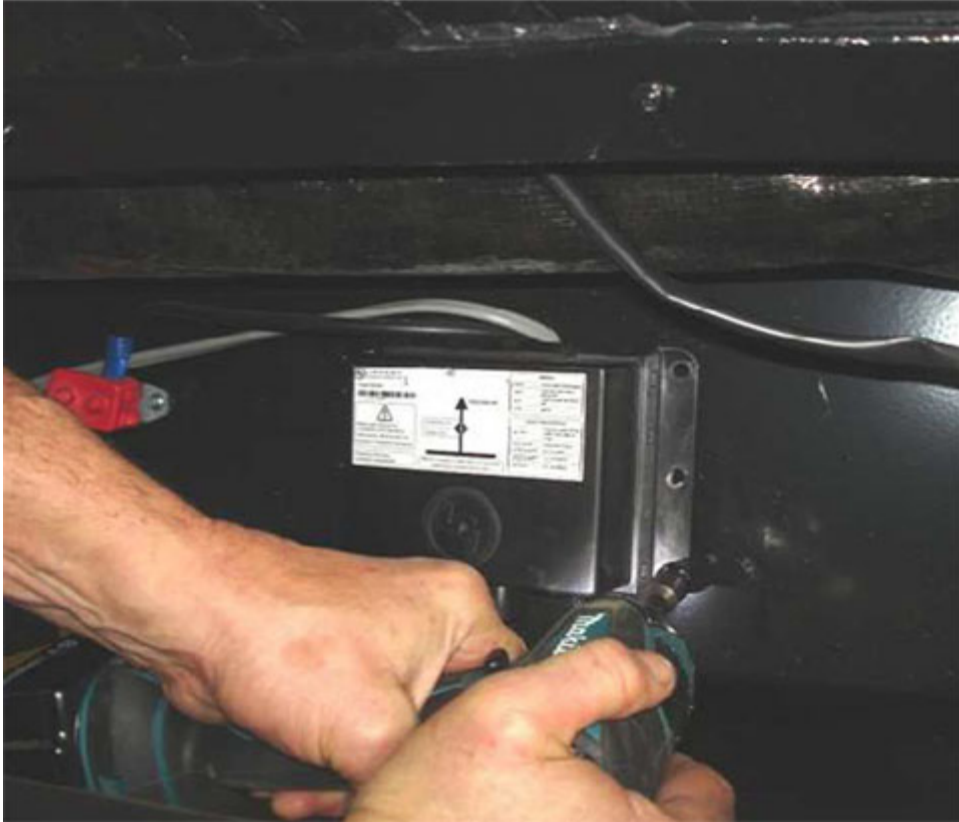

5. The CCM/BSCM is detecting the wrong type of trailer brakes. This is normally caused by an aftermarket device wired into the trailer. The example shown below is an electric over hydraulic-to-electric brake adapter. These adapters are used to make a truck that only works with electric trailer brakes work with a trailer that has electric over hydraulic brakes.



#### Parts Information

Part Number	Description	Qty
23404450	Truck 7-way Trailer Connector Socket (ONLY 2014-2018 Model Years)	1

#### Warranty Information

For vehicles repaired under the Bumper-to-Bumper coverage (Canada Base Warranty coverage), use the following labor operation. Reference the Applicable Warranties section of Investigate Vehicle History (IVH) for coverage information.



Labor Operation	Description	Labor Time
2460100	Wiring Harness Connector Replacement - Trailer Brake	Use Published Labor Operation Time

Please follow this diagnostic or repair process thoroughly and complete each step. If the condition exhibited is resolved without completing every step, the remaining steps do not need to be performed.



GENERAL MOTORS

© 2021 General Motors. All Rights Reserved.