



Wayne E. Bahr, Global Director
Automotive Safety Office
Sustainability, Environment & Safety Engineering

Fairlane Plaza South, Suite 400
330 Town Center Drive
Dearborn, MI 48126-2738

February 5, 2016

Mr. Greg Magno, Chief
Defects Assessment Division
Office of Defects Investigation
National Highway Traffic Safety Administration
1200 New Jersey Avenue SE/W48-334
Washington, DC 20590

Subject: 49 CFR Part 579.5 Monthly Communications – January 2016

Pursuant to the requirements set forth in Part 579 of Title 49 of the Code of Federal Regulations – Reporting of Information and Communications about Potential Defects, Ford Motor Company is submitting a Monthly Report for the period ending January 31, 2016.

The attachments contain representative copies of potentially responsive letters, notices, bulletins, and instructions that were made available to dealers in the United States via a Ford Motor Company website, or were sent to purchasers of our products in the United States, between the dates of January 1, 2016, and January 31, 2016.

Sincerely,

A handwritten signature in blue ink, appearing to read "Wayne E. Bahr".

for Wayne E. Bahr

Attachments

February 5, 2016
Attachment

**INDEX OF SERVICE BULLETINS,
NOTICES, AND COMMUNICATIONS TO DEALERS**

<u>NO.</u>	<u>DESCRIPTION</u>	<u>DATE</u>
1	Technical Service Bulletins	January 2016
2	Customer Satisfaction Program 15B23: Certain 2012-2014 Focus Electric Vehicles - High Voltage Wire Harness Update and Reprogram Powertrain Control Module	January 7, 2016
3	Customer Satisfaction Program 15M02: Certain 2011-2015 Model Year F-Super Duty Vehicles with 6.7L Diesel Engine - Exhaust Gas Temperature Sensor Extended Coverage	January 14, 2016
4	Customer Satisfaction Program 15B39: Certain 2015 Model Year Transit Vehicles - Under Hood Water Management Repair	January 21, 2016
5	Full Bulletin Customer Satisfaction Program 15N04: Certain 2015 Model Year MKC and MKZ Vehicles Equipped with the Reserve Equipment Group - Embedded Modem Replacement	January 27, 2016
6	Electronic Service Messages	January 2016

FORD:

2014-2016 Explorer

This article supersedes TSB **15-0113** to update the Service Procedure and Part List.

ISSUE

Some 2014-2016 Explorer vehicles equipped with second row inflatable seat belts may exhibit an air bag warning light illuminated with DTC B141B and/or B141C.

ACTION

Follow the Service Procedure steps to correct the condition.

SERVICE PROCEDURE

1. Disconnect the battery. Refer to Workshop Manual (WSM), Section 414-01.
2. Fold both of the second row seats forward to gain access to connectors C3133 and C3134.
3. Remove the seat bottom covers from both sides. Refer to WSM, Section 501-10.
4. On the left and right side, disconnect the connectors and remove the connector and wiring harness pushpin from its mounting on the seat frames.
5. On both sides, follow the seat harness and locate the next harness retaining pushpin and remove it from its mounting position to allow for more harness movement. Cut and discard the protruding end of the pushpin. (Figure 1)

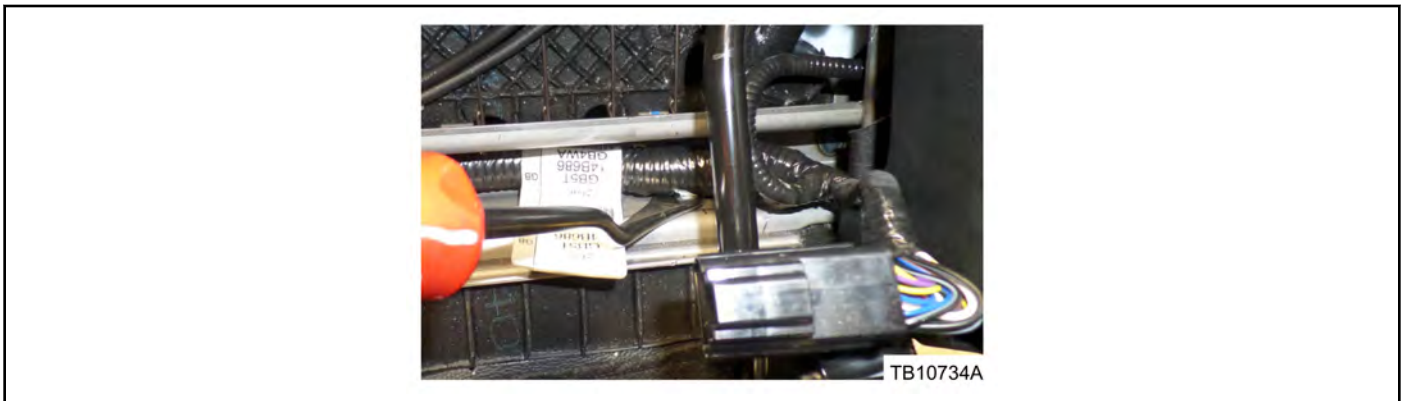

Figure 1 - Article 16-0001

6. On the male side of both connectors where the wiring harness is taped to the harness pushpin retainers, remove the retaining tape and the harness pushpin. Discard the pushpin. (Figure 2)

NOTE: The information contained in Technical Service Bulletins is intended for use by trained, professional technicians with the knowledge, tools, and equipment to do the job properly and safely. It informs these technicians of conditions that may occur on some vehicles, or provides information that could assist in proper vehicle service. The procedures should not be performed by "do-it-yourselfers". Do not assume that a condition described affects your car or truck. Contact a Ford, Lincoln, or Mercury dealership to determine whether the bulletin applies to your vehicle. Warranty Policy and Extended Service Plan documentation determine Warranty and/or Extended Service Plan coverage unless stated otherwise in the TSB article. The information in this Technical Service Bulletin (TSB) was current at the time of printing. Ford Motor Company reserves the right to supersede this information with updates. The most recent information is available through Ford Motor Company's on-line technical resources.

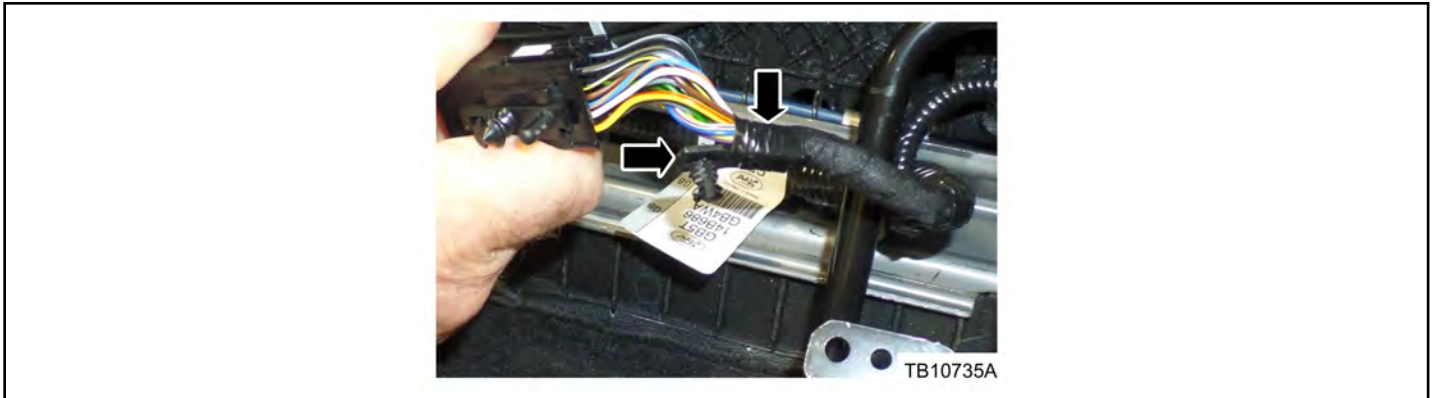

Figure 2 - Article 16-0001

7. Determine the vehicle's second row seat configuration.
 - a. If the vehicle is equipped with the 60/40 seats proceed to Step 8.
 - b. If the vehicle is equipped with second row armrest chairs proceed to Step 9.
8. For vehicles with 60/40 seats, perform the following procedure:
 - a. On the driver side cut the wires on the female side of C3133 and replace them with the new wiring pigtail. Only replace the length of wire removed from the harness. Solder the new wire to the existing circuits. Refer to Section 5 of the Wiring Diagram for the solder-splicing method.
 - b. On the male connector create a 15-20 mm (1/2-3/4") loop with the wiring harness and secure the harness to the connector using electrical tape. Make sure the wire loop does not contact the seat trim. Wrap the harness and connectors 3 times to provide harness stress relief and to prevent damage to the connector terminals when the seat is folded forward. (Figure 3)

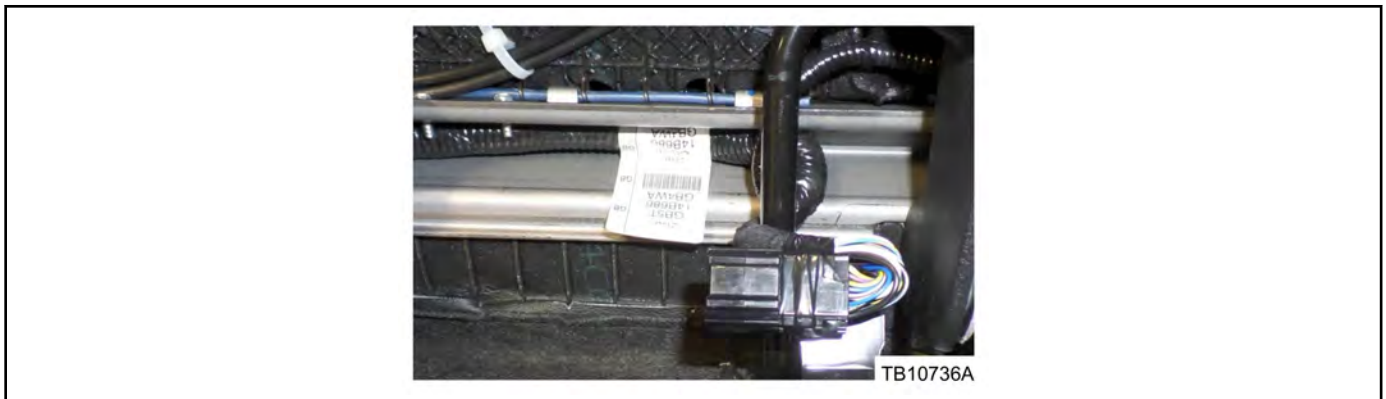

Figure 3 - Article 16-0001

- c. Reconnect the connector.
- d. Reattach the connector to the seat mounting with the existing pushpin.

TSB 16-0001 (Continued)

- e. On the passenger side, take the connector and route the seat harness to the other side of the black bar. (Figures 4 and 5)

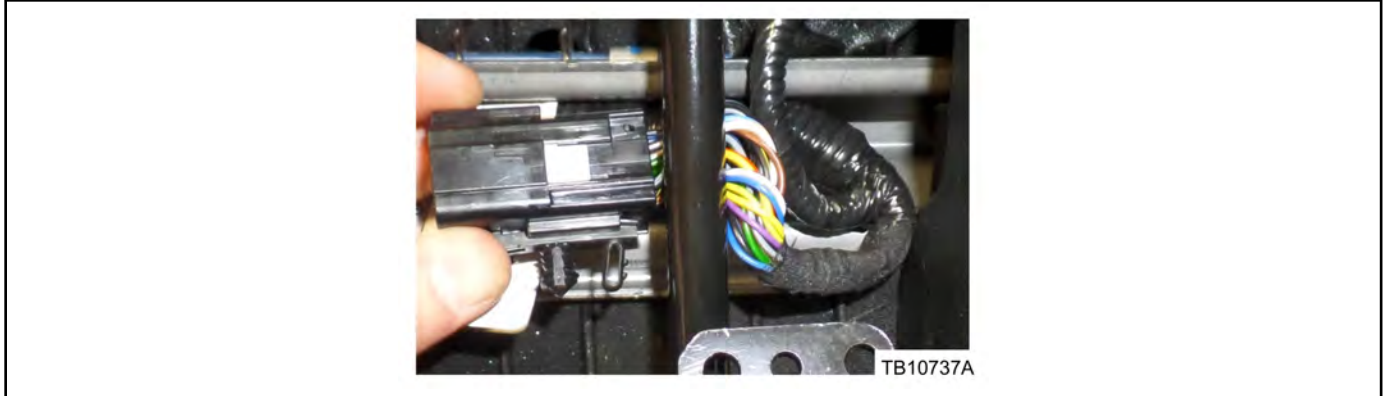

Figure 4 - Article 16-0001



Figure 5 - Article 16-0001

- f. Cut the wires for the female connector C3134 and replace them with the new wiring pigtail. Make sure to replace only the length of wire removed from the harness. Solder the new wire to the existing circuits. Refer to Section 5 of the Wiring Diagram for the solder-splicing method.
 - g. On the male connector create a 15-20 mm (1/2-3/4") loop with the wiring harness and secure the harness to the connector using electrical tape. Make sure the wire loop does not contact the seat trim. Wrap the harness and connectors 3 times around to provide harness stress relief and to prevent damage to the connector terminals when the seat is folded/tumbled forward. (Figure 3)
 - h. Reconnect the connector
 - i. Reattach the connector to the seat mounting with the existing pushpin and proceed to Step 10.
9. For vehicles with second row armrest chairs perform the following procedure:
 - a. On both the passenger and driver side seat take the connectors and route the seat harness to the other side of the black vertical bar. (Figures 4 and 5)
 - b. Cut the wires for both female connectors C3133 and C3134, and replace them with the new wiring pigtail. Only replace the length of wire removed from the harness. Solder the new wire to the existing circuits. Refer to Section 5 of the Wiring Diagram for the solder-splicing method.
 - c. On the male connector side, create a 15-20 mm (1/2-3/4") loop with the wiring harness and secure the harness to the connector using electrical tape. Make sure the wire loop does not contact the seat trim. Wrap the harness and connectors 3 times to provide harness stress relief and to prevent damage to the connector terminals when the seat is folded forward. (Figure 3)
 - d. Reconnect the connectors.

- e. Reattach both connectors to the seat mounting with the existing pushpins and proceed to Step 10.
- 10. Reattach the seat bottom cover. Refer to WSM, Section 501-10.
- 11. Reconnect the battery. Refer to WSM, Section 414-01

Obtain Locally
Electrical Tape

PART NUMBER	PART NAME
FU2Z-14S411-RA	Wiring Assembly (2 Req)

OPERATION	DESCRIPTION	TIME
160001A	2014-2016 Explorer: Perform Wiring Update Following The Service Procedure (Do Not Use With Any Other Labor Operations)	2.8 Hrs.

WARRANTY STATUS:

Eligible Under Provisions Of New Vehicle Limited Warranty Coverage
 Warranty/ESP coverage limits/policies/prior approvals are not altered by a TSB. Warranty/ESP coverage limits are determined by the identified causal part and verified using the OASIS part coverage tool.

DEALER CODING

BASIC PART NO.	CONDITION CODE
14A005	30

FORD:

2013-2014 Edge, Focus
 2013-2015 Explorer
 2013-2016 Escape, Fusion

LINCOLN:

2013-2016 MKZ
 2015-2016 MKC

This article supersedes TSB **15-0096** to update the vehicle model years.

ISSUE

Some 2013-2016 Escape, Fusion, MKZ, 2013-2015 Explorer, 2013-2014 Focus ST, Edge and 2015-2016 MKC vehicles equipped with 2.0L EcoBoost engines may exhibit fuel odor originating from the positive crankcase ventilation (PCV) hose.

ACTION

Follow the Service Procedure steps to correct the condition.

SERVICE PROCEDURE

1. Inspect the PCV hose to make sure it is properly connected to the valve cover and the low pressure intake duct.
 - a. For Escape and Focus ST vehicles remove the cowl panel grille to access the hose. Refer to Workshop Manual (WSM), Section 501-02.
 - b. For Edge vehicles remove the air cleaner outlet pipe to access the hose. Refer to WSM, Section 303-12.
2. Does the PCV hose exhibit a fuel smell or was the hose disconnected?
 - a. Yes - replace the PCV hose assembly and reassemble the vehicle.
 - b. No - Refer to WSM, Section 303-13 for normal diagnosis.

PART NUMBER	PART NAME
EJ7Z-6758-B	Positive Crankcase Ventilation Hose Assembly

OPERATION	DESCRIPTION	TIME
160002A	2013-2016 Escape, 2.0L EcoBoost: Inspect And Replace PCV Hose Includes Time To Remove And Install The Cowl Panel Grille (Do Not Use With Any Other Labor Operations)	0.5 Hr.
160002A	2013-2014 Focus ST, 2.0L EcoBoost: Inspect And Replace PCV Hose Includes Time To Remove And Install The Cowl Panel Grille (Do Not Use With Any Other Labor Operations)	0.4 Hr.
160002A	2013-2014 Edge 2.0L EcoBoost: Inspect And Replace PCV Hose Includes Time To Remove And Install The Air Cleaner Outlet Pipe (Do Not Use With Any Other Labor Operations)	0.3 Hr.

NOTE: The information contained in Technical Service Bulletins is intended for use by trained, professional technicians with the knowledge, tools, and equipment to do the job properly and safely. It informs these technicians of conditions that may occur on some vehicles, or provides information that could assist in proper vehicle service. The procedures should not be performed by "do-it-yourselfers". Do not assume that a condition described affects your car or truck. Contact a Ford, Lincoln, or Mercury dealership to determine whether the bulletin applies to your vehicle. Warranty Policy and Extended Service Plan documentation determine Warranty and/or Extended Service Plan coverage unless stated otherwise in the TSB article. The information in this Technical Service Bulletin (TSB) was current at the time of printing. Ford Motor Company reserves the right to supersede this information with updates. The most recent information is available through Ford Motor Company's on-line technical resources.

OPERATION	DESCRIPTION	TIME
160002A	2013-2015 Explorer, 2013-2016 Fusion, MKZ, 2015-2016 MKC 2.0L EcoBoost: Inspect And Replace PCV Hose (Do Not Use With Any Other Labor Operations)	0.2 Hr.

WARRANTY STATUS:

Eligible Under Provisions Of New Vehicle Limited Warranty Coverage And Emissions Warranty Coverage
 Warranty/ESP coverage limits/policies/prior approvals are not altered by a TSB. Warranty/ESP coverage limits are determined by the identified causal part and verified using the OASIS part coverage tool.

DEALER CODING

BASIC PART NO.	CONDITION CODE
6758	49

**3.5L GTDI - NO START AFTER USING BLOCK HEATER -
TEMPERATURES BELOW -15 °C (0 °F)****TSB 16-0003****FORD:**

2015-2016 Expedition, F-150

LINCOLN:

2015-2016 Navigator

ISSUE

Some 2015-2016 F-150, Expedition and Navigator vehicles equipped with 3.5L Gasoline Turbocharged Direct Injection (GTDI) engine may exhibit a hard to start or no start condition after using the block heater when temperatures are below -15 °Celsius (0 °Fahrenheit).

ACTION

Follow the Service Procedure steps to correct the condition.

SERVICE PROCEDURE

1. Is the vehicle equipped with a heater in the thermostat housing? Refer to Workshop Manual (WSM), Section 303-03.
 - a. Yes - proceed to Step 2.
 - b. No - this article does not apply. Refer to Powertrain Control/Emissions Diagnosis (PC/ED) manual for normal diagnosis.
2. Remove and discard the existing cooling system heater and wire harness.
3. Install the immersion block heater and harness kit. Refer to the instruction sheet included in the kit.
 - a. It is not necessary to remove the left hand turbocharger assembly.
 - b. Use special tool 303-1638 to install the immersion block heater.
4. Fill the cooling system. Refer to WSM, Section 303-03.

Recommend to the customer they plug the block heater in at temperatures at or below -15 °C (0 °F) to improve cold starting.

PART NUMBER	PART NAME
VC-3-B	Motorcraft® Orange Concentrated Antifreeze/Coolant
FL3Z-6D008-A	Immersion Block Heater Kit

OPERATION	DESCRIPTION	TIME
160003A	2015-2016 F-150 3.5L GTDI: Remove The Existing Cooling System Heater And Install Immersion Block Heater Following The Service Procedure (Do Not Use With Any Other Labor Operations)	1.2 Hrs.
160003A	2015-2016 Expedition And Navigator 3.5L GTDI: Remove The Existing Cooling System Heater And Install Immersion Block Heater Following The Service Procedure (Do Not Use With Any Other Labor Operations)	1.6 Hrs.

WARRANTY STATUS:

Eligible Under Provisions Of New Vehicle Limited Warranty Coverage

Warranty/ESP coverage limits/policies/prior approvals are not altered by a TSB. Warranty/ESP coverage limits are determined by the identified causal part and verified using the OASIS part coverage tool.

NOTE: The information contained in Technical Service Bulletins is intended for use by trained, professional technicians with the knowledge, tools, and equipment to do the job properly and safely. It informs these technicians of conditions that may occur on some vehicles, or provides information that could assist in proper vehicle service. The procedures should not be performed by "do-it-yourselfers". Do not assume that a condition described affects your car or truck. Contact a Ford, Lincoln, or Mercury dealership to determine whether the bulletin applies to your vehicle. Warranty Policy and Extended Service Plan documentation determine Warranty and/or Extended Service Plan coverage unless stated otherwise in the TSB article. The information in this Technical Service Bulletin (TSB) was current at the time of printing. Ford Motor Company reserves the right to supersede this information with updates. The most recent information is available through Ford Motor Company's on-line technical resources.

DEALER CODING

BASIC PART NO.	CONDITION CODE
6010	01

FORD:

2011-2016 F-Super Duty

This article supersedes TSB **14-0232** to update vehicle model years.

ISSUE

Some 2011-2016 F-Super Duty vehicles equipped with a 6.7L engine may exhibit a loss of power due to snow packing in or around the engine air cleaner (ACL) when operated in extreme snow conditions or when equipped with a snowplow. This concern may result in diagnostic trouble codes (DTCs) P0299 and P1247. A low restriction secondary foam filter is now available to resolve this concern.

ACTION

Follow the Service Procedure steps to correct the condition.

SERVICE PROCEDURE

1. Remove the ACL cover and element. Refer to Workshop Manual (WSM), Section 303-12.
2. Clear any snow and/or ice from the ACL housing inlet.
3. Remove and discard the foam ACL filter element.
4. Install the new low restriction secondary foam filter.
5. Install the ACL element, cover and reset the restriction gauge. Refer to WSM, Section 303-12.

PART NUMBER	PART NAME
BC3Z-9601-D	Secondary Foam Filter

OPERATION	DESCRIPTION	TIME
160004A	2011-2016 F-Super Duty 6.7L: Check DTCs And Replace The Secondary Foam Filter Includes Time To Clear DTCs (Do Not Use With Any Other Labor Operation)	0.4 Hr.

WARRANTY STATUS:

Eligible Under Provisions Of New Vehicle Limited Warranty Coverage And Emissions Warranty Coverage
Warranty/ESP coverage limits/policies/prior approvals are not altered by a TSB. Warranty/ESP coverage limits are determined by the identified causal part and verified using the OASIS part coverage tool.

DEALER CODING

BASIC PART NO.	CONDITION CODE
9601	55

NOTE: The information contained in Technical Service Bulletins is intended for use by trained, professional technicians with the knowledge, tools, and equipment to do the job properly and safely. It informs these technicians of conditions that may occur on some vehicles, or provides information that could assist in proper vehicle service. The procedures should not be performed by "do-it-yourselfers". Do not assume that a condition described affects your car or truck. Contact a Ford, Lincoln, or Mercury dealership to determine whether the bulletin applies to your vehicle. Warranty Policy and Extended Service Plan documentation determine Warranty and/or Extended Service Plan coverage unless stated otherwise in the TSB article. The information in this Technical Service Bulletin (TSB) was current at the time of printing. Ford Motor Company reserves the right to supersede this information with updates. The most recent information is available through Ford Motor Company's on-line technical resources.

FORD:

2015 F-150

This article supersedes TSB **15-0045** to add a production fix date, update the Service Procedure and Part List.

ISSUE

Some 2015 F-150 vehicles may have a glove compartment that does not latch properly.

ACTION

Follow the Service Procedure steps to correct this condition.

SERVICE PROCEDURE

1. Open the glove compartment and release the glove compartment down stops. Remove the dampener by pushing down and forward at the damper end then fully lower the glove compartment. Refer to Workshop Manual (WSM), Section 501-12.
2. Inspect both glove compartment hinge pins to make sure they are properly installed through the glove compartment hinge and supported at both ends by the instrument panel. (Figure 1)

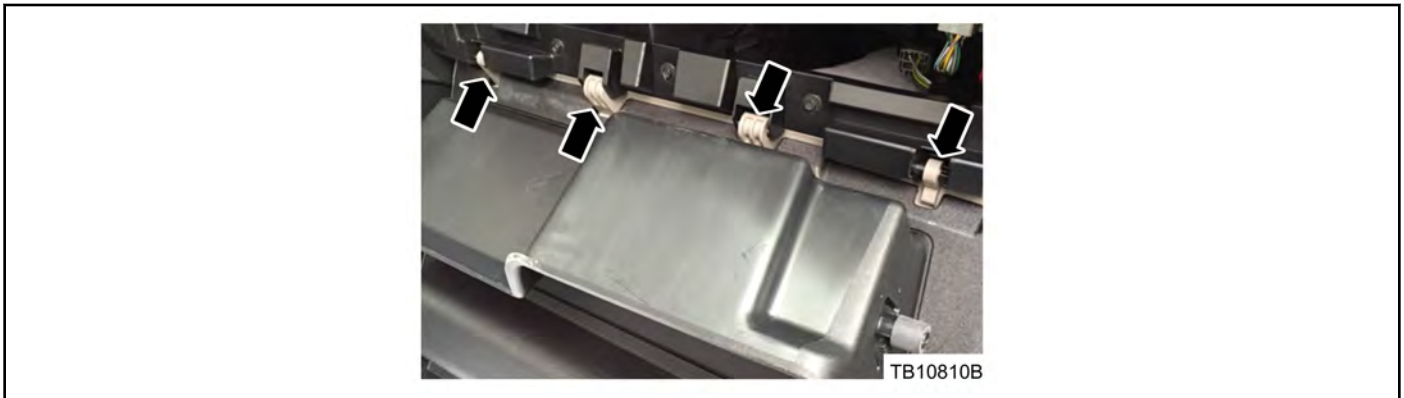

Figure 1 - Article 16-0005

3. Inspect the glove compartment center hooks to make sure they are properly attached to the hinge line of the instrument panel. (Figure 2)

NOTE: The information contained in Technical Service Bulletins is intended for use by trained, professional technicians with the knowledge, tools, and equipment to do the job properly and safely. It informs these technicians of conditions that may occur on some vehicles, or provides information that could assist in proper vehicle service. The procedures should not be performed by "do-it-yourselfers". Do not assume that a condition described affects your car or truck. Contact a Ford, Lincoln, or Mercury dealership to determine whether the bulletin applies to your vehicle. Warranty Policy and Extended Service Plan documentation determine Warranty and/or Extended Service Plan coverage unless stated otherwise in the TSB article. The information in this Technical Service Bulletin (TSB) was current at the time of printing. Ford Motor Company reserves the right to supersede this information with updates. The most recent information is available through Ford Motor Company's on-line technical resources.



Figure 2 - Article 16-0005

4. Are the hinge pins and center hooks properly attached?
 - a. Yes - proceed to Step 7.
 - b. No - proceed to Step 5.
5. If the glove compartment hinge pins or hooks are not properly installed, remove the glove compartment hinge pins and the glove compartment. Refer to WSM, Section 501-12.
6. Reattach the glove compartment by attaching only the center two hooks first, then installing the two hinge pins.
 - a. Do not reattach the dampener or latch the down stops until this article is completed.
7. Remove the left and right glove compartment strikers. (Figure 2)
 - a. Reach inside the glove compartment opening of the instrument panel, behind the long vertical side of each striker and press them out by hand. (Figure 3)



Figure 3 - Article 16-0005

8. Remove by hand the 2 (two) rubber bumpers from the glove compartment. (Figure 4)

TSB 16-0005 (Continued)

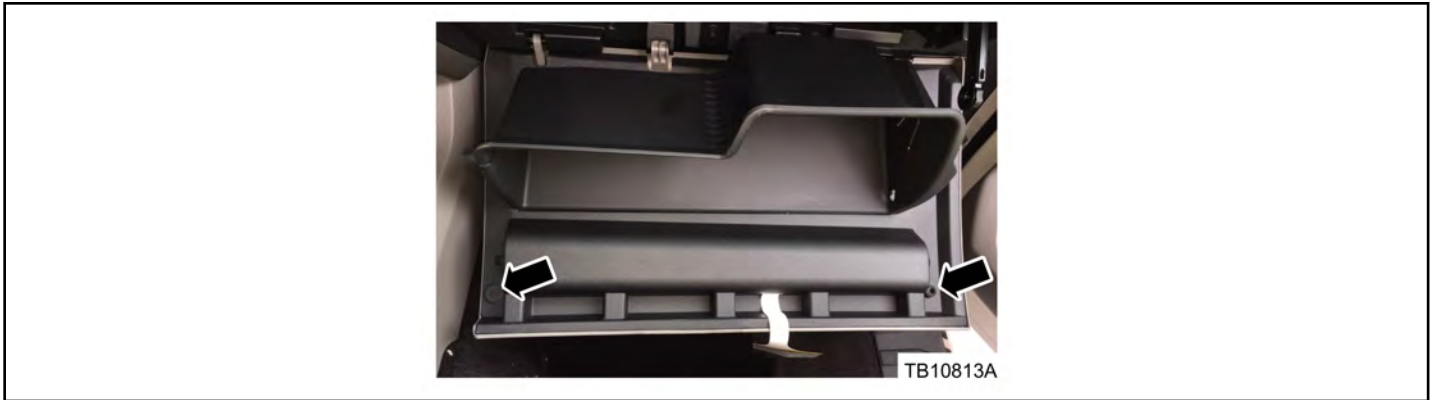

Figure 4 - Article 16-0005

9. Install the 2 (two) new rubber bumpers.
 - a. While supporting the glove compartment, press the 2 (two) new glove compartment bumpers into the open bumper cavities by hand.
10. Install the new glove compartment strikers.
 - a. Insert the short forward vertical edge of the new striker into striker pocket first to engage the tab of the striker.
 - b. Press the long rear vertical edge of the new striker into the striker pocket to engage the clips.
11. Reattach the glove compartment dampener.
12. Latch the glove compartment down stops.
13. Close the glove compartment.

PART NUMBER	PART NAME
FL3Z-1506064-AA	Glove Box - Striker Kit

OPERATION	DESCRIPTION	TIME
160005A	2015 F-150: Inspect And Install The Striker And Bumper Kit Includes Time To Correct Hinge Pins If Necessary (Do Not Use With Any Other Labor Operations)	0.3 Hr.

WARRANTY STATUS:

Eligible Under Provisions Of New Vehicle Limited Warranty Coverage
 Warranty/ESP coverage limits/policies/prior approvals are not altered by a TSB. Warranty/ESP coverage limits are determined by the identified causal part and verified using the OASIS part coverage tool.

DEALER CODING

BASIC PART NO.	CONDITION CODE
1506024	07

**THX AUDIO SYSTEM EQUIPPED - POPPING NOISE FROM SPEAKERS
ON LOW VOLUME/HIGH BASS WHEN USING USB OR BLUETOOTH
AUDIO DEVICE**

TSB 16-0006

LINCOLN:

2015 MKC

ISSUE

Some 2015 MKC vehicles equipped with the THX audio system may exhibit a popping noise from the speakers with the information and entertainment system set at low volume and high bass when using a USB or bluetooth media device.

ACTION

Follow the Service Procedure steps to correct the condition.

SERVICE PROCEDURE

1. Does a popping noise from the speakers occur with the information and entertainment system set at low volume and high bass when using a USB or bluetooth device?
 - a. Yes - proceed to step 2.
 - b. No - this article does not apply. Refer to Workshop Manual (WSM), Section 415-00 for normal diagnostics.
2. Replace the Audio Digital Signal Processing (DSP) Module. Refer to WSM, Section 415-00.

PART NUMBER	PART NAME
EJ7Z-18B849-D	Digital Signal Processing Module

OPERATION	DESCRIPTION	TIME
160006A	2015 MKC: Replace The DSP Module (Do Not Use With Any Other Labor Operations)	0.3 Hr.

WARRANTY STATUS:

Eligible Under Provisions Of New Vehicle Limited Warranty Coverage

Warranty/ESP coverage limits/policies/prior approvals are not altered by a TSB. Warranty/ESP coverage limits are determined by the identified causal part and verified using the OASIS part coverage tool.

DEALER CODING

BASIC PART NO.	CONDITION CODE
18B849	42

NOTE: The information contained in Technical Service Bulletins is intended for use by trained, professional technicians with the knowledge, tools, and equipment to do the job properly and safely. It informs these technicians of conditions that may occur on some vehicles, or provides information that could assist in proper vehicle service. The procedures should not be performed by "do-it-yourselfers". Do not assume that a condition described affects your car or truck. Contact a Ford, Lincoln, or Mercury dealership to determine whether the bulletin applies to your vehicle. Warranty Policy and Extended Service Plan documentation determine Warranty and/or Extended Service Plan coverage unless stated otherwise in the TSB article. The information in this Technical Service Bulletin (TSB) was current at the time of printing. Ford Motor Company reserves the right to supersede this information with updates. The most recent information is available through Ford Motor Company's on-line technical resources.

POLICE UTILITY - 3.7L TiVCT - DELAYED SHIFTS AT SPEEDS CLOSE TO 160 KM/H (100 MPH) - BUILT ON OR BEFORE 11/16/2015

TSB 16-0007

FORD:

2016 Explorer

ISSUE

Some 2016 Explorer Police Utility vehicles equipped with a 3.7L twin independent variable camshaft timing (Ti-VCT) engine may experience random delayed shifts at speeds close to 160 Km/h (100 MPH) under certain conditions.

ACTION

Reprogram the powertrain control module (PCM) to the latest calibration using IDS release 98.01 or higher. Make sure you are connected to the internet when entering module programming to obtain the latest updates. Calibration files may also be obtained at www.motorcraftservice.com

OPERATION	DESCRIPTION	TIME
160007A	2016 Explorer Police 3.7L Ti-VCT: Reprogram The PCM (Do Not Use With Any Other Labor Operations)	0.3 Hr.

WARRANTY STATUS:

Eligible Under Provisions Of New Vehicle Limited Warranty Coverage

Warranty/ESP coverage limits/policies/prior approvals are not altered by a TSB. Warranty/ESP coverage limits are determined by the identified causal part and verified using the OASIS part coverage tool.

DEALER CODING

BASIC PART NO.	CONDITION CODE
RECAL	04

NOTE: The information contained in Technical Service Bulletins is intended for use by trained, professional technicians with the knowledge, tools, and equipment to do the job properly and safely. It informs these technicians of conditions that may occur on some vehicles, or provides information that could assist in proper vehicle service. The procedures should not be performed by "do-it-yourselfers". Do not assume that a condition described affects your car or truck. Contact a Ford, Lincoln, or Mercury dealership to determine whether the bulletin applies to your vehicle. Warranty Policy and Extended Service Plan documentation determine Warranty and/or Extended Service Plan coverage unless stated otherwise in the TSB article. The information in this Technical Service Bulletin (TSB) was current at the time of printing. Ford Motor Company reserves the right to supersede this information with updates. The most recent information is available through Ford Motor Company's on-line technical resources.

**6R80 TRANSMISSION HIGH GEAR ENGAGEMENT FROM A STOP -
VEHICLES BUILT ON OR BEFORE 4/8/2013****TSB 16-0008****FORD:**

2011-2013 F-150

2012-2013 Expedition

2011-2014 Mustang

LINCOLN:

2012-2013 Navigator

This article supersedes TSB **13-06-08** to update the Parts List.

ISSUE

Some 2011-2014 Mustang, 2011-2013 F-150, 2012-2013 Expedition and Navigator vehicles equipped with a 6R80 transmission and built on or before 4/8/2013 may exhibit a transmission engagement in 5th gear when starting. The wrench indicator and/or the seat belt minder may be illuminated, the speedometer reads zero and the odometer displays dashes while driving. Symptoms may clear after an ignition key cycle. Diagnostics trouble codes (DTCs) P0720 and P0722 may or may not be stored in the powertrain control module (PCM) memory.

ACTION

Follow the Service Procedure steps to correct the condition.

SERVICE PROCEDURE

Replace the molded leadframe on the main control assembly. Refer to Workshop Manual (WSM), Section 307-01 Shift Solenoids.

NOTE:

REPLACEMENT OF SHIFT SOLENOIDS ARE NOT REQUIRED FOR THIS PROCEDURE.

PART NUMBER	PART NAME
AL3Z-7G276-B	Molded Leadframe
XT-5-QLVC	Motorcraft® MERCON® LV Automatic Transmission Fluid

OPERATION	DESCRIPTION	TIME
160008A	2011-2013 F-150, 2012-2013 Expedition And Navigator 6R80 Transmission: Check DTCs And Replace The Molded Leadframe (Do Not Use With Any Other Labor Operations)	2.1 Hrs.
160008A	2011-2014 Mustang 6R80 Transmission: Check DTCs And Replace The Molded Leadframe (Do Not Use With Any Other Labor Operations)	2.2 Hrs.

WARRANTY STATUS:

Eligible Under Provisions Of New Vehicle Limited Warranty Coverage And Emissions Warranty Coverage
Warranty/ESP coverage limits/policies/prior approvals are not altered by a TSB. Warranty/ESP coverage limits are determined by the identified causal part and verified using the OASIS part coverage tool.

DEALER CODING

BASIC PART NO.	CONDITION CODE
7G276	D4

NOTE: The information contained in Technical Service Bulletins is intended for use by trained, professional technicians with the knowledge, tools, and equipment to do the job properly and safely. It informs these technicians of conditions that may occur on some vehicles, or provides information that could assist in proper vehicle service. The procedures should not be performed by "do-it-yourselfers". Do not assume that a condition described affects your car or truck. Contact a Ford, Lincoln, or Mercury dealership to determine whether the bulletin applies to your vehicle. Warranty Policy and Extended Service Plan documentation determine Warranty and/or Extended Service Plan coverage unless stated otherwise in the TSB article. The information in this Technical Service Bulletin (TSB) was current at the time of printing. Ford Motor Company reserves the right to supersede this information with updates. The most recent information is available through Ford Motor Company's on-line technical resources.

FORD:

2013-2016 Taurus

ISSUE

Some 2013-2016 Taurus Police sedan vehicles equipped with 3.5L gasoline turbocharged direct injection (GTDI), 3.5L twin independent variable cam timing (Ti-VCT) and 3.7L Ti-VCT engines may exhibit an illuminated malfunction indicator lamp (MIL) with diagnostic trouble code (DTC) P0627 stored in the powertrain control module (PCM) memory.

ACTION

Follow the Service Procedure steps to correct the condition.

SERVICE PROCEDURE

1. Connect the Ford Integrated Diagnostic System (IDS) service tool or equivalent scan tool and check for DTCs. Is DTC P0627 present in PCM memory?
 - a. Yes - replace the fuel pump control module. Refer to Workshop Manual (WSM), Section 303-04.
 - b. No - this article does not apply. Refer to Powertrain Control/Emissions Diagnosis (PC/ED) manual for normal diagnosis.

PART NUMBER	PART NAME
AA8Z-9D370-D	Fuel Pump Control Module

OPERATION	DESCRIPTION	TIME
160009A	2013-2016 Taurus Police: Retrieve DTCs And Replace The Fuel Pump Control Module (Do Not Use With Any Other Labor Operations Except MT)	0.5 Hr.
MT160009	Additional Time To Remove And Install Any Police Equipment To Access The Fuel Pump Control Module	Actual Time

WARRANTY STATUS:

Eligible Under Provisions Of New Vehicle Limited Warranty Coverage And Emissions Warranty Coverage
Warranty/ESP coverage limits/policies/prior approvals are not altered by a TSB. Warranty/ESP coverage limits are determined by the identified causal part and verified using the OASIS part coverage tool.

DEALER CODING

BASIC PART NO.	CONDITION CODE
9D370	42

NOTE: The information contained in Technical Service Bulletins is intended for use by trained, professional technicians with the knowledge, tools, and equipment to do the job properly and safely. It informs these technicians of conditions that may occur on some vehicles, or provides information that could assist in proper vehicle service. The procedures should not be performed by "do-it-yourselfers". Do not assume that a condition described affects your car or truck. Contact a Ford, Lincoln, or Mercury dealership to determine whether the bulletin applies to your vehicle. Warranty Policy and Extended Service Plan documentation determine Warranty and/or Extended Service Plan coverage unless stated otherwise in the TSB article. The information in this Technical Service Bulletin (TSB) was current at the time of printing. Ford Motor Company reserves the right to supersede this information with updates. The most recent information is available through Ford Motor Company's on-line technical resources.



Michael A. Berardi
Director
Service Engineering Operations
Ford Customer Service Division

Ford Motor Company
P. O. Box 1904
Dearborn, Michigan 48121

January 7, 2016

TO: All U.S. Ford and Lincoln Dealers

SUBJECT: **Customer Satisfaction Program 15B23**
Certain 2012-2014 Focus Electric Vehicles
High Voltage Wire Harness Update and Reprogram Powertrain Control Module

PROGRAM TERMS

This program will be in effect through December 31, 2016. There is no mileage limit for this program.

AFFECTED VEHICLES

Vehicle	Model Year	Assembly Plant	Build Dates
Focus Electric	2012-2014	Michigan Assembly Plant	September 15, 2011 through August 15, 2014

Affected vehicles are identified in OASIS and FSA VIN Lists.

REASON FOR THIS PROGRAM

In some of the affected vehicles a “Stop Safely Now” message with a red triangle indicator may appear in the instrument cluster, followed by loss of motive power. The Malfunction Indicator Lamp (MIL) may also illuminate with Diagnostic Trouble Code (DTC) P0A0A-01 present in the Powertrain Control Module (PCM).

SERVICE ACTION

Depending on the build date of the vehicle and based on inspection results, dealers are to perform one of the following:

- Vehicles built before May 19, 2014 - inspect the High Voltage (HV) wire harness and reprogram the PCM.
- Vehicles built before May 19, 2014 - inspect the HV wire harness, update the HV wire harness, and reprogram the PCM.
- Vehicles built on or after May 19, 2014 - clean and apply electrical grease to the Powertrain High Voltage Interlock (PT HVIL) terminal shunt and reprogram the PCM.

The above services must be performed on all affected vehicles at no charge to the vehicle owner.

NOTE: To prevent the risk of high-voltage shock, it is strongly recommended the service procedure is performed by a technician that has completed the Hybrid and Electric Vehicle Operation & Diagnosis Classroom Training (course code 39S02T0).

OWNER NOTIFICATION MAILING SCHEDULE

Owner Letters are expected to be mailed the week of January 25, 2016. Dealers should repair any affected vehicles that arrive at their dealerships, whether or not the customer has received a letter.

ATTACHMENTS

Attachment I: Administrative Information
Attachment II: Labor Allowances and Parts Ordering Information
Attachment III: Technical Information

QUESTIONS & ASSISTANCE

For questions and assistance, contact the Special Service Support Center (SSSC) via the SSSC Web Contact Site. The SSSC Web Contact Site can be accessed through the Professional Technician Society (PTS) website using the SSSC link listed at the bottom of the OASIS VIN report screen or listed under the SSSC tab.

Sincerely,



Michael A. Berardi

Customer Satisfaction Program 15B23
Certain 2012-2014 Focus Electric Vehicles
High Voltage Wire Harness Update and Reprogram Powertrain Control Module

OASIS ACTIVATED

Yes, OASIS will be activated on January 7, 2016.

FSA VIN LIST ACTIVATED

Yes, FSA VIN list will be available through <https://web.fsavinlists.dealerconnection.com> on January 7, 2016. Owner names and addresses will be available by February 8, 2016.

NOTE: Your FSA VIN list may contain owner names and addresses obtained from motor vehicle registration records. The use of such motor vehicle registration data for any purpose other than in connection with this program is a violation of law in several states, provinces, and countries. Accordingly, you must limit the use of this listing to the follow-up necessary to complete this service action.

STOCK VEHICLES

- Correct all affected units in your new vehicle inventory before delivery.
- Use OASIS to identify any affected vehicles in your used vehicle inventory.

SOLD VEHICLES

- Owners of affected vehicles will be directed to dealers for repairs.
- Immediately contact any of your affected customers whose vehicles are not on your VIN list but are identified in OASIS. Give the customer a copy of the Owner Notification Letter (when available) and schedule a service date.
- Correct other affected vehicles identified in OASIS which are brought to your dealership.

TITLE BRANDED / SALVAGED VEHICLES

Affected title branded and salvaged vehicles are eligible for this service action.

ADDITIONAL LABOR TIME AND/OR PARTS

Submit a request to the SSSC Web Contact Site prior to the repair if you have any of the following:

- Damage that you believe was caused by the covered condition.
- A condition that requires additional labor and/or parts to complete the repair.
- Aftermarket equipment or non-Ford modifications to the vehicle which might prevent the repair of the covered condition.

Requests for approval after completion of the repair may not be granted. Ford Motor Company reserves the right to deny coverage for related damage in cases where the vehicle owner has not had this repair performed on a timely basis. Additional related damage parts are subject to random selection for return to the Ford Warranty Parts Analysis Center (WPAC).

Customer Satisfaction Program 15B23
Certain 2012-2014 Focus Electric Vehicles
High Voltage Wire Harness Update and Reprogram Powertrain Control Module

OWNER REFUNDS

- Ford Motor Company is offering a refund for owner-paid repairs covered by this program if the repair was performed before the date of the Owner Notification Letter. This refund offer expires August 1, 2016.
- Dealers are also pre-approved to refund owner-paid emergency repairs that were performed away from an authorized servicing dealer after the date of the Owner Notification Letter. There is no expiration date for emergency repair refunds. Non-covered repairs, or those judged by Ford to be excessive, will not be reimbursed.
- Refunds will only be provided for the cost associated with diagnosing and repairing PCM DTC P0A0A-01 when the High Voltage Wire Harness was determined to be the causal component.

RENTAL VEHICLES

Dealers are pre-approved for a comparable rental vehicle for 1 day. Follow Extended Service Plan (ESP) guidelines for dollar amounts. Rentals will only be reimbursed for the day the vehicle is at the dealership for part replacement. Prior approval for more than 1 rental day is required from the SSSC via the SSSC Web Contact Site.

CLAIMS PREPARATION AND SUBMISSION

- Enter claims using Direct Warranty Entry (DWE) or One Warranty Solution (OWS).
 - DWE: refer to ACESII manual for claims preparation and submission information.
 - OWS: when entering claims in DMS software, select claim type 31: Field Service Action. The FSA number 15B23 is the sub code.
- Additional labor and/or parts must be claimed as related damage on a separate repair line from which the FSA is claimed. Additional labor and/or parts require prior approval from the SSSC via the SSSC Web Contact Site.
- Submit refunds on a separate repair line.
 - Program Code: 15B23
 - Misc. Expense: ADMIN
 - Misc. Expense: REFUND
 - Misc. Expense: 0.2 Hrs.
- Multiple refunds should be submitted on one repair line and the invoice details for each repair should be detailed in the comments section of the claim.
- For rental vehicle claiming, follow Extended Service Plan (ESP) guidelines for dollar amounts. Enter the total amount of the rental expense under Miscellaneous Expense code "Rental".
- PROGRAM TERMS: This program will be in effect through December 31, 2016. There is no mileage limit for this program.

Customer Satisfaction Program 15B23
Certain 2012-2014 Focus Electric Vehicles
High Voltage Wire Harness Update and Reprogram Powertrain Control Module

LABOR ALLOWANCES

Description	Labor Operation	Labor Time
Vehicles built before May 19, 2014 - inspect the HV wire harness and reprogram the PCM	15B23B	0.5 Hours
Vehicles built before May 19, 2014 - inspect the HV wire harness, update the HV wire harness, and reprogram the PCM	15B23C	1.1 Hours
Vehicles built on or after May 19, 2014 - clean and apply electrical grease to the PT HVIL terminal shunt and reprogram the PCM	15B23D	0.7 Hours

PARTS REQUIREMENTS / ORDERING INFORMATION

Part Number	Description	Quantity
XG-12	Electrical Grease	1
CM58-12B654-AA	High Voltage Wire Harness Update Kit (Vehicles Built before May 19, 2014, as required)	1

The DOR/COR number for this program is 51017.

Order your parts requirements through normal order processing channels.

DEALER PRICE

For latest prices, refer to DOES II.

PARTS RETENTION AND RETURN

Follow the provisions of the Warranty and Policy Manual, Section 1 "WARRANTY PARTS RETENTION AND RETURN POLICIES."





EXCESS STOCK RETURN

Excess stock returned for credit must have been purchased from Ford Customer Service Division in accordance with Policy Procedure Bulletin 4000.

CERTAIN 2012 THROUGH 2014 MODEL YEAR FOCUS ELECTRIC VEHICLES — HIGH VOLTAGE WIRE HARNESS INSPECTION AND POWERTRAIN CONTROL MODULE REPROGRAMMING

OVERVIEW

In some of the affected vehicles a "Stop Safely Now" message with a red triangle indicator may appear in the instrument cluster, followed by loss of motive power. The Malfunction Indicator Lamp (MIL) may also illuminate with Diagnostic Trouble Code (DTC) P0A0A-01 present in the Powertrain Control Module (PCM). Depending on the build date of the vehicle and based on inspection results, dealers are to update the High Voltage (HV) wire harness, clean and apply electrical grease to the Powertrain High Voltage Interlock (PT HVIL) Terminal Shunt, and reprogram the PCM.

-  **WARNING:** Service of the high voltage system on this vehicle is restricted to qualified personnel. The required qualifications vary by region. Always observe local laws and legislative directives regarding electric vehicle service. Failure to follow this instruction may result in serious personal injury or death.
-  **WARNING:** To prevent the risk of high-voltage shock, always follow precisely all warnings and service instructions, including instructions to depower the system. The high-voltage system utilizes approximately 300 volts DC, provided through high-voltage cables to its components and modules. The high-voltage cables and wiring are identified by orange harness tape or orange wire covering. All high-voltage components are marked with high-voltage warning labels with a high-voltage symbol. Failure to follow these instructions may result in serious personal injury or death.
-  **WARNING:** Never install the service disconnect plug when a high-voltage service cover is removed. Always install the cover prior to connecting the service disconnect plug. The cover prevents inadvertent contact with the high voltage which is present at several points under the cover. Failure to follow these instructions may result in serious personal injury or death.
-  **WARNING:** Disconnect the 12 volt battery before servicing the direct current to alternating current (DC-AC) inverter or alternating current (AC) powerpoint to prevent the risk of high voltage shock. Failure to follow this instruction may result in serious personal injury.

SERVICE PROCEDURE

Vehicles Built Before May 19, 2014 - Proceed to Page 2.

Vehicles Built On or After May 19, 2014 - Proceed to Page 9.



Vehicles Built Before May 19, 2014

Inspect High Voltage Wire Harness

1. Remove the two engine cover retainer pins, then remove the engine cover.
2. Inspect the HV wire harness. See Figure 1a.

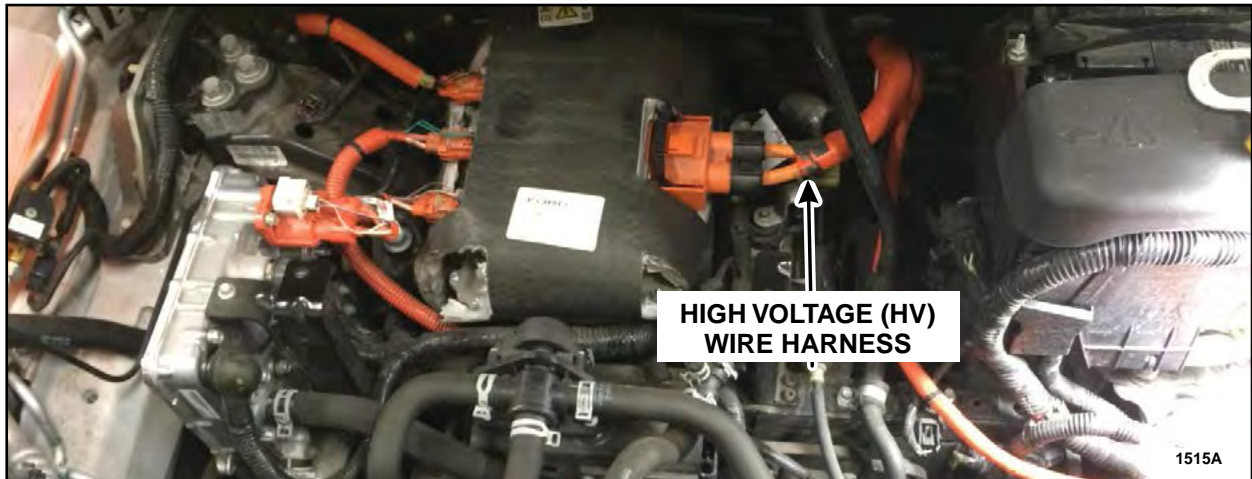

FIGURE 1a

3. Are the HV wires individually wrapped in convolute? See Figures 1b and 1c.
 - Yes - HV wire harness update is not required. Proceed to Module Reprogramming on Page 11.
 - No - Proceed to Update High Voltage Wire Harness on Page 3.

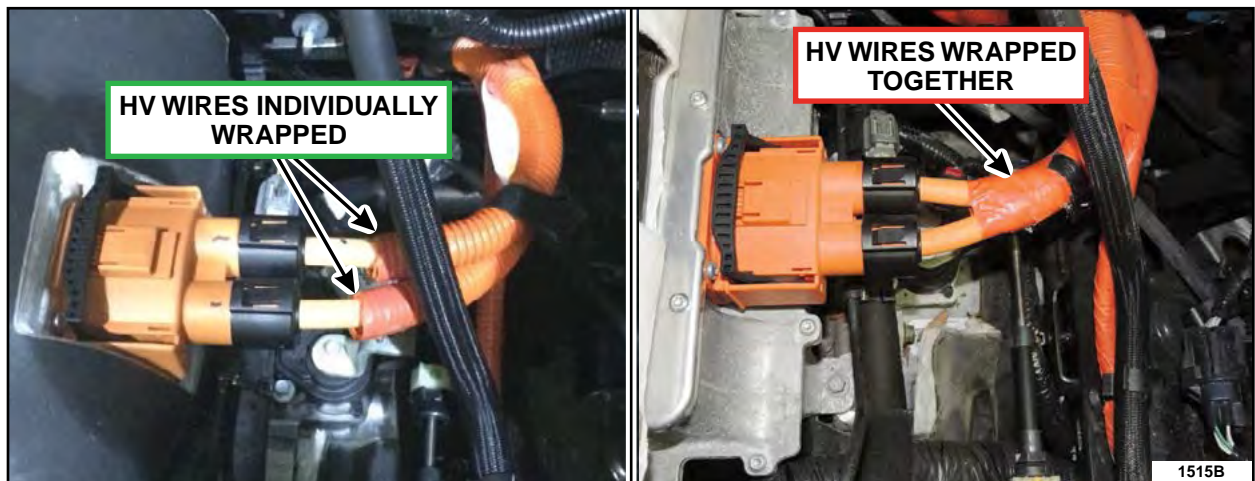

FIGURE 1b

FIGURE 1c



Update High Voltage Wire Harness

1. Disconnect the HV battery service disconnect. Please follow the Workshop Manual (WSM) procedures in Section 414-03A.
2. Disconnect the Transmission Control Module (TCM) connector. See Figure 2.

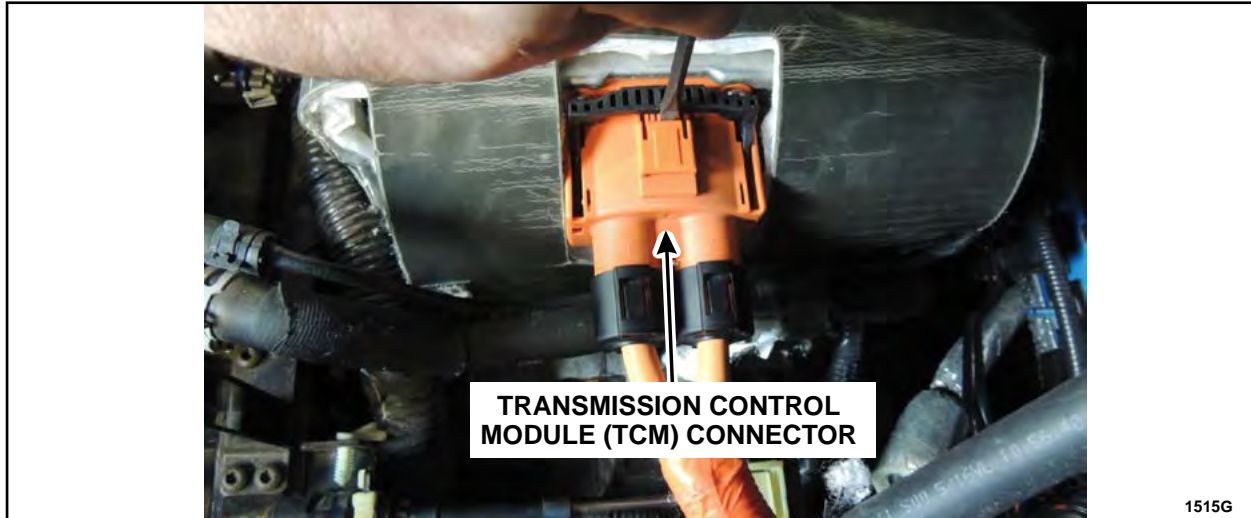

FIGURE 2

NOTE: Do not use a razor blade, utility knife or similar tool for cutting the convolute and tape. The HV wire harness can easily become damaged if round/blunt nose scissors are not used when performing this procedure. See Figure 3.

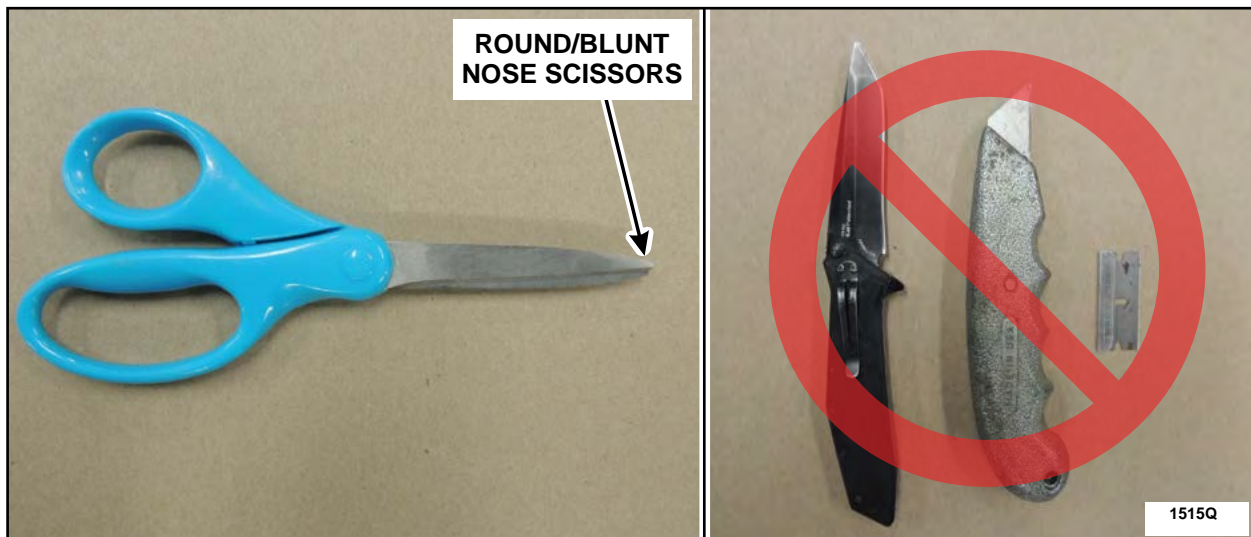

FIGURE 3



- Using a pair of round/blunt nose scissors, cut the single convolute between the wires down to the black tape at the dash bracket and discard the cut convolute. Peel back the convolute as you cut for better visibility. See Figures 4a, 4b and 4c.

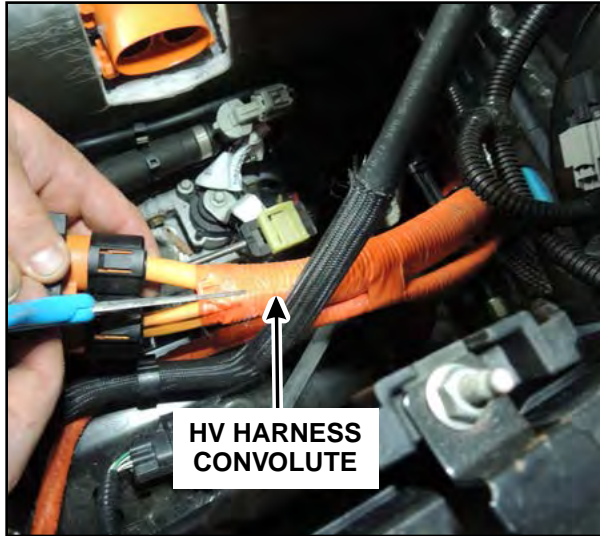

FIGURE 4a

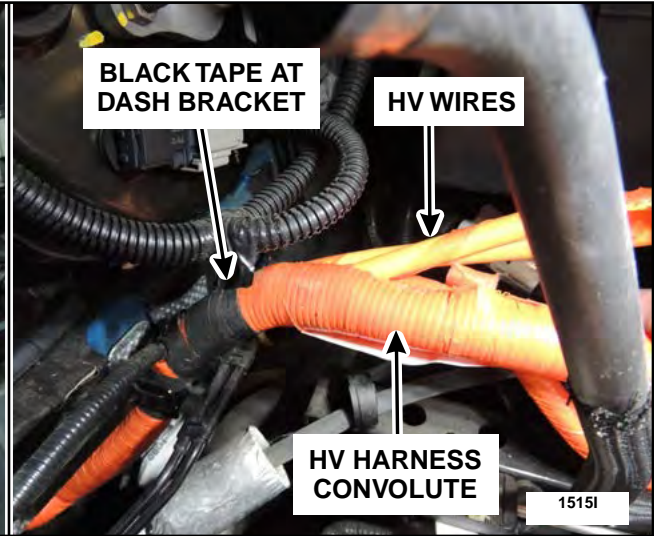

FIGURE 4b

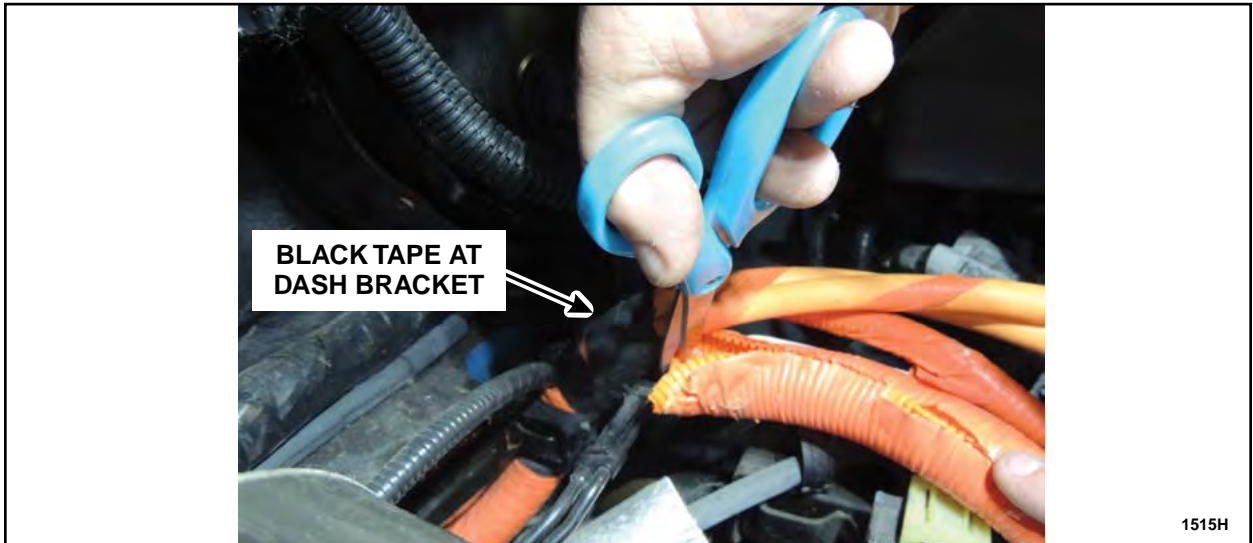

FIGURE 4c



4. Install the abrasion sleeves individually over each HV wire. See Figures 5 and 6.



FIGURE 5

5. Install the supplied tie-straps to the HV wire harness in the sequence shown. Tie-strap "5" secures the unmodified HV wire to the nearest modified HV wire. Install the tie-straps so the straps are facing away from each other. Cut off excess length of the tie-straps. See Figure 6.

NOTE: The unmodified HV wire must be secured to only one of the modified HV wires.

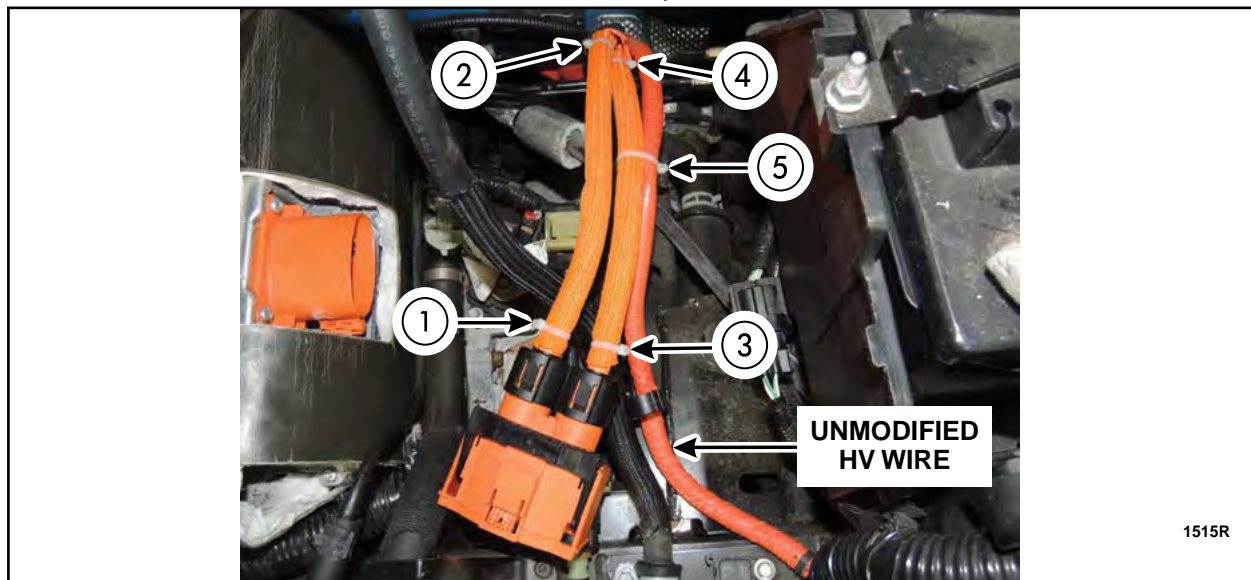

FIGURE 6



6. Remove the four TCM connector terminal springs using a terminal release tool, pick or bent paper clip. Each TCM terminal contains two springs. See Figure 7.

NOTICE: Do not scratch or damage the terminal surface or spring grooves.

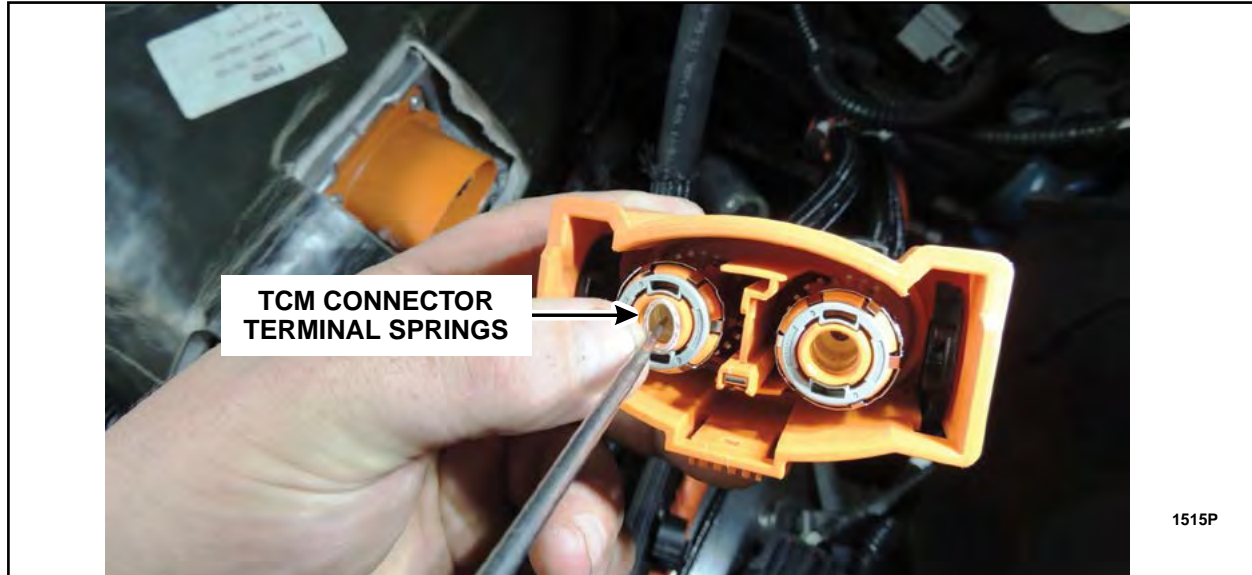

FIGURE 7

7. Install the four *new* TCM connector terminal springs using a terminal release tool, pick or bent paper clip. Place the springs into their correct position and seat in the grooves. See Figure 8.

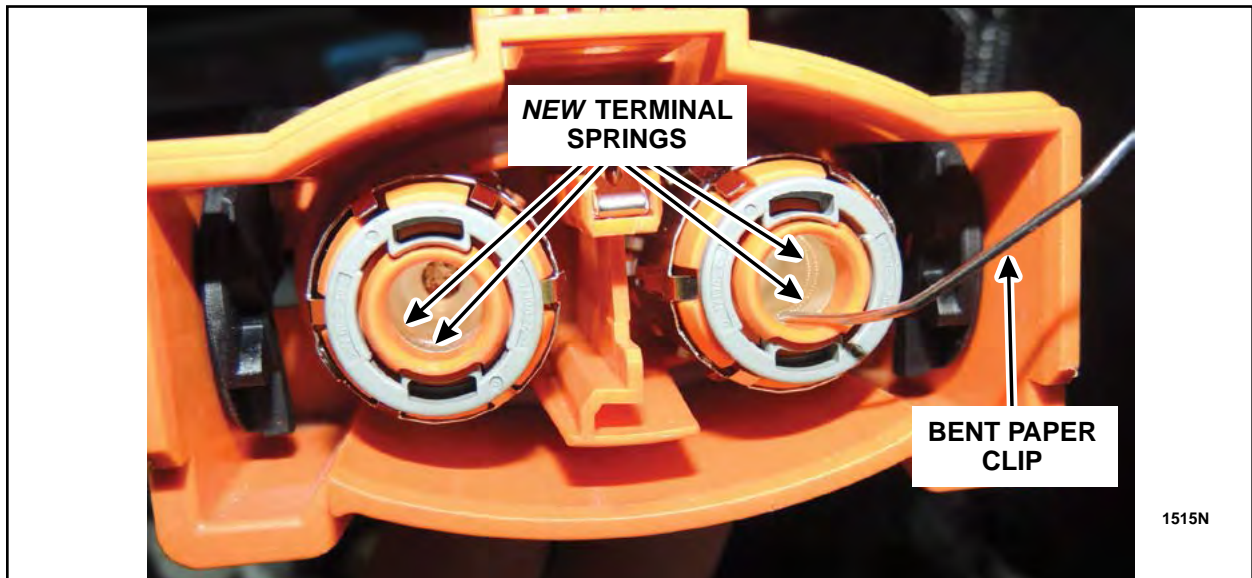

FIGURE 8



- Turn the TCM connector upside down and locate the Powertrain High Voltage Inter-Lock (PT HVIL) Terminal Shunt locking tab access hole. Using an angled pick, depress the tab while pulling the shunt out of the connector and discard the shunt. See Figure 9.

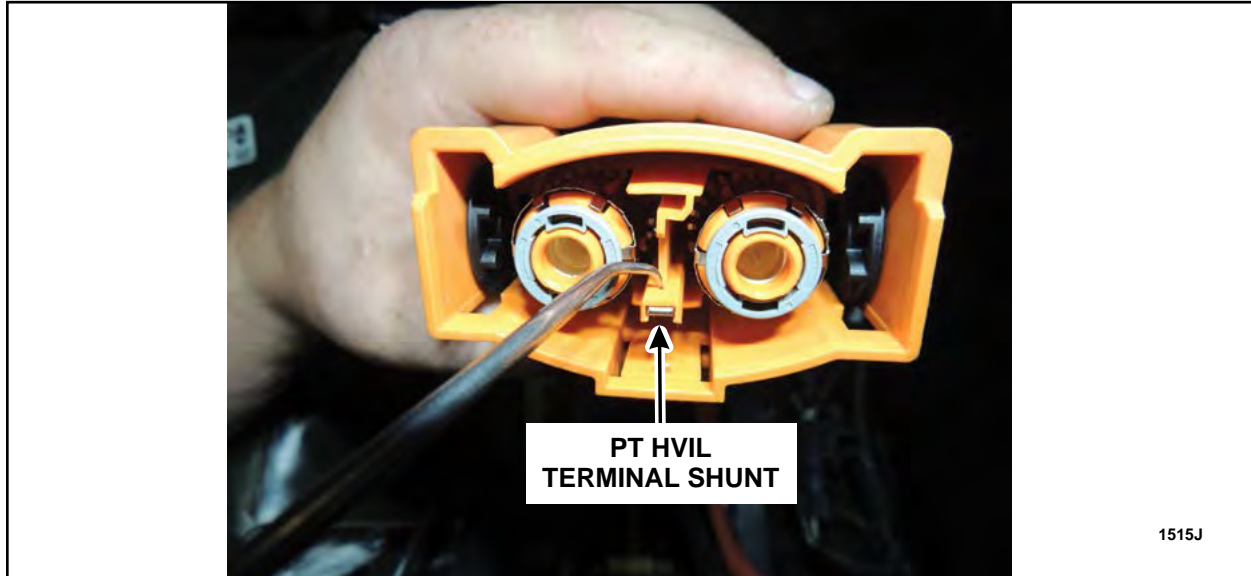

FIGURE 9

NOTICE: Use latex gloves for this portion of the repair. Be careful not to touch the gold surface of the *new* shunt.

NOTICE: Do not compress the *new* shunt when installing into the TCM connector.

- Install the *new* PT HVIL Terminal Shunt by slowly sliding into the slotted opening until an audible "click" is heard and the shunt is locked in place. See Figure 10.

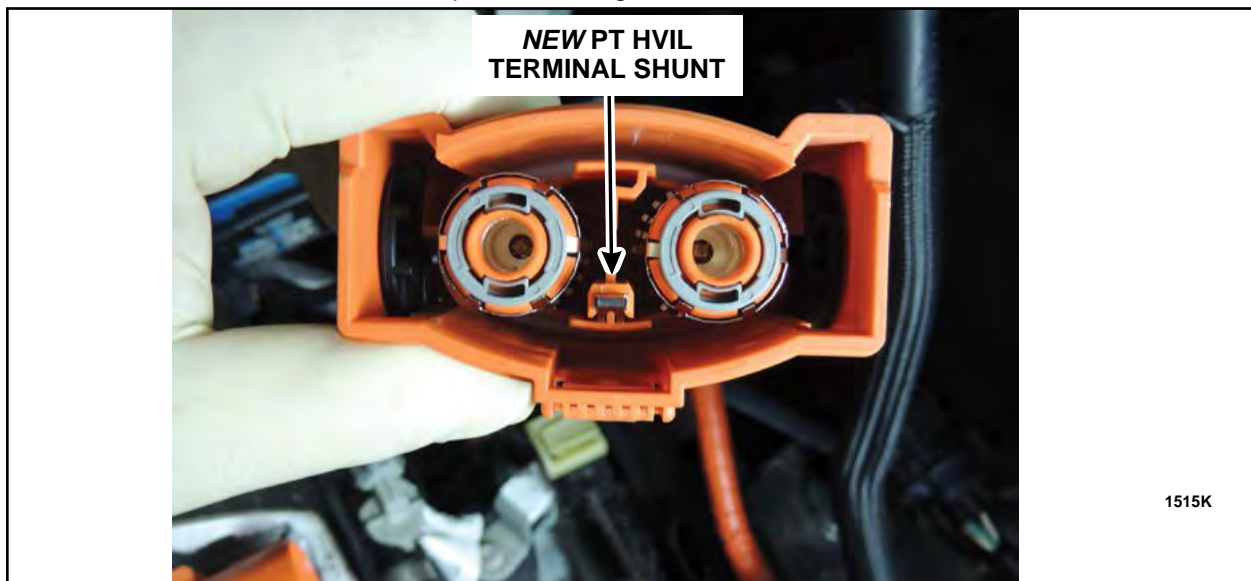

FIGURE 10



10. Using a lint free cloth, lightly wipe all surfaces of the shunt after installation. Apply Motorcraft Electrical Grease XG-12 to the *new* PT HVIL Terminal Shunt. See Figure 11.

NOTE: Apply the grease to the PT HVIL Terminal Shunt only.

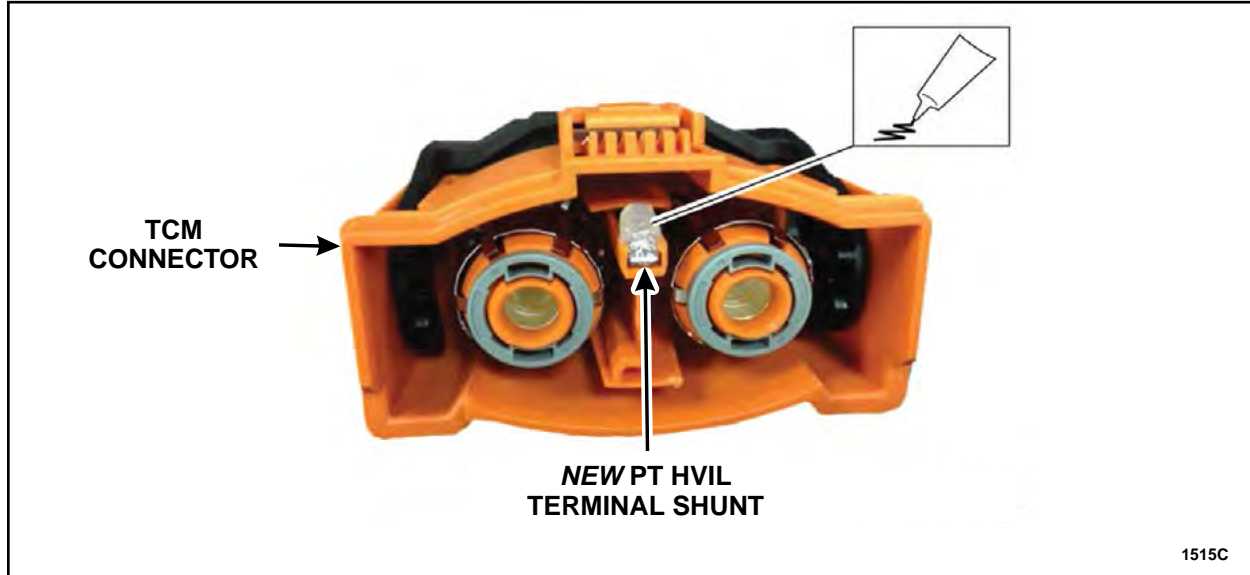

FIGURE 11

11. Connect and disconnect the TCM connector. See Figure 2.
12. Verify all components remain in the correct position. See Figures 8 and 10.
13. Reconnect the TCM connector. See Figure 2.
14. Install the engine cover and the two engine cover retainer pins.
15. Connect the HV battery service disconnect. Please follow the WSM procedures in Section 414-03A.
16. Proceed to Module Reprogramming on Page 11.



Vehicles Built On or After May 19, 2014

Clean and Apply Electrical Grease to the PT HVIL Terminal Shunt

1. Disconnect the High Voltage (HV) battery service disconnect. Please follow the Workshop Manual (WSM) procedures in Section 414-03A.
2. Remove the two engine cover retainer pins, then remove the engine cover.
3. Disconnect the Transmission Control Module (TCM) connector. See Figure 12.

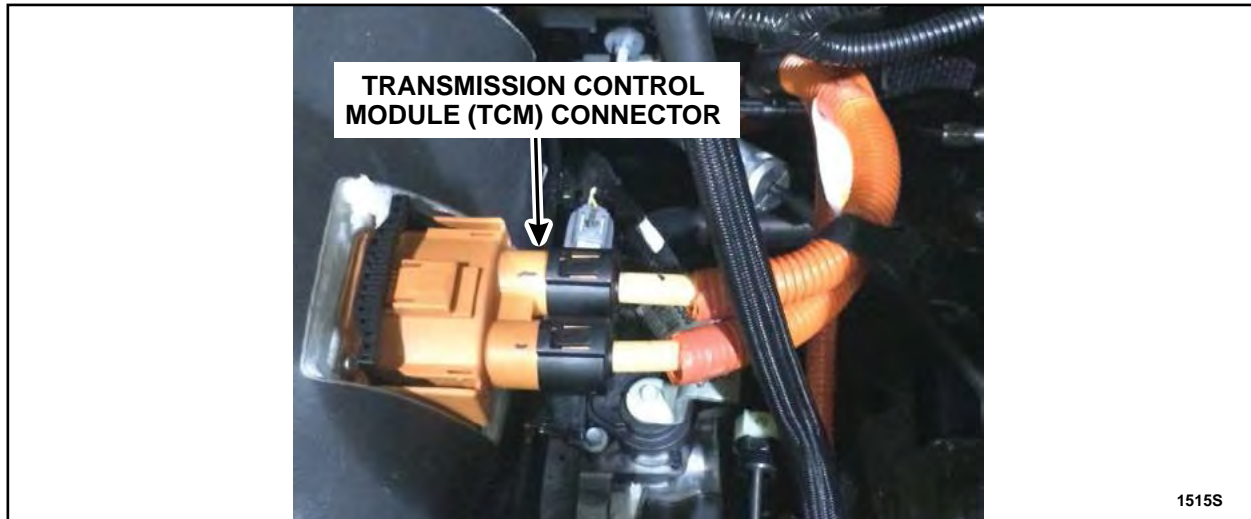

FIGURE 12

4. Using a lint free cloth, lightly wipe all surfaces of the Powertrain High Voltage Inter-Lock (PT HVIL) Terminal Shunt. Apply Motorcraft Electrical Grease XG-12 to the (PT HVIL) Terminal Shunt. See Figure 13.

NOTE: Apply the grease to the PT HVIL Terminal Shunt only.

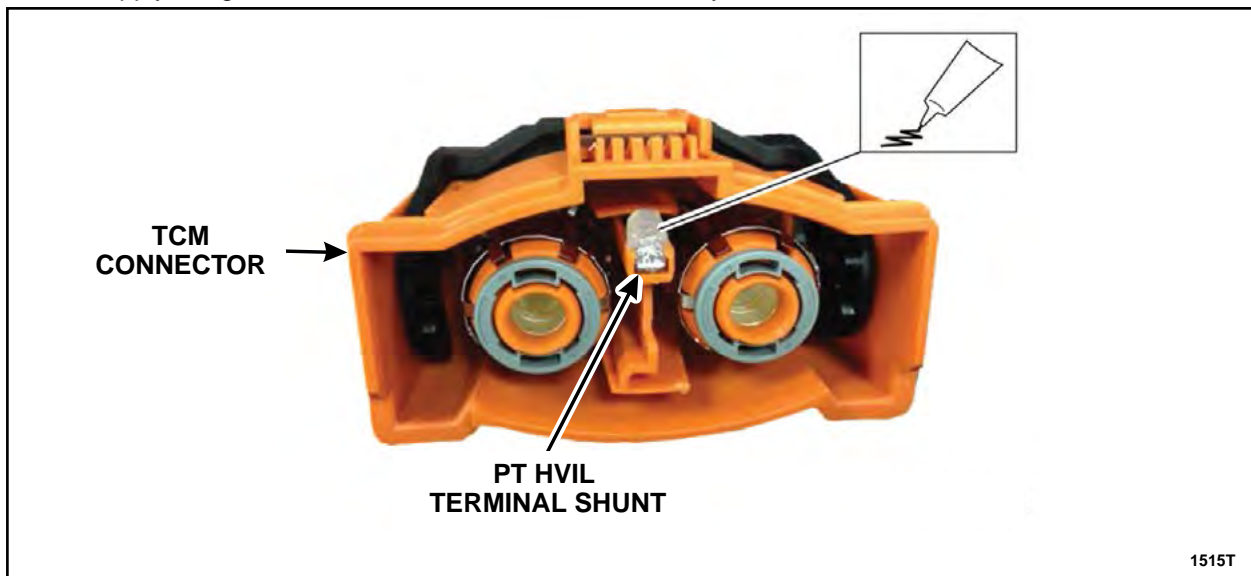

FIGURE 13



5. Connect the TCM connector. See Figure 12.
6. Install the engine cover and the two engine cover retainer pins.
7. Connect the HV battery service disconnect. Please follow the WSM procedures in Section 414-03A.
8. Proceed to Module Reprogramming on Page 11.



Module Reprogramming - All Vehicles

NOTE: Reprogram appropriate vehicle modules before performing diagnostics and clear all Diagnostic Trouble Codes (DTCs) after programming. For DTCs generated after reprogramming, follow normal diagnostic service procedures.

1. Connect a battery charger to the 12V battery.
2. Reprogram the Powertrain Control Module (PCM) using Integrated Diagnostic System (IDS) release 93.03 or higher.

NOTE: A coordinated reflash is required when reprogramming the PCM. When PCM reprogramming is initiated, the IDS will check for software updates on certain onboard modules (Anti-lock Brake System (ABS) module, Transmission Control Module (TCM), etc.). The IDS will automatically install updates in these modules if they are not at the latest level. If the coordinated reflash is interrupted, undesired vehicle operation may result.

NOTE: Calibration files may also be obtained at www.motorcraftservice.com.

NOTE: Follow the IDS on-screen instructions to complete the reprogramming procedure.

3. Disconnect the battery charger from the 12V battery, once reprogramming has completed.

Important Information for Module Programming

NOTE: When programming or reprogramming a module, use the following basic checks to ensure programming completes without errors.

- Make sure the 12V battery is fully charged before carrying out the programming steps and connect IDS/scan tool to a power source.
- Inspect Vehicle Communication Module (VCM) and cables for any damage. Make sure scan tool connections are not interrupted during programming.
- A hardwired connection is strongly recommended.
- Turn off all unnecessary accessories (radio, heated/cooled seats, headlamps, interior lamps, HVAC system, etc.) and close doors.
- Disconnect/depower any aftermarket accessories (remote start, alarm, power inverter, CB radio, etc.).
- Follow all scan tool on-screen instructions carefully.
- Disable IDS/scan tool sleep mode, screensaver, hibernation modes.
- Create all sessions Key On Engine Off (KOEO). Starting the vehicle before creating a session will cause errors within the programming inhale process.



**Recovering a module when programming has resulted in a blank module:
NEVER DELETE THE ORIGINAL SESSION!**

- a. Obtain the original IDS that was used when the programming error occurred during Module Reprogramming (MR) or Programmable Module Installation (PMI).
- b. Disconnect the VCM from the Data Link Connector (DLC) and the IDS.
- c. Reconnect the VCM to IDS and then connect to the DLC. Once reconnected, the VCM icon should appear in the corner of the IDS screen. If it does not, troubleshoot the IDS to VCM connection.
- d. Locate the ORIGINAL vehicle session when programming failed. This should be the last session used in most cases. If not, use the session created on the date that the programming failed.

NOTE: If the original session is not listed in the previous session list, click the "Recycle Bin" icon at the lower right of the previous session screen. This loads any deleted sessions and allows you to look through them. Double-click the session to restore it.

- e. Once the session is loaded, the failed process should resume automatically.
- f. If programming does not resume automatically, proceed to the Module Programming menu and select the previously attempted process, PMI or MR.
- g. Follow all on-screen prompts/instructions.
- h. The last screen on the IDS may list additional steps required to complete the programming process. Make sure all applicable steps listed on the screen are followed in order.





Ford Motor Company
Ford Customer Service Division
P. O. Box 1904
Dearborn, Michigan 48121

January 2016

Customer Satisfaction Program 15B23
Programa de satisfacción del cliente 15B23

Mr. John Sample
123 Main Street
Anywhere, USA 12345

Your Vehicle Identification Number (VIN): 12345678901234567

At Ford Motor Company, we are committed not only to building high quality, dependable products, but also to building a community of happy, satisfied customers. To demonstrate that commitment, we are providing a no-charge Customer Satisfaction Program for your vehicle with the VIN shown above.

Why are you receiving this notice?



“Stop Safely Now”

On your vehicle, a fault in the High Voltage wire harness may cause a “Stop Safely Now” message with a red triangle indicator to appear in the instrument cluster and the Malfunction Indicator Lamp (MIL) may also illuminate. Your vehicle will continue to function normally at speeds above 3 mph; however, you may begin to lose motive power as you bring your vehicle to a stop. If this condition occurs before your dealer visit, you can restart your vehicle by shifting it into Park, turning the vehicle off, and waiting two minutes.

What will Ford and your dealer do?

In the interest of customer satisfaction, Ford Motor Company has authorized your dealer to inspect and update the High Voltage wire harness as required and update the Powertrain Control Module (PCM) calibration free of charge (parts and labor) under the terms of this program.

This Customer Satisfaction Program will be in effect until December 31, 2016 regardless of mileage. Coverage is automatically transferred to subsequent owners.

How long will it take?

The time needed for this repair is less than one-half day. However, due to service scheduling requirements, your dealer may need your vehicle for a longer period of time. In addition, your vehicle may require an inspection to determine if parts need to be ordered.

What should you do?

Please call your dealer without delay and request a service date for Customer Satisfaction Program 15B23. Provide the dealer with the VIN of your vehicle. The VIN is printed near your name at the beginning of this letter.

If you do not already have a servicing dealer, you can access www.Fordowner.com for dealer addresses, maps, and driving instructions. Ford Motor Company wants you to have this service action completed on your vehicle. The vehicle owner is responsible for making arrangements to have the work completed.

Have you previously paid for this repair?

If you have previously paid for a repair that addresses the issue described in this letter, you still need to have this service action performed to ensure the correct parts and procedures were used.

If the previously paid for repair was performed before the date of this letter, you may be eligible for a refund. Refunds will only be provided for service related to Powertrain Control Module (PCM) Diagnostic Trouble Code (DTC) P0A0A-01 when the High Voltage Wire Harness was determined to be causing the concern. To verify eligibility and expedite reimbursement, give your paid original receipt to your dealer before August 1, 2016.

What if you no longer own this vehicle?

If you no longer own this vehicle, and have an address for the current owner, please forward this letter to the new owner.

You received this notice because our records, which are based primarily on state registration and title data, indicate that you are the current owner.

Can we assist you further?

If you have difficulties getting your vehicle repaired promptly and without charge, please contact your dealership's Service Manager for assistance.

RETAIL OWNERS: If you still have concerns, please contact the Ford Motor Company Customer Relationship Center at 1-866-436-7332 and one of our representatives will be happy to assist you. For the hearing impaired call 1-800-232-5952 (TDD). Representatives are available Monday through Friday: 8:00AM – 8:00PM (Eastern Time).

If you wish to contact us through the Internet, our address is: www.Fordowner.com.

Si necesita ayuda o tiene alguna pregunta, por favor llame al Centro de Relación con Clientes al 1-866-436-7332 y presione 2 para Español.

FLEET OWNERS: If you still have concerns, please contact the Fleet Customer Information Center at 1-800-34-FLEET, Option #3 and one of our representatives will be happy to assist you. Representatives are available Monday through Friday: 8:00AM - 8:00PM (Eastern Time).

Or you may contact us through the Internet at www.fleet.ford.com.

Thank you for your attention to this important matter.

Ford Customer Service Division



Michael A. Berardi
Director
Service Engineering Operations
Ford Customer Service Division

Ford Motor Company
P. O. Box 1904
Dearborn, Michigan 48121

January 14, 2016

TO: All U.S. Ford and Lincoln Dealers

SUBJECT: **Customer Satisfaction Program 15M02**
Certain 2011-2015 Model Year F-Super Duty Vehicles with 6.7L Diesel Engine
Exhaust Gas Temperature Sensor Extended Coverage

REF: **Customer Satisfaction Program 15M01**
Certain 2011-2012 Model Year F-Super Duty Vehicles with 6.7L Diesel Engine
Exhaust Gas Temperature Sensor Extended Coverage

PROGRAM TERMS

This Customer Satisfaction Program supersedes 15M01 and extends the coverage of the Exhaust Gas Temperature (EGT) sensors to 11 years of service or 120,000 miles from the warranty start date of the vehicle, whichever occurs first. If a vehicle has already exceeded either the time or mileage limits, this extended warranty coverage will last through July 31, 2016. Coverage is automatically transferred to subsequent owners.

NOTE: This program DOES NOT apply to vehicles that qualify for repairs under the New Vehicle Limited Warranty. Repairs for vehicles covered by New Vehicle Limited Warranty should be claimed using the Labor Operation Codes provided in TSB 15-0054.

VEHICLES COVERED BY THIS PROGRAM

Vehicle	Model Year	Engine	Assembly Plant	Build Dates
F-Super Duty	2011-2015	6.7L Diesel	Kentucky	Job #1 through June 27, 2014

Affected vehicles are identified in OASIS.

REASON FOR PROVIDING EXTENDED WARRANTY COVERAGE

In some of the affected vehicles, the Service Engine Soon indicator may illuminate due to a malfunction with one or more of the EGT sensors.

SERVICE ACTION

If an affected vehicle exhibits this condition, dealers are to replace the faulty EGT sensor(s). Coverage under this program begins after the expiration of the New Vehicle Limited Warranty. This service must be performed at no charge to the vehicle owner.

OWNER NOTIFICATION MAILING SCHEDULE

Owner Letters are expected to be mailed the week of March 21, 2016. Dealers should repair any affected vehicles that experience the condition covered by this program, whether or not the customer has received a letter.

ATTACHMENTS

Attachment I: Administrative Information
Attachment II: Labor Allowances and Parts Ordering Information
Attachment III: Technical Information
Owner Notification Letter

QUESTIONS & ASSISTANCE

For questions and assistance, contact the Special Service Support Center (SSSC) via the SSSC Web Contact Site. The SSSC Web Contact Site can be accessed through the Professional Technician Society (PTS) website using the SSSC link listed at the bottom of the OASIS VIN report screen or listed under the SSSC tab.

Sincerely,



Michael A. Berardi

Customer Satisfaction Program 15M02
Certain 2011-2015 Model Year F-Super Duty Vehicles with 6.7L Diesel Engine
Exhaust Gas Temperature Sensor Extended Coverage

OASIS ACTIVATION

OASIS will be activated on January 14, 2016.

FSA VIN LISTS ACTIVATION

FSA VIN Lists will not be activated for this service action.

STOCK VEHICLES

Do not perform this program unless the affected vehicle exhibits the covered condition.

SOLD VEHICLES

Only owners with affected vehicles that exhibit the covered condition will be directed to dealers for repairs.

TITLE BRANDED / SALVAGED VEHICLES

Affected vehicles which have had the Engine, Powertrain, or Entire Vehicle Warranty cancelled are not eligible for this service action. Warranty cancellation is identified in the "Warning" area on OASIS.

ADDITIONAL LABOR TIME AND/OR PARTS

Submit a request to the SSSC Web Contact Site prior to the repair if you have any of the following:

- Damage that you believe was caused by the covered condition.
- A condition that requires additional labor and/or parts to complete the repair.
- Aftermarket equipment or non-Ford modifications to the vehicle which might prevent the repair of the covered condition.

Requests for approval after completion of the repair may not be granted. Additional related damage parts are subject to random selection for return to the Ford Warranty Parts Analysis Center (WPAC).

OWNER REFUNDS

- Ford Motor Company is offering a refund for owner-paid repairs covered by this program if the repair was performed before the date of the Owner Notification Letter. This refund offer expires July 31, 2016.
- Dealers are also pre-approved to refund owner-paid emergency repairs that were performed away from an authorized servicing dealer after the date of the Owner Notification Letter. There is no expiration date for emergency repair refunds. Non-covered repairs, or those judged by Ford to be excessive, will not be reimbursed.
- Refunds will only be provided for the cost associated with EGT sensor replacement.

RENTAL VEHICLES

The use of rental vehicles is not approved for this program.

Customer Satisfaction Program 15M02

Certain 2011-2015 Model Year F-Super Duty Vehicles with 6.7L Diesel Engine
Exhaust Gas Temperature Sensor Extended Coverage

CLAIMS PREPARATION AND SUBMISSION

- Enter claims using Direct Warranty Entry (DWE) or One Warranty Solution (OWS).
 - DWE: refer to ACESII manual for claims preparation and submission information.
 - OWS: when entering claims in DMS software, select claim type 31: Field Service Action. The FSA number (15M02) is the sub code.
- Additional labor and/or parts must be claimed as related damage on a separate repair line from which the FSA is claimed. Additional labor and /or parts require prior approval from the SSSC via the SSSC Web Contact Site.
- Submit refunds on a separate repair line.
 - Program Code: 15M02
 - Misc. Expense: ADMIN
 - Misc. Expense: REFUND
 - Misc. Expense: 0.2 Hrs.
- Multiple refunds should be submitted on one repair line and the invoice details for each repair should be detailed in the comments section of the claim.
- PROGRAM TERMS: This program extends the coverage of the EGT sensors to 11 years of service or 120,000 miles from the warranty start date of the vehicle, whichever occurs first. If a vehicle has already exceeded either the time or mileage limits, this coverage will last through July 31, 2016.
- This program **DOES NOT** apply to vehicles that qualify for repairs under the New Vehicle Limited Warranty. Repairs for vehicles covered by New Vehicle Limited Warranty should be claimed using the Labor Operation Codes provided in TSB 15-0054. If the vehicle is beyond coverage of the New Vehicle Limited Warranty and covered by an Extended Service Plan (ESP), claim repairs to this program (FSA 15M02) instead of the ESP Plan.

Customer Satisfaction Program 15M02
 Certain 2011-2015 Model Year F-Super Duty Vehicles with 6.7L Diesel Engine
 Exhaust Gas Temperature Sensor Extended Coverage

LABOR ALLOWANCES

Description	Labor Operation	Labor Time
Diagnose and replace one EGT sensor	15M02B	0.5 Hours
Diagnose and replace two EGT sensors	15M02C	0.6 Hours
Diagnose and replace three EGT sensors	15M02D	0.8 Hours
Diagnose and replace four EGT sensors	15M02E	0.9 Hours
If required, additional time to remove and install fuel shield to access lifting points (can be claimed with operation B-E)	15M02F	0.1 Hours
If required (FX4 package only), additional time to remove and install fuel shield to access lifting points (can be claimed with operation B-E)	15M02G	0.3 Hours

PARTS REQUIREMENTS / ORDERING INFORMATION

Part Number	Description	Order Quantity
AC3Z-5J213-C	EGT Sensor	Up to 4

The DOR/COR number for this program is 51022.

Order your parts requirements through normal order processing channels.

DEALER PRICE

For latest prices, refer to DOES II.

PARTS RETENTION AND RETURN

Follow the provisions of the Warranty and Policy Manual, Section 1 "WARRANTY PARTS RETENTION AND RETURN POLICIES."

EXCESS STOCK RETURN

Excess stock returned for credit must have been purchased from Ford Customer Service Division in accordance with Policy Procedure Bulletin 4000.

CERTAIN 2011-2015 MODEL YEAR F-SUPER DUTY VEHICLES WITH 6.7L DIESEL ENGINE — EXHAUST GAS TEMPERATURE SENSOR EXTENDED COVERAGE

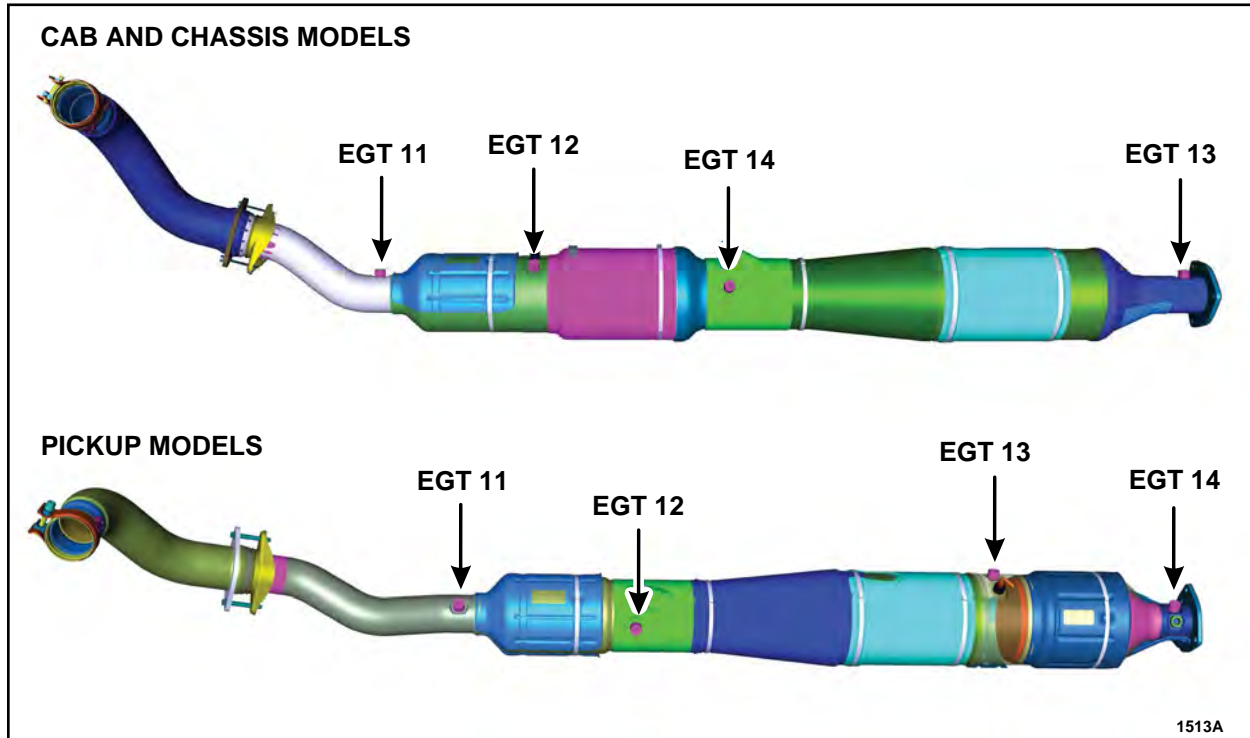

FIGURE 1

SERVICE PROCEDURE

1. Is DTC P0544, P0545, P0546, P06EA, P06EB, P2031, P2032, P2033, P200C, P200E, P2080, P2081, P2084, P2085, P242A, P242B, P242C, P242D, P242E, P246E, P246F, P2470, P2471, P2472, P2478, P2479, P247A and/or P247B present?
 - a. Yes - proceed to Step 2.
 - b. No - this program does not apply. Refer to Powertrain Controls and Emissions Diagnostics (PC/ED) Manual for normal diagnostics as required.
2. Based on the DTCs retrieved in Step 1, replace the corresponding Exhaust Gas Temperature (EGT) sensor(s) as instructed below. Please refer to the Workshop Manual (WSM), Section 303-14, Engine Control Components for EGT sensor locations and replacement procedure.
 - DTCs P0544, P0545, P0546, P2080, P2081, P2478 replace EGT-11.
 - DTCs P2031, P2032, P2033, P2084, P2085, P2479 replace EGT-12.
 - DTCs P242A, P242B, P242C, P242D, P242E, P247A replace EGT-13.
 - DTCs P246E, P246F, P2470, P2471, P2472, P247B replace EGT-14.
 - DTCs P06EA, P06EB, P200C and/or P200E, proceed to Step 3.



3. Is DTC P200C and/or P200E stored in PCM memory with no other EGT DTCs present?
 - a. Yes - proceed to Step 4.
 - b. No - proceed to Step 5.

4. Use Integrated Diagnostic System (IDS) freeze frame data readings to confirm when DTC P200C and/or P200E were set. Replace the corresponding EGT sensor as instructed below. Please refer to the WSM, Section 303-14, Engine Control Components for EGT sensor locations and replacement procedure.
 - If EGT-12 temperature is 650 °C (1202 °F) greater than EGT-11 temperature, replace EGT-12.
 - If EGT-13 temperature is above 900 °C (1652 °F), replace EGT-13.
 - If IDS freeze frame data shows EGT-13 temperature is 650 °C (1202 °F) greater than EGT-12 temperature, replace EGT-13.
 - If EGT-14 temperature is above 900 °C (1652 °F) replace EGT-14.
 - If IDS freeze frame data shows EGT14 temperature is 650 °C (1202 °F) greater than EGT-13 temperature replace EGT-14.

5. Based on the DTCs retrieved in Step 1, replace the corresponding EGT sensor(s) as instructed below. Refer to the WSM, Section 303-14, Engine Control Components for EGT sensor locations and replacement procedure.
 - DTC P06EA:
 - 2011-2012 pickups replace EGT14.
 - 2011-2012 chassis cabs replace EGT13.
 - DTC P06EA on all 2013-2015 F-Super Duty models replace EGT12.
 - DTC P06EB replace EGT-14.





Michael A. Berardi
Director
Service Engineering Operations
Ford Customer Service Division

Ford Motor Company
P. O. Box 1904
Dearborn, Michigan 48121

January 21, 2016

TO: All U.S. Ford and Lincoln Dealers

SUBJECT: DEMONSTRATION / DELIVERY HOLD - Customer Satisfaction Program 15B39
Certain 2015 Model Year Transit Vehicles
Under Hood Water Management Repair

PROGRAM TERMS

This program will be in effect through December 31, 2016. There is no mileage limit for this program.

AFFECTED VEHICLES

Vehicle	Model Year	Assembly Plant	Build Dates
Transit	2015	Kansas City	January 17, 2014 through March 30, 2015

Affected vehicles are identified in OASIS and FSA VIN Lists.

REASON FOR THIS PROGRAM

In some of the affected vehicles, insufficient sealing in certain areas of the engine compartment may allow undesired water entry into the engine compartment directly over powertrain components. This can lead to symptoms including difficulty starting, misfires, or illumination of the Malfunction Indicator Lamp (MIL).

SERVICE ACTION

Before demonstrating or delivering any of the vehicles involved in this program, dealers are to install water management measures. This service must be performed on all affected vehicles at no charge to the vehicle owner.

OWNER NOTIFICATION MAILING SCHEDULE

Owner Letters are expected to be mailed the week of February 1, 2016. Dealers should repair any affected vehicles that arrive at their dealerships, whether or not the customer has received a letter.

ATTACHMENTS

Attachment I: Administrative Information
Attachment II: Labor Allowances and Parts Ordering Information
Attachment III: Technical Information
Owner Notification Letter

QUESTIONS & ASSISTANCE

For questions and assistance, contact the Special Service Support Center (SSSC) via the SSSC Web Contact Site. The SSSC Web Contact Site can be accessed through the Professional Technician Society (PTS) website using the SSSC link listed at the bottom of the OASIS VIN report screen or listed under the SSSC tab.

Sincerely,

Michael A. Berardi

DEMONSTRATION / DELIVERY HOLD - Customer Satisfaction Program 15B39

Certain 2015 Model Year Transit Vehicles

Under Hood Water Management Repair

OASIS ACTIVATION

OASIS will be activated on January 21, 2016.

FSA VIN LISTS ACTIVATION

FSA VIN Lists will be available through <https://web.fsavinlists.dealerconnection.com> on January 21, 2016. Owner names and addresses will be available by February 11, 2016.

NOTE: Your FSA VIN Lists may contain owner names and addresses obtained from motor vehicle registration records. The use of such motor vehicle registration data for any purpose other than in connection with this program is a violation of law in several states, provinces, and countries. Accordingly, you must limit the use of this listing to the follow-up necessary to complete this service action.

STOCK VEHICLES

- Correct all affected units in your new vehicle inventory before delivery.
- Use OASIS to identify any affected vehicles in your used vehicle inventory.

SOLD VEHICLES

- Owners of affected vehicles will be directed to dealers for repairs.
- Immediately contact any of your affected customers whose vehicles are not on your VIN list but are identified in OASIS. Give the customer a copy of the Owner Notification Letter (when available) and schedule a service date.
- Correct other affected vehicles identified in OASIS which are brought to your dealership.

TITLE BRANDED / SALVAGED VEHICLES

Affected title branded and salvaged vehicles are eligible for this service action.

ADDITIONAL LABOR TIME AND/OR PARTS

Submit a request to the SSSC Web Contact Site prior to the repair if you have any of the following:

- Damage that you believe was caused by the covered condition.
- A condition that requires additional labor and/or parts to complete the repair.
- Aftermarket equipment or non-Ford modifications to the vehicle which might prevent the repair of the covered condition.

Requests for approval after completion of the repair may not be granted. Ford Motor Company reserves the right to deny coverage for related damage in cases where the vehicle owner has not had this recall performed on a timely basis. Additional related damage parts are subject to random selection for return to the Ford Warranty Parts Analysis Center (WPAC).

DEMONSTRATION / DELIVERY HOLD - Customer Satisfaction Program 15B39

Certain 2015 Model Year Transit Vehicles

Under Hood Water Management Repair

OWNER REFUNDS

- Ford Motor Company is offering a refund for owner-paid repairs covered by this program if the repair was performed before the date of the Owner Notification Letter. This refund offer expires June 30, 2016.
- Dealers are also pre-approved to refund owner-paid emergency repairs that were performed away from an authorized servicing dealer after the date of the Owner Notification Letter. There is no expiration date for emergency repair refunds. Non-covered repairs, or those judged by Ford to be excessive, will not be reimbursed.
- Refunds will only be provided for the cost associated with repairs related to water intrusion into the engine compartment.

RENTAL VEHICLES

The use of rental vehicles is not approved for this program.

CLAIMS PREPARATION AND SUBMISSION

- Enter claims using Direct Warranty Entry (DWE) or One Warranty Solution (OWS).
 - DWE: refer to ACESII manual for claims preparation and submission information.
 - OWS: when entering claims in DMS software, select claim type 31: Field Service Action. The FSA number (15B39) is the sub code.
- Additional labor and/or parts must be claimed as related damage on a separate repair line from which the FSA is claimed. Additional labor and/or parts require prior approval from the SSSC via the SSSC Web Contact Site.
- Submit refunds on a separate repair line.
 - Program Code: 15B39
 - Misc. Expense: REFUND
 - Misc. Expense: ADMIN
 - Misc. Expense: 0.2 Hrs.
- Multiple refunds should be submitted on one repair line and the invoice details for each repair should be detailed in the comments section of the claim.
- PROGRAM TERMS: This program will be in effect through December 31, 2016. There is no mileage limit for this program.

DEMONSTRATION / DELIVERY HOLD - Customer Satisfaction Program 15B39

Certain 2015 Model Year Transit Vehicles

Under Hood Water Management Repair

LABOR ALLOWANCES

Description	Labor Operation	Labor Time
Install Water Management Measures	15B39B	0.8 Hours

PARTS REQUIREMENTS / ORDERING INFORMATION

Part Number	Description	Order Quantity
CK4Z-6102408-AA	Water Diverter	1
CK4Z-9601-A	Air Filter (if required)	1
CK4Z-61021A46-A	Leaf Screen Foam Seal	1
4L3Z-18203A16-AA	Mastic Patch (1 patch will service approximately 4 vehicles)	1
ZC-31-B	Motorcraft® Metal Surface Prep Wipes (1 wipe per vehicle)	1
CK4Z-17C582-A	Wiper Arm Grommet (low roof vehicles only)	1

The DOR/COR number for this program is 51023.

Order your parts requirements through normal order processing channels. To guarantee the shortest delivery time, an emergency order for parts must be placed.

DEALER PRICE

For latest prices, refer to DOES II.

PARTS RETENTION AND RETURN

Follow the provisions of the Warranty and Policy Manual, Section 1 "WARRANTY PARTS RETENTION AND RETURN POLICIES."

EXCESS STOCK RETURN

Excess stock returned for credit must have been purchased from Ford Customer Service Division in accordance with Policy Procedure Bulletin 4000.

CERTAIN 2015 MODEL YEAR TRANSIT VEHICLES — UNDER HOOD WATER MANAGEMENT REPAIR

OVERVIEW

In some of the affected vehicles, insufficient sealing in certain areas of the engine compartment may allow undesired water entry into the engine compartment directly over powertrain components. This can lead to symptoms including difficulty starting, misfires, or illumination of the Malfunction Indicator Lamp (MIL). Dealers are to install water management measures.

SERVICE PROCEDURE

All Vehicles

1. Remove the cowl panel grille. Please follow the Workshop Manual (WSM) procedures in Section 501-02.
2. Clean the back of the cowl panel grille with a clean cloth. See Figure 1.



FIGURE 1

3. Apply the leaf screen foam seal along the back of the cowl panel grille. See Figure 2.

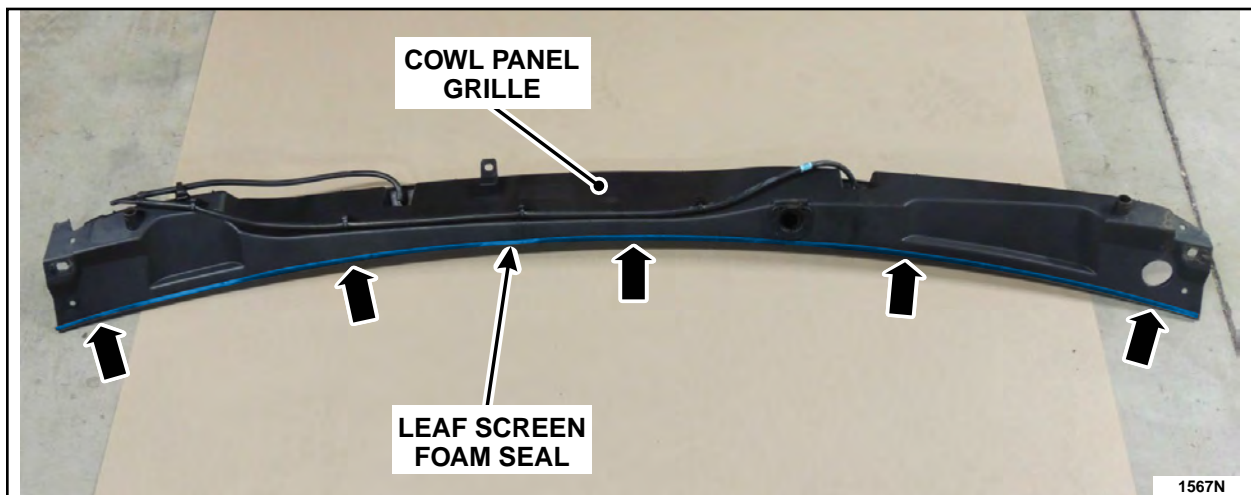

FIGURE 2



4. Remove and discard the drain hose from the passenger side of the cowl panel grille. See Figure 3.

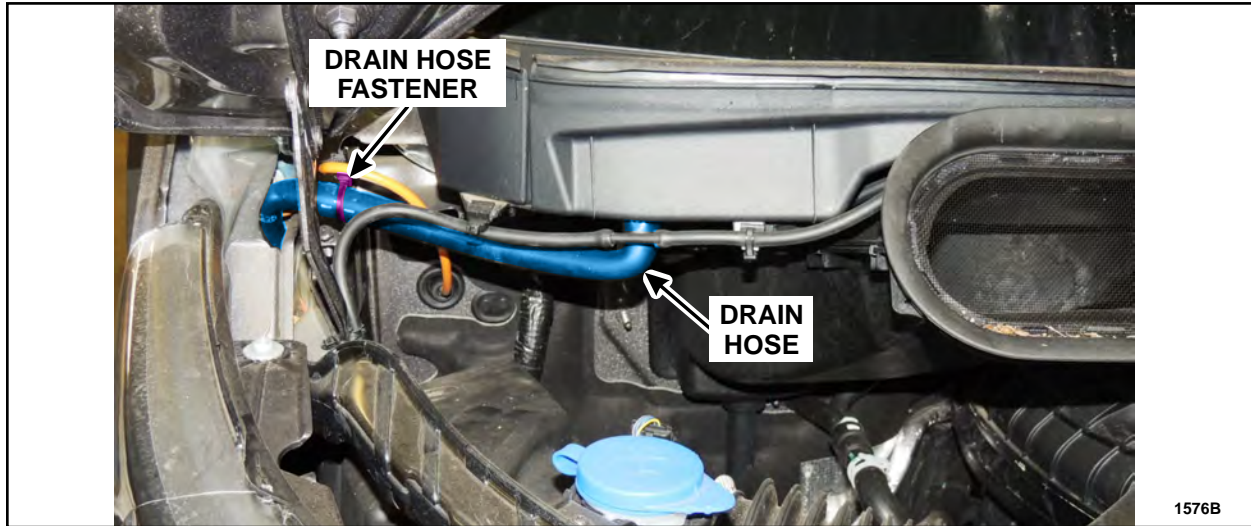

FIGURE 3

5. Remove the bolt and position aside the windshield washer reservoir filler neck. See Figure 4.

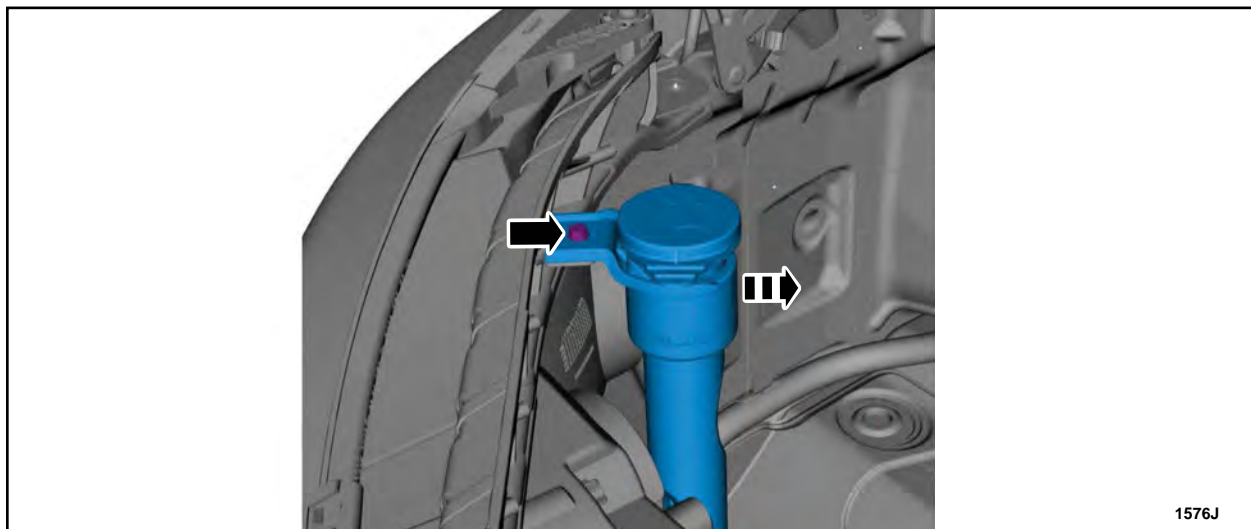

FIGURE 4



6. Loosen the clamp and disconnect the air filter outlet pipe from the air filter cover. See Figure 5.

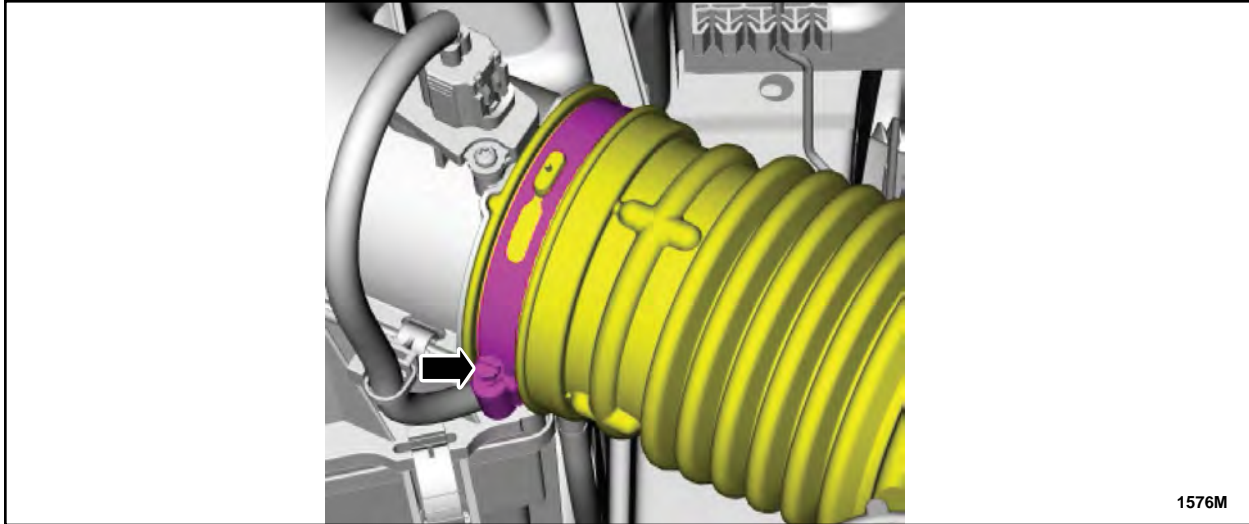

FIGURE 5

7. Disconnect the electrical connector and detach the wiring harness retainer from the air filter cover. See Figure 6.

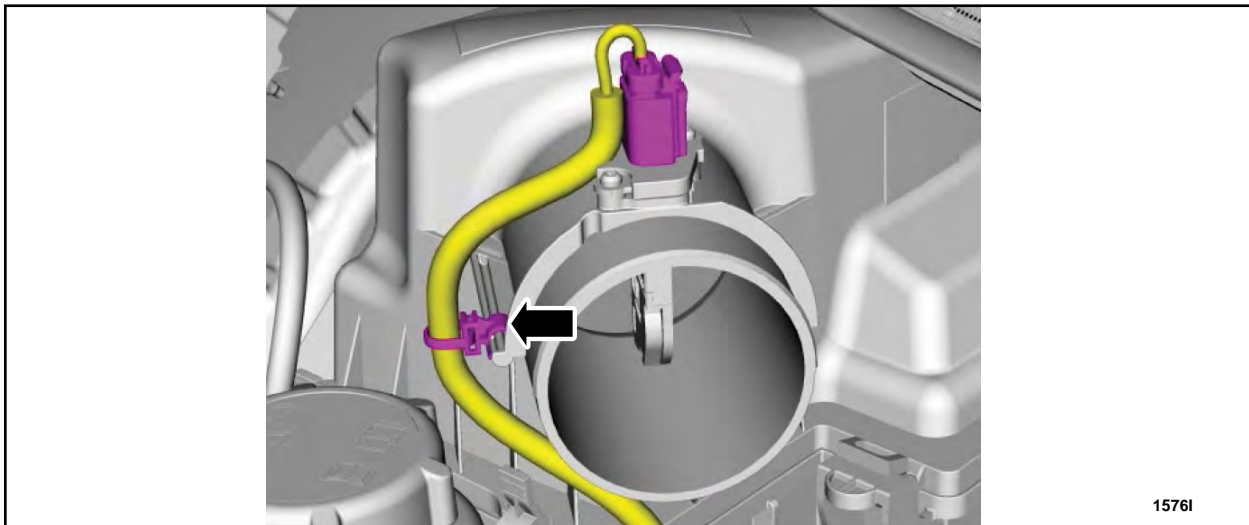

FIGURE 6



8. Unclip and remove the air filter cover. See Figure 7.

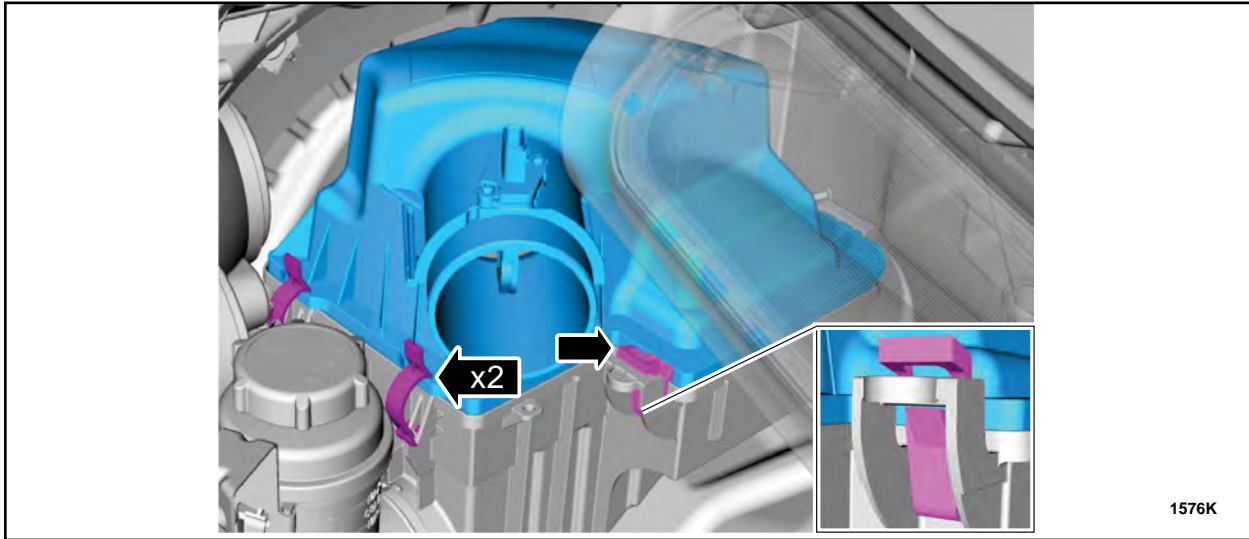

FIGURE 7

9. Remove the air filter. See Figure 8.

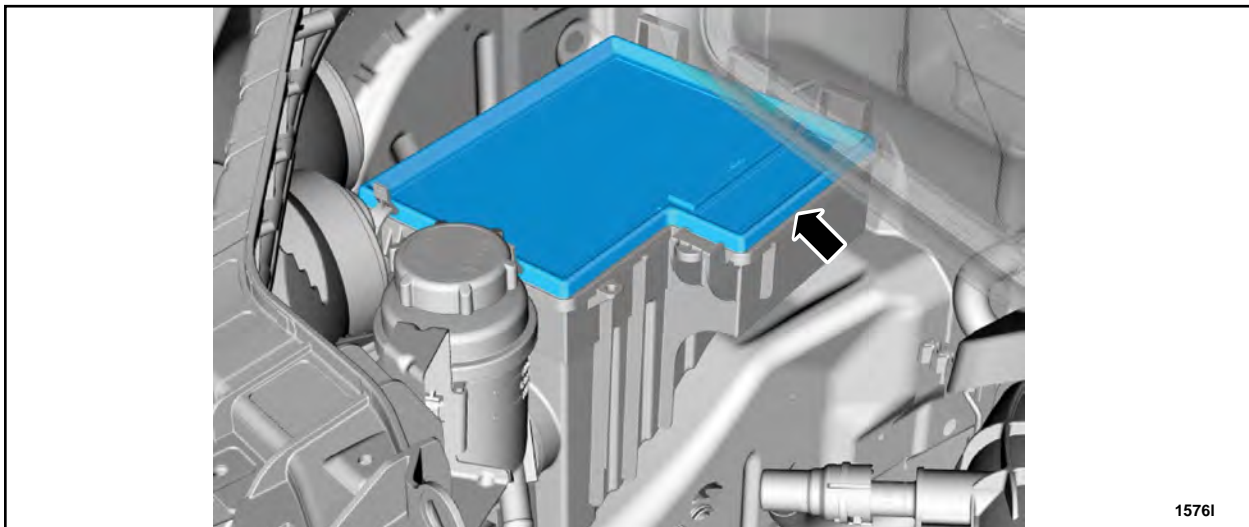

FIGURE 8



10. Clean the body joint between the right inner fender and dash panel with a Motorcraft® Metal Surface Prep Wipe or equivalent. See Figure 9.

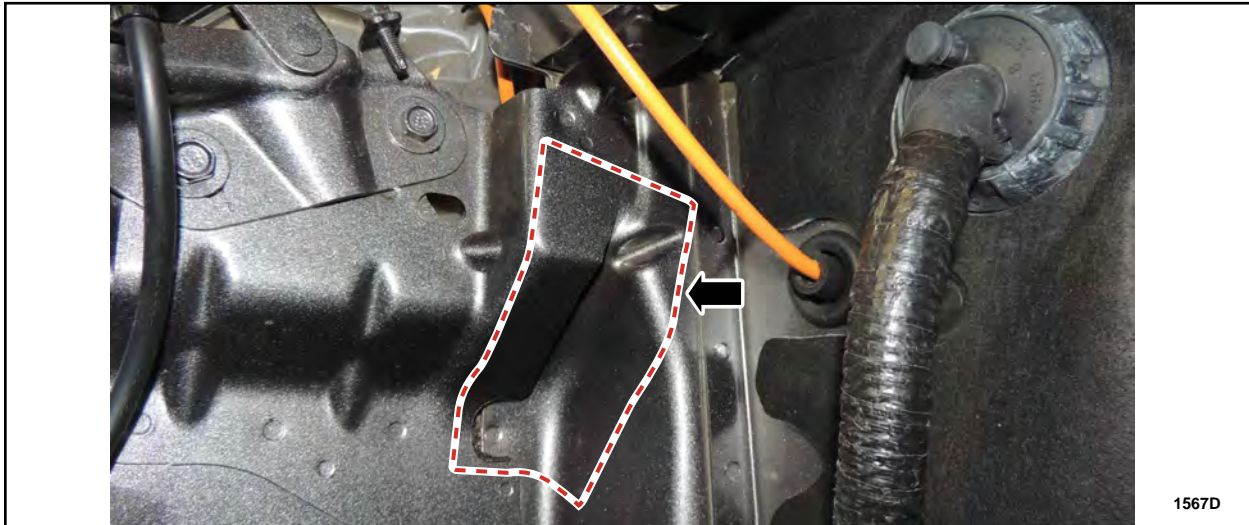

FIGURE 9

NOTE: The supplied mastic patch will service approximately four vehicles.

11. Cut the supplied mastic patch to 8 cm x 13 cm (3 in x 5 in) and apply the patch to the body joint. See Figure 10.

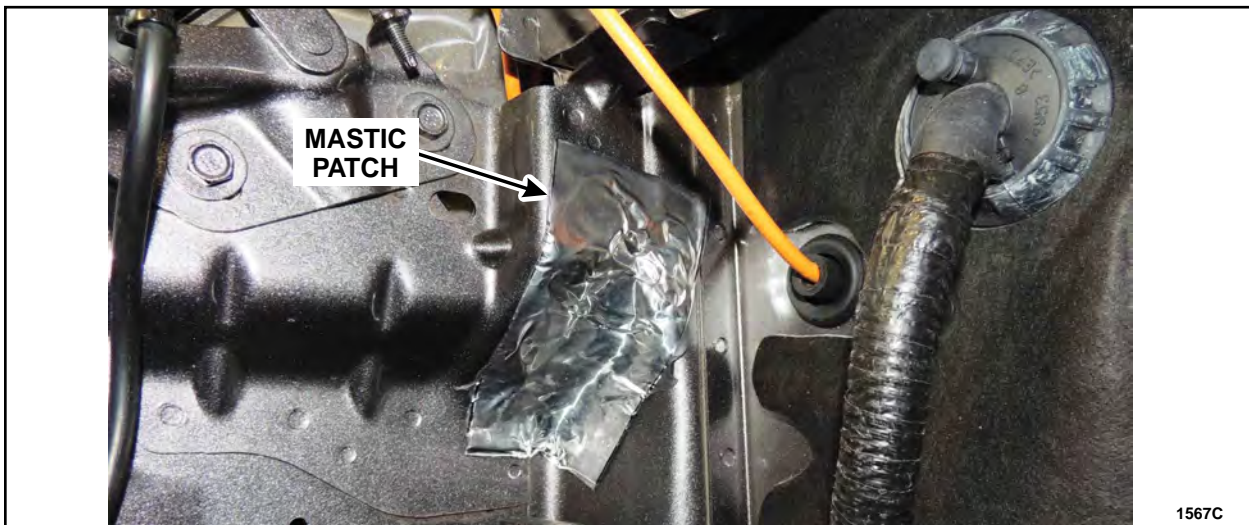

FIGURE 10



12. Inspect the air filter to determine if it is dry/damp or saturated with water or ice.
 - If - Dry/damp - Clean any debris from the air filter tray and reinstall the air filter.
Normal engine operation will dry the filter if damp.
 - If - Saturated with water or ice - Install a *new* air filter.
13. Install the air filter cover and fasten the clips. See Figure 7.
14. Connect the electrical connector and attach the wiring harness retainer to the air filter cover. See Figure 6.
15. Connect the air filter outlet pipe to the air filter cover and tighten the clamp. See Figure 5.
 - Tighten to 35 lb.in (4 Nm).
16. Reposition the windshield washer reservoir filler neck and install the bolt. See Figure 4.
 - Tighten to 71 lb.in (8 Nm).

Low Roof Vehicles Only

17. Replace the passenger side windshield wiper arm grommet on the cowl panel grille. See Figure 11.

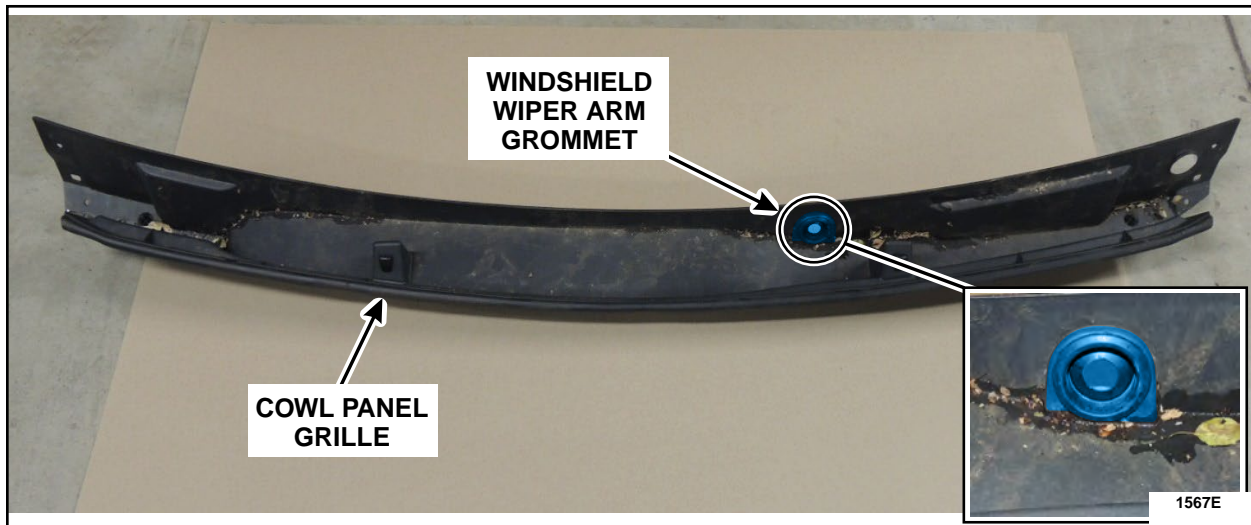

FIGURE 11



All Vehicles

18. Reinstall the cowl panel grille. Please follow the WSM procedures in Section 501-02.
19. Install the supplied water diverter on the passenger side of the vehicle. See Figure 12.
 - a. Install the outboard end of the diverter into the sheet metal tab behind the hood hinge.
 - b. Snap the diverter up onto the cowl panel grille.

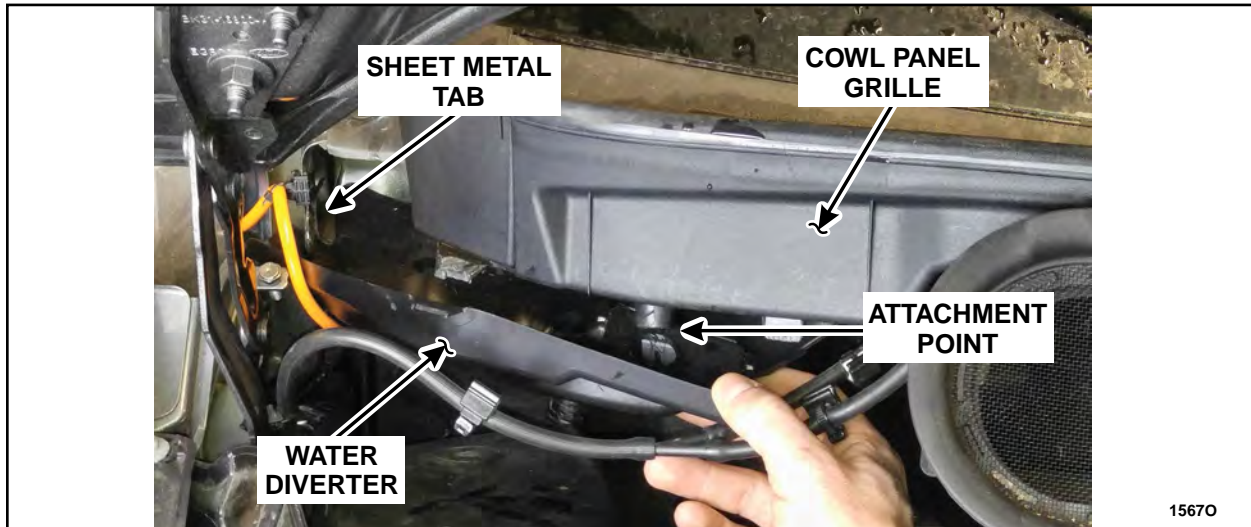

FIGURE 12

20. Route the orange antenna wire in front of the diverter and route the washer hose under the inboard end of the diverter. Attach the washer hose clip to the front edge of the diverter. See Figure 13.

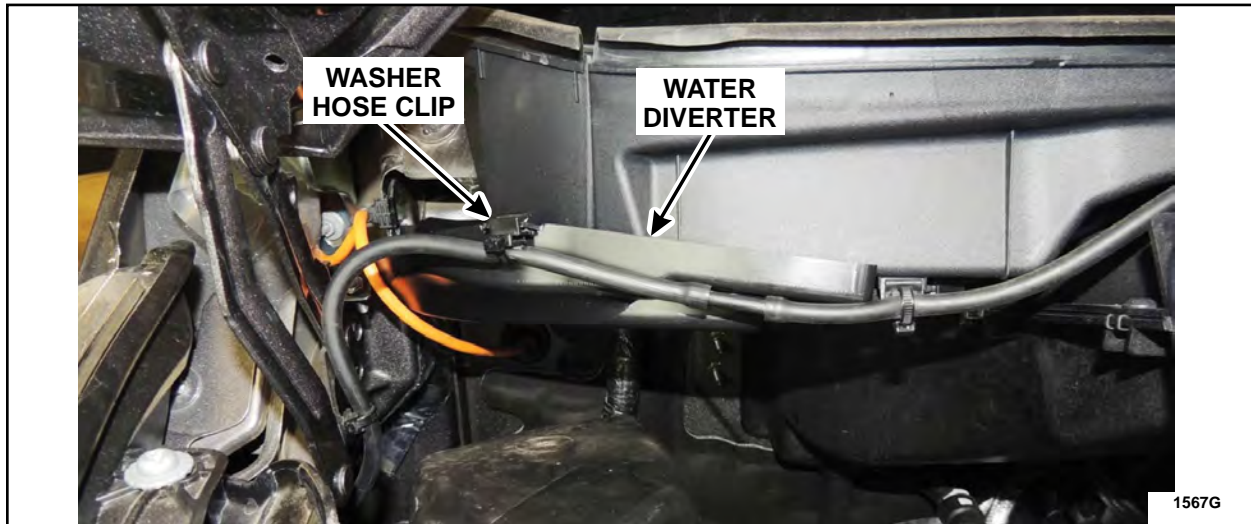

FIGURE 13





Ford Motor Company
Ford Customer Service Division
P. O. Box 1904
Dearborn, Michigan 48121

February 2016

Customer Satisfaction Program 15B39
Programa de satisfacción del cliente 15B39

Mr. John Sample
123 Main Street
Anywhere, USA 12345

Your Vehicle Identification Number (VIN): 12345678901234567

At Ford Motor Company, we are committed not only to building high quality, dependable products, but also to building a community of happy, satisfied customers. To demonstrate that commitment, we are providing a no-charge Customer Satisfaction Program for your vehicle with the VIN shown above.

Why are you receiving this notice?



MIL

On your vehicle, insufficient sealing in certain areas of the engine compartment may allow undesired water entry into the engine compartment directly over powertrain components. This can lead to symptoms including difficulty starting, misfires, or illumination of the Malfunction Indicator Lamp (MIL), which is shown to the left.

What will Ford and your dealer do?

In the interest of customer satisfaction, Ford Motor Company has authorized your dealer to install water management measures on your vehicle free of charge (parts and labor) under the terms of this program. This Customer Satisfaction Program will be in effect until December 31, 2016 regardless of mileage. Coverage is automatically transferred to subsequent owners.

How long will it take?

The time needed for this repair is less than one-half day. However, due to service scheduling requirements, your dealer may need your vehicle for a longer period of time.

What should you do?

Please call your dealer without delay and request a service date for Customer Satisfaction Program 15B39. Provide the dealer with the VIN of your vehicle, which is printed near your name at the beginning of this letter. If you do not already have a servicing dealer, you can access www.Fordowner.com for dealer addresses, maps, and driving instructions. Ford Motor Company wants you to have this service action completed on your vehicle. The vehicle owner is responsible for making arrangements to have the work completed. Ford Motor Company can deny coverage for any vehicle damage that may result from the failure to have this service action performed on a timely basis. Therefore, please have this service action performed as soon as possible.

Have you previously paid for this repair?

If you have previously paid for a repair that addresses the issue described in this letter, you still need to have this service action performed to ensure the correct parts and procedures were used.

If the previously paid for repair was performed before the date of this letter, you may be eligible for a refund. Refunds will only be provided for service related to repairs caused by water intrusion into the engine compartment. To verify eligibility and expedite reimbursement, give your paid original receipt to your dealer before June 30, 2016. To avoid delays, do not send receipts to Ford Motor Company.

What if you no longer own this vehicle?

If you no longer own this vehicle, and have an address for the current owner, please forward this letter to the new owner.

You received this notice because our records, which are based primarily on state registration and title data, indicate that you are the current owner.

Can we assist you further?

If you have difficulties getting your vehicle repaired promptly and without charge, please contact your dealership's Service Manager for assistance.

RETAIL OWNERS: If you still have concerns, please contact the Ford Motor Company Customer Relationship Center at 1-866-436-7332 and one of our representatives will be happy to assist you. For the hearing impaired call 1-800-232-5952 (TDD). Representatives are available Monday through Friday: 8:00AM – 8:00PM (Eastern Time).

If you wish to contact us through the Internet, our address is:

www.Fordowner.com.

Si necesita ayuda o tiene alguna pregunta, por favor llame al Centro de Relación con Clientes al 1-866-436-7332 y presione 2 para Español.

FLEET OWNERS: If you still have concerns, please contact the Fleet Customer Information Center at 1-800-34-FLEET, Option #3 and one of our representatives will be happy to assist you. Representatives are available Monday through Friday: 8:00AM - 8:00PM (Eastern Time).

Or you may contact us through the Internet at www.fleet.ford.com.

MOTORHOME OWNERS: If you still have concerns, please contact the Motorhome Customer Assistance Center toll free at 1-866-906-9811. Representatives are available 24 hours a day.

Thank you for your attention to this important matter.

Ford Customer Service Division



Michael A. Berardi
Director
Service Engineering Operations
Ford Customer Service Division

Ford Motor Company
P. O. Box 1904
Dearborn, Michigan 48121

January 27, 2016

TO: All U.S. Ford and Lincoln Dealers

SUBJECT: Customer Satisfaction Program 15N04

Certain 2015 Model Year MKC and MKZ Vehicles Equipped with the Reserve Equipment Group
Embedded Modem Replacement

PROGRAM TERMS

This program provides coverage to upgrade the embedded modem to prevent the loss of MyLincoln Mobile service. This is a one-time repair program. Coverage extends to five years of service from the warranty start date of the vehicle, regardless of mileage. Coverage is automatically transferred to subsequent owners.

VEHICLES COVERED BY THIS PROGRAM

Vehicle	Model Year	Assembly Plant	Build Dates
MKC with Reserve Equipment Group	2015	Louisville	November 12, 2013 through June 15, 2015
MKZ with Reserve Equipment Group	2015	Hermosillo	February 21, 2014 through March 29, 2015

Affected vehicles are identified in OASIS.

REASON FOR PROVIDING EXTENDED WARRANTY COVERAGE

Owners of all affected vehicles received a complimentary subscription to the MyLincoln Mobile service. This service uses an embedded modem that operates on a cellular network that is being decommissioned. As the network is decommissioned, customers who actively use the MyLincoln Mobile service will experience a loss of wireless connectivity with their vehicles. This concern will not impact control or performance of the vehicle.

While customers who do not currently use the MyLincoln Mobile service will not notice the effects of the cellular network shutdown, if they choose to activate their service in the future, it will not function with the existing embedded modem.

SERVICE ACTION

Dealers should ensure that customers are aware of the impending loss of MyLincoln Mobile service.

If a customer requests the embedded modem upgrade, dealers are to replace the embedded modem with an updated part that operates on a different cellular network. This service must be performed at no charge to the vehicle owner.

NOTE: If a customer would like more information about the MyLincoln Mobile service, or would like to activate their service and take advantage of this program, additional information can be found on the Lincoln Owner web site. Navigate to www.Lincolnowner.com then select "SYNC & How-Tos," "Vehicle Features," then "Remote Features."

OWNER NOTIFICATION MAILING SCHEDULE

Owner Letters are expected to be mailed the week of February 15, 2016. Dealers should upgrade the embedded modem at the customer's request, whether or not the customer has received a letter.

ATTACHMENTS

Attachment I: Administrative Information
Attachment II: Labor Allowances and Parts Ordering Information
Attachment III: Technical Information
Owner Notification Letter

QUESTIONS & ASSISTANCE

For questions and assistance, contact the Special Service Support Center (SSSC) via the SSSC Web Contact Site. The SSSC Web Contact Site can be accessed through the Professional Technician Society (PTS) website using the SSSC link listed at the bottom of the OASIS VIN report screen or listed under the SSSC tab.

Sincerely,



Michael A. Berardi

Customer Satisfaction Program 15N04

Certain 2015 Model Year MKC and MKZ Vehicles Equipped with the Reserve Equipment Group
Embedded Modem Replacement

OASIS ACTIVATION

OASIS will be activated on January 27, 2016.

FSA VIN LISTS ACTIVATION

FSA VIN Lists will not be activated for this service action.

STOCK VEHICLES

Do not perform this service unless the customer requests repairs covered by this program.

SOLD VEHICLES

Owners of all affected vehicles will be directed to dealers for repairs if they wish to prevent the loss of MyLincoln Mobile service.

VEHICLES WITH CANCELLED WARRANTIES

Vehicles with cancelled warranties are not eligible for this service action.

ADDITIONAL REPAIR (LABOR TIME AND/OR PARTS)

Additional repairs identified as necessary to complete the FSA should be managed as follows:

- For vehicles within new vehicle bumper-to-bumper warranty coverage, follow existing warranty and policy guidelines for related damage claims. No SSSC approval is required for these vehicles:
 - Ford vehicles – 3 years or 36,000 miles
 - Lincoln vehicles – 4 years or 50,000 miles
- For vehicles outside new vehicle bumper-to-bumper warranty coverage, submit an Approval Request to the SSSC Web Contact Site prior to completing the repair.

OWNER REFUNDS

Refunds are not approved for this program.

RENTAL VEHICLES

The use of rental vehicles is not approved for this program.

LINCOLN CLIENT SPECIAL HANDLING

To ensure the best possible experience for Lincoln owners, Lincoln Dealers are encouraged to utilize the Lincoln Loyalty Program to provide clients with surprise and delight offerings, including:

- Fuel fill
- Transportation assistance
- Courtesy pick-up and delivery of client vehicles

The Lincoln Loyalty Program is exclusive to Lincoln Dealers. Owners will not be notified of this service in owner mailings. Reference EFC03578, Lincoln Loyalty Program Announcement for additional details.

Customer Satisfaction Program 15N04

Certain 2015 Model Year MKC and MKZ Vehicles Equipped with the Reserve Equipment Group
Embedded Modem Replacement

CLAIMS PREPARATION AND SUBMISSION

- This is a one-time repair program and also applies to vehicles that are within the New Vehicle Limited Warranty coverage period. Repairs should be claimed against Program Code 15N04.
- Enter claims using Direct Warranty Entry (DWE) or One Warranty Solution (OWS).
 - DWE: refer to ACESII manual for claims preparation and submission information.
 - OWS: when entering claims in DMS software, select claim type 31: Field Service Action. The FSA number (15N04) is the sub code.
- Additional labor and/or parts must be claimed as related damage on a separate repair line from the FSA.
- Telematics Control Units (TCUs)/embedded modems will be supplied by Ford Component Sales (FCS). No parts cost will be incurred by dealers, and dealers should not include parts cost on claims.
- For Lincoln Client Special Handling, reference EFC03578, Lincoln Loyalty Program Announcement and EFC04165, Lincoln Loyalty Rental Claims for Requirements and Claiming Instructions. Claims for Lincoln Loyalty should be submitted as a separate line on the same Repair Order.

Customer Satisfaction Program 15N04

Certain 2015 Model Year MKC and MKZ Vehicles Equipped with the Reserve Equipment Group
Embedded Modem Replacement

LABOR ALLOWANCES

Description	Labor Operation	Labor Time
Replace Telematics Control Unit (TCU)/embedded modem	15N04B	0.5 Hours

PARTS REQUIREMENTS / ORDERING INFORMATION

The TCU/embedded modem should be ordered using the On-line 1878 form.

To order an embedded modem:

- Go to FMCDealer.com
- Go to OASIS, enter the VIN and click GO
- Scroll to the bottom and select the On-Line 1878
- Select Telematics Control Unit (TCU) from the System drop-down box
- Complete the On-line 1878 Ford order process, selecting 15N04 as the claim submission type

Part Number	Description	Order Quantity
EJ7Z-19A387-B	Telematics Control Unit (TCU)/embedded modem – MKC	1
GP5Z-19A387-B	Telematics Control Unit (TCU)/embedded modem – MKZ	1

For questions regarding parts, submit a request through the On-Line 1878 Form by clicking the Help/Feedback/Contacts link near the bottom of the page.

DEALER PRICE

Embedded modems will be supplied by Ford Component Sales (FCS), and parts costs will not be incurred by the dealer.

PARTS RETENTION AND RETURN

Follow the provisions of the Warranty and Policy Manual, Section 1 “WARRANTY PARTS RETENTION AND RETURN POLICIES.”

CERTAIN 2015 MODEL YEAR MKC AND MKZ VEHICLES EQUIPPED WITH THE RESERVE EQUIPMENT GROUP — EMBEDDED MODEM REPLACEMENT

OVERVIEW

Owners of all affected vehicles received a complimentary subscription to the MyLincoln Mobile service. This service uses an embedded modem that operates on a cellular network that is being decommissioned. As the network is decommissioned, customers who actively use the MyLincoln Mobile service will experience a loss of wireless connectivity with their vehicles. This concern will not impact control or performance of the vehicle. If a customer requests the embedded modem upgrade, dealers are to replace the embedded modem with an updated part that operates on a different cellular network.

SERVICE PROCEDURE

MKZ Vehicles

NOTE: Use IDS release 98.03 or later for Programmable Module Installation (PMI). When prompted to select automatic or manual process for As-Built data, select automatic.

1. Replace the Telematics Control Unit (TCU)/embedded modem. Please follow Workshop Manual (WSM) procedures in Section 415-00.

NOTE: If the customer has an active MyLincoln Mobile account, a message will appear in the touch screen display after installation and configuration of the replacement TCU requesting approval for owner access. Before selecting "Allow," confirm with the customer that the email address shown in the message is correct for their MyLincoln Mobile account.

NOTE: For more information on MyLincoln Mobile service, go to www.Lincolnowner.com, then select "SYNC & How-Tos," "Vehicle Features," then "Remote Features."



MKC Vehicles

1. Using Integrated Diagnostic System (IDS) release 98.03 or later, begin the Programmable Module Installation (PMI) process for the Telematics Control Unit (TCU)/embedded modem following the on-screen instructions.
2. Remove the RH lower floor console trim panel. See Figure 1.

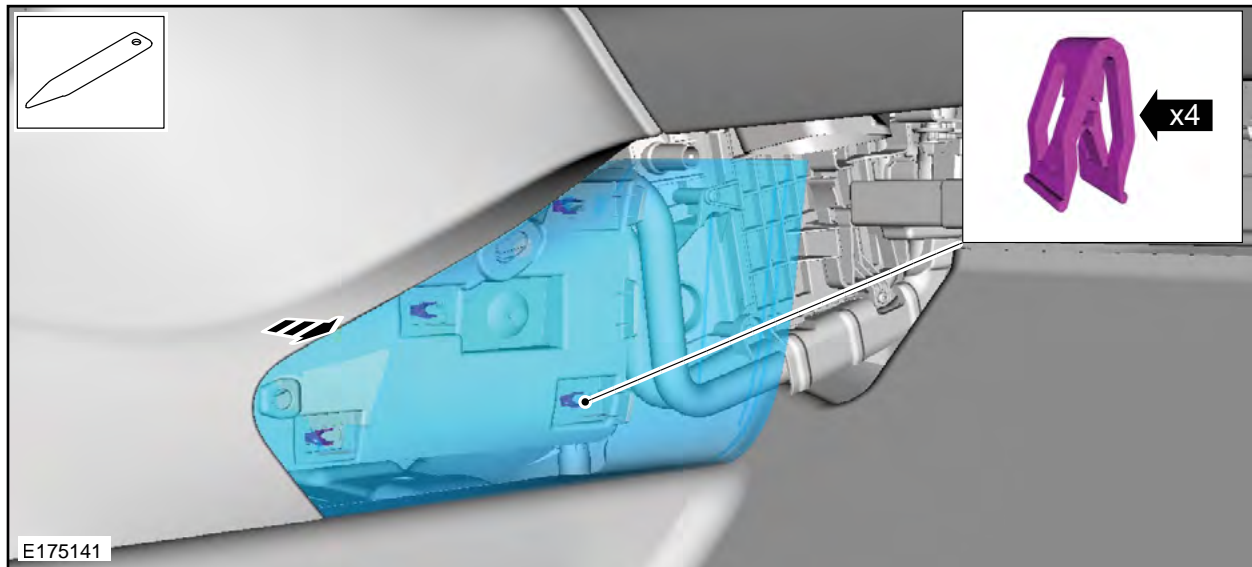

FIGURE 1



3. Remove and discard the TCU. See Figure 2.

- a. Remove the two TCU bolts.
- b. Disconnect the electrical connector and remove the TCU.

NOTE: Trim panels and carpet removed for clarity.

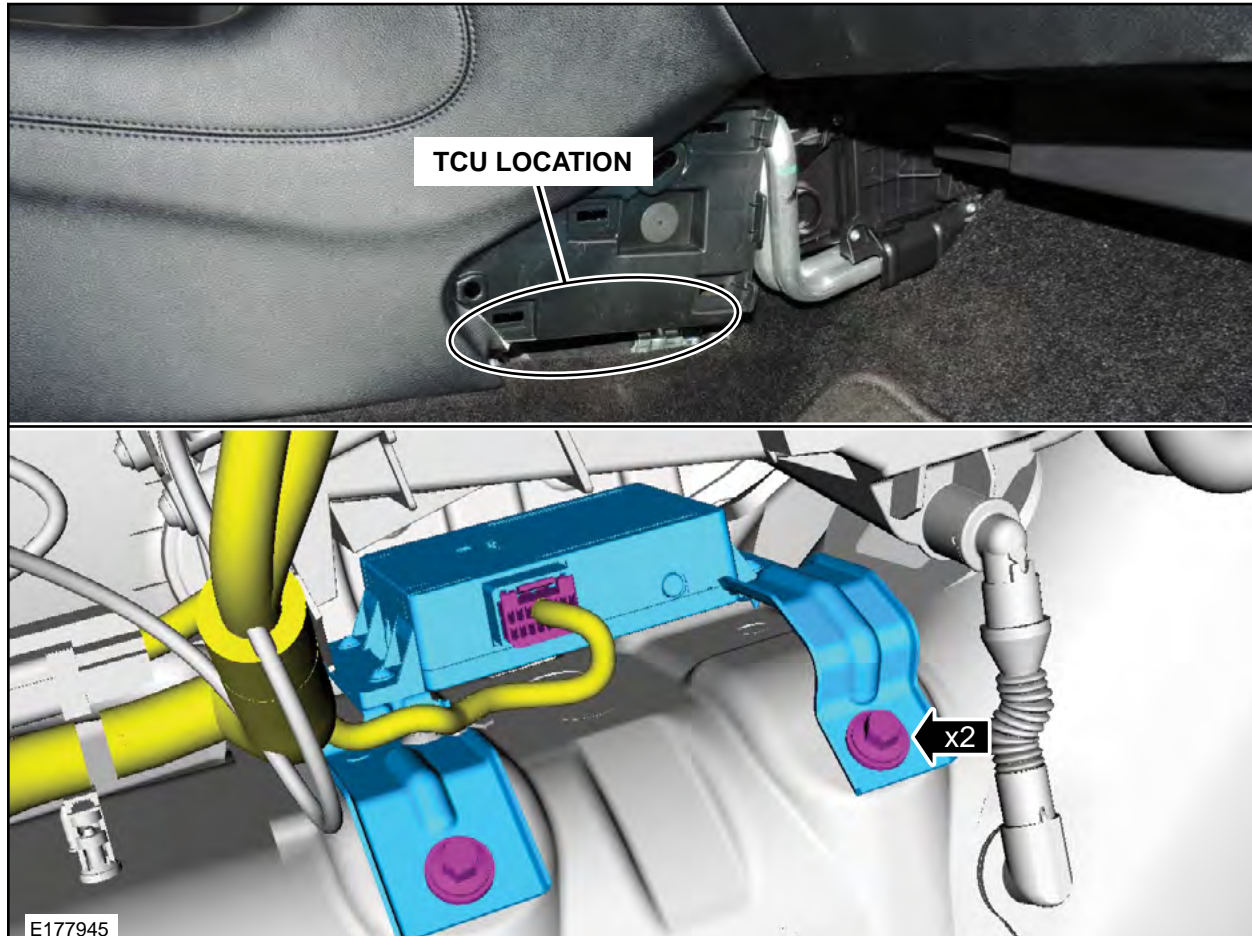

FIGURE 2

4. Install the new TCU by reversing the removal procedure.

- Torque the TCU bolts to 30 lb.ft (40 Nm).

5. Install the RH lower floor console trim panel. See Figure 1.

NOTE: When prompted to select automatic or manual process for As-Built data, select automatic.

6. Using the IDS, complete the PMI process for the TCU following the on-screen instructions.



NOTE: If the customer has an active MyLincoln Mobile account, a message will appear in the touch screen display after installation and configuration of the replacement TCU requesting approval for owner access. Before selecting "Allow," confirm with the customer that the email address shown in the message is correct for their MyLincoln Mobile account.

NOTE: For more information on MyLincoln Mobile service, go to www.Lincolnowner.com, then select "SYNC & How-Tos," "Vehicle Features," then "Remote Features."



ONLINE AUTOMOTIVE SERVICE INFORMATION SYSTEM FOR JANUARY 2016

45568	Some 2013-2016 Fusion/MKZ vehicles may exhibit a gurgle-type noise from the center of the dash at idle when the A/C is on and the blower motor is on the lowest setting. Prior to performing any repairs, compare the noise to a like unit. A certain amount of noise is characteristic of the thermostatic expansion valve A/C system.
45569	Some 2015-2016 Transit equipped with a 3.5L or 3.7L that are not equipped with a tow/haul button can set P1780 after performing a KOER test. In these cases, clear the code and no additional action is required as there is no tow/haul button to toggle during the test.
45575	Some 2015-2016 F-150 vehicles may exhibit a trailer connected then trailer disconnected and/or a trailer battery not charging message displayed in the message center when no trailer is being used. To correct the concern, reprogram the Trailer Module (TRM) to the latest calibration using IDS version 98.04 or higher. Make sure you are connected to the internet when entering module programming to obtain the latest updates. Calibration files may also be obtained at www.motorcraftservice.com . Use causal component 19H332 and applicable 12651D labor operations from Section 10 of the Service Labor Times Standards manual for reprogram only.
45577	2013-2016 Escape - The option for hands free liftgate function with trailer tow package was added to Escape vehicles built on or after 12/1/2013. If a vehicle is built with trailer tow but not hands free liftgate, it cannot be added. Also, if a customer tries to add a trailer hitch to a handsfree liftgate equipped vehicle, the handsfree liftgate will become inoperative.
45578	Some 2015-2016 Edge and 2016 MKX customers may request to have the autolocks disabled. The autolocks are not a customer configurable feature. If a customer request to have the autolocks disabled, use IDS version 98.04 or higher to disable the autolocks. Enter Module Programming - Programmable Parameters - Power Door Locks - Auto Lock 1-5 - Enable/Disable. To disable the autolocks, Auto Lock 1 through Auto Lock 5 all need to be disabled prior to pressing the tick mark. Disabling the autolocks at the request of the customer cannot be claimed as a warrantable repair. Section 501-14 of the online Workshop Manual is being updated to provide direction on disabling the autolock feature.
45579	Some 2004-2016 Econoline/F-Super Duty with a Dana 70 or Dana 80 Trac-Loc ^Å 1 Limited-Slip Differential may exhibit a rear axle chatter during turns. If normal diagnosis leads to differential clutch chatter as the cause, engineering recommendation is to first add XL-3 Friction Modifier or equivalent, meeting Ford specification EST M2C118-A to the rear axle lubricant. For axle fill capacity of 2.84L (6 pints) or less, 1 bottle or 118 ml (4 fl. oz.) of XL-3 is required. For capacities exceeding 2.84L (6 pints), 2 bottles or 236 ml (8 fl. oz.) of XL-3 is required. The WSM is in the process of being updated to reflect correct quantity. Use applicable labor operations from Section 4 of the Service Labor Time Standards (SLTS) manual.
45583	Some 2011-2016 F-Super Duty 6.7L diesel equipped vehicles may exhibit a ticking noise at idle after an engine oil change. It is often referred to as Typewriter Noise because of its similarity to the sound of a mechanical typewriter. When engine temperatures reach 150 ÅF (65 ÅC) or higher, (from engine idle up to approximately 1700 RPM's), this noise can typically be heard at the front wheel well and is often isolated to the transmission bell housing or oil pan area. Typewriter Noise is not detrimental to engine function or durability and has no short or long term effects on the engine. Do not attempt repairs to eliminate this noise. This noise is characteristic of the 6.7L diesel engine and will typically cease or diminish significantly within the oil change maintenance interval.
45587	Some 2015-2016 F-150 vehicles may exhibit an exterior door handle trim cover that is not fully attached to the handle. The exterior door handle trim cover and the exterior handle are two separate pieces that are snapped together. If equipped, a keyless entry antenna may also be located between these two pieces. If the trim cover is not fully attached to the handle, attempt to reattach by squeezing the handle and trim cover together while listening for an audible click. If unable to reattach the trim cover, refer to the Workshop Manual, Section 501-14 for normal diagnosis.

ONLINE AUTOMOTIVE SERVICE INFORMATION SYSTEM FOR JANUARY 2016

45588	Some 2016 MKX vehicles built on or before 9/17/2015 may not have the ability to enable/disable the neutral tow function in the vehicle settings menu of the instrument cluster message center. To correct the concern use IDS version 98.04, select Module Programming - Programmable Parameters - Personality - Neutral Tow - Enable. Once the neutral tow function is enabled using the IDS, the selection to enable/disable neutral tow should display in the vehicle settings menu of the instrument cluster message center. For warranty claiming, use causal part 10849 and applicable 12651D labor operations in the SLTS Manual Section 10.
45594	Some 2011-2016 Fiesta and 2012-2016 Focus vehicles may set a P0606 Diagnostic Trouble Code (DTC) when battery or charging system issue is present or in the event of a dead or parasitic battery drain condition. Please diagnose and repair any U codes that are present or stored before condemning the TCM or any transmission hardware. Stored codes may have been set during new vehicle shipment or if the vehicle had a dead battery and was jump started. DTC's should be cleared and the charging system and battery inspected according to Diagnostic (PC/ED) manual or Workshop Manual (WSM), Section 414-00 for normal diagnostics. DTC P0606 Diagnostic chart and repair action in the Workshop manual is being updated to redirect the diagnostic in the event of the accompanying U codes.
45595	Some 2016 Escape vehicles equipped with Sirius satellite radio may exhibit an intermittent concern where the audio cuts out and the radio display reads no signal. Engineering is currently investigating this concern. Since this may be caused by multiple factors it is recommended to follow normal workshop manual diagnostics at this time. However, do not replace any components if clear root cause cannot be determined. To assist with the investigation use the Report A Vehicle Concern link at the bottom of the Oasis report and submit a Global Concern Report (GCR). Continue to monitor OASIS which will be updated with status on this investigation.
45599	Some 2012-2016 F-650/750 vehicles equipped with SYNC may have a U2101 DTC in the APIM which cannot be cleared. The U2101 DTC is commonly set in the APIM and can be disregarded as it does not affect SYNC system operation. No repair action is recommended for U2101.
45600	Some 2012-2016 F-650/750 vehicles equipped with SYNC may have a U2101 DTC in the APIM which cannot be cleared. The U2101 DTC is commonly set in the APIM and can be disregarded as it does not affect SYNC system operation. No repair action is recommended for U2101.
45601	Some 2016 MKC, MKX and MKZ vehicles built on or before 11/28/2015 and equipped with a TCU may exhibit an intermittent battery draw that can be isolated to the TCU, an inoperative MyLincoln Mobile app, a MyLincoln Mobile app deep sleep message, an inaccurate MyLincoln Mobile app oil life message, an incorrect MyLincoln Mobile app fuel level, a MyLincoln Mobile app false low tire warning, DTC U2100 and/or U2101 stored in the TCU. To correct the condition, program the TCU to the latest calibration using IDS version 98.03 or higher. Make sure you are connected to the internet when entering module programming to obtain the latest calibration. For warranty claiming, use causal part 19A387 and applicable labor operations in the SLTS Manual, Section 10.
45602	2011-2016 Fiesta and 2012-2016 Focus Transmission control module (TCM) Service Part AE8Z-7Z369-F may have reprogramming issues if the Integrated Diagnostic Software (IDS) release 98.04 is not being utilized. Without updating to this later level the TCM reprogramming will not complete and create a vehicle no start condition. Make sure you are connected to the internet when entering module programming to obtain the latest updates. The TCM Service Kit now contains two (2) required TCM O-rings so they will not have to be purchased separate to make the proper repair.
45606	2016 Fiesta with EATC Temp control has to be in HI position for heat to work. Any other position may blow unheated air. Engineering is currently investigating this condition. Until a new service procedure and/or parts are available do not attempt repair. Please submit a GCR (Global Concern Report)for concern vehicle and monitor OASIS for updates.

ONLINE AUTOMOTIVE SERVICE INFORMATION SYSTEM FOR JANUARY 2016

45607	Service procedures that require Misfire Profile re-learn will need to utilize Customer Drive Cycle Profile Correction procedure referenced in PC/ED manual Section 1 Description and Operation. IDS routine is currently not functioning properly and if attempted may result in engine stall and DTC P0607 in the PCM. To relearn misfire profile: Apply parking brake, get engine to operating temperature, let idle, apply brake, put vehicle in drive, run misfire neutral profile routine. Error will display on IDS screen but misfire profiles will be erased. Exit IDS profile learn routine, perform drive cycle to re-learn new misfire profile. Use IDS datalogger to verify MP_LRN PID (in PCM) indicates Yes(indicates NO if profiles are erased). Commanding ACC_CMD PID on may result in engine stall with DTC P0607 stored in PCM. Monitor OASIS for future updates.
45608	Some 2014 Focus vehicles built on or before 10/13/2013 may exhibit the Instrument Panel Cluster (IPC) displays PRNDL instead of PRNDS. The IPC should read PRNDS to match the shifter labels on the shifter bezel. Re-program the IPC using IDS release 98.01 or later. Make sure you are connected to the internet when entering module programming to obtain the latest updates. Calibration files may also be obtained at www.motorcraftservice.com . Use applicable 12651D labor operations in section 10 of the SLTS manual and causal part 10849 for reprogram only.
45609	Some 2016 Transit Connect vehicles equipped with SYNC and 4.2-inch (107 mm) non-touchscreen FCDIM (Front Control/Display Interface Module) may exhibit a concern in which the Radio A.M. function changes to F.M. when selected and/or the Satellite Radio display shows "not equipped". Engineering is currently investigating this concern. To assist with the investigation use the Report A Vehicle Concern link at the bottom of the Oasis report and submit a Global Concern Report (GCR). Replacing the ACM (Audio Control Module) and/or FCDIM will not fix this concern. Continue to monitor OASIS for updates.
45612	Some 2016 Explorer vehicles with Genuine Ford Accessory installed remote start systems may exhibit a concern where the Instrument Panel Cluster (IPC) Remote Start Climate Control menu items are grayed out and are not selectable. Reprogram the Heating Venting and Air Conditioning (HVAC) module to the latest calibration using IDS release 98.05 or higher. Make sure you are connected to the internet when entering module programming to obtain the latest updates. Calibration files may also be obtained at www.motorcraftservice.com . Use applicable 12651D labor operations in section 10 of the SLTS manual. Use causal part 18C612 for dual zone climate control or causal part 19980 for single zone manual climate control reprogramming only.
45616	Some 2016 F-Super Duty vehicles, built on or before 11/10/2015 may exhibit multiple symptoms that could be related to a water leak from the windshield A-pillar area on the passenger side. This condition is evidenced by signs of water, moisture, or corrosion at the connectors, pins, fuses or relays in the BCM (Base 15604). Refer to Workshop Manual Section (WSM) 419-10 for BCM access. If a water leak is identified, follow updated WSM Section 501-11 for diagnosis and repairs and reseal the windshield. Use available Service Labor time Standards (SLTS). Follow normal warranty policy manual for warranty coverage.
45618	Some 2013-2016 Edge/MKX/Escape/MKC/Fusion/MKZ/Flex/MKT all wheel drive (AWD) vehicles may now be serviced with a new rear drive unit (RDU) service kit. For vehicles with symptoms including shudder, chatter, grinding, banging, popping, clicking or binding from the RDU at any time, or inadequate torque at the rear wheels, check the parts catalog using vehicle identification number (VIN) for base part 4A232. If clutch assembly part number is not listed in the catalog this message does not apply. For VINs which a kit is listed, see removal and installation for Active Torque Coupling Clutch. Refer to WSM, Section 205-02. Use applicable 7453D labor operation(s) in the Service Labor Time Standards (SLTS) manual, Section 7.
45620	Service replacement of a 2015-2016 Transit antilock brake system (ABS) module or hydraulic control unit (HCU) may result in ABS warning lamp illumination and diagnostic trouble code (DTC) U2101 due to a configuration file within the service module that does not match the vehicle. To resolve this issue, verify the IDS is at release 98.04 or higher and start a new IDS session. Download as-built data (select Module Programming; As-Built; ABS). IDS will ask if you were directed here from another procedure such as programmable module installation or module reprogramming to obtain part numbers, answer YES. After the IDS has downloaded the necessary files, select Programmable Module Installation and follow the prompts to complete the programming and configuration.

ONLINE AUTOMOTIVE SERVICE INFORMATION SYSTEM FOR JANUARY 2016

45621	Some 2013-2016 Escape and 2015 Edge vehicles equipped with My Ford Touch may exhibit a CD stuck in the player when attempting to eject. Prior to following normal diagnostics, check for misalignment of CD player to instrument panel center middle trim panel. Refer to WSM, Section 501-12 for removal and installation. Attempt to eject the CD while panel is removed. If the CD ejects, realign the Audio Front Control Module(ACM) for proper alignment of panel to CD slot and do not replace the ACM. If the CD does not eject with panel removed, reset the ACM by disconnecting ACM connectors, wait 10 seconds and reconnect and attempt CD removal. If CD does not eject after reset, follow normal WSM diagnostics. Only use radio as causal part if replaced during normal WSM diagnostics. Use applicable labor operations from Section 11 of the SLTS manual.
45622	Some 2015-2016 Transit Low Roof vehicles equipped with 3.5L or 3.7l engines and built on 3/31/15 and through 10/15/15 may exhibit a rough run or misfire condition along with Malfunction Indicator Lamp (MIL) illumination and Diagnostic Trouble Codes (DTC) P0304, P0305, and/or P0306. If diagnostics lead to ignition coil or spark plug replacement, water ingress is a likely cause. In addition to completing the necessary repairs, install a revised passenger side wiper arm grommet seal CK4Z-17C582-A.
45623	Some 2011 thru 2016 Ford or Lincoln vehicles equipped with MyFord/MyLincoln touch and version 3.8 software or SYNC 3 may exhibit Siri Eyes Free not working over Bluetooth properly with iPhones using iOS 9.2 and 9.2.1 software. Ford is currently working with Apple on a resolution. As a workaround, plugging the iPhone into a USB port allows Siri Eyes Free to operate properly. Recommend that the customer have their iPhone plugged into a USB port to operate Siri. Plugging the iPhone in a USB port may cause Autoplay to start playing USB media. Autoplay can be disabled or enabled using the process in the Owner's Manual or SYNC Supplemental Guide. Monitor OASIS for future updates.
45624	Some 2016 Escape/MKC/Fiesta/F150/Expedition/Navigator/Mustang/Transit/Focus/ C-Max/MKX/Taurus/MKS/Flex/MKT and Edge vehicles equipped with SYNC 3 might exhibit a blank screen or other various SYNC symptoms only when the vehicle is in Transport mode. Engineering is aware of this possibility and it is considered normal due to the power saving features enabled while in transportation mode. It is beneficial to extended battery life to keep the vehicle in Transport Mode until the vehicle is prepped for sale. If the vehicle should exhibit a blank screen or other SYNC symptoms after it has been taken out of Transport mode, refer to Workshop Manual, Section 415-00 for normal diagnosis.
45626	Some 2016 Explorer vehicles built on 9/1/2015 and through 10/31/2015 may exhibit a pop or creak type noise from the front right sub frame bolt. If normal diagnosis identifies the noise as originating from the right front sub frame bolt, please do not replace any components or attempt repairs at this time. Engineering is currently investigating this issue. If the noise is identified to be present from another component or location, continue with normal diagnostics and repairs. Continue to monitor oasis for updates.