

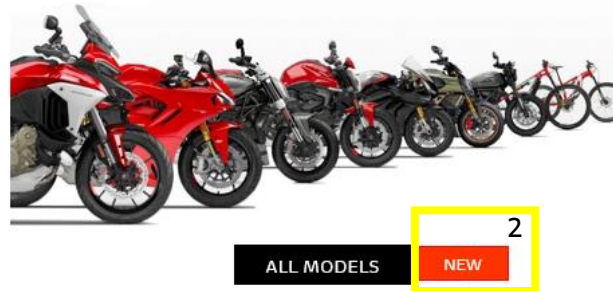

# Instructions for navigating the document

## Index of models



**NEW TOPICS** 3

MULTISTRADA: > Right-hand switch button backlighting  
> Possible appearance of stains and white dots on the instrument panel  
> Possible malfunction of the heated passenger seat  
> Upcoming Infotainment and HMI improvements

SUPERSPORT: > Engine warning light on: ECU Error P0314

SCRAMBLER: > Irregular idling rpm after engine start  
> Possible appearance of errors U0323, P0500, P2158

ALL MODELS: > Error P0314 Validation: High misfire with risk of damaging the catalytic converter  
> Control unit reprogramming

1. By clicking on a vehicle icon you can view the Tips & Tricks for that model family.
2. By clicking on the "New" icon you can view the new Tips & Tricks.
3. The "New Topics" section summarizes the new Tips & Tricks introduced with the new revision.
4. By clicking on the icon you can go back to the model Index.



## Index of models



DIAVEL

NEW



HYPERMOTARD



MONSTER



MULTISTRADA

NEW



ALL MODELS

NEW



SUPERBIKE



SCRAMBLER



STREETFIGHTER



SUPERSPORT

### NEW TOPICS

- MULTISTRADA:
- Possible presence of error U1900-*Optional Configuration not carried out*
  - Possible interference between tank bag and front brake fluid reservoir/clutch fluid reservoir
  - Possible color change of the Akrapovič silencer carbon endcap
- DIAVEL
- Indication for replacement of brake hoses under warranty
- ALL MODELS
- Possible damage to water pump gear oil seal





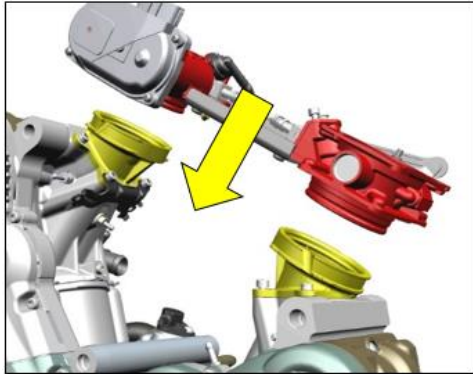
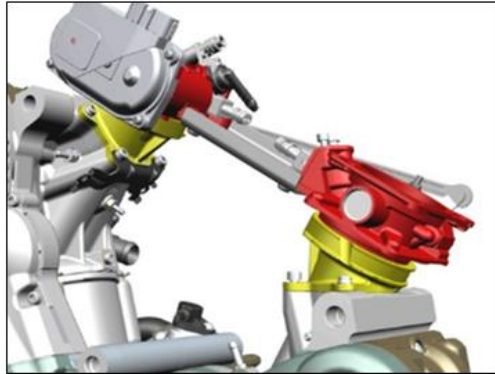
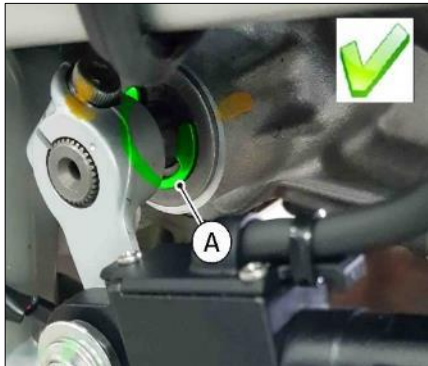

## ← Tips & Tricks – All models

no.	Symptom	Subject	Photo	Notes and Indications - Corrective action
1	<p><u>ONLY</u> <u>Monster 821</u> <u>Monster 1200</u> <u>SuperSport</u></p> <p>Possible engine popping sound during deceleration and/or irregular idling</p>	Airbox		<p>We have received some complaints about a possible engine popping sound during deceleration. The performed analyses have shown that this symptom could be caused by an incorrect installation of the throttle bodies in the relevant intake manifolds (possible deformation of the rubber profile).</p> <p>Therefore, if you find any similar symptoms, we kindly ask you to check the correct installation of the Airbox on the motorcycle and in particular that:</p> <ul style="list-style-type: none"><li>- throttle bodies are correctly inserted inside rubber intake manifolds, along the whole perimeter;</li><li>- the rubber profile of the intake manifolds is not deformed.</li><li>- the 2 fastening ties are correctly positioned in the seat on the intake manifolds</li></ul> <p><b>Please be reminded that, in order to make throttle body insertion easier on rubber intake manifolds, the use of silicone lubricant or similar product is absolutely necessary.</b></p> <div data-bbox="1137 675 2125 1050"></div>
2	<p><u>ONLY</u> <u>Panigale V4</u> <u>(all versions)</u> <u>Streetfighter V4</u> <u>(all versions)</u></p> <p>Introduction of gear selector shaft certification</p>	Gear selector		<p>We have received some isolated reports of a possible loss/absence of the <b>snap ring (A)</b> of the gear selector shaft. We would like to inform you that an additional certification on all Desmosedicci Stradale engines between snap ring, washer, and crankcase at the outlet of the gear selector shaft has been added along the production line. The first engine serial number with this new certification is ZDM1100WC #001513#.</p> <p>Upon the first workshop service, you are thus invited to check for the presence of the <b>snap ring (A)</b> on all engine serial numbers preceding the one specified above.</p> <div data-bbox="1771 1066 2197 1433"></div>



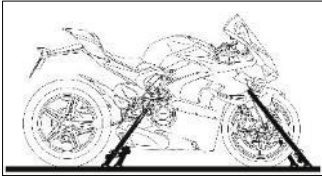



## ← Tips & Tricks – All models

no.	Symptom	Subject	Photo	Notes and Indications - Corrective action
3	Motorcycle fastening precautions during transport	Motorcycle transport		<p>We have received some reports of damaged handlebars; the cause was incorrect transport in a van or truck!</p> <p>For correctly fixing the motorcycle, in case of transport, the following precautions must be observed:</p> <ol style="list-style-type: none"> <li>1. Remove all loose objects and accessories;</li> <li>2. Aim the front wheel to the riding position and lock it properly to prevent it from moving;</li> <li>3. Engage the first gear;</li> <li>4. <u>Use anchoring straps/slings and apply them to solid components (e.g. frame) and NOT to handlebar(s) or to components that could break (e.g. handgrips, rear-view mirrors, etc.).</u></li> <li>5. The straps or ropes used must NOT rub against the painted components of the motorcycle;</li> <li>6. The suspensions, if possible, must be in a partially compressed position to allow less movement of the motorcycle with respect to the road surface.</li> </ol>
4	<p><u>ONLY</u> <b>Panigale V4S MY2020</b> <b>Streetfighter V4S</b> <b>MY2020</b></p> <p>Possible noise for rebound limit stop</p>	Öhlins fork		<p>We inform you that in particular conditions, when moving the motorcycle from standstill, you can hear a metallic "clack" sound when the fork is fully extended. This sound is simply due to the fork reaching the upper limit stop. The new fork setting has an increased spring preload, making it easier to reach this condition compared to previous Model Years.</p> <p>You can clearly hear the sound in question by leaving the motorcycle on the side stand and then extending the fork completely by pulling the motorcycle toward you from the handlebars.</p> <p>Since this situation does NOT occur during normal use of the motorcycle, it should not be considered a functional defect and should not lead to disassembly/replacement of any part.</p>
5	<p><u>ONLY</u> <b>models equipped with</b> <b>DQS (Ducati Quick Shift)</b></p> <p>Precautions for a correct use of the DQS (Ducati Quick Shift)</p>	DQS (Ducati Quick Shift)		<p>We have received reports of some complaints about rough shifting with DQS, particularly at low rpm. In other words, rough shifting with uncomfortable torque cuts.</p> <p>We have checked that very often <b>the cause is related to an incorrect chain tensioning</b>, especially after the first settling of the chain which takes place at around 200/300 Km (new motorcycle or chain). We therefore invite you to always check the correct tensioning of the final drive chain before making further analysis.</p> 





## ← Tips & Tricks – All models

no.	Symptom	Subject	Photo	Notes and Indications - Corrective action
6	<p><u>ONLY</u> <u>models equipped with</u> <u>hydraulically controlled</u> <u>clutch lever</u></p> <p>Possible reduction of the clutch fluid level inside its reservoir</p>	Hydraulic clutch control		<p>We received a few claims concerning a reduction of the clutch fluid level inside its reservoir. We would like to inform you that it is not sufficient to carry out the bleeding procedure or top up the clutch fluid inside the reservoir. We suggest, at a preliminary stage, to check:</p> <ul style="list-style-type: none"><li>• the play between the clutch master cylinder and the lever</li><li>• if the clutch pushrod is worn or damaged in the area of contact with the clutch slave cylinder (ball)</li><li>• the condition of the clutch slave cylinder protective diaphragm, which must not be torn.</li></ul> <p>According to our analyses, this phenomenon is due to a DOT4 leakage from the primary seal of the clutch slave cylinder (missing fluid in the reservoir builds up in-between the clutch slave cylinder diaphragms); in some cases, this phenomenon is also accompanied by wear of the clutch pushrod. We therefore ask you to replace the slave cylinder with a new <b>part no. 19540091D</b> featuring a new gasket in order to prevent the phenomenon described above.</p> <p>If the clutch pushrod is damaged as shown in the figure, replace it as well.</p> <div data-bbox="1227 719 2024 1018"></div>

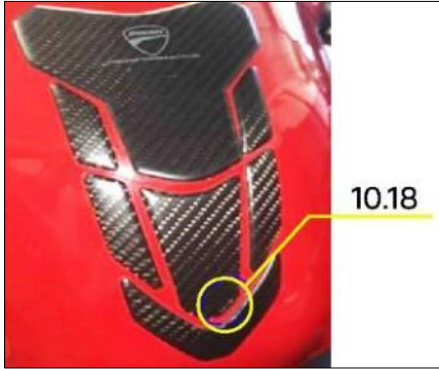

## ← Tips & Tricks – All models

no.	Symptom	Subject	Photo	Notes and Indications - Corrective action
7	<p><u>ONLY</u> <b>Panigale V4</b> <b>Streetfighter V4</b> <b>(all model versions)</b></p> <p>Possible detachment of the carbon adhesive protection <b>part no. 97480161A</b> from the fuel tank</p>	<p>Tank carbon adhesive protection <b>part no. 97480161A</b></p>		<p>We have received some reports about the detachment of the carbon adhesive protection from the fuel tank. We inform you that the supplier of the component has introduced improvements to avoid the detachment of the protection, since year of manufacture 2019. The lot and the year of manufacture <b>XX-19 (week-year of manufacture)</b> can be identified on the component, like in the example shown in the figure.</p>  <p>In case you still have in stock some carbon tank protectors produced in 2018 you can still sell them to Customers and install them. Should any anomaly occur on the latter, you can manage the replacement of the protection through an accessory warranty. The spare parts in stock have been reclaimed.</p> <p>In any case, it is essential to follow the accessory instructions ISTR-892 ed.01 published in DCS for the application of the tank protection. The cleaning of the tank surface and the use of the template supplied with the protection are essential for a successful application.</p>
8	<p>Possible formation of a well-marked "band" in correspondence with the central area of the Pirelli Diablo Rosso Corsa II rear tire</p>	<p>Pirelli Diablo Rosso Corsa II rear tire</p>		<p>We have received some isolated reports of the appearance of a "band" in correspondence with the central area of the Pirelli Diablo Rosso Corsa II rear tire.</p> <p>We would like to inform you that, since these are extremely sporty tires with 5 different compound zones at the rear, it can happen that, depending on the type of use of the motorcycle, they wear out in a different way causing the above mentioned phenomenon to occur; sometimes this occurs on the shoulder area, sometimes in the central area but, in general, it is a purely aesthetic phenomenon that does not affect the performance of the tire itself.</p> 



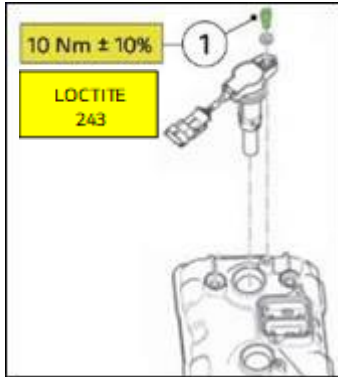

## ◀ Tips & Tricks – All models

no.	Symptom	Subject	Photo	Notes and Indications - Corrective action
9	<p><u>ONLY</u> <u>Panigale V4</u> <u>Streetfighter V4</u> <u>(all model versions)</u></p> <p>Possible engine oil leakage from the water pump drain hole</p>	Water pump		<p>We have received some isolated reports of possible traces of engine oil leaking out of the drain hole of the water pump; the analysis has shown that this phenomenon is due to a possible incorrect installation of the oil seal by the supplier.</p> <p>We inform you that a new re-designed water pump <b>Part no. 24920510H</b> that avoids the phenomenon described above is now available as a spare part . Should you find traces of engine oil in the drain hole of the water pump on engines with serial number prior to the one indicated above, replace the component.</p>
10	<p><u>ONLY</u> <u>Panigale V4</u> <u>Streetfighter V4</u> <u>(all model versions)</u></p> <p>Possible engine power delivery discontinuity</p>	Engine power delivery	-	<p>We have received some isolated reports about a possible engine power delivery discontinuity.</p> <p>Before making further analyses, we would like to ask you to check coil fastening and, in particular, to <u>apply LOCTITE 243</u> along the threading of fastening screws and tighten them to <b>10 Nm ± 10%</b>.</p> 
11	<p><u>ONLY</u> <u>Panigale V2 MY20-21</u> <u>Hypermotard 950 MY19-21</u> <u>Monster 821 MY18-21</u> <u>Monster 1200 MY19-21</u> <u>(all model versions)</u></p> <p>Instrument panel lighting shifts from night to day mode even without any ambient light</p>	Instrument panel	-	<p>We have received some isolated reports about the instrument panel shifting from night to day mode even without any ambient light.</p> <p>If this phenomenon occurs, the instrument panel must be replaced.</p> <p>We would like to inform you that this issue has been analyzed and solved, and that the spare parts in stock have been restored.</p>



## ← Tips & Tricks – All models

no.	Symptom	Subject	Photo	Notes and Indications - Corrective action																			
12	<p><u>ONLY</u>  <b>Streetfighter V4</b>  <b>Panigale V4</b>  <b>Superleggera V4</b></p> <p>Instrument panel failed switching on upon Key-ON</p>	Instrument panel	-	<p>We received some isolated reports about instrument panel failed switching on; this phenomenon is due to a damage of the instrument panel power supply circuit caused by power disturbance. Should this phenomenon persist, the component must be replaced. The spare instrument panels have been restored thanks to the introduction of a new circuit avoiding the described symptom</p> <table border="1"> <thead> <tr> <th>Model</th> <th>Model Year</th> <th>Part no.</th> </tr> </thead> <tbody> <tr> <td>Streetfighter V4</td> <td>20</td> <td>40611781C</td> </tr> <tr> <td>Panigale V4 25° Anniversario 916</td> <td>20</td> <td rowspan="2">40611351I</td> </tr> <tr> <td>Panigale V4 / Panigale V4 S</td> <td rowspan="2">18-19</td> </tr> <tr> <td>Panigale V4 S Corse</td> <td rowspan="3">20</td> <td rowspan="3">40611351H</td> </tr> <tr> <td>Panigale V4 / Panigale V4 S</td> </tr> <tr> <td>Panigale V4 S Corse</td> </tr> <tr> <td>Superleggera V4</td> <td></td> <td></td> </tr> </tbody> </table>	Model	Model Year	Part no.	Streetfighter V4	20	40611781C	Panigale V4 25° Anniversario 916	20	40611351I	Panigale V4 / Panigale V4 S	18-19	Panigale V4 S Corse	20	40611351H	Panigale V4 / Panigale V4 S	Panigale V4 S Corse	Superleggera V4		
Model	Model Year	Part no.																					
Streetfighter V4	20	40611781C																					
Panigale V4 25° Anniversario 916	20	40611351I																					
Panigale V4 / Panigale V4 S	18-19																						
Panigale V4 S Corse		20	40611351H																				
Panigale V4 / Panigale V4 S																							
Panigale V4 S Corse																							
Superleggera V4																							
13	<p><u>ONLY</u>  <b>Diavel Model Year 21</b>  <b>XDiavel Model Year 21</b>  <b>Multistrada 1260</b>  <b>Model Year 18-20</b>  <b>Multistrada 1260 Enduro</b>  <b>Model Year 19-21</b>  <b>Multistrada 950S</b>  <b>Model Year 19-21</b></p> <p>Possible loss of the active key rear cover</p>	Active key Part no. 59810361F		<p>We have received some isolated reports about the possible loss of the rear cover of the active key Part no. 59810361F. Analyses have shown that this phenomenon occurs after repeated opening/closing of the cover itself, resulting in the deterioration of the shell.</p> <p>We would like to inform you that the new rear cover <b>Part no. 4601L831A</b>, avoiding the phenomenon described above, is now available.</p> 																			





## ← Tips & Tricks – All models

no.	Symptom	Subject	Photo	Notes and Indications - Corrective action
14	<p><u>ONLY</u> <u>Panigale V4 S</u> <u>Streetfighter V4 S</u></p> <p>Possible storage of errors:</p> <ul style="list-style-type: none"><li>- C100C shock absorber rebound - Open circuit</li><li>- C1009 shock absorber compression - Open circuit</li></ul>	Öhlins monoshock	-	<p>We have received some reports of the following errors being stored:</p> <ul style="list-style-type: none"><li>- <b>C100C: shock absorber rebound - Open circuit</b></li><li>- <b>C1009: shock absorber compression - Open circuit</b></li></ul> <p>If any of the above errors are detected, please carry out the following test to confirm the need for replacement of the Öhlins rear monoshock:</p> <ol style="list-style-type: none"><li>1) Swap the connections of the compression and rebound stepper motors;</li><li>2) Delete any errors stored;</li><li>3) Perform a Global Scan and determine if a new error code for the rear shock damping is validated</li><li>4) If it is so, change the rear monoshock.</li></ol>
15	<p><u>ONLY</u> <u>Panigale V4 MY21</u> <u>Streetfighter V4 MY21</u></p> <p>Precautions for installing Akrapovič titanium racing full exhaust system</p>	Akrapovič titanium racing full exhaust		<p>-</p> <p>Please note that when installing the Akrapovič titanium racing full exhaust system, <u>ONLY for the specified models</u>, it is NOT necessary to remove the canister filter and the purge valve. If they need to be removed, error <b>P0444 "purge valve open"</b> will be stored in the engine ECU and the <b>MIL</b> warning light will be displayed on the instrument panel.</p> <p>The Ducati Performance assembly instructions have been updated.</p>



## ← Tips & Tricks – All models

no.	Symptom	Subject	Photo	Notes and Indications - Corrective action
16	Error P0314 Validation: High misfire with risk of damaging the catalytic converter	Airbox	-	<p>We have received some reports about the engine warning light coming on due to ECU error P0314. The error refers to high Misfire with risk of damage to the catalytic converter. Should this be the case, we ask you to open a <b>Youtech</b> service request, enclosing the following information:</p> <ul style="list-style-type: none"><li>• Did the vehicle have the MIL warning light on when entering the workshop?</li><li>• Did the customer experience a torque limitation after the warning light came on?</li><li>• Recording of the following parameters:<ul style="list-style-type: none"><li>- Engine rpm</li><li>- Engine Temperature</li><li>- Air Temperature</li><li>- Vertical Cylinder MAP value (mBar)</li><li>- Horizontal Cylinder MAP value (mBar)</li><li>- Vertical Cylinder Injection Timing value</li><li>- Horizontal Cylinder Injection Timing value</li><li>- Vertical Cylinder Injection Time Correction by Lambda Control</li><li>- Horizontal Cylinder Injection Time Correction by Lambda Control</li><li>- A/F Self Learning parameters on Vertical Cylinder (Offset)</li><li>- A/F Self Learning parameters on Horizontal Cylinder (Offset)</li></ul></li><li>• Activate the secondary air circuit, taking note of the values at the end of the activation.</li><li>• Check final drive chain proper tensioning.</li></ul> <p>Please enclose the complete folder, with the date and time of the recording in its name, in compressed .zip or .rar format.</p> <p>The recording file can be found at the following location:</p> <ul style="list-style-type: none"><li>- DDS 2.0 → C:\ProgramData\Ducati\DDS20\vehicle\data\autodia\sessions</li><li>- DDS 3.0 → C:\ProgramData\Ducati\DDS30\vehicle\data\autodia\sessions</li></ul>





## ← Tips & Tricks – All models

no.	Symptom	Subject	Photo	Notes and Indications - Corrective action
17	Control unit reprogramming	Service Update	-	<p>We are detecting several cases of unintended use of the SERVICE UPDATE function, allowing to force software installation in the control units installed on vehicles. An example is the reprogramming of control units operating with the same software version already installed. This practice is useless and can sometimes lead to further problems.</p> <p>We therefore kindly ask you not to take advantage of this function, but to use it ONLY in case of interrupted reprogramming.</p> <p>Should you have any doubts, please fill out a <b>Youtech</b> service request to receive the necessary support.</p>
18	<p><u>ONLY</u> <u>Diavel 1260 MY21-22</u> <u>XDiavel MY21-22</u> <u>Multistrada MY21-22</u></p> <p><u>models featuring the Hands Free system</u></p> <p>Hands free system software reprogramming failure. Control unit lockout / bike off.</p>	Hands Free		<p>We have received a few reports concerning the interruption of the software programming of the Hands Free system.</p> <p>If the problem occurs, at the next key-OFF it will no longer be possible to set the bike key to ON, as in this status the control unit does not activate the main relay of the ignition switch positive wires.</p> <p>Hands Free unit replacement is <u>NOT required</u>. To restore correct operation, simply follow this procedure:</p> <ol style="list-style-type: none"><li>1. Disconnect the negative pole of the battery and leave it disconnected for 5 minutes.</li><li>2. Reconnect the negative pole of the battery.</li><li>3. <u>Press the key-on button on the hands free control unit only once.</u> → <b>Pay attention to this step as the instrument panel will remain OFF, hence with no visual confirmation that the button has been pressed only once.</b></li><li>4. From the DDS model list, select the family and SERVICE UPDATE model of the bike being diagnosed.</li><li>5. Select "Hands Free Reprogramming", then the software to be loaded according to the installed Hands Free country version → 9999_434_S022 for all countries (except Japan where file 9999_315_S022 must be selected.)</li><li>6. Wait for the diagnosis instrument to communicate with the Hands Free control unit and continue programming.</li><li>7. Follow the displayed instructions until the reprogramming procedure is complete.</li></ol> <p>If the procedure does not allow unlocking the control unit, repeat the procedure from step 1), paying particular attention to step 3).</p>



## ← Tips & Tricks – All models

no.	Symptom	Subject	Photo	Notes and Indications - Corrective action
19	<p><u>ONLY</u> <u>Panigale V4</u> <u>Streetfighter V4</u></p> <p>Possible improper tightening of front brake hose retaining clip fastening nut</p>	Front brake hose retaining clip fastening nut		<p>We have received some reports about the improper tightening of front brake hose retaining clip fastening nut due to external machining operations requiring the involved clip to be removed.</p> <p>Check nut correct tightening during the first tightening at your workshop to avoid incorrect positioning of front brake hoses.</p> <p>Should you detect nut loosening, follow the instructions on the workshop manual for front brake hose correct positioning, and tighten nut to a torque of <b><u>4 Nm ± 10%</u></b>.</p>
20	Update of engine oil filter cartridge tightening torque	Engine oil filter cartridge		<p>Please, be informed that following changes concerning the engine oil filter cartridge, the tightening torque has been increased from 11 Nm to <b><u>13 Nm ± 1 Nm</u></b>.</p> <p>Please be reminded to lubricate the oil filter cartridge seal with engine oil and to use a commercial tool for tightening, as shown in the figure.</p>





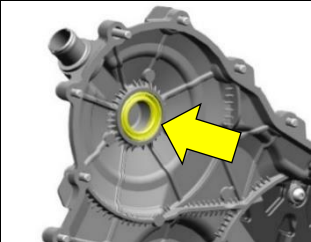
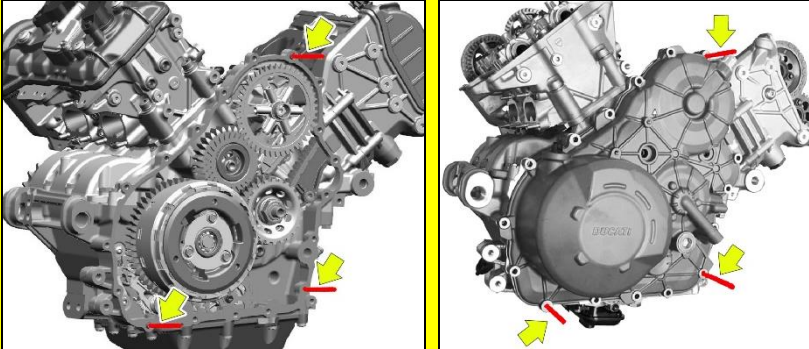

## ← Tips & Tricks – All models

no.	Symptom	Subject	Photo	Notes and Indications - Corrective action
21	<p><b>NEW</b></p> <p><u>ONLY</u> <b>Desmosedici Stradale V4</b> <b>ENGINES</b></p> <p>Possible damage to water pump gear oil seal</p>	Water Pump Gear Oil Seal		<p>We have received some reports of a pronounced blow-by effect that may cause small amounts of oil to leak from the clutch cover. This effect could be caused by excessive wear of the water pump gear oil seal on the clutch cover.</p> <p>If this problem is found, we suggest that you check the condition of the oil seal inside the clutch cover and replace it if necessary. When replacing it, remember to lubricate the oil seal with KLÜBERPLUS S 06/100 lubricant (or equivalent) and reposition it correctly using tool part no. <b>887138858</b>.</p> <p><u>Warning:</u> During refitting, for correct positioning of the clutch cover, it is necessary to use 3 centering pins <b>part no. 887132933</b>, positioned as shown in the figure, to avoid possible damage to the water pump gear oil seal.</p> 

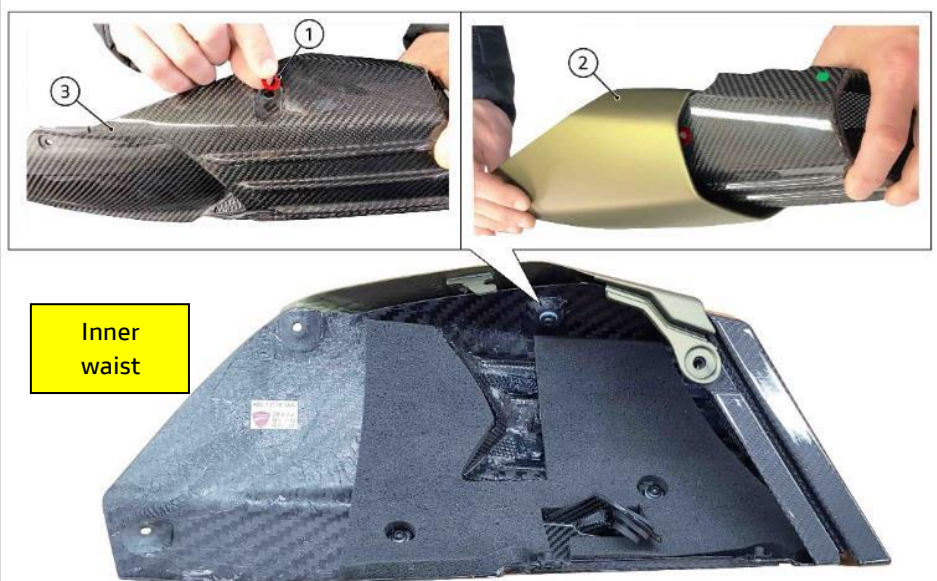

no.	Symptom	Subject	Photo	Notes and Indications - Corrective action
1	<p><u>ONLY</u> <u>Diavel Lamborghini</u></p> <p>Possible indentation of RH and/or LH outer cover of the air conveyor</p>	RH and LH air conveyor covers		<p>We have received some isolated reports about a possible indentation of the RH and/or LH outer cover of the air conveyor.</p> <p>To avoid this phenomenon, it is necessary to position <b>washer (1)</b> 4x14x1 Part no. 85240171A between <b>outer cover (2)</b> and carbon air <b>conveyor (3)</b> in the upper fixing point, as shown in the figure.</p>  <p><b>Inner waist</b></p>



# ← Tips & Tricks – Diavel

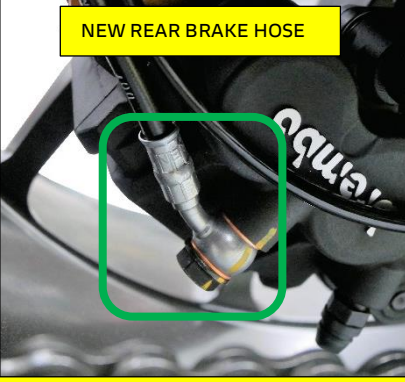
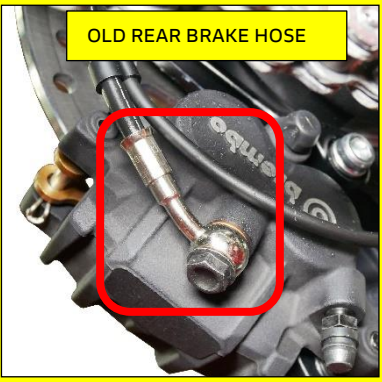

no.	Symptom	Subject	Photo	Notes and Indications - Corrective action												
2 <span style="color: red; font-weight: bold; font-size: small;">NEW</span>	<p style="text-align: center;"><b>ONLY</b> <b>Diavel 1260</b></p> <p>Indication for replacement of brake hoses under warranty</p>	Rear Brake Hose	-	<p>We remind you that from the dates below the DIAVEL 1260 model is equipped with the new brake hoses.</p> <p>In the event that you have to manage a Customer complaint related to a rear brake system, always check the rear brake hoses installed on the vehicle.</p> <p>If the bike is already equipped with the modified hoses (FrenTubo), the warranty claim will be NOT accepted or will be charged back.</p> <table border="1" data-bbox="1176 507 2078 654"> <thead> <tr> <th>Production Plant</th> <th>Bike Version</th> <th>Indicative production date</th> </tr> </thead> <tbody> <tr> <td>DMH / DAFRA</td> <td>ALL versions, CHN excluded</td> <td>January 01, 2020</td> </tr> <tr> <td>DMT</td> <td>ALL versions, CHN excluded</td> <td>March 01, 2020</td> </tr> <tr> <td>DMH / DMT</td> <td>CHN version only</td> <td>January 01, 2021</td> </tr> </tbody> </table> <div style="display: flex; justify-content: space-around; margin-top: 10px;"> <div data-bbox="1227 683 1630 1066">  <p style="text-align: center; font-weight: bold; font-size: small;">NEW REAR BRAKE HOSE</p> </div> <div data-bbox="1653 683 2033 1066">  <p style="text-align: center; font-weight: bold; font-size: small;">OLD REAR BRAKE HOSE</p> </div> </div>	Production Plant	Bike Version	Indicative production date	DMH / DAFRA	ALL versions, CHN excluded	January 01, 2020	DMT	ALL versions, CHN excluded	March 01, 2020	DMH / DMT	CHN version only	January 01, 2021
Production Plant	Bike Version	Indicative production date														
DMH / DAFRA	ALL versions, CHN excluded	January 01, 2020														
DMT	ALL versions, CHN excluded	March 01, 2020														
DMH / DMT	CHN version only	January 01, 2021														



## ◀ Tips & Tricks – Hypermotard Family

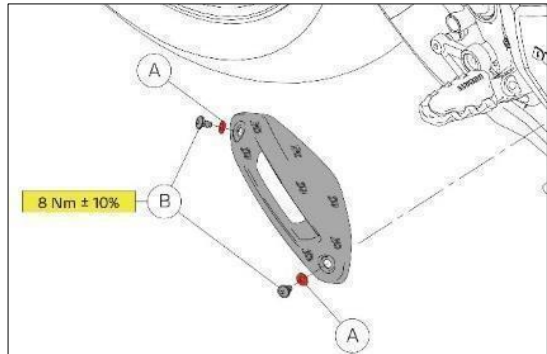

no.	Symptom	Subject	Photo	Notes and Indications - Corrective action
1	<p style="text-align: center;"><u>ONLY</u> <u>Hypermotard 950</u></p> <p>Possible engine hard starting and/or erratic idling</p>	Engine	-	<p>We have been informed about possible engine starting issues and/or erratic idling.</p> <p>Connect the DDS2.0 diagnosis instrument to the motorcycle and:</p> <ol style="list-style-type: none"> <li>1) if the following errors are present: <ul style="list-style-type: none"> <li>- <b>Error P2303</b> "horizontal cylinder coil control, open circuit or short-circuit to ground"</li> <li>- <b>Error P2300</b> "vertical cylinder coil control, open circuit or short-circuit to ground"</li> </ul> carry out a coil activation test and proceed with the replacement <u>only</u> in case of a malfunction (always fill in a <b>Youtech</b> service request) </li> <li>2) in case of no errors stored in memory, fill in a <b>Youtech</b> service request and attach the recording of the following parameters (at idling rpm, from cold to fan switch-on): <ul style="list-style-type: none"> <li>- Injection time correction of horizontal and vertical cylinders (from lambda sensor)</li> <li>- Horizontal and vertical cylinder ignition advance</li> <li>- Vertical and horizontal cylinder injector injection time</li> <li>- Engine speed and engine temperature</li> <li>- A/F offset adaptive parameter for horizontal and vertical cylinders</li> <li>- Air mass flow in the horizontal and vertical cylinders</li> <li>- MAP pressure sensor for horizontal and vertical cylinders</li> <li>- TPS Sensor</li> <li>- Absolute percentage of throttle opening</li> </ul> </li> </ol> <p>We also suggest you inspect the intake nipple pipe union connections to MAP sensor and perform a coil activation test with a possible attempt to replace the coil on the cylinder with negative air/fuel adaptive parameter values (close to or higher than 1mg/tdc).</p>
2	Update of the assembly instructions for the carbon horizontal manifold heat guard kit part no. 96980251A	carbon horizontal manifold heat guard kit part no. 96980251A		<p>We inform you that the assembly instructions for the carbon horizontal manifold heat guard kit by Ducati Performance part no. 96980251A have been updated. In particular, in order to install the part, <u>you must reuse the 2 washers (A) present on the original heat guard.</u></p> <p>Please always comply with the tightening torque of the 2 screws M6x12 (B) of <b>8 Nm ± 10%.</b></p> 





## ◀ Tips & Tricks – Hypermotard Family



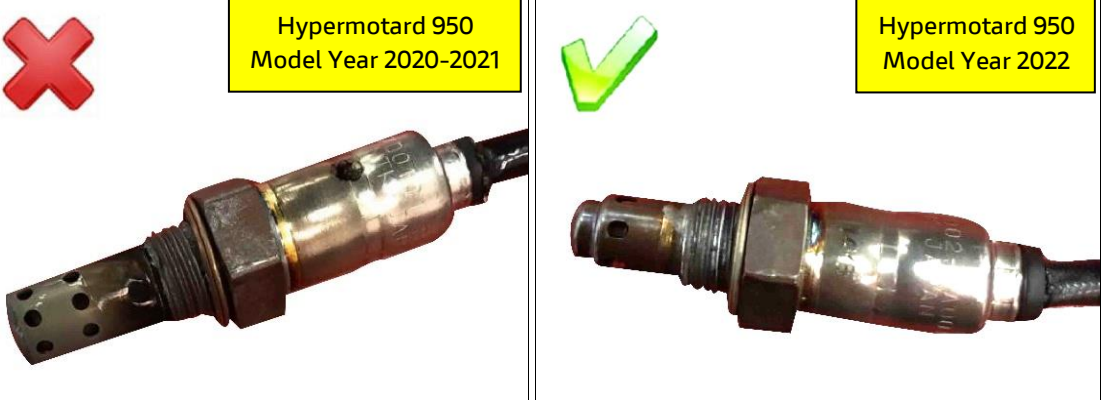



no.	Symptom	Subject	Photo	Notes and Indications - Corrective action
3	<p><u>ONLY</u> <b>Hypermotard 950 MY22</b></p> <p>Possible validation of errors P2A03 Horizontal cylinder lambda sensor (oxygen sensor) [Value out of range] and/or P2A00 Vertical cylinder lambda sensor (oxygen sensor) [Value out of range]</p>	Lambda sensors	-	<p>We have received some isolated reports of the possible validation of the following errors:</p> <ul style="list-style-type: none"><li>• P2A03 Horizontal cylinder lambda sensor (oxygen sensor) [Value out of range]</li><li>• P2A00 Vertical cylinder lambda sensor (oxygen sensor) [Value out of range]</li></ul> <p>after riding only 1000km/600mi.</p> <p>Our analysis has shown that this phenomenon is linked to the possible installation of lambda sensors relating to the previous Model Year (Model Year 2020-2021 EURO4 version) despite having the same connector on the wiring side.</p> <p>We would like to inform you that the production line has made the process more robust in order to avoid this issue.</p> <p>Should you find the above mentioned errors, we ask you to ensure that the dedicated lambda sensors part no. 55215021A for the Hypermotard 950 Model Year 2022 are actually installed</p> <div data-bbox="1048 647 2168 1056"><p>The image shows two lambda sensors side-by-side. The one on the left is marked with a red 'X' and labeled 'Hypermotard 950 Model Year 2020-2021'. It has a horizontal cylinder design. The one on the right is marked with a green checkmark and labeled 'Hypermotard 950 Model Year 2022'. It has a vertical cylinder design.</p></div>



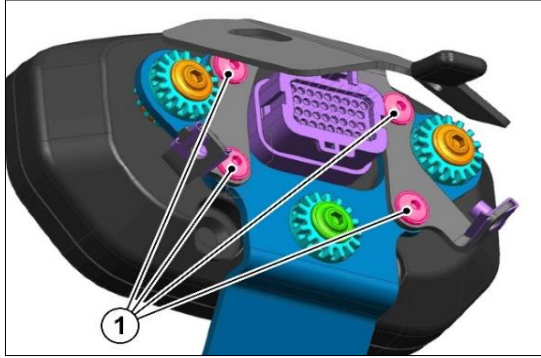

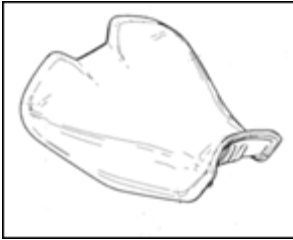

## ← Tips & Tricks – Monster Family



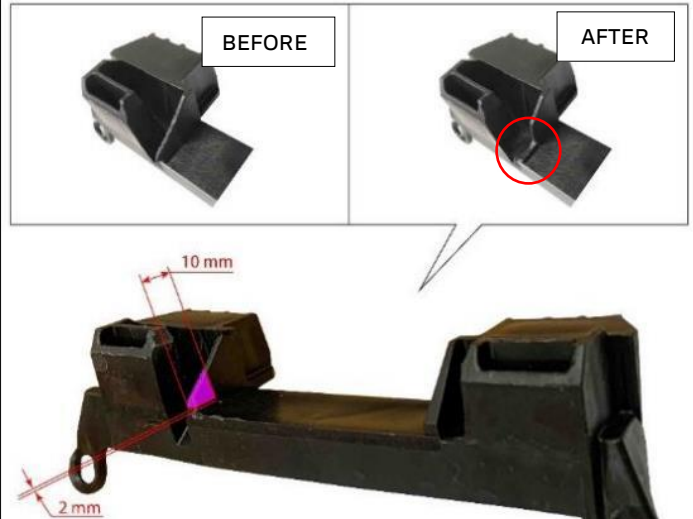
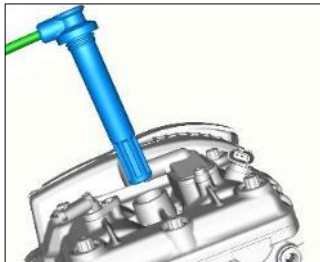

no.	Symptom	Subject	Photo	Notes and Indications - Corrective action
1	<p><u>ONLY</u> <b>Monster Plus MY21 (937cc)</b></p> <p>M5x8 screws are missing from the kit supplied with the vehicle</p>	<p>Kit supplied with the vehicle</p>		<p>We have received a few reports stating that <b>4 M5x8 screws (1)</b> part no. 77240243C required to fix the headlight fairing support bracket to the instrument panel support bracket are missing from the kit supplied with the motorcycle.</p> <p>We would like to inform you that the kits available in stock have all been sorted out.</p> <p>For the headlight fairing assembly procedure and all Pre-delivery operations, please refer to the model introduction bulletin SRV-SRB-21-022.</p> 
2	<p><b>Monster MY21 (937cc)</b> <u>ONLY</u></p> <p>Standard motorcycle lowering and conversion kits now available</p>	<p>Standard motorcycle lowering and conversion kits</p>	<p>-</p>	<p>We hereby inform you that the following kits are now available:</p> <ul style="list-style-type: none"> <li>- Motorcycle lowering kit part no. 96280801AA</li> <li>- Motorcycle lifting kit part no. 96280821AA</li> </ul> <p>The kits include the following dedicated components:</p> <ul style="list-style-type: none"> <li>• a pair of front fork springs</li> <li>• rear shock absorber spring</li> <li>• side stand</li> <li>• side stand retaining nut</li> </ul> <p>Please follow the procedure outlined in the kit or accessories catalogue and the detailed information in the workshop manual.</p> 
3	<p><b>Monster MY21 (937cc)</b> <u>ONLY</u></p> <p>Possibility of unhooking of the rear rider seat fasteners</p>	<p>Rider seat</p>		<p>We have received some reports about the possibility of unhooking the rear fasteners of the rider seat (the two <b>pins (A)</b> on the rear end of the underseat plate come out of from their <b>seats (B)</b> on the rear subframe).</p> <p>We would like to inform you that to avoid the phenomenon described above, the underseat plate has been updated by lengthening the rear fasteners; the new specific part numbers for each country version are indicated below:</p> <ul style="list-style-type: none"> <li>• Part no. 595P6961BA: lowered rider seat (country versions Japan, South Korea and Taiwan)</li> <li>• Part no. 595P6801CA: rider seat</li> </ul> <p>The new seats were introduced into production at the end of May and the spare parts warehouse has been rectified with the new part numbers.</p> 



no.	Symptom	Subject	Photo	Notes and Indications - Corrective action
1	<p><u>ONLY</u> <b>Multistrada 1260</b> <b>(all model versions)</b></p> <p>Possible wrong coupling between rider's seat lower riser and RH side body panel in seat "high configuration"</p>	Rider seat	 	<p>When mounting the rider seat in "high configuration", an excessive gap can be seen between the lower trim and the RH side panel. This is due to interference between the central riser and its support. To avoid such interference and therefore improve the coupling between the rider seat and the side panel, it is necessary to:</p> <ol style="list-style-type: none"> <li>1) Remove the center riser from the seat;</li> <li>2) Working on the RH side support, remove the excess material with a cutter, as shown in the figure.</li> <li>3) Reinstall the center riser to the seat.</li> </ol> 
2	<p><u>ONLY</u> <b>Multistrada 950</b> <b>(all versions)</b></p> <p>Assembly precautions for spark plug cables</p>	Spark plug cables		<p>We have received a few isolated reports of motorcycle downtime due to the detachment of the spark plug cable. We remind you to check the correct assembly of the spark plug cables during the pre-delivery operations and, anyway, before the motorcycle is delivered to the Customer.</p> <p>For correct fitting of spark plug cables, it is necessary to:</p> <ol style="list-style-type: none"> <li>1) Apply Fluorocarbon Gel 880 high viscosity silicone grease in the areas subject to friction during cable insertion on spark plugs. <u>Use as much product as necessary to duly carry out this operation.</u></li> <li>2) Manually insert spark plug cables on the relevant spark plugs by turning the caps to facilitate insertion and making sure they are fully inserted.</li> </ol> 



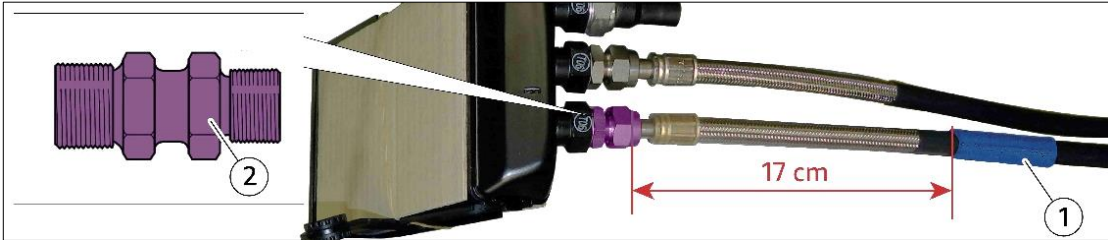



no.	Symptom	Subject	Photo	Notes and Indications - Corrective action
3	<p><u>ONLY</u>  <b>Multistrada 950 MY 17-20</b>  <b>Multistrada 1200 MY 15-17</b>  <b>Multistrada 1260 MY18-20</b>  <b>(all model versions)</b></p> <p>Possible superficial damage to the oil cooler return pipe</p>	Oil cooler pipes		<p>We have received some isolated reports of possible surface damage to the oil cooler return pipe due to rubbing with the top of the coolant radiator, over time. <u>This phenomenon is purely aesthetic and does not affect the correct operation of the system.</u> We inform you that for the models:</p> <p><b>a) Multistrada 1260:</b>  starting from the frame number ZDMAC03AAAKB011354 (on 27/05/2019) the <b>anti-abrasion sheath (1) part no. 4601H701A</b> has been introduced on the oil cooler return pipe, positioned at a distance of <b>17 cm</b> measured from the upper end of the fitting. (This solution is also applicable to all Multistrada 1200 versions Model Year 2015-2017).</p>  <p><b>b) Multistrada 950:</b></p> <ul style="list-style-type: none"> <li>- starting from the frame number ZDMAD00AAKB002259 (on 10/05/2019) the <b>anti-abrasion sheath (1) part no. 4601H701A</b> has been introduced on the oil cooler return pipe, positioned at a distance of <b>17 cm</b> measured from the upper end of the fitting;</li> <li>- starting from the frame number ZDMAD00AALB005691 (on 12/03/2020) the longer <b>fitting (2) part no. 81510391A</b> has been introduced at the oil return pipe outlet from the cooler.</li> </ul>  <p>We ask you to always check the condition of the oil cooler return pipe, and to replace it <b>ONLY</b> if the rubber sheath is damaged and the metallic braided hose can be seen. Follow the assembly notes indicated above according to the reference model. The spare part catalogue has been updated.</p>



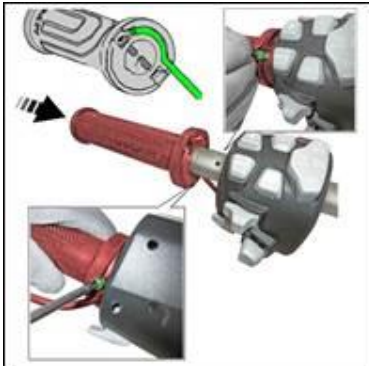

## ← Tips & Tricks – Multistrada Family

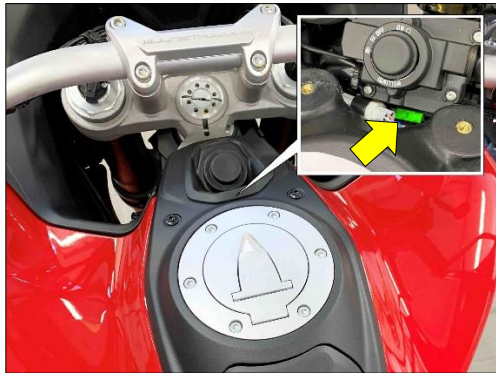



no.	Symptom	Subject	Photo	Notes and Indications - Corrective action
4	<p><b>ONLY</b> <b><u>Multistrada V4</u></b> <b><u>(all model versions)</u></b></p> <p>Precautions during PDI: installation of the heated handgrips part no. 96680702A</p>	<p>Heated handgrips Part no. 96680702A</p>		<p>We have received some reports about heated handgrips that have not been installed correctly and so the cable between the handgrip and the switch may be pinched.</p> <p>We kindly ask you to always follow the instructions provided on the DCS under the "accessories catalogue" section or in the model presentation bulletin (SRV-SRB-20-049) and to <u>comply with the correct orientation of the cable and handgrip</u> as shown in the figure.</p> 
5	<p><b>ONLY</b> <b><u>Multistrada V4</u></b> <b><u>(all model versions)</u></b></p> <p>Precaution during the installation of the heated handgrip kit part no. 96680702A</p>	<p>Heated handgrip kit part no. 96680702A</p>		<p>We inform you that for the installation of the heated handgrip kit part no. 96680702A, the main wiring harness connectors where to connect the heated handgrips, are positioned below the ignition switch cover as shown in the figure.</p> 
6	<p><b>ONLY</b> <b><u>Multistrada V4</u></b> <b><u>(all model versions)</u></b></p> <p>Assembly precaution for the anti-theft system kit part no. 96681081AA</p>	<p>Anti-theft system kit part no. 96681081AA</p>		<p>We inform you that for the installation of the anti-theft system kit part no. 96681081AA, the <b>main wiring connector (1)</b> where to connect the anti-theft device, is positioned near the fuel pump flange, in the front left area of the fuel tank.</p> 



## ← Tips & Tricks – Multistrada Family

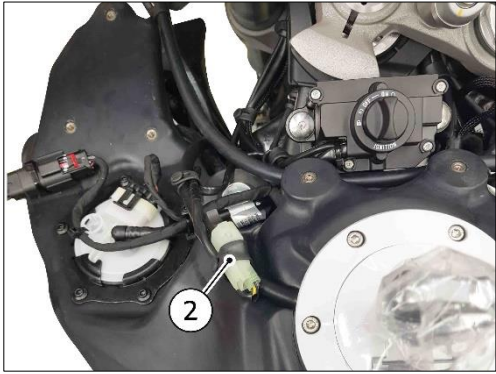

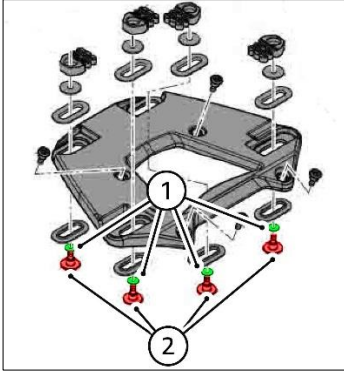
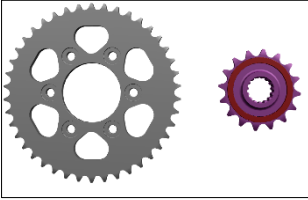



no.	Symptom	Subject	Photo	Notes and Indications - Corrective action
7	<p><b>ONLY</b> <b><u>Multistrada V4</u></b> <b><u>(all model versions)</u></b></p> <p>Assembly precaution for the fuel tank cap kit Hands Free part no. 96681021AA</p>	Hands Free fuel tank cap kit part no. 96681021AA		<p>We inform you that for the installation of the Hands Free fuel tank cap kit part no. 96681021AA, the <b>main wiring connector (2)</b> where to connect the Hand Free fuel tank cap, is positioned near the fuel pump flange, in the front left area of the fuel tank.</p> 
8	<p><b>ONLY</b> <b><u>Multistrada V4</u></b> <b><u>(all model versions)</u></b></p> <p>Possible incorrect operation of the swinging system - Top Case accessory kit part no. 96781531AA</p>	Top Case Part no. 96781531AA		<p>We inform you that the first Top Case accessory kits part no. 96781531AA delivered may not operate correctly with the swinging system, which may seem "too braked". To improve this condition, it is possible to insert <b>4 copper washers (1) part no. 85250231A</b> on the <b>4 screws (2)</b> retaining the bottom plate to the top one.</p> <p>For a better understanding of the assembly procedure of the Top Case accessory kit, a video has been made which can be viewed at the following link: <a href="https://youtu.be/DVEHKVvdKQI">https://youtu.be/DVEHKVvdKQI</a>.</p> <p>All Top Case kits in stock will be restored by February 2021.</p> 
9	<p><b>ONLY</b> <b><u>Multistrada V4</u></b> <b><u>(all model versions)</u></b></p> <p>Ducati Quick Shift (DQS) malfunctioning and no indication on the instrument panel of the engaged gear</p>	Final drive		<p>We have received isolated reports about the Ducati Quick Shift (DQS) not working properly, and about the missing indication of the engaged gear on the instrument panel, with <b>gear sensor plausibility error P0919</b> being stored (the gear plausibility diagnosis requires 16 seconds of validation at a speed above 20 km/h without any gear change).</p> <p>Some analyses showed that this condition occurred following a change in the final drive gear ratio (Z15 sprocket installed instead of Z16 as designed).</p> <p><u>As already emphasized during the technical training, we remind you to avoid any modification to the final drive gear ratio (Z16 sprocket and Z42 rear sprocket).</u></p>



## ← Tips & Tricks – Multistrada Family



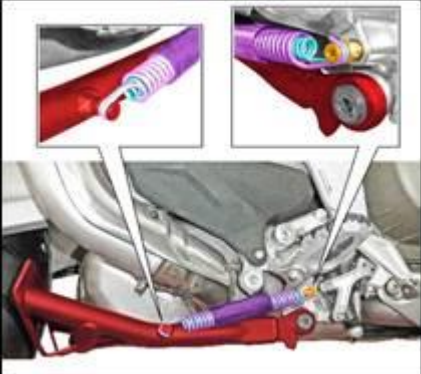

no.	Symptom	Subject	Photo	Notes and Indications - Corrective action
10	<p><b>ONLY</b> <b>Multistrada V4</b> <b>(all model versions)</b></p> <p>Difficulties in opening the side panniers part no. 96781551AA</p>	<p>Side panniers part no. 96781551AA</p>		<p>We have received a few isolated reports of possible difficulties in opening the side panniers due to the “vacuum” effect that occurs when travelling with significant changes in altitude.</p> <p>To avoid this phenomenon, it is necessary to drill a venting hole with a maximum diameter of Ø 2 mm at the bottom of the bag, between the ribs near the rear hinge as shown in the figure.</p> <p><b><u>DO NOT drill through the second internal wall of the bag.</u></b></p> <p>This modification has also been implemented by the supplier and does not affect the water tightness.</p>  
11	<p><b>ONLY</b> <b>Multistrada V4</b> <b>(all model versions)</b></p> <p>Possible interference between external central stand return spring and footpeg holder plate</p>	<p>Central stand</p>		<p>We have received a few isolated reports of possible interference between the external central stand return spring and the footpeg holder plate when the central stand is closed.</p> <p>We kindly ask you to check that the two side stand return springs are correctly installed and aimed as shown in the figure.</p> 



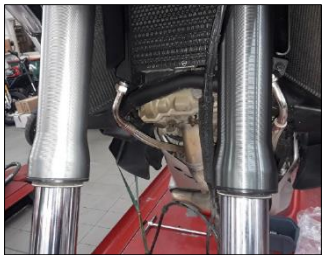

## ← Tips & Tricks – Multistrada Family



no.	Symptom	Subject	Photo	Notes and Indications - Corrective action
12	<p><b>ONLY</b> <b><u>Multistrada V4</u></b> <b><u>(all model versions)</u></b></p> <p>Possible switching on of DSS warning light on instrument panel</p>	Ducati Skyhook Suspension (DSS)	-	<p>There have been some isolated reports regarding a possible switching on of the “DSS” warning light  on the instrument panel for the models equipped with Ducati Skyhook Suspension <u>without any errors read by the diagnosis instrument.</u></p> <p>Through the DDS 3.0 diagnosis instrument, enter the “Settings” section of the BBS control unit and perform the “Calibration of the rear rotary sensor”.</p>
13	<p><b><u>Multistrada V4S, ONLY</u></b></p> <p>Coloring of the spare front fork sleeve</p>	Front forks		<p>We have received several reports of a different coloring of the fork sleeve ordered as a spare part for a complete fork leg replacement. This is due to an anodizing process with different color rendering.</p> <p>In case of replacement of a complete fork leg, previously authorized by your Service Area Manager, we ask you to check the correct color of the fork leg before assembly (comparing it with the color of the fork installed on the motorcycle) and if it is different, update the <b>Youtech</b> service request by attaching photos and urgently ordering the other complete fork leg to proceed with its replacement.</p> <p>Please, note that the spare part warehouse will be restored.</p>
14	<p><b>ONLY</b> <b><u>Multistrada V4</u></b> <b><u>(all model versions)</u></b></p> <p>Precautions for checking the engine oil level</p>	Level engine oil		<p>To correctly check the engine oil level, carefully follow the operations described below:</p> <ol style="list-style-type: none"> <li>1) The level check should be carried out with warm engine, approximately 15 minutes after the engine has been turned off.</li> <li>2) Turn off the engine and wait 10÷ 15 minutes to allow the oil to return completely to the oil sump.</li> <li>3) Position the motorcycle on level ground with both wheels on the ground and in an upright position.</li> <li>4) Check the oil level through the sight glass.</li> </ol> <p>If the oil level is below the center line between the MIN and MAX notches, add oil up to the maximum level notch.</p>



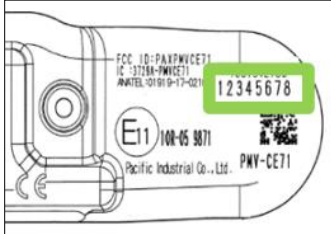

no.	Symptom	Subject	Photo	Notes and Indications - Corrective action
15	<p align="center"><b>ONLY Multistrada V4 (all model versions)</b></p> <p>Activation procedure for TPMS tire pressure sensor</p>	<p align="center">TPMS (Tire Pressure Monitoring System)</p>		<p>The TPMS system (Tire Pressure Monitoring System) allows monitoring tire pressure value: if tire pressure deviates by 25% from the set reference value, the TPMS system displays a warning on the instrument panel. The sensor activates when speed exceeds 35 km/h and tire pressure is displayed on the instrument panel 1 minute later.</p> <p><u>We remind you that, before installing tire pressure sensors on front and rear wheel rims, they must be coded through DDS 3.0 diagnosis instrument.</u></p> <p>To activate TPMS system, follow the procedure indicated below:</p> <ol style="list-style-type: none"> <li>1) using DDS 3.0, access the "Special Features → Ducati Accessories Manager → Vehicle Configuration";</li> <li>2) select "Enable/Disable" TPMS;</li> <li>3) access the "Self-diagnosis → Settings" section of Hands Free control unit and perform "TPMS code writing" for front and rear wheel sensors by entering the 8-digit code written above the Qr-Code;</li> <li>4) access the instrument panel Settings menu and select "Tire Pressure" to set (and customize) the reference pressure values of the rear and front tires. The tire nominal pressure value specified inside the owner's manual can be used as a reference.</li> </ol> <p><u>Explain to the Customer the use of the "Tire Pressure" function to edit the reference pressure value of the front and rear tires. The information about the current pressure value of front and rear tires is also available inside instrument panel main menu.</u></p> 
16	<p align="center"><b>ONLY Multistrada V4 (all model versions)</b></p> <p>Possible erratic idling rpm and hard starting</p>	<p align="center">Engine</p>		<p>We have received a few isolated reports of erratic engine operation at idle, hard starting, the possibility of the MIL warning light on the instrument panel coming on and/or memorized MAP sensor errors.</p> <p>Our analysis has shown that this phenomenon could be due to the MAP sensors not fitting perfectly in their seats; we therefore ask you to check the correct installation of the MAP sensors if the symptoms described above should occur.</p> <p>We would also like to inform you that the assembly process of MAP sensors on the production line has been strengthened from the end of April 2021.</p>



## ◀ Tips & Tricks – Multistrada Family



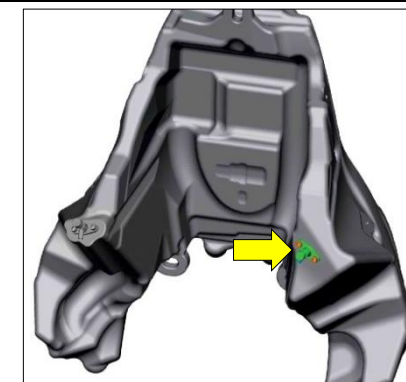

no.	Symptom	Subject	Photo	Notes and Indications - Corrective action
17	<p><b>ONLY</b> <b><u>Multistrada V4S</u></b></p> <p>Instrument panel programming interruption</p>	Instrument Panel Programming		<p>The programming procedure must be carried out <b>ONLY</b> when the motorcycle is connected to the special Ducati power supply unit Part no. 979000286.</p> <p><u>If programming is not completed successfully, the instrument panel will NOT be damaged and it will never have to be replaced.</u></p> <p>To restore instrument panel correct operation, you will have to:</p> <ol style="list-style-type: none"> <li>1) Turn off or disconnect the workshop power supply unit;</li> <li>2) Switch the motorcycle from Hands Free to Key-OFF;</li> <li>3) Disconnect the USB cable from PC to motorcycle;</li> <li>4) Wait for 60 seconds;</li> <li>5) Remove the 50 Ampere fuse (the one on tank side);</li> <li>6) Wait for 30 seconds;</li> <li>7) Re-connect the 50 Ampere fuse;</li> <li>8) Re-connect or turn on again the battery power supply unit;</li> <li>9) Switch the motorcycle from Hands Free to Key-ON and connect the DDS 3.0 diagnosis instrument;</li> <li>10) If the instrument panel resumes normal operation by showing the display, select the "Global Scan" function and programming will automatically restart;</li> <li>11) If the instrument panel remains in the "bootloader" status with LH warning lights flashing, select the "SERVICE UPDATE Multistrada V4S" model and "Bosch → Model Year 21 instrument panel reprogramming", select the file present (e.g. 1706_ICC_S018) and launch the programming; connect the USB cable to the motorcycle when requested by the DDS 3.0;</li> <li>12) Programming will restart and will take approximately 20 minutes.</li> </ol> <p>A video has been made, which can be viewed on the <b>YouTube</b> platform at the following link: <a href="https://youtu.be/c9br35tEazg">https://youtu.be/c9br35tEazg</a>.</p>
18	<p><b>ONLY</b> <b><u>Multistrada V4</u></b> <b><u>(all model versions)</u></b></p> <p>Incorrect residual fuel in the tank</p>	Fuel tank	-	<p>In some cases, we have found that the tap on the right-hand side of the fuel tank is completely closed instead of open; this leads to an incorrect remaining range when there are only a few liters of fuel in the tank (fuel reserve conditions).</p> <p>If the above-mentioned event occurs, we ask you to ensure that the tap on the right-hand side of the fuel tank is fully open</p>





## ← Tips & Tricks – Multistrada Family



no.	Symptom	Subject	Photo	Notes and Indications - Corrective action
19	<p><b>ONLY</b> <b><u>Multistrada V4</u></b> <b><u>(all model versions)</u></b></p> <p>Possible oscillation of the final drive chain (non-uniform sliding)</p>	Gearbox secondary shaft	-	<p>We have received some isolated reports about a possible oscillation of the final drive chain even if the chain is correctly tensioned. In these cases the customer may complain an uneven sliding of the chain at constant speed.</p> <p>In these cases, you are asked to check for a possible deformation of the gearbox secondary shaft by removing both the chain and the sprocket and taking the measurement with a dial gauge directly on spacer Part no. 713P0011C, as shown in the figure (the measurement should NOT be taken on the sprocket since an uneven wear of the rubber material may occur during the first few kilometers): by slowly rotating the shaft, the value taken with the dial gauge must be at most 0.1 mm.</p> <div style="display: flex; justify-content: space-around; align-items: center;">   </div> <p>a) If the measurement shows values below 0.1 mm, replace the sprocket only. a) If the measurement shows a value greater than 0.1mm, fill out a <b>Youtech</b> service request.</p>
20	<p><b>ONLY</b> <b><u>Multistrada V4</u></b> <b><u>(all model versions)</u></b></p> <p>Possible validation of errors P0326 - Front bank knock sensor error (Cyl 1-2) [Mismatching value] and/or P0331 - Rear bank knock sensor error (Cyl 3-4) [Mismatching value]</p>	Knock sensor	-	<p>We have received a few isolated reports about the triggering of one of the following errors in the engine ECU, either in ACTIVE or STORED status:</p> <ul style="list-style-type: none"> <li>- P0326 - Front bank knock sensor error (Cyl 1-2) [Mismatching value]</li> <li>- P0331 - Rear bank knock sensor error (Cyl 3-4) [Mismatching value]</li> </ul> <p>that cause only the <b>MIL</b> warning light to light up on the instrument panel, without affecting the correct operation of the vehicle (no vehicle stop).</p> <p>If one or both errors are displayed, we kindly ask you to:</p> <ul style="list-style-type: none"> <li>• Check the correct tightening of the knock sensor fixing screw (25 Nm);</li> <li>• Use an Ohmmeter to check the resistance between the pins of the knock sensor involved: Resistance nominal value: <b>4.9 MΩ ±20%</b></li> </ul> <p>If the value does not correspond, replace the sensor and send the defective component to Ducati Motor Holding.</p> 

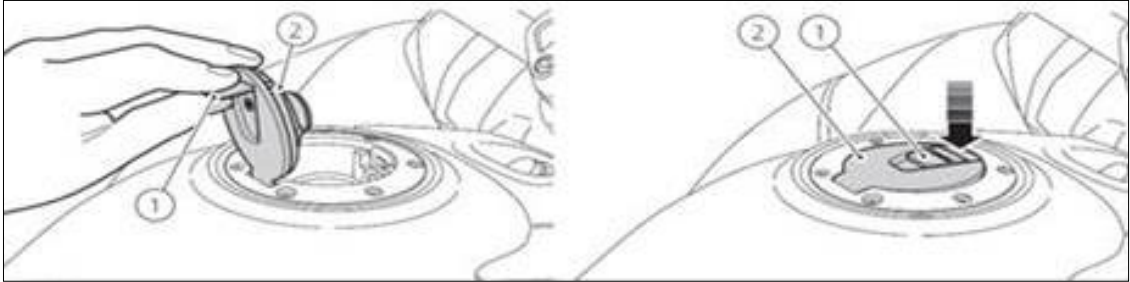

no.	Symptom	Subject	Photo	Notes and Indications - Corrective action
21	<p><b>ONLY</b> <b>Multistrada V4S,</b> <b>Multistrada V4S Sport</b></p> <p>Precautions for the use of the Hands Free fuel tank cap part no. 96681021AA</p>	Hands Free fuel tank cap part no. 96681021AA		<p>We have received a few isolated reports concerning the hands free fuel cap part no. 96681021AA that proves difficult to open and/or close. DO NOT REPLACE THE FUEL TANK CAP.</p> <p><b>Hands-free tank filler plug</b> The hands-free tank filler plug allows the cap to be opened during refueling without using a key.</p> <p><b>Opening</b> To open the cap, the suitable flap must be lifted within 50 seconds of turning the vehicle off (key off). During those 50 seconds, the cap can be opened a maximum of 5 times. If a new opening is desired, the key must be turned on and then back off (key-on &gt;&gt; key-off).</p> <p><u>Caution: the opening flap must be operated gently. Excessively fast movements may impair the cap opening, even though the attempt will still be counted among the 5 available.</u></p> <p><b>Information on instrument panel</b> The instrument panel has an icon indicating “fuel cap open”. If the instrument panel is turned on (key-on) while the cap is open, the icon will be active.</p> <p><b>Closing</b> To close the cap, use your fingers to push it in fully home.</p> <p><u>Caution: After refueling, always ensure that the cap is correctly positioned and closed and that the corresponding icon on the instrument panel is off.</u></p>  <p>For a further understanding of how it works, a video was also made available at the following link: <a href="https://youtu.be/aCmACKVICWl">https://youtu.be/aCmACKVICWl</a>.</p>



## ← Tips & Tricks – Multistrada Family



no.	Symptom	Subject	Photo	Notes and Indications - Corrective action
22	<p><b>ONLY</b>  <u>Multistrada V4S</u>  <u>Multistrada V4S Sport</u></p> <p>Error C1134 – High DRL temperature</p>	Headlight	-	<p>We have received some reports concerning the display of error “C1134 - High DRL temperature” for which the generic Error warning light, linked to the specific malfunction of the DRL inside the headlight, would normally light up on the instrument panel.</p> <p>The error refers to an actual circuit overheating problem which, in the event of prolonged use, could lead to damage to the DRL function only (the headlight low beam and high beam would still work normally).</p> <p>If error “C1134 - High DRL temperature” is displayed, we kindly ask you to:</p> <ul style="list-style-type: none"> <li>- Check the production date printed on the upper left side of the headlight</li> </ul> <div data-bbox="1294 528 1957 943" data-label="Image"> </div> <p>the first two digits correspond to the month, the next two digits correspond to the day and the following two digits correspond to the year. The last two digits correspond to an internal code that never changes. E.g. code in figure 02222110</p> <div data-bbox="1397 1074 1886 1315" data-label="Diagram"> </div> <ul style="list-style-type: none"> <li>- If the date is prior to 23 March 2021, replace the headlight and returning the item to Ducati</li> <li>- If the date is the same or after 23 March, inform your Area Manager with a specific Youtech, explicitly indicating the date on the headlight, and attaching, if possible, any photographic documentation.</li> </ul>







## ◀ Tips & Tricks – Multistrada Family



no.	Symptom	Subject	Photo	Notes and Indications - Corrective action
23	<p><b><u>Multistrada V4S, ONLY</u></b></p> <p>Failure to recognize mobile phone on instrument panel</p>	Instrument panel	-	<p>We have received a few isolated reports that the mobile phone is not recognized on the instrument panel and, therefore, cannot be connected via Bluetooth.</p> <p><u>Replacement of the instrument panel is NOT required as it is not an issue related to the hardware of the vehicle.</u></p> <p>In this case, we suggest:</p> <ul style="list-style-type: none"><li>- deleting the previously established connection from both the Customer's mobile phone and the vehicle instrument panel;</li><li>- performing a Key-Off and wait for at least 1 minute before the next Key-ON;</li><li>- repeating the pairing operations between the mobile phone and the instrument panel.</li></ul> <p>If the issue persists, fill out a <b>Youtech</b> service request attaching the completed Infotainment Check List.</p>
24	<p><b><u>Multistrada V4S, ONLY</u></b></p> <p>No "key missing" message displayed on the instrument panel</p>	Hands Free	-	<p>We have received a few isolated reports that the "key missing" message is not displayed on the instrument panel if the key is out of range of the Hands Free antenna.</p> <p>We inform you that this case is being analyzed.</p>
25	<p>Possible lack of paint adhesion on fuel tank cap</p>	Fuel tank cap		<p>We would like to inform you that on an initial batch of motorcycles produced, the fuel tank cap could present a problem of paint adhesion. Starting from frame number ZDM1A00AAMB002445 the supplier has improved the painting process that avoids this issue.</p> <p>The fuel tank caps in the spare part warehouse are compliant.</p>

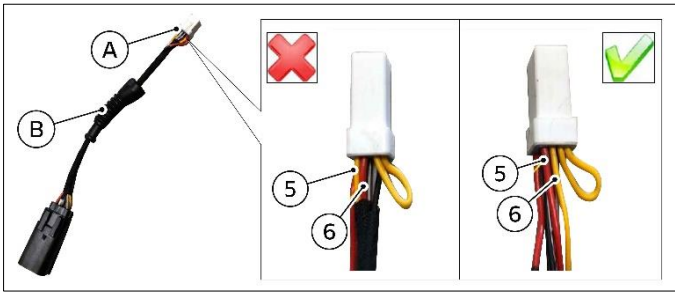

no.	Symptom	Subject	Photo	Notes and Indications - Corrective action
26	Issues during Top Case fixing to the plate	Top Case Kit Part no. 96781531AA		<p>We have received some reports concerning the difficulty in securing the Top Case (Kit Part no. 96781531AA) to the top plate Part no. 8291M033A due to a machining error of the supplier. In particular, the locking tooth on the upper plate Part no. 8291M033A shows a hole 2mm narrower than specified. To eliminate this defect, the locking tooth of the plate must be milled by <u>2mm in the upper area</u> using a flat file, as shown in the figure.</p> <p>We inform you that the upper plates present inside the kits in stock have been restored.</p>
27	Anti-theft system kit Part no. 96681081AA malfunction	Anti-theft system kit Part no. 96681081AA		<p>After having installed the anti-theft system Kit Part no. 96681081AA and enabled it on the BBS control unit, some malfunctions may occur during activation due to a possible incorrect pin arrangement in the connector of the wiring branch supplied with the kit.</p>  <p>Follow the procedure described below:</p> <ol style="list-style-type: none"> <li>1) uncover <b>connector (A)</b> by moving <b>sheath (B)</b> backward;</li> <li>2) uncover the wiring by removing a portion of insulating tape to make operations easier;</li> <li>3) check the arrangement of <b>Pins 5 and 6</b> and the relevant color on the 8-pin connector. If the pin arrangement is not correct, extract them working from the front side with a needle inside the groove so as to lift the retainer and invert them.</li> <li>4) restore the cloth tape previously removed and the position of the protective <b>sheath (B)</b>.</li> </ol>  <p>The kits currently in stock have been restored.</p>



## ◀ Tips & Tricks – Multistrada Family



no.	Symptom	Subject	Photo	Notes and Indications - Corrective action
28	<p><b>ONLY</b> <b>Multistrada V4S</b></p> <p>Software updates for Bosch instrument panel with DDS 2.0 diagnosis instrument</p>	Software updates for Bosch instrument panel	-	<p>The new DDS 3.0 diagnosis instrument kits Part no. 979000279 are being distributed and will be delivered within the next few months.</p> <p>We would like to remind you that in order to carry out software updates of the Multistrada V4S instrument panel, it is necessary to use the USB cable included in the DDS 3.0 diagnosis instrument kit.</p> <p>If you have not received the new diagnosis instrument yet, you can still perform the update using the DDS 2.0 using any <u>USB cable, type A male-male</u> (this cable is easily available on the market).</p> <p>We also inform you that a video has been made showing you the correct use of the cable. It can be viewed at the following YouTube link: <a href="https://youtu.be/IGbLKyo4B8k">https://youtu.be/IGbLKyo4B8k</a>.</p>
29	Precautions during PDI: installation of the battery on the vehicle	Battery assembly		<p>We have received isolated reports of possible issues concerning the connection of battery negative cable; in particular, you may find that the negative cable appears to be too long.</p> <p><u>To correctly position the battery negative cable, make sure that the cable runs over the main wiring and makes a bend upstream of the battery negative pole.</u></p> <p>For a better understanding, we have made a short video showing the issue described above and the correct battery installation, which can be viewed at the following link: <a href="https://youtu.be/wu1qH4gi4Ll">https://youtu.be/wu1qH4gi4Ll</a>.</p>





no.	Symptom	Subject	Photo	Notes and Indications - Corrective action
30	<p style="text-align: center;"><b>ONLY</b> <b><u>Multistrada V4S</u></b></p> <p>Right-hand switch button backlighting</p>	<p>Right-hand handlebar control switches</p>		<p>We have received some reports on the right-hand handlebar control switches replaced under warranty - which we have subsequently found to be correctly operating - due to backlighting problems.</p> <p>In case of backlighting problems on the right-hand handlebar control switch, we would like to ask you to carry out the following check before replacing the whole switch:</p> <ul style="list-style-type: none"> <li>• Disconnect the connector from the right-hand switch</li> <li>• Using a multimeter [preferably with thin test prods to ensure good electrical contact with the internal pins (insert two metal needles if necessary)] and with the ignition on, measure the voltage present across pins 1 and 2 on the connector on wiring side</li> <li>• If the voltage measured is approximately equal to battery voltage value (around 12-13V), the absence of backlighting is due to an internal problem of the switch, which must therefore be replaced.</li> <li>• If the measured voltage is zero or very low, the problem is not inside the switch, which therefore does not need to be replaced</li> <li>• Since the backlighting is powered by the left-hand switch, in this case:             <ol style="list-style-type: none"> <li>1. Disconnect the connector from left-hand switch</li> <li>2. Use a multimeter to check for signal continuity across pin 4 of the left-hand switch connector (wiring side) and pin 2 of the right-hand switch connector (wiring side)</li> </ol> </li> </ul> <div style="text-align: center;"> </div> <ol style="list-style-type: none"> <li>3. If there is no continuity, the problem is probably due to an open circuit within the wiring or on the pins of one of the two connectors</li> <li>4. If continuity is present, the problem could be directly caused by the left-hand switch not supplying power correctly: please report the problem through a dedicated Youtech request</li> </ol>



## ← Tips & Tricks – Multistrada Family



no.	Symptom	Subject	Photo	Notes and Indications - Corrective action
31	<p><b><u>Multistrada V4S</u></b> <b>ONLY</b></p> <p>Possible appearance of stains and white dots on the instrument panel</p>	Instrument panel glass		<p>We have received some isolated aesthetic reports of possible stains, white dots or halos on the instrument panel glass.</p> <p><u>Do not to replace</u> the instrument panel under any circumstances and to remove any stains with a dry microfiber cloth without any type of additive, cleaning the display glass firmly, as it is highly resistant to scratching. Alternatively, you can slightly dampen the microfiber cloth with water, remembering to carefully wipe the glass with a dry cloth or paper to avoid the formation of halos.</p>
32	<p><b><u>Multistrada V4S</u></b> <b>ONLY</b></p> <p>Possible malfunction of the heated passenger seat</p>	Heated passenger seat	  	<p>We have received some isolated reports on the possible malfunction of the heated passenger seat when switch is set to position 1 or 2.</p> <p>The analyses carried out revealed that this phenomenon could be due to a loose connection between the switch and the relevant connector or to the malfunction of the switch itself.</p> <p>We ask you to check the switch connection by removing the 4 retaining screws of the switch cover. After checking that the electrical connection is correct, reinforce it using a small self-locking tie. If the problem is not solved as described above, replace only the switch with <b>Part no. 53910531A</b>. Please send a <b>Youtech</b> report and do not replace the heated passenger seat completely.</p>





## ◀ Tips & Tricks – Multistrada Family



no.	Symptom	Subject	Photo	Notes and Indications - Corrective action
33	<p><b><u>Multistrada V4S</u></b> <b>ONLY</b></p> <p>Upcoming Infotainment and HMI improvements</p>	Infotainment System and User Interface (HMI)		<p>In anticipation of the information that may be provided during the upcoming Global Dealer Conference, we believe it would be appropriate to share with you the main improvements to the Infotainment and User Interface (HMI) system that will soon be available, <b>indicatively towards the end of this year</b> (some developments are being tested jointly with suppliers), both with new instrument panel software updates and with updates to the Ducati Connect and Sygic Navigator Apps.</p> <p><b>This information will be disclosed to all customers at the appropriate time.</b> For now, we kindly ask you to keep it confidential.</p> <p>The <b>main new features</b> will include:</p> <ul style="list-style-type: none"> <li>• <b>the possibility of keeping the connection with Ducati Connect active for up to 20 minutes after the key off.</b> Basically, when the vehicle is turned off, a dedicated indication will appear on the instrument panel, inviting you to press the Joystick if you want to keep the connection active: in this way, when restarting after a short stop, Ducati Connect will be immediately available without any waiting time.</li> <li>• <b>a new management of music and navigation audio volume</b> that, in addition to acting directly on the audio system of the smartphone via the switch joystick, will also display the level set on the instrument panel.</li> <li>• <b>a new management of calls during navigation mirroring:</b> in the event of an outgoing call made by Ducati Connect, it will be possible to go back or to go to the navigation screen of the vehicle.</li> <li>• <b>the possibility to use the Phone and Music Player features even in Enduro and Sport Riding Modes.</b></li> <li>• <b>a new management of heated handgrips: the activation and adjustment of handgrip heating will be possible by simply using only the dedicated button on the right-hand switch</b> and it will no longer be necessary to access the dedicated menu using the joystick on the left-hand switch.</li> </ul>



## ◀ Tips & Tricks – Multistrada Family



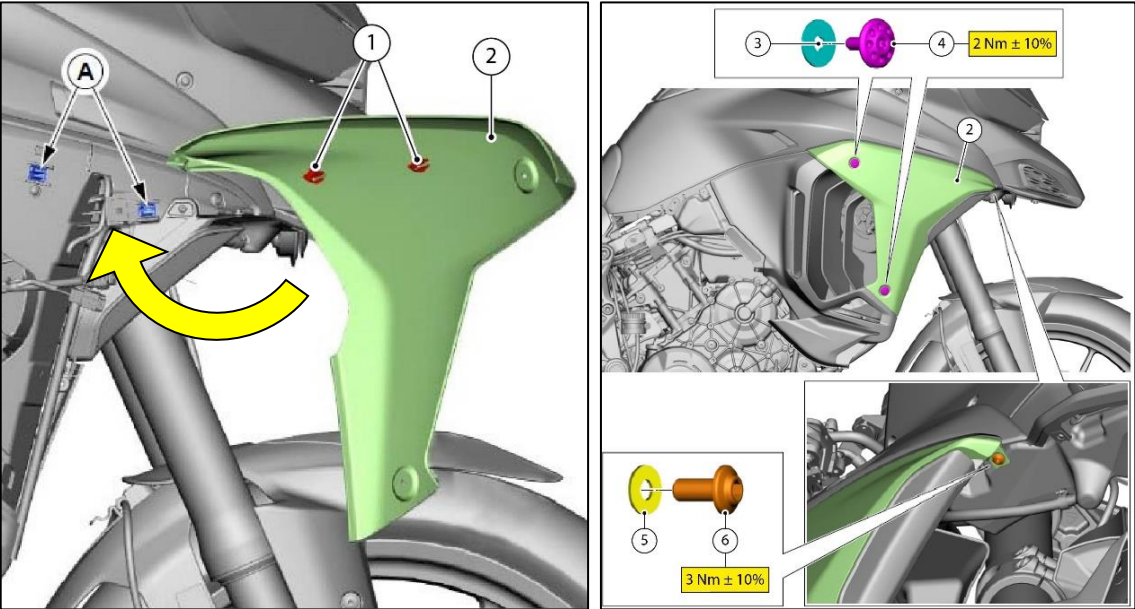

no.	Symptom	Subject	Photo	Notes and Indications - Corrective action																		
34	<p><b><u>Multistrada V4</u></b> <b><u>(all model versions)</u></b> <b>ONLY</b></p> <p>Installing the RH and LH side cowlings during PDI</p>	RH and LH side cowlings		<p>We would like to inform you that from approx. 1 Nov 2021, in order to avoid transport damage to the cowlings of the Multistrada V4, the kit supplied will also include the RH side cowling, the LH side cowling and the relevant hardware, which you must install during PDI. For this reason we also updated the <a href="#">PDI Checklist SRV-SRB-20-049_PDI Checklist for Multistrada V4 Rev.02</a>.</p> <p>The additional kit will include:</p> <table border="1" data-bbox="1406 464 1848 659"> <thead> <tr> <th>Description</th> <th>Part no.</th> <th>Qty</th> </tr> </thead> <tbody> <tr> <td>RH cowling</td> <td>4801A901AA</td> <td>1</td> </tr> <tr> <td>LH cowling</td> <td>4801A911AA</td> <td>1</td> </tr> <tr> <td>Special screw</td> <td>7791C311AB</td> <td>4</td> </tr> <tr> <td>Screw</td> <td>77244173B</td> <td>2</td> </tr> <tr> <td>Clip</td> <td>85044631A</td> <td>4</td> </tr> </tbody> </table> <p>When assembling, fit clips (1) on brackets of cowlings (2). Install cowlings (2) and engage clips (1) in the corresponding housings (A). Tighten the special screws (4) to 2 Nm <math>\pm</math> 10% and the screw (6) to 3 Nm <math>\pm</math> 10%.</p> 	Description	Part no.	Qty	RH cowling	4801A901AA	1	LH cowling	4801A911AA	1	Special screw	7791C311AB	4	Screw	77244173B	2	Clip	85044631A	4
Description	Part no.	Qty																				
RH cowling	4801A901AA	1																				
LH cowling	4801A911AA	1																				
Special screw	7791C311AB	4																				
Screw	77244173B	2																				
Clip	85044631A	4																				



## ← Tips & Tricks – Multistrada Family

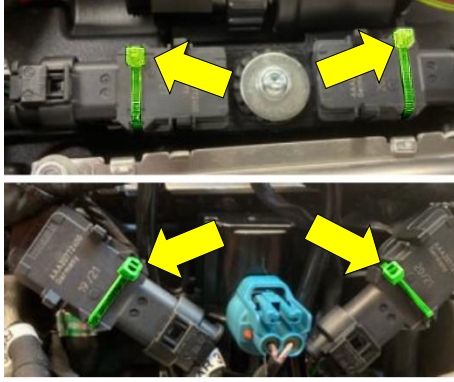

no.	Symptom	Subject	Photo	Notes and Indications - Corrective action
35	<p><b>ONLY</b> <b><u>Multistrada V4</u></b> <b><u>(all model versions)</u></b></p> <p>Possible erratic idling rpm and hard starting</p>	Engine		<p>We have received a few isolated reports of erratic engine operation at idle, hard starting, the possibility of the MIL warning light on the instrument panel coming on and/or memorized MAP sensor errors or P061B Torque Monitoring error.</p> <p>Our analysis has shown that this phenomenon could be due to the MAP sensors not fitting perfectly in their seats; we therefore ask you to check the correct installation of the MAP sensors if the symptoms described above should occur, and to fix them properly using self-locking ties positioned as shown in the figure.</p> <p>Create a Youtech for any cases found in your dealership. Attach PDF copy of the DDS Fault Report (with freeze frame parameters) and photos of the MAP sensor(s) as discovered during inspection and after with self-locking ties.</p> 
36	<p><b><u>Multistrada V4S</u></b> <b>ONLY</b></p> <p>Upcoming Infotainment and HMI improvements</p>	Infotainment System and User Interface (HMI)		<p>These are the main improvements to the Infotainment and User Interface (HMI) system that will soon be available, <b>indicatively towards the end of this year</b> (some developments are being tested jointly with suppliers), both with new instrument panel software updates and with updates to the Ducati Connect and Sygic Navigator Apps.</p> <p><b>This information will be disclosed to all customers at the appropriate time.</b> This information is confidential and not to be shared.</p> <p>The <b>main new features</b> will include:</p> <ul style="list-style-type: none"> <li>• <b>the possibility of keeping the connection with Ducati Connect active for up to 20 minutes after the key off.</b> Basically, when the vehicle is turned off, a dedicated indication will appear on the instrument panel, inviting you to press the Joystick if you want to keep the connection active: in this way, when restarting after a short stop, Ducati Connect will be immediately available without any waiting time.</li> <li>• <b>a new management of music and navigation audio volume</b> that, in addition to acting directly on the audio system of the smartphone via the switch joystick, will also display the level set on the instrument panel.</li> <li>• <b>a new management of calls during navigation mirroring:</b> in the event of an outgoing call made by Ducati Connect, it will be possible to go back or to go to the navigation screen of the motorcycle.</li> <li>• <b>the possibility to use the Phone and Music Player features even in Enduro and Sport Riding Modes.</b></li> <li>• <b>a new management of heated handgrips: the activation and adjustment of handgrip heating will be possible by simply using only the dedicated button on the right-hand switch</b> and it will no longer be necessary to access the dedicated menu using the joystick on the left-hand switch.</li> </ul> <p>the <b>New Minimum Preload semi-automatic function</b> that will allow you to set the rear shock absorber to the minimum (from the handlebar lock), reducing the height of the vehicle to <b>make it easier to put your feet on the ground during city use.</b></p>





## ◀ Tips & Tricks – Multistrada Family



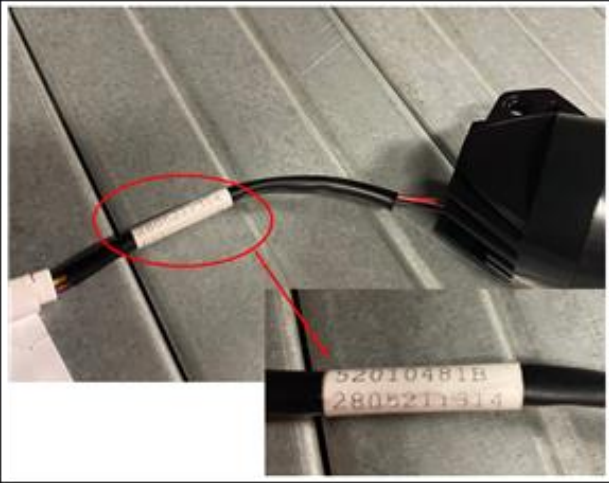

no.	Symptom	Subject	Photo	Notes and Indications - Corrective action
37	<p><b><u>Multistrada V4S</u></b> <b>ONLY</b></p> <p>Information e-mail sent to customers about upcoming improvements.</p>	<p>New comfort features / Infotainment System and User Interface (HMI)</p>	-	<p>Dear colleagues, we would like to inform you that from Monday 22 November, all customers owning a Multistrada V4S will receive communication by e-mail or through the MyDucati App informing them about the availability of all the new features contained in the updated TIPS MTS V4S number 26 from next January onwards.</p> <p>In order to have these new contents available, the Bosch instrument panel software and the BBS control unit software must be updated. The software is currently completing the validation stage and, as soon as available to the Dealers, customers will be informed so that they can make an appointment.</p> <p><u>The contents are only available for the MTS V4 S version and not for the Base version.</u></p>
38	<p><b>ONLY</b> <b><u>Multistrada V4</u></b> <b>(all model versions)</b></p> <p>Possible oscillation of the final drive chain (non-uniform sliding)</p>	<p>Gearbox secondary shaft</p>	-	<p>We have received some isolated reports about a possible uneven tensioning of final drive chain even if the chain is correctly tensioned and has no stretched sections.</p> <p>Should you detect this issue, please:</p> <ul style="list-style-type: none"> <li>● Check chain stretching on several sections using tool Part no. 889450134 (see bulletin <a href="#">SRV-SRB-20-050</a>)</li> <li>● Tension the chain</li> <li>● Check chain travel in several sections (see bulletin <a href="#">SRV-SRB-20-050</a>)</li> <li>● Should tension still be present, check bike frame number and, if it is earlier than: <ul style="list-style-type: none"> <li>➤ For vehicles manufactured in Bologna: <b>ZDM1A00AANB012280</b></li> <li>➤ For vehicles manufactured in Thailand: XXXXX</li> </ul> </li> </ul> <p>replace the front sprocket only, since we found out that in some cases tooth machining is not concentric with the keying on the secondary shaft.</p> <p>The issue has been solved starting from the frame numbers specified above and the available spare parts have been restored.</p>



no.	Symptom	Subject	Photo	Notes and Indications - Corrective action
39	<p><u>Multistrada V4, ONLY</u> <u>(all versions)</u></p> <p>Possible water infiltration into the fog lights</p>	Fog lights		<p>We have received some reports of unusual infiltration of water into the LED supplementary lights, which are available as spare parts – accessory part no.: <b>96681031AA</b>. For this reason, the supplier has introduced some considerable improvements in the assembly, which should avoid the problem. In case of an unusual presence of water, please check the manufacturing date indicated on the label on the wiring:</p>  <p>The first line corresponds to the part number (52010481B). The second line contains the date: the first two digits correspond to the day, the next two digits correspond to the month and the following two digits correspond to the year. The last four digits correspond to an internal serial code.</p> <p>E.g. code in figure <b>2805211314</b> → 28 May 2021</p>  <ul style="list-style-type: none"> <li>- If the date is prior to 01 August 2021 and you notice water infiltrations, replace the lights.</li> <li>- If the date is the same or after 01 August 2021, inform your Area Manager with a specific <b>Youtech</b>, explicitly indicating the date on the headlight, and attaching any photographic documentation.</li> </ul>



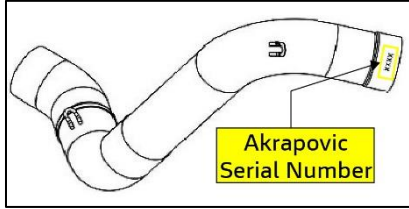



no.	Symptom	Subject	Photo	Notes and Indications - Corrective action
40	<p><b>ONLY</b> <b>Multistrada V4</b> <b>(all versions)</b></p> <p>Possible incorrect diameter of the silencer front or rear manifold in the Racing Exhaust Kit</p>	<p>Silencer front and rear manifold in the Racing Exhaust Kit</p>		<p>We have received some isolated reports about a possible non-conformity of the diameter of the silencer front or rear manifold inside the Racing Exhaust Kit Part no. <b>96481791CA</b>. This problem is limited to a very precise production lot identified by the Serial Number <b>6313441459</b> marked on the silencer manifolds as shown in the figure.</p>  <p>For this reason, we ask you to check the kits in your possession and verify their Serial Number. If the serial number is the same as the one shown above, we ask you to measure the diameter of the holes in the silencer manifolds with a gauge and check that they have a diameter of:</p> <ul style="list-style-type: none"> <li>- <b>50.0 mm</b> for silencer-side hole</li> <li>- <b>50.3 mm</b> for resonator-side hole</li> </ul>  <p>If the measured values are not correct, it will be necessary to order the conforming manifold using the following part numbers:</p> <ul style="list-style-type: none"> <li>- Silencer front manifold <b>Part no. 96413531A</b></li> <li>- Silencer rear manifold <b>Part no. 96413541A</b></li> </ul> <p>For warranty claims on components, we ask you to fill out a <b>Yutech</b> report and ask your Service Area Manager for guidance.</p>



## ← Tips & Tricks – Multistrada Family



no.	Symptom	Subject	Photo	Notes and Indications - Corrective action
41	<p><b>ONLY</b> <b>Multistrada V4</b> <b>(all versions)</b></p> <p>Possible oxidization of windscreen retaining screws</p>	Windscreen retaining screws		<p>We have received some reports about a possible oxidization of the windscreen retaining screws. Analysis has shown that this phenomenon could be caused by an unsuitable technological process that causes oxidation in the groove of the flat and in the holes made for decreasing part weight.</p> <p>Should you find such a phenomenon, please replace the 4 windscreen screws (<b>Part no. 7791C301AB</b>) and tighten them to <u>3 Nm ± 10%</u>.</p> 
42	<p><b>ONLY</b> <b>Multistrada V4 Pikes Peak</b></p> <p>Possible presence of error U1900-<i>Optional Configuration not carried out</i></p>	BBS Control Unit	-	<p>We have received some isolated cases, for which in pre-delivery, an error is present into BBS control unit of the bike: <b>U1900 - Optional Configuration not performed</b> in the ACTIVE state.</p> <p>To solve this, simply align the optional configuration on the bike as follows:</p> <ol style="list-style-type: none"> <li>1) Connect the DDS3.0 to the bike and select <b>Special Functions → Ducati Accessories Manager</b></li> <li>2) Select <b>Bike Configuration →</b> Enter the <b>SETTINGS</b> section and select the item "Activate accessory without order verification on DCS" and press the <b>START</b> button.</li> <li>3) Follow the instructions on DDS, press <b>Confirm</b> and enter the credentials used to access the DCS port and press the green tick at the bottom right.</li> <li>4) At this point, a message should appear "Accessories configuration different from that foreseen in the system - Electronic accessories configuration ready for writing" then press <b>OK</b>. Once the accessories list is displayed, press the green tick without enabling or disabling any accessories.</li> </ol> <p>The procedure is correctly implemented. Perform a Global Scan and delete the error.</p>



## ◀ Tips & Tricks – Multistrada Family





no.	Symptom	Subject	Photo	Notes and Indications - Corrective action														
43	<p><b>NEW</b></p> <p><u>ONLY</u> <u>Multistrada V2</u> <u>Multistrada V4 PP</u></p> <p>Possible interference between tank bag and front brake fluid reservoir/clutch fluid reservoir</p>	Tank bag		<p>We have received some reports that there may be a slight interference between the soft tank bag accessory (part no. 96780892A) (or pocket tank bag (part no. 96780262C)) and the front brake fluid reservoir or clutch fluid reservoir when turning left or right. This phenomenon could cause aesthetic defects to the tank bags.</p> <p>For this reason, the kit <i>"Brackets for mounting standard fluid reservoirs with tank bags"</i> was created to mount the brake and clutch fluid reservoirs in such a way as to eliminate possible interference for the models in question. The kits are differentiated by motorcycle model:</p> <ul style="list-style-type: none"> <li>• Part no. <b>97381991AA</b> for Multistrada V4 Pikes Peak with OEM brake/clutch fluid reservoir</li> <li>• Part no. <b>.97381201BA</b> for Multistrada V4 Pikes Peak with Ducati by Rizoma brake/clutch fluid reservoir</li> <li>• Part no. <b>97382001AA</b> for Multistrada V2/S/S Travel</li> </ul> <p>A dedicated note will be added to the accessories catalogue in the section dedicated to tank bags. The kit will be available from March, so we ask you to order it at the same time that the customer orders the single tank bag or the Urban accessories package (part no. 97980042C) that contains it.</p> <p>The kit comprises the following:</p> <table border="1" data-bbox="1263 826 1693 1058"> <thead> <tr> <th>Description</th> <th>Q.ty</th> </tr> </thead> <tbody> <tr> <td>Nut</td> <td>2</td> </tr> <tr> <td>Rubber bushing</td> <td>2</td> </tr> <tr> <td>SCREW M8X20</td> <td>2</td> </tr> <tr> <td>Rubber hose</td> <td>2</td> </tr> <tr> <td>Clutch fluid reservoir bracket</td> <td>1</td> </tr> <tr> <td>Brake fluid reservoir bracket</td> <td>1</td> </tr> </tbody> </table> 	Description	Q.ty	Nut	2	Rubber bushing	2	SCREW M8X20	2	Rubber hose	2	Clutch fluid reservoir bracket	1	Brake fluid reservoir bracket	1
Description	Q.ty																	
Nut	2																	
Rubber bushing	2																	
SCREW M8X20	2																	
Rubber hose	2																	
Clutch fluid reservoir bracket	1																	
Brake fluid reservoir bracket	1																	



## ← Tips & Tricks – Multistrada Family







no.	Symptom	Subject	Photo	Notes and Indications - Corrective action
44	<p><b>NEW</b></p> <p><u>ONLY</u> <u>MULTISTRADA V4</u> <u>(all versions)</u></p> <p>Possible color change of the Akrapovič silencer carbon endcap</p>	Akrapovič Silencer carbon endcap Type-approved and Racing		<p>We have received some reports of a possible color change of the Akrapovič racing Exhaust Silencer carbon endcap.</p> <ul style="list-style-type: none"><li>• Should the customer experience this phenomenon, please remove the carbon endcap and check for possible traces left by the passage of gas.</li><li>• Should the exhaust show traces of vents, please fill out a <b>Youtech</b> service request attaching photos highlighting the gas passages.</li></ul> <p>If the exhaust does NOT show any traces of gas passages, please fill out a <b>Youtech</b> service request and replace only the carbon endcap <b>Part no. 57315281A</b> and, at the same time, also the 4 aramid washers <b>Part no. 97610991A</b>.</p>
				 

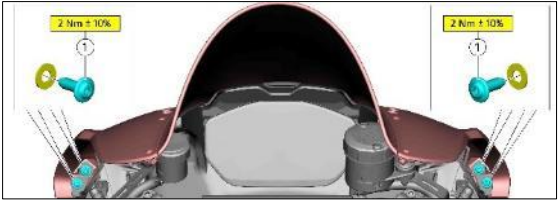

## ◀ Tips & Tricks – Panigale Family





no.	Symptom	Subject	Photo	Notes and Indications - Corrective action
1	<p><u>ONLY</u> <u>Panigale V2</u></p> <p>Precautions during PDI: installation of the side half-fairings</p>	Side half-fairings		<p>We received some isolated claims about the possible breakage of the top fastener retaining the LH side half-fairing to the headlight fairing.</p> <p>During PDI and whenever removing the side half-fairings, we remind you to pay utmost attention to the tightening of the <b>2 screws M5x0.8 (1)</b> retaining the upper LH and RH half-fairings to the headlight fairing; always comply with the specified tightening torque of <b>2 Nm ± 10%</b>.</p> 
2	<p><u>ONLY</u> <u>Panigale V4</u></p> <p>Precautions during PDI: installation of the balancing weights on the handlebar</p>	Balancing weights on handlebar		<p>We received some isolated claims about the possible triggering of a longitudinal crack on the handlebar, on balancing weight side. Our laboratory analyses found that said crack is due to an excessive tightening torque applied when installing the balancing weights.</p> <p>When installing balancing weights on the handlebar, please comply with the tightening torque specified for the M6x55 screw to <b>8 Nm ± 10%</b>, as indicated on the bulletin introducing the model and on the Workshop Manual.</p> 
3	<p><u>ONLY</u> <u>Panigale V4</u> <u>(all versions)</u> <u>Panigale V2</u></p> <p>Installation precautions Carbon number plate holder kit <b>part no. 97380921A</b></p>	Carbon number plate holder kit <b>part no.</b> <b>97380921A</b>		<p>We kindly inform you that <u>ONLY</u> when installing the carbon number plate holder kit part no. 97380921A to a Panigale V2 model, it is necessary to purchase wiring <b>part no. 5101H931A</b> to connect the number plate holder connector to motorcycle rear wiring harness connector.</p> <p>We also inform you that the new carbon number plate holder kit <b>part no. 97381161AA</b> is now available. It is specific for Panigale V2 and Streetfighter V4 and will include the above-mentioned wiring.</p> 





## ← Tips & Tricks – Panigale Family

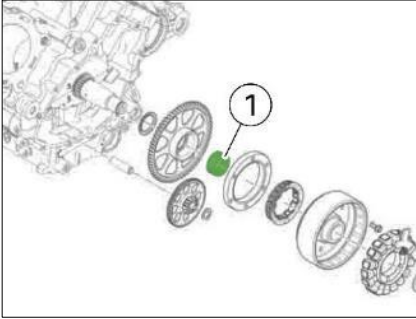



no.	Symptom	Subject	Photo	Notes and Indications - Corrective action
4	<p><u>ONLY Panigale V4</u></p> <p>Starting system update</p>	Starting system	-	<p>To ensure a better starting operation of the engine, we inform you that from engine serial number:</p> <ul style="list-style-type: none"> <li>- ZDM1100W4#007612# for EUR version</li> <li>- AGNK007652 for CAL version</li> </ul> <p>the <b>roller bearing (1)</b> has been introduced instead of the bushing.</p> <p>Please, note that the spare part catalogue has been updated.</p> 
5	<p><u>ONLY Panigale V2</u></p> <p>Validation of error C111A - Parking light [Short-circuit to positive or Open circuit].</p>	Number plate holder	-	<p>We are receiving some reports about the validation of error <b>C111A - Parking light [Short-circuit to positive or Open circuit]</b>.</p> <p><u>It was found from all Youtech requests that</u> the cause of the error validation was the installation of a NON GENUINE aftermarket number plate holder.</p> <p>We therefore ask you to <b><u>verify the presence of any NON GENUINE accessories before opening a Youtech request</u></b>; the electrical diagnosis on the Panigale V2 is particularly sensitive to variations in electrical absorption that may occur with the installation of non-genuine aftermarket number plate holders.</p>
6	<p><u>ONLY Panigale V4</u></p> <p>Possible surface defects on the lines connecting fluid reservoirs to front/rear brake master cylinder and clutch master cylinder</p>	Lines connecting fluid reservoirs to front/rear brake master cylinder and clutch master cylinder		<p>We have received some reports about a possible surface defect on the lines connecting fluid reservoirs to front/rear brake master cylinder and clutch master cylinder, respectively, due to a defective supply lot. This is a purely aesthetic defect that does not affect the correct operation of the front brake system and the clutch system.</p> <p>Proceed with the replacement of the line having the surface defect only in case of complaint by the Customer.</p> <p>We inform you that the first frame number with conforming lines is <b>ZMDMA04AALB011848</b>; the parts in stock have been reclaimed.</p>





## ← Tips & Tricks – Panigale Family



no.	Symptom	Subject	Photo	Notes and Indications - Corrective action
7	<p><u>ONLY</u> <b>Superleggera V4</b></p> <p>Use precautions vehicle canvas</p>	Vehicle canvas		<p>The first Superleggera V4 were delivered with the motorcycle canvas dedicated to motorcycle exclusive use in "racing" configuration (without rear-view mirrors and number plate holder assembly). Please, be informed that we have developed an additional motorcycle canvas, part no. 91910611AA, that can be used for motorcycle "road" configuration (with rear-view mirrors and number plate holder assembly installed); this canvas will be shipped FOC as standard to the Dealers where the first motorcycles were delivered and will be added to the kit coming with all the motorcycles manufactured starting from September 2020.</p> <p><u>Please, contact the Customers who have NOT received the motorcycle canvas for "road" configuration, to be able to schedule delivery.</u></p>
8	<p><u>ONLY</u> <b>Panigale V2</b></p> <p>Possible oil seepage from steering damper</p>	Sachs steering damper		<p>We have received some isolated reports of a possible oil seepage from Sachs steering damper due to an error in the production process of the supplier. The seepage does not affect the operation of the damper. The first compliant lot number marked on the component is "<b>Sachs 06-2020</b>" (06 = week = week of the year 2020). Please, be informed that compliant steering dampers have been installed starting from frame number <b>ZDMHAATWXLB001580</b> and that the spare parts in stock have been reclaimed (component Part no. is 36420101A).</p> <p>In the event of oil seepage from the steering damper, fill in a <b>Youtech</b> request and attach a picture of the component. Your Service Area Manager will inform you about the possible replacement of the component under warranty; in this case, use the operation <b>2-999-155 (2LU – 12 minutes)</b> present on the flat rate tables..</p>
9	<p><u>ONLY</u> <b>Panigale V4</b></p> <p>Possible flashing of low fuel light</p>	Low fuel light	-	<p>We have received some isolated claims about the flashing of low fuel light; this phenomenon is due to an electric problem of the thermistor resulting in the validation of <b>Error P0460 – Fuel level sensor [Short circuit to positive or Open circuit]</b>.</p> <p>Please, fill in a <b>Youtech</b> service request and then replace the component by ordering a new spare one Part no. 69928751A.</p>





no.	Symptom	Subject	Photo	Notes and Indications - Corrective action																						
10	<p><u>ONLY Panigale V4 (all versions)</u></p> <p>Possible failure to display gears on the instrument panel and validation of error P0916 - Gear sensor [Short-circuit to ground or Open Circuit]</p>	Gear sensor	<p>Hirschmann</p>  <p>Novotechnik</p> 	<p>We have received some reports about the failure to display the gear engaged on the instrument panel and the validation of the error <b>P0916 - Gear Sensor</b> [Short-circuit to ground or Open Circuit]. Based on the analyses carried out, this phenomenon is due to an overheating of the gear sensor.</p> <p>Two types of gear sensors have been installed on the Panigale V4 family, depending on the Model Year (suppliers: Hirschmann and Novotechnik), which differ both for the type of wiring and the magnet placed inside the selector drum. <u>The two gear sensors are NOT interchangeable at all.</u></p> <p>For the motorcycles featuring the Novotechnik gear sensor, a new stronger sensor is available as a spare part, which avoids the phenomenon described above. For the motorcycles featuring the Hirschmann gear sensor, refer to CR200 (SRV-TSB-20-012 bulletin). We therefore invite you to first check the type of sensor installed on the motorcycle and then, as a corrective action, follow the table below.</p> <table border="1"> <thead> <tr> <th>Models</th> <th>Model Year</th> <th>Gear Sensor</th> <th>Part no.</th> <th>Corrective action</th> </tr> </thead> <tbody> <tr> <td>Panigale V4 S/STD DMH production</td> <td>2018-2019</td> <td>Novotechnik</td> <td>55243522A</td> <td>Order the new gear sensor <b>part no. 55244421A</b> as spare part</td> </tr> <tr> <td>Panigale V4 R DMH production</td> <td>2019-2020</td> <td rowspan="2">Hirschmann</td> <td rowspan="2">55243941A</td> <td rowspan="2"><b>CR200 SRV-TSB-20-012</b></td> </tr> <tr> <td>Panigale V4 S/STD DMH and DMT production</td> <td>2020</td> </tr> <tr> <td>Panigale V4 S/STD DMH-DMT production</td> <td>2021</td> <td>Novotechnik</td> <td>55244421A</td> <td>NOT necessary</td> </tr> </tbody> </table>	Models	Model Year	Gear Sensor	Part no.	Corrective action	Panigale V4 S/STD DMH production	2018-2019	Novotechnik	55243522A	Order the new gear sensor <b>part no. 55244421A</b> as spare part	Panigale V4 R DMH production	2019-2020	Hirschmann	55243941A	<b>CR200 SRV-TSB-20-012</b>	Panigale V4 S/STD DMH and DMT production	2020	Panigale V4 S/STD DMH-DMT production	2021	Novotechnik	55244421A	NOT necessary
Models	Model Year	Gear Sensor	Part no.	Corrective action																						
Panigale V4 S/STD DMH production	2018-2019	Novotechnik	55243522A	Order the new gear sensor <b>part no. 55244421A</b> as spare part																						
Panigale V4 R DMH production	2019-2020	Hirschmann	55243941A	<b>CR200 SRV-TSB-20-012</b>																						
Panigale V4 S/STD DMH and DMT production	2020																									
Panigale V4 S/STD DMH-DMT production	2021	Novotechnik	55244421A	NOT necessary																						
11	<p><u>ONLY Panigale V2 Bayliss 1<sup>st</sup> Championship 20<sup>th</sup> Anniversary</u></p> <p>Pre-delivery precaution: check of the correct fork setting</p>	Pre-delivery precaution		<p>During the Pre-delivery operations and always, in any case, before delivering the vehicle to the end Customer, it is necessary to check the correct setting of the Öhlins forks featured on the "Panigale V2 Bayliss 1<sup>st</sup> Championship 20<sup>th</sup> Anniversary" as follows:</p> <ul style="list-style-type: none"> <li>• <b>PRELOAD</b> The preload must be set to +2 turns from fully open.</li> <li>• <b>COMPRESSION</b> The compression must be set to -25 clicks from fully closed.</li> <li>• <b>REBOUND</b> The rebound must be set to -19 clicks from fully closed.</li> </ul>																						



## ← Tips & Tricks – Panigale Family







no.	Symptom	Subject	Photo	Notes and Indications - Corrective action									
12	<p style="text-align: center;"><u>ONLY</u> <b>959 Panigale</b> <b>(all versions)</b></p> <p>Possible hardening of gear shift control with difficulty in shifting gears when hot</p>	Gear selector	-	<p>We have received some isolated reports about a possible hardening of the gear shift when hot with consequent difficult selection of gear ratios. Based on the analyses carried out, this phenomenon could be due to a hardening between the gearbox sensor magnet plastic support and the relevant seat inside the cover.</p> <p>You are kindly asked to carry out the following operations:</p> <ol style="list-style-type: none"> <li>1) Remove the <b>gear shift cover (1)</b> on motorcycle LH side</li> <li>2) Check for the presence of <b>shim (2)</b></li> <li>3) Mill the end face of the plastic cage for the selector magnet (3) shorter by 0.1 mm maximum and the outer curved edge where it enters the bore of the cover by 0.1 mm maximum, <u>or</u> mill the internal <b>surface (4)</b> of the cover highlighted in the figure and remove 0.1 mm maximum of material from the end and bore of the recess. Ensure the orientation of the magnet is not changed on the shift selector or the gear position will not be able to be determined by the sensor.</li> </ol> <div style="display: flex; justify-content: space-around;">    </div>									
13	<p style="text-align: center;"><u>ONLY</u> <b>Panigale V2</b> <b>(OEM, EUR and USA versions)</b></p> <p>New calibration for improved handling</p>	Handling improvement	-	<p>Please note that a new engine calibration is available for improved power delivery and hot start. The new calibration will not be proposed automatically but <u>should be installed only in case of Customer complaint</u>. Before and after the installation of the new calibration, it is necessary to make a LOG, from cold engine to hot engine, of the following parameters (select them from ECU self-diagnosis - parameters - new favorite list):</p> <p>HOR A/F self-learning, VER A/F self-learning, HOR lambda correction and VER lambda correction, engine speed [rpm], MAF target, engine temperature, atmospheric pressure, HOR MAP, VER MAP and Purge valve - PWM.</p> <p>Below are the passwords depending on the specific country version:</p> <table border="1" data-bbox="1050 1369 2197 1473"> <thead> <tr> <th>Calibrating</th> <th>OEM country versions</th> <th>Password</th> </tr> </thead> <tbody> <tr> <td>D2D1IU11GABAA1</td> <td>EUR + GBR + JAP + AUS + ROK2</td> <td>PANV2TESTEUR</td> </tr> <tr> <td>D2D1IU11GABBA1</td> <td>USA + Canada</td> <td>PANV2TESTUS</td> </tr> </tbody> </table>	Calibrating	OEM country versions	Password	D2D1IU11GABAA1	EUR + GBR + JAP + AUS + ROK2	PANV2TESTEUR	D2D1IU11GABBA1	USA + Canada	PANV2TESTUS
Calibrating	OEM country versions	Password											
D2D1IU11GABAA1	EUR + GBR + JAP + AUS + ROK2	PANV2TESTEUR											
D2D1IU11GABBA1	USA + Canada	PANV2TESTUS											



## ← Tips & Tricks – Panigale Family

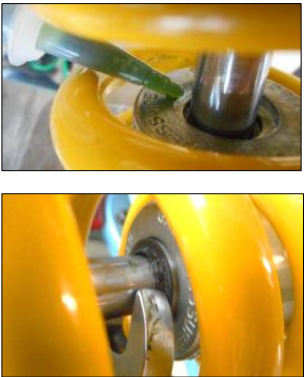



no.	Symptom	Subject	Photo	Notes and Indications - Corrective action
14	<p><u>ONLY Superleggera V4</u></p> <p>Possible mismatch between the silencer covers and the side half fairings if the complete Akrapovič racing titanium exhaust system is installed</p>	Coupling of the silencer cover and side half fairings		<p>We have received some isolated reports about an incorrect coupling between the silencer covers and the side half fairings in case the complete Akrapovič racing titanium exhaust system, supplied with the motorcycle, is installed. In fact, it is possible to find a misalignment between the mounting holes of the components.</p> <p>To improve this coupling, it is possible to slot-drill the 4 mounting holes of the silencer covers by using a column drill with a <u>6 mm drill bit</u> and setting a high rotation speed to prevent the fiber from flaking off.</p> 
15	<p><u>ONLY Panigale V2</u></p> <p>Possible popping out of the dust seal on the Sachs rear shock absorber buffer support plug</p>	Sachs rear shock absorber		<p>We have received some isolated reports about the possible popping out of the dust seal on the rear shock absorber buffer support plug.</p> <p><u>Do NOT replace the rear shock absorber.</u></p> <p>To avoid the phenomenon described above it is necessary to:</p> <ul style="list-style-type: none"> <li>- apply a few drops of <b>LOCTITE 638</b> on the plug, at the dust seal seat;</li> <li>- place the dust seal on the plug using an open-end wrench and hold it for a few seconds;</li> <li>- carefully clean any residues of LOCTITE 638 that may have fallen accidentally on the rod and on any other surface.</li> </ul> <p>Please note that the supplier, Sachs, has introduced LOCTITE 638 during the assembly stage from <u>week 29-2020</u> (this information can be found on the sticker on the shock absorber body).</p> 
16	Possible switching on of OBD warning light on instrument panel	Connector Engine ECU		<p>We have received reports concerning the switching on of the OBD warning light on the instrument panel and error validation:</p> <ul style="list-style-type: none"> <li>• P2100 ATT injection control unit, Front bank ETC electronic throttle motor power stage (Cyl 1-2) [Open circuit]</li> <li>• P210A ATT injection control unit, Rear bank ETC electronic throttle motor power stage (Cyl 3-4) [Open circuit]</li> </ul> <p>If your motorcycle is in these conditions, we ask you to check the status of the engine ECU connector as there may be moisture inside it and to fill out a <b>Youtech</b> service request attaching photos of the connector and specifying if the motorcycle has been washed with a pressure washer (with or without side fairings).</p>





## ← Tips & Tricks – Panigale Family

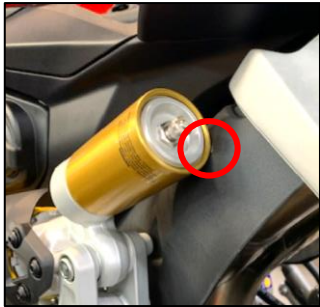
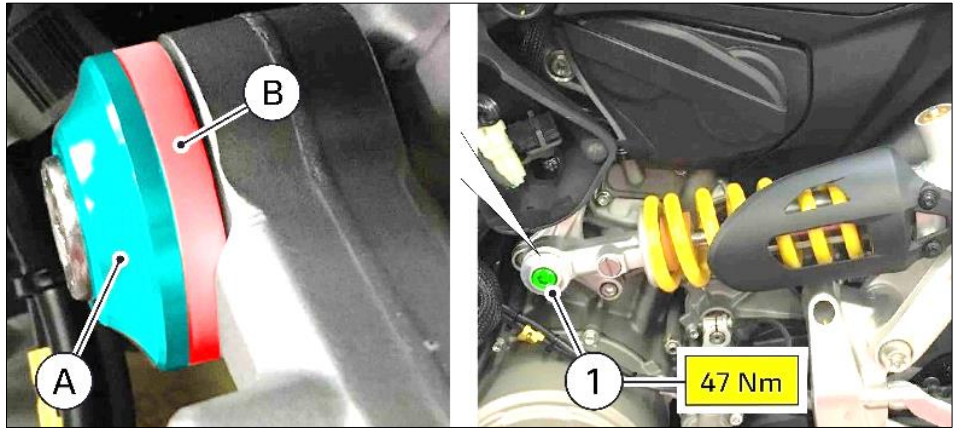

no.	Symptom	Subject	Photo	Notes and Indications - Corrective action
17	<p><u>ONLY</u> <u>Panigale V2</u></p> <p>Possible contact of Sachs rear shock absorber reservoir with vertical head manifold heat guard</p>	Sachs rear shock absorber reservoir		<p>We would like to inform you that starting from the frame number <b>ZDMHAATW2MB003762</b>, a spacer and a Teflon anti-rotation washer have been introduced at the front fixing screw of the shock absorber to prevent possible contact between the rear shock absorber reservoir and the vertical head manifold head guard. The contact results in a cosmetic defect only.</p> <p>In case of complaints from the Customer, it is possible to proceed with the installation of spacer <b>part no. 7111D981AA (A)</b> and washer <b>part no. 7131E352A (B)</b>, as shown in the figure.</p> <p>We remind you to always apply the <b>screw M10x45 (1)</b> with Shell GADUS S2 V220 AD 2 grease and to tighten the screw to the new torque of <b>47 Nm</b> (the previous tightening torque was 45 Nm).</p>  <p>The components are available as spare parts and can be ordered.</p>
18	<p><u>ONLY</u> <u>Panigale V4R</u></p> <p>Introduction of clutch housing with deep anodizing</p>	Housing clutch		<p>We have received some isolated reports of possible clutch slipping, due to clutch housing indentation, which does not allow the drive and driven plates to come back into contact with each other correctly. This phenomenon depends on the use of the motorcycle and the user, therefore for racing use we suggest replacing the plates approximately every 5000km,.</p> <p>We would like to inform you that the new clutch housing with deep anodizing <b>part no. 19810671C</b>, replacing the natural grey one, is available as a spare part; this treatment improves the reliability of the clutch housing reducing the damaging of the drive plates on its contact surface.</p>



## ← Tips & Tricks – Panigale Family





no.	Symptom	Subject	Photo	Notes and Indications - Corrective action
19	<p><u>ONLY</u> <u>Panigale V4 MY21</u></p> <p>Error "P0919 - Gear sensor plausibility" with MIL warning light turning on and/or failed display of the engaged gear on the instrument panel</p>	Error "P0919 - Gear sensor plausibility"	-	<p>If the error "P0919 - Gear sensor plausibility" occurs, <b>do NOT replace the gear sensor.</b></p> <p>It is necessary to check that the engine control unit software version is updated, then access the "Settings" section and activate the "<b>Reset of the final drive adaptive parameters</b>".</p> <div data-bbox="1724 284 2195 651" style="border: 1px solid black; background-color: #333; color: #fff; padding: 5px;"> <ul style="list-style-type: none"> <li>CCP Enabling/Disabling</li> <li>DQS adaptives reset</li> <li>Idle control adaptives reset</li> <li>Idle speed engine operation mode</li> <li>Knock sensor adaptives reset</li> <li>Reset gears</li> <li style="border: 2px solid red;">Reset of the transmission adaptive values</li> </ul> </div>
20	<p><u>ONLY</u> <u>Panigale V4 and V4 S.</u></p> <p>Contact between tire and front mudguard</p>	Front mudguard	-	<p>We have received some isolated reports on the possible contact between the front tire and the relevant mudguard. This contact can cause an aesthetic damage to mudguard front side.</p> <p>Please, fill in a <b>Youtech</b> service request and then replace the component under warranty by ordering a new spare one as follows:</p> <ul style="list-style-type: none"> <li>• Panigale V4: Part no. 56416741AA</li> <li>• Panigale V4 S: Part no. 56416741AK</li> </ul> <div data-bbox="1724 673 2190 1061" style="border: 1px solid black; padding: 5px;"> </div>
21	<p><u>SUPERLEGGERA 1299</u> <u>ONLY</u></p> <p>Scheduled maintenance Checklist update</p>	Final drive chain	-	<p>We would like to inform you that the Scheduled Maintenance Checklist, attached to the model introduction bulletin SRV-SRB-17-012, has been updated modifying the intervention to be carried out on the final drive chain and on the various parts of the drive system.</p> <p>Given the presence of the <u>Ergal rear sprocket</u> and the <u>ORAW2 520 Regina chain</u>, the interventions have been modified as follows:</p> <ul style="list-style-type: none"> <li>• Check final drive chain, chain sliding shoes, front and rear sprockets wear. Check final drive chain tension, lubrication and stretch. Measured stretch value:_____ (cm)</li> <li>• Replace chain, chain sliding shoes, rear sprocket, front sprocket and swingarm protection plate</li> </ul> <p><b>The latter operation must be performed every 5,000km/3,000mi.</b></p>



## ← Tips & Tricks – Panigale Family









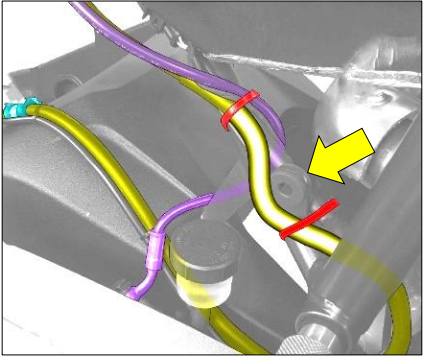
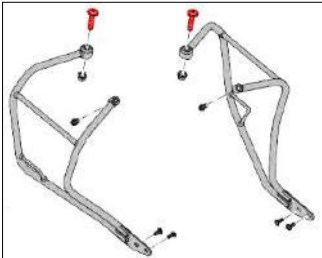

no.	Symptom	Subject	Photo	Notes and Indications - Corrective action	
22	<p><u>Panigale MY21 - MY22</u> <b>ONLY</b></p> <p>Rear-view mirror upgrade</p>	Rear-view mirrors		<p>We received some isolated claims about the possible breakage of the rear-view mirror arm due to minor impacts.</p> <p>We would like to inform you that to avoid the phenomenon described above, new, stronger rear-view mirrors have been introduced and can be ordered using the following part numbers:</p> <ul style="list-style-type: none"><li>• LH rear-view mirror: <b>Part no. 523S0645A</b></li><li>• RH rear-view mirror: <b>Part no. 523S0655A</b></li></ul> <p>In the event of rear-view mirror arm breakage due to minor impacts, we ask you to send a Youtech service request and then proceed with replacement of the component under warranty unless otherwise advised by your reference Service Area Manager.</p>	
23	<p><u>ONLY</u> <u><b>SUPERLEGGERA V4</b></u></p> <p>Information for the assembly of the Akrapovič DP2 exhaust</p>	Akrapovič titanium racing full exhaust		<p>We hereby would like to inform you that the instructions of the workshop manual for the assembly of the Akrapovič Titanium Exhaust Kit for the involved model are currently being updated.</p> <p>To install the exhaust, open a <b>Youtech</b> service request for support during assembly and all the necessary information.</p>	



# ← Tips & Tricks – Scrambler Family





no.	Symptom	Subject	Photo	Notes and Indications - Corrective action				
1	<p><u>ONLY Scrambler 800 (all model versions and MY, excluding Desert Sled model version)</u></p> <p>Precautions when routing the rear brake caliper hose</p>	Rear brake hose	-	<p>We have found that sometimes, during maintenance operations, the rear brake caliper hose is not correctly positioned along the frame due to incorrect installation by the technician during service.</p> <p>Make sure that the rear brake caliper hose (yellow), passes outside the left side cover mounting bracket with respect to the motorcycle centerline and is fixed with the two self-locking ties (red) as shown in the figure.</p> <p>The operation of inspection and possible repositioning is very simple and involves the disassembly of the left side cover only.</p> 				
2	<p><u>ONLY Scrambler 1100 (all model versions)</u></p> <p>Assembly precautions Bracket accessory kit for side panniers <b>Part no. 96781361A</b></p>	Bracket accessory kit for side panniers <b>Part no. 96781361A</b>		<p>Due to a supply error, you may find brackets for soft side bags inside the accessory kit and the presence of a pair of non-compliant M10X45 screws as they are partially threaded instead of completely threaded, as shown in the figure.</p> <p>We ask you to always check that all the kit components are present and correct before installing them and, if the screws are not correct, order the 2 screws M10X45 <b>part no. 77242713C</b> (the parts in stock have been reclaimed).</p> <table border="1" data-bbox="1173 895 2063 1098"> <thead> <tr> <th data-bbox="1173 895 1617 935">NON-COMPLIANT Screw M10X45</th> <th data-bbox="1617 895 2063 935">COMPLIANT Screw M10X45</th> </tr> </thead> <tbody> <tr> <td data-bbox="1173 935 1617 1098"></td> <td data-bbox="1617 935 2063 1098"></td> </tr> </tbody> </table> <p>We would also like to inform you that there is a label on the kit box, and at the top right it bears numbers indicating the progressive number and the year of manufacture. The kits that may include the 2 non-compliant M10X45 screws and therefore need to be inspected before proceeding with the installation are numbers "19053" and "19064".</p> 	NON-COMPLIANT Screw M10X45	COMPLIANT Screw M10X45		
NON-COMPLIANT Screw M10X45	COMPLIANT Screw M10X45							
								





## ← Tips & Tricks – Scrambler Family

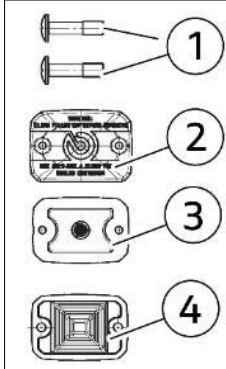
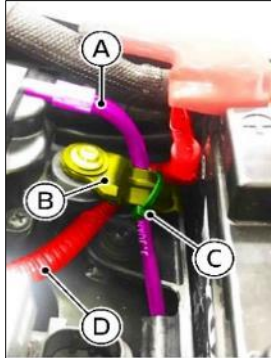



no.	Symptom	Subject	Photo	Notes and Indications - Corrective action
3	<p><u>ONLY</u> <b>Scrambler Desert Sled</b> <b>Scrambler ICON</b> <b>Scrambler Full Throttle</b> <b>Model Year 2019 - 2020</b></p> <p>Possible oozing out of brake fluid from reservoir cover</p>	Front brake fluid reservoir		<p>We inform you that in case of complaints from Customers about a possible oozing out of front brake fluid from the relevant reservoir. This condition does not affect the operation of the brake system. It is possible to order the following kit part no. 89340331A as spare part to avoid the symptom in question.</p> <p>The kit part no. 89340331A includes:</p> <ul style="list-style-type: none"> <li>• 2 screws (1)</li> <li>• Cover (2)</li> <li>• Membrane (3)</li> <li>• Baffle (3)</li> </ul> 
4	<p><u>ONLY</u> <b>Scrambler 1100</b> <b>Model Year 2020</b> <b>(all model versions)</b></p> <p>Precautions during PDI: installation of the battery on the vehicle</p>	Battery assembly	-	<p>During the installation of the battery on the vehicle and, in any case, when the motorcycle first comes to the workshop for a service, we ask you to always check the correct positioning of the <b>exhaust butterfly valve cable (A)</b> under the <b>retainer (B)</b> and the presence of the <b>self-locking tie (C)</b>.</p> <p>Make sure the <b>motorcycle positive cable (D)</b> is positioned under the <b>exhaust butterfly valve cable (A)</b>.</p> 
5	<p><u>ONLY</u> <b>Scrambler 1100 PRO</b> <b>(all versions)</b></p> <p>Irregular operation at idle speed and engine power loss</p>	Vertical cylinder LH spark plug cable	-	<p>As a result of continuous quality tests on the product, we have found a possible irregular operation at idle speed and engine power loss. This phenomenon is due to a settling of the vertical cylinder LH spark plug cable on the coil caused by the contact with the fitting of the oil return pipe from cooler (visible on motorcycle RH side). The MIL light does not come on.</p> <p>We ask you to always check the conditions of vertical cylinder LH spark plug cable and to apply the protective sheath Part no. 4601C581A (cut in half and secured in place with two small self-locking ties) on the fitting of the oil return pipe from cooler to avoid the above-described phenomenon.</p> 





## ◀ Tips & Tricks – Scrambler Family



no.	Symptom	Subject	Photo	Notes and Indications - Corrective action
6	<p><u>Scrambler 800 ONLY</u></p> <p>Possible water seepage inside front and rear turn indicators</p>	Turn indicators		<p>We have received some isolated reports about a possible water seepage inside front and/or rear turn indicators Part no. 53010412B fitted on some versions of the Scrambler 800.</p> <p>The qualitative analyses of the components returned from the network showed that this phenomenon is due to a possible impact against the turn indicator resulting in the detachment of the rubber seal present inside the support, as shown in the figure.</p> <p>Should the phenomenon mentioned above be present, you are kindly invited to check the correct positioning of the seal as we <u>will NOT accept any replacement requests under warranty.</u></p> <div style="display: flex; justify-content: space-around;"> <div data-bbox="1883 284 2195 459">  </div> <div data-bbox="1883 480 2195 655">  </div> </div>
7	<p><u>ONLY Scrambler 800 MY21</u></p> <p>Possible appearance of errors U0323, P0500, P2158</p>	Anti-theft system kit	-	<p>After the installation of the anti-theft system kit supplied in the accessory catalogue, we have received some isolated reports concerning the simultaneous or single appearance of the following errors, in ACTIVE, IN VALIDATION or STORED status:</p> <ul style="list-style-type: none"> <li>• U0323 – Instrument panel control unit compatibility error</li> <li>• P0500 – Rear speed sensor</li> <li>• P2158 – Front speed sensor</li> </ul> <p>in the engine ECU. Error U0323 causes the <b>MIL</b> warning light to light up on the instrument panel, without affecting the correct operation of the vehicle (no vehicle stop).</p> <p><b>It is neither necessary to replace any speed sensors nor the engine control unit.</b></p> <p>Therefore, if these errors are present and the anti-theft system kit is installed, we kindly ask you to fill out a <b>Youtech</b> service request indicating:</p> <ul style="list-style-type: none"> <li>• Part Number of the installed anti-theft system kit,</li> <li>• Detailed conditions in which the MIL light has been noticed by the customer, i.e.: if the vehicle was turned off with the anti-theft system ON or OFF; when the anti-theft system was activated; how many hours have elapsed since the last key-off.</li> </ul>



## ◀ Tips & Tricks – Scrambler Family





no.	Symptom	Subject	Photo	Notes and Indications - Corrective action
8	<p><u>Scrambler 800 MY21-22</u>            (all country versions -            USA, Canada, Thailand            and China excluded)  <u>ONLY</u></p> <p>Irregular idling rpm after            engine start</p>	Idling check management	-	<p>We have received some isolated reports of a temporary (30sec - 40sec) idling rpm irregularity after a cold engine start. The phenomenon is being analyzed so, should you receive this complaint, we ask you to open a <b>Youtech</b> service request, enclosing a recording of the engine parameters listed below, starting from engine condition at room temperature up to 5 minutes after starting:</p> <ul style="list-style-type: none"> <li>• Engine rpm</li> <li>• Engine Temperature</li> <li>• Air Temperature</li> <li>• Vertical Cylinder MAP value (mBar)</li> <li>• Horizontal Cylinder MAP value (mBar)</li> <li>• Vertical Cylinder Injection Timing value</li> <li>• Horizontal Cylinder Injection Timing value</li> <li>• Vertical Cylinder Injection Time Correction by Lambda Control</li> <li>• Horizontal Cylinder Injection Time Correction by Lambda Control</li> <li>• A/F Self Learning parameters on Vertical Cylinder (Offset)</li> <li>• A/F Self Learning parameters on Horizontal Cylinder (Offset)</li> </ul> <p>Please enclose the complete folder, with the date and time of the recording in its name, in compressed .zip or .rar format. The recording file can be found at the following location:</p> <ul style="list-style-type: none"> <li>- DDS 2.0 → C:\ProgramData\Ducati\DDS20\vehicle\data\autodia\sessions</li> <li>- DDS 3.0 → C:\ProgramData\Ducati\DDS30\vehicle\data\autodia\sessions</li> </ul> <p>If, during the recording analysis, suction pressure values lower than 465 mbar ± 10 mbar at 100 °C engine temperature are detected, we ask you to check the value of the opening and closing valve clearance values and report them in the Youtech request. Below are the nominal opening and closing values for your convenience:</p> <ul style="list-style-type: none"> <li>- Opening nominal values: 0.10 mm - 0.15 mm</li> <li>- Closing nominal values: 0.02 mm - 0.05 mm</li> </ul> <p>Should values outside the tolerance range be detected, we ask you to adjust the valve clearance to the minimum value foreseen by the tolerance range, i.e:</p> <ul style="list-style-type: none"> <li>- 0.10 mm for opening valve clearance (on intake and exhaust)</li> <li>- 0.02 mm for closing valve clearance (on intake and exhaust)</li> </ul>



## ◀ Tips & Tricks – Streetfighter V4 Family

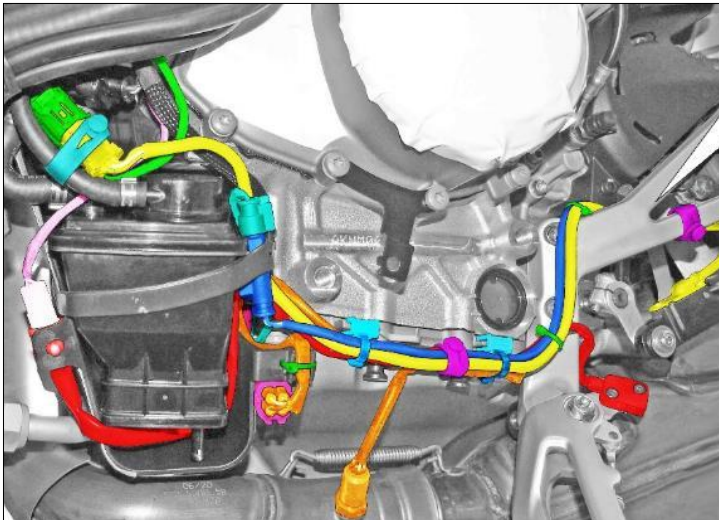
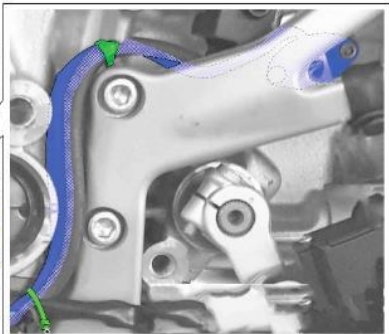
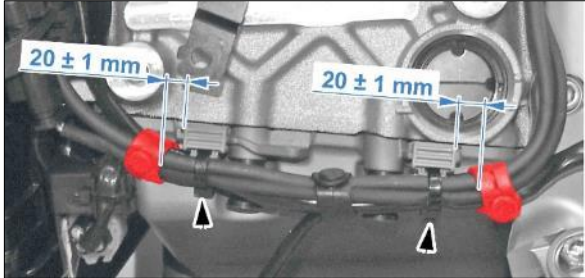



no.	Symptom	Subject	Photo	Notes and Indications - Corrective action
1	Updated layout of motorcycle wiring	Wiring	-	<p>We would like to inform you that the layout of the side stand cable - gear sensor cable - Ducati Quick Shift cable - lambda sensor cable and of the gear sensor connector and cable at the lower crankcase, on the left side of the motorcycle (as shown in the figure) has been updated starting from frame number ZDMFA00AALB003932.</p>   <p>Before installing the wiring cover, apply two L=39 mm button ties respecting the dimensions shown in the figure:</p>   <p>We ask you to respect the new layout of the cables and the gear sensor connector in case of servicing of the mentioned parts.</p>



## ◀ Tips & Tricks – Streetfighter V4 Family



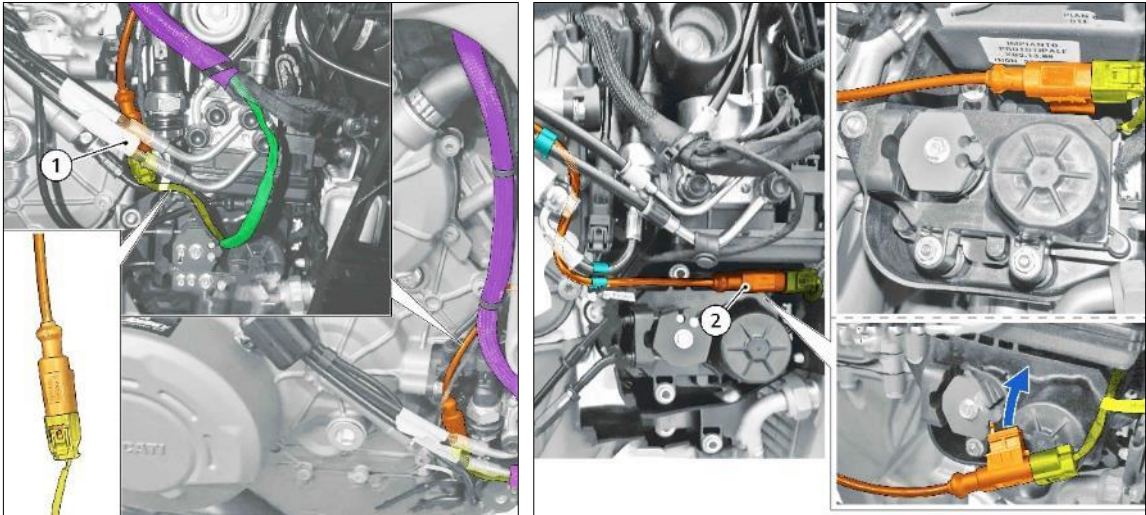

no.	Symptom	Subject	Photo	Notes and Indications - Corrective action
2	Interference between gearchange lever and side stand	Gearchange lever/ side stand		<p>As a result of continuous quality tests on the product, we have found a slight interference between the gear shift control lever and the side stand. This contact is very slight, does not give rise to functional or aesthetic problems and can only occur in the overtravel phase, when engaging the first gear.</p> <p>We inform you that no corrective actions are available so far.</p>
3	Assembly precautions for the complete titanium exhaust system part no. 96481652AA	Complete titanium exhaust system part no. 96481652AA		<p>We have received some isolated reports of vehicle speed limitation at values below 50 km/h due to the excessive traction control (DTC) intervention resulting from the installation of the complete titanium exhaust system part no. 96481652AA. The performed analyses have shown that the front and rear speed sensor connections were reversed.</p> <p><u>In case of interventions on the front (1) and rear (2) speed sensor connectors, please take the utmost care to their assembly, as shown in the figure, making sure not to reverse the connections</u></p> 



## ◀ Tips & Tricks – Streetfighter V4 Family







no.	Symptom	Subject	Photo	Notes and Indications - Corrective action
4	Assembly precautions Anti-theft system kit part no. 96680811A	Anti-theft system kit Part no. 96680811A		Please, be reminded that if anti-theft system kit Part no. 96680811A is installed for model Streetfighter V4, the anti-theft system/DMS support set (additional wiring with anti-theft system fastening support bracket) Part no. 96680941BA must be purchased at the same time, as specified on the spare part catalogue "compatibility" section.
5	Possible flashing of low fuel light	Low fuel light	-	<p>We have received some isolated claims about the flashing of low fuel light; this phenomenon is due to an electric problem of the thermistor resulting in the validation of <b>Error P0460 - Fuel level sensor [Short circuit to positive or Open circuit]</b>.</p> <p>Please, fill in a <b>Youtech</b> service request and then replace the component by ordering a new spare one Part no.69928751A.</p>
6	Possible breakage of the RH heat guard the rear bank	RH heat guard the rear bank Part no.4601G351B		<p>We have received some isolated reports of a crack in the rear bank RH heat guard at the retaining screw, as shown in the figure.</p> <p>We would like to inform you that the spare part warehouse has been inspected and only includes the new conforming components; the part number has not changed so, in case of breakage, it is possible to replace it under warranty with a new part no. 4601G351B which avoids the above phenomenon.</p>





## ◀ Tips & Tricks – Streetfighter V4 Family

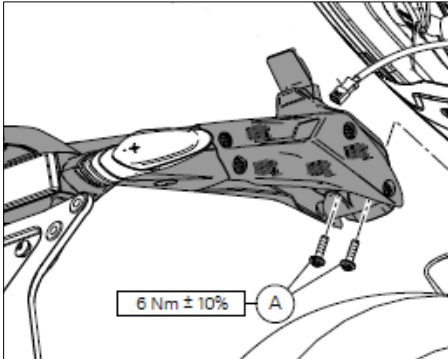

no.	Symptom	Subject	Photo	Notes and Indications - Corrective action
7	Update of pre-delivery operations: Battery assembly	Battery Assembly		<p>We have received isolated reports of possible interference between the battery negative cable and the battery cover (in particular, the pin fixing the mesh to the cover). To avoid the contact described above, we have updated the battery fitting procedure and in particular that of the ABS negative cable; it is necessary to connect the <b>ABS negative cable (A)</b> orienting it towards the ignition switch as shown in the figure:</p> <div style="display: flex; justify-content: space-around;">   </div> <p>We ask you to follow the new battery fitting procedure during pre-delivery operations and in any case to always check that the battery is fitted correctly the first time the motorcycle is brought to the workshop. <u>This new battery mounting procedure cancels and replaces the information contained in the model introduction bulletin SRV-SRB-20-002.</u></p>
8	Precautions for the assembly of Ducati Performance carbon number plate holder kit Part no. 97381161CA	Ducati Performance carbon number plate holder kit Part no. 97381161CA		<p>When assembling the Ducati Performance carbon number plate holder unit part no. 97381161CA, we remind you to always apply <b>LOCTITE 243</b> on the threads of the <b>2 screws (A)</b> for fixing the unit to the rear subframe and tighten them to the specified torque of <b>6 Nm ± 10%</b> as indicated in the relevant instructions.</p> 



## ← Tips & Tricks – Streetfighter V4 Family



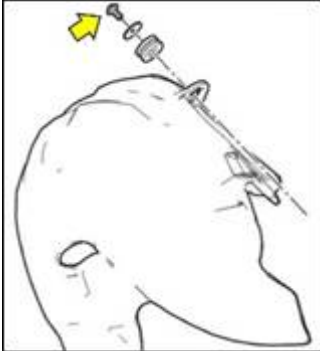

no.	Symptom	Subject	Photo	Notes and Indications - Corrective action
9	<p><u>ONLY</u> <u>Streetfighter V4 MY21</u> <u>(all versions)</u></p> <p>New brake master cylinder and clutch master cylinder</p>	Brake master cylinder and Clutch master cylinder	-	<p>All Streetfighter V4 Model Year 2021 versions are equipped with the new "self-purging" front brake master cylinder and clutch master cylinder (the previous Model Year featured the "traditional" front brake master cylinder and clutch master cylinder).</p> <p>At first sight, they may appear visibly similar to those installed on the Multistrada V4 model (presence of the hole for hand guards fitting) but they are not the same and cannot be interchanged, as the distance between centers of the lever as well as the shape of the lever itself are different.</p> 
10	Possible loosening of the screw retaining the heat guard	Screw 77244163B retaining the rear bank exhaust manifold heat guard	-	<p>We have received a few reports about a possible loosening of the screw retaining the rear bank exhaust manifold heat guard.</p> <p>The issue is being investigated, therefore, we kindly ask you to check the correct tightening of the above-mentioned screw (part no. 77244163B) when coming to the workshop (the prescribed tightening torque is <b>5 Nm ± 10%</b>).</p> 



## ◀ Tips & Tricks – SuperSport Family

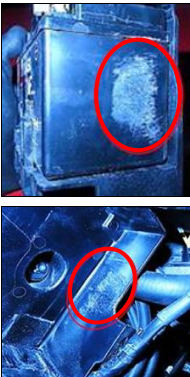
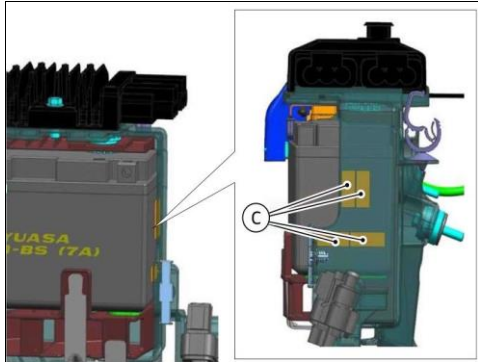

no.	Symptom	Subject	Photo	Notes and Indications - Corrective action
1	<u>ONLY SuperSport 950 MY2021</u> Contact between the battery and its support	Battery		<p>The ongoing tests on the product have revealed the possibility of contact between the battery and its support, which causes marks on both surfaces due to vibration. These marks do NOT affect the correct operation of the electric system and therefore of the vehicle.</p> <p>In order to prevent such marks, <b>4 adhesive pads (C)</b> in rubber 9X23X1.4 part no. 86612791A have been introduced in the production line to be applied inside the battery support.</p> 
2	<u>ONLY SuperSport 950 MY2021</u> Possible cracks on windscreen Plexiglas close to mounting holes	Windscreen		<p>We have received some isolated reports about the possible cracks on the windscreen Plexiglas during tightening and/or while riding due to the stresses of the ground roughness.</p> <p>We would like to inform you that a new windscreen able to avoid the phenomenon described above has been introduced (there has been no part no. change and all components in stock have been restored).</p> <p>Finally, please be reminded to always respect the tightening torque of <b>5 Nm ± 10%</b> indicated for windscreen retaining screws.</p>
3	<u>SuperSport 950 ONLY</u> Engine warning light on: ECU Error P0314	Intake Manifold		<p>We have received some reports about the engine warning light coming on due to ECU error P0314. The error refers to high Misfire with risk of damage to the catalytic converter. Please note that the error may be caused by an incorrect coupling between the intake manifolds and the air-box.</p> <p>We therefore ask you to check the following:</p> <ul style="list-style-type: none"> <li>- throttle bodies are correctly inserted inside rubber intake manifolds, along the whole perimeter;</li> <li>- the rubber profile of the intake manifolds is not deformed;</li> <li>- the 2 fastening ties are correctly positioned in the seat on the intake manifolds.</li> </ul>