

PORSCHE Front Camera (Dashcam)

Information: **Retrofitting**



Information



Figure 1

Model Year: **As of 2017**

Note: The Porsche front camera (dashcam ⇒ *Figure 1*) is affixed to the **LEFT** of the interior mirror (viewed in direction of travel) on the windshield and is connected to the vehicle electrical system.

It is ideal for making video recordings of driving situations and while parking. It can be configured and operated using a related app on your smartphone.

Recorded videos are stored on the supplied SD card and previous recordings are overwritten.

If the dashcam detects a shake/vibration or if the radar sensor is triggered, the recorded video is stored separately and not overwritten. Recordings can be downloaded directly from the SD card or via the app.



Information

Important information for customers/customer service advisors:

- Ask customers to download and install the "Porsche Dashcam App" from the App Store (Apple or Google Play) on their device (smartphone/tablet) in advance.

For vehicle handover:

- Together with the customer, check whether a firmware update via "Porsche Dashcam App" is necessary. Perform the firmware update together if necessary.
- Together with the customer, choose the "Region/State/Country" by selecting the relevant flag and format the SD card.

Further information for customers:

- The customer is responsible for choosing the right "Region/State/Country"!
- After crossing a national border: Update the "Region/State/Country" (see also conditions of use for this topic)!

Parts Info:

9Y0.044.930

⇒ PORSCHE front camera (dashcam), set

Parts List:



Figure 2

----	1 x	3M privacy film (front & rear camera) ⇒ <i>Figure 2-1-</i>
----	1 x	Front camera ⇒ <i>Figure 2-2-</i>
----	1 x	Micro SD memory card (32 GB, plugged into front camera) ⇒ <i>Figure 2-3-</i>
----	1 x	Front camera retainer plate assembly with wire harness ⇒ <i>Figure 2-4-</i>
----	1 x	Wire harness assembly with connector (3-pin, wire approx. 4 m long) ⇒ <i>Figure 2-5-</i>
----	3 x	Protective foam (Ø approx. 29 x 74) ⇒ <i>Figure 2-6-</i>
----	7 x	Tie-wrap, 145 x 3.6 x 1.1 ⇒ <i>Figure 2-7-</i>
N .907.326.01	4 x	Socket contact, 4.8 x Ø 1.0 mm ² ⇒ <i>Figure 2-8-</i>
N .907.327.01	2 x	Socket contact, 4.8 x Ø 2.5 mm ² (standard power timer) ⇒ <i>Figure 2-9-</i>
N .906.844.01	3 x	Socket contact, 2.8 x Ø 1.0 mm ² (junior power timer) ⇒ <i>Figure 2-10-</i>
999.650.136.22	4 x	Socket contact, 5.0 x Ø 1.0 mm ² ⇒ <i>Figure 2-11-</i>
N .017.506.5	2 x	Cable ring eyelet, A6 ⇒ <i>Figure 2-12-</i>
992.971.859.B	2 x	Cable ring eyelet, M8 ⇒ <i>Figure 2-13-</i>
N .102.615.01	2 x	Blade-type fuse, 5 amp (mini) ⇒ <i>Figure 2-14-</i>
N .017.131.16	2 x	Blade-type fuse, 5 amp ⇒ <i>Figure 2-15-</i>
----	1 x	PORSCHE dashcam operating instructions ⇒ <i>Figure 2-16-</i>

Repair Kits: **ONLY** order when replacing the windshield/rear window:

9Y0.044.931	1 x	"Adhesive pad" repair kit, includes:
----	1 x	Adhesive pad for front camera retainer plate (grey) on backing sheet
----	1 x	Adhesive pad for rear camera (grey)
----	1 x	3M privacy film (front & rear camera) ⇒ <i>Figure 2-1-</i>

ONLY order if front camera "wiring harness" is damaged:

9Y0.044.931	1 x	"Adhesive pad" repair kit
9Y0.044.932	1 x	Wiring harness repair kit, includes:
----	1 x	Front camera retainer plate assembly with wire harness (WITHOUT adhesive pads, similar to ⇒ <i>Figure 2-4-</i>)
----	1 x	Wire harness assembly with connector (3-pin, wire approx. 4 m long) ⇒ <i>Figure 2-5-</i>
----	3 x	Protective foam (Ø approx. 29 x 74) ⇒ <i>Figure 2-6-</i>
----	7 x	Tie-wrap, 145 x 3.6 x 1.1 ⇒ <i>Figure 2-7-</i>
----	1 x	Bag with socket contacts, cable ring eyelets and fuses ⇒ <i>Figure 2-8-15-</i>

- Technical Details:
- Video recording in Quad High Definition (QHD)
 - Lens with polarization filter to reduce reflections and improve colors and contrasts
 - Audio recording (can be deactivated)
 - Global positioning system (GPS) sensor
 - Vibration sensor
 - Radar sensor for video recording when an object is approaching the vehicle
 - Bracket for the windshield for fixed mounting on the vehicle

Revision: This bulletin replaces bulletin Group 9 8/21, dated September 28, 2021.

Materials:	— — —	1 x	Auxiliary line (Tekalan or Teflon hose) approx. 1,500 mm/ 59 in long
	— — —	1 x	Wrapping/insulating tape (commercially available)
	— — —	1 x	Cleaning cloth (commercially available)
	— — —	1 x	Isopropanol (commercially available)

Tools: **9900 - PIWIS Tester 3**

Tablet, smartphone or PC with Internet access

Round file \varnothing at least 7 mm/ 0.28 in, Stanley knife, scraper

Marking pencil/chalk

Flashlight

Plastic squeegee

Installing: 1 Preparatory work

1.1 Clean inside and outside of the windshield.

1.2 Connect battery charger. \Rightarrow *Workshop Manual '2X00IN Battery trickle charging'*

1.3 Expose front roof/rear-view mirror area (interior \Rightarrow *Figure 3*)

- 1 – Roof console (front)
- 2 – Cover on antenna
- 3 – Sun visor (left)
- 4 – A-pillar trim panel (left)

1.3.1 Remove (front) roof console and cover on antenna. \Rightarrow *Workshop Manual '708319 Removing and installing front roof console'*

1.3.2 Remove sun visor (at the left \Rightarrow *Figure 3-3-*). \Rightarrow *Workshop Manual '682319 Removing and installing sun visor'*

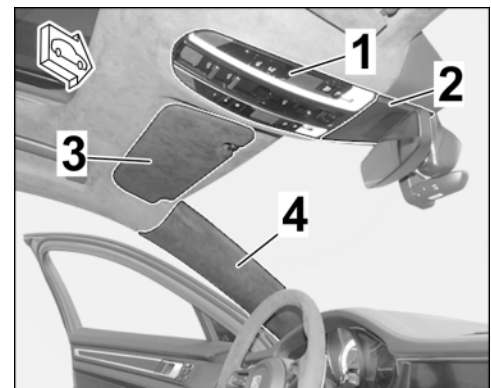

Figure 3

1.4 Expose A-pillar area (at the left ⇒ *Figure 4*)

- 1 – Cover for dashboard (left)
- 2 – A-pillar trim panel (left)
- 3 – Front side-section trim panel (left)
- 4 – Front inner door sill trim

1.4.1 Remove dashboard trim panel (at the left). ⇒ *Workshop Manual '701619 Removing and installing dashboard trim panel'*

1.4.2 Remove front side-section trim panel (at the left). ⇒ *Workshop Manual '702419 Removing and installing front side-section trim panel'*

1.4.3 Remove A-pillar trim panel (at the left). ⇒ *Workshop Manual '705719 Removing and installing A-pillar trim panel'*

1.4.4 Remove front inner door sill trim (at the left). ⇒ *Workshop Manual '680519 Removing and installing (front) inner door sill trim'*

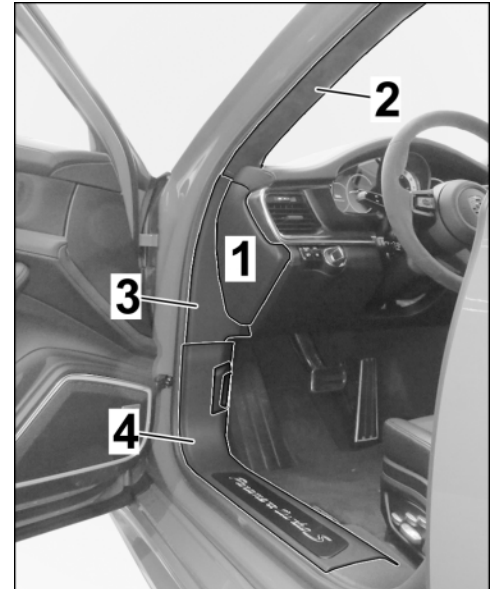

Figure 4

1.5 Loosen front headliner by removing the screw (at the left/right) in the roof console area. ⇒ *Workshop Manual '708419 Removing and installing headliner'*

1.6 Make groove for wire harness for retainer plate in cover on antenna (⇒ *Figure 5*).

- 1 – Cover on antenna
- 2 – Locking lug
- 3 – Groove
- D – Diameter of groove = 7 mm/ 0.28 in

1.6.1 On inside of cover on antenna: Mark dimension X for groove (for wire harness for retainer plate) at the side of the left locking lug.

Dimension D = diameter of groove:

Diameter 7 mm

1.6.2 Carefully make a groove for wire harness for retainer plate at the marking using a round file or similar tool.

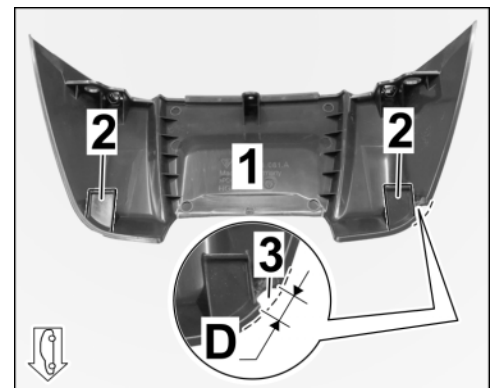

Figure 5

2 Install PORSCHE front camera (dashcam) in the vehicle

Overview of installation position ⇒ *Figure 6*

- 1 – Interior mirror
- 2 – Installation position of PORSCHE front camera (dashcam)
- 3 – Electric wire harness
- 4 – Ground pin 11
- 5 – Fuse carrier (under left front seat)

2.1 Position front camera (dashcam) to the **LEFT** of the interior mirror on the windshield

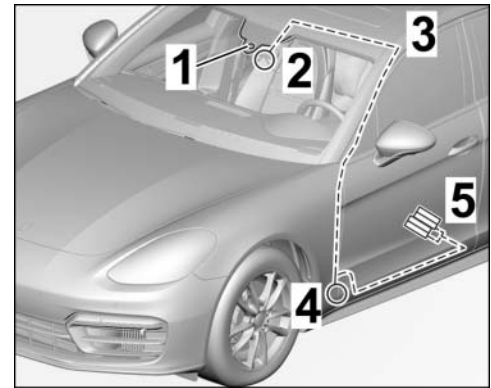

Figure 6

2.1.1 Install retainer plate with wire harness on the base of the front camera until the locking mechanism engages (⇒ *Figure 7*).

- 1 – Retainer plate with wire harness
- 2 – Front camera base

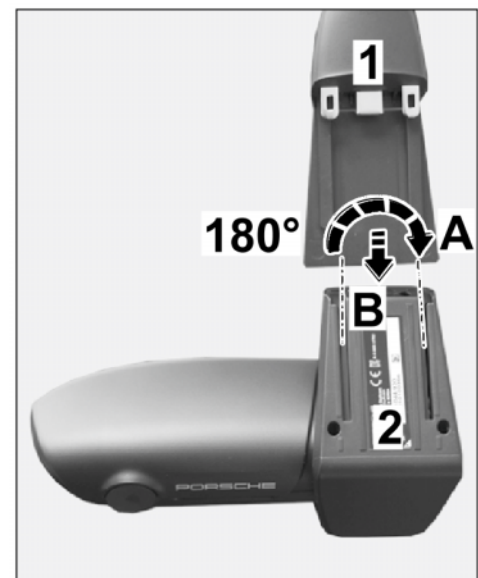

Figure 7

2.1.2 Trace the outline of the interior mirror base (⇒ *Figure 8-1-*) on the outside of the windshield using a marking pencil/chalk.

- 1 – Interior mirror base
- 2 – Outline of front camera base
- 3 – Interior mirror
- 4 – Front camera
- X – 295 mm/ 11.6 in
- Z – 26 mm/ 1.02 in

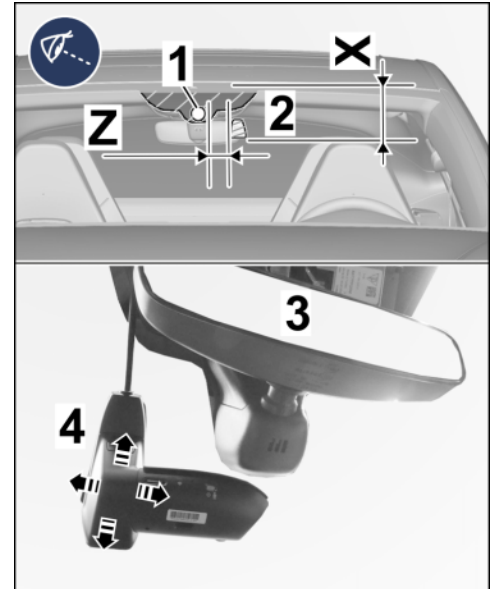

Figure 8

2.1.3 Copy dimensions X and Z on the windshield (⇒ *Figure 8 -top-*).
Dimension X = distance from lower edge of outline of front camera base to edge of roof: **Length 295 mm**

Dimension Z = distance from inner edge of outline of front camera base to inner edge of outline of interior mirror base (circle): **Length 26 mm**



Information

Observe the following points during positioning/alignment:

- Sufficient distance between front camera and interior mirror base: at least 5 mm/ 0.2 in!
- Get another person standing in front of the vehicle to check and confirm the horizontal alignment of the camera with the PORSCHE logo!

2.1.4 Position front camera with retainer plate in the vehicle at the marking on the windshield (⇒ *Figure 8 -Arrows-*).

2.1.5 Get another person to trace and shade in the outline of the retainer plate on the outside of the windshield using a marking pencil/chalk.

2.1.6 Clean the inside of the windshield in the bonding area for the retainer plate (shaded area) to remove any dust and grease.

2.2 Install front camera (dashcam) on the windshield

NOTICE

Adhesive films not prepared/installed correctly

- **Damage to adhesive films**
- **Inadequate adhesion of adhesive films**

- ⇒ Carefully clean the areas on which you intend to stick the film to ensure that all traces of oil, grease and silicone are completely removed.
- ⇒ Do not touch the bonding surfaces.
- ⇒ Object (adhesive film, vehicle, etc.) and ambient temperature: Minimum temperature 15°C / 59°F.

2.2.1 Pull 3M privacy film off the backing sheet (⇒ *Figure 9*).

- 1 - 3M privacy film
- 2 - Marked bonding surface
- 3 - Interior mirror base

2.2.2 Position 3M privacy film on the marked bonding surface on the windshield (⇒ *Figure 9*) and stick it on.

2.2.3 Carefully affix 3M privacy film using a plastic squeegee, starting from the center and moving towards the edge.

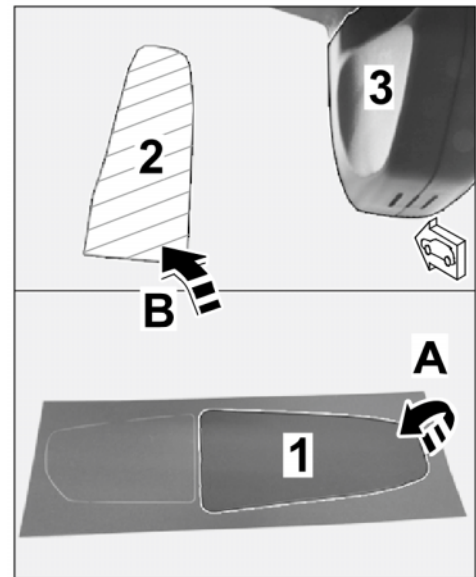

Figure 9

2.2.4 Pull protective film off the front camera retainer plate (⇒ *Figure 10-top-*).



Information

Observe the following points during positioning/alignment:

- Sufficient distance between front camera and interior mirror base: at least 5 mm/ 0.2 in!
- Get another person standing in front of the vehicle to check and confirm the horizontal alignment of the camera with the PORSCHE logo!

Align front camera with retainer plate symmetrically with respect to the 3M privacy film (⇒ *Figure 10-bottom-*).

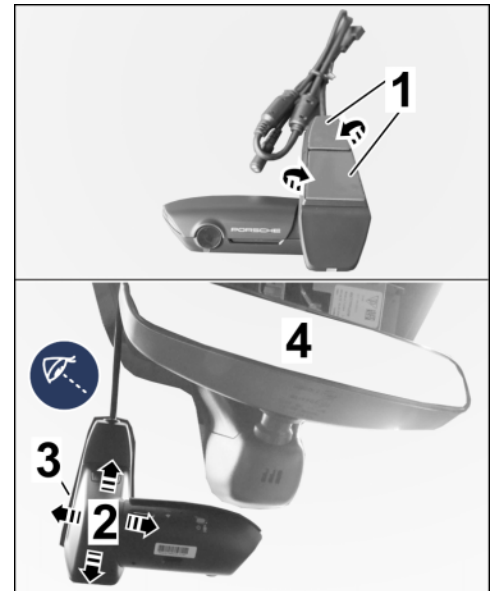

Figure 10

2.2.5 Press front camera with retainer plate firmly onto the 3M privacy film on the windshield.

3 Route and connect electric wire harness

- 1 – Interior mirror
- 2 – Installation position of PORSCHE front camera (dashcam)
- 3 – Electric wire harness
- 4 – Ground pin MB11
- 5 – Fuse carrier (under front seat, left)

Line routing (⇒ *Figure 11*):

- Front camera → headliner/roof console → along windshield frame → left A-pillar (top) → along A-pillar → ground pin MB11 (LHD) → fuse carrier under front seat (left)

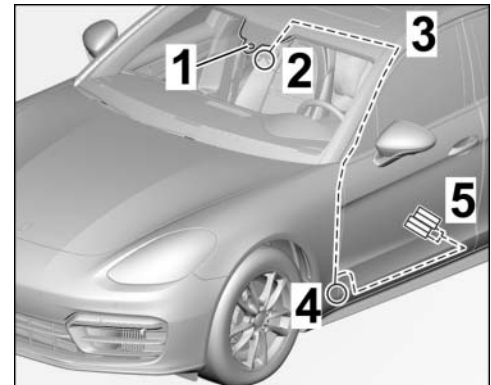

Figure 11

- 3.1 Expose fuse box underneath the front seat (left)
- 3.1.1 Loosen the front seat (left) and carefully tilt it to the rear. ⇒ *Workshop Manual '720119 Removing and installing front seat'*
- 3.1.2 Loosen fuse carrier under the front seat (left). ⇒ *Workshop Manual '978409 Loosening and securing fuse box under front seat'*



Information

Route electric wire harness along existing wiring, if installed.

Make sure that safety components (airbags, etc.) are still working correctly!

- 3.2 Routing wire harness

- 3.2.1 On the connector side, push one protective foam roll onto the wire harness for the front camera retainer plate and the (3-wire) wire harness.
- 3.2.2 Connect plug connection (3-pin) (⇒ *Figure 13 -Arrows-*).

- 1 – Protective foam roll
- 2 – Wire harness on front camera retainer plate
- 3 – Wire harness (3-wire)
- 4 – Branch for 2nd camera

- 3.2.3 Route wire harness for front camera (dashcam) to the roof console.

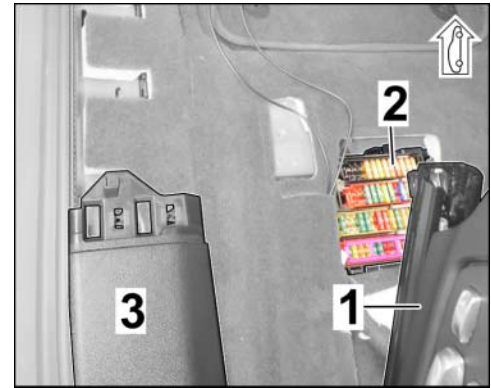

Figure 12

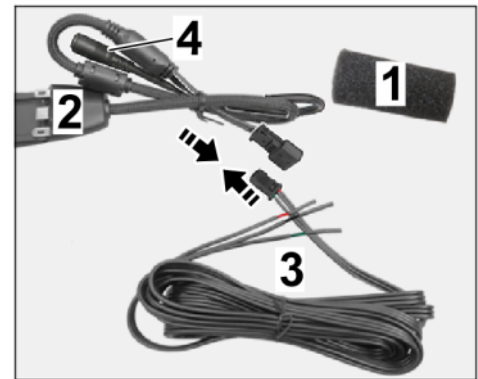

Figure 13

3.2.4 Push protective foam roll over the (3-pin) plug connection (⇒ *Figure 14*).

- 1 – Protective foam roll
- 2 – Plug connection (3-pin)
- 3 – Wire harness (3-wire)
- 4 – Branch for 2nd camera

Secure (3-pin) plug connection to existing components/lines in the roof console area with tie-wraps.

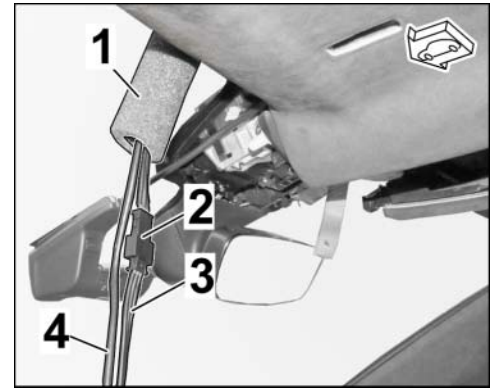

Figure 14

3.2.5 Tie back branch for 2nd camera (⇒ *Figure 14-4*) and secure it to existing components/lines in the roof console area using another protective foam roll.

3.2.6 Route the rest of the wire harness as follows (⇒ *Figure 15*):

- 1 – Wire harness (3-wire)
- 2 – BK 0.5² line
- 3 – Ground pin 11 (LHD)
- 4 – Fuse carrier under front seat (left)

- Roof console → under headliner along windshield frame → left A-pillar (top) → along A-pillar → BK 0.5² line → ground pin 11 (LHD) → GN 0.5² and RD 0.5² lines → fuse carrier under front seat (left)

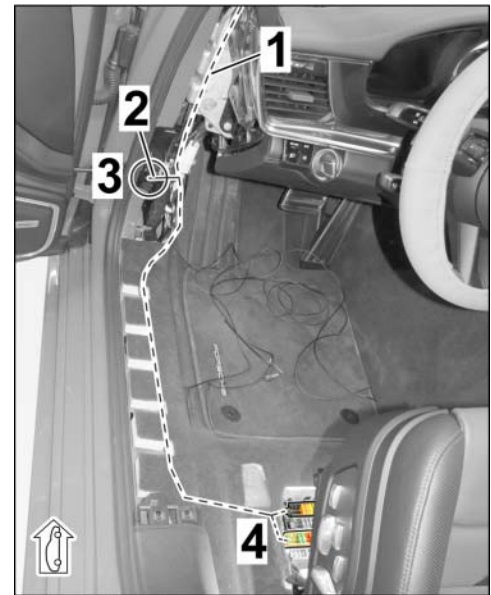

Figure 15

3.3 Connect electric wire harness

Function/line:	Connection point on left-hand drive (LHD) vehicle
Ground Terminal 31 = BK; 0.5 ²	Cable ring eyelet A6 (N .017.506.5) on ground pin MB11 (left A-pillar)
Ignition positive Terminal 15 = GN; 0.5 ²	Socket contact, 4.8 x Ø 1.0 mm ² (N.907.326.01) in slot 11, fuses in row A (A11)
Permanent positive Terminal 30 = RD; 0.5 ²	Socket contact, 4.8 x Ø 1.0 mm ² (N.907.326.01) in slot 11, fuses in row C (C11)

3.3.1 Open fuse holders in row A and C.

3.3.2 Shorten lines GN; 0.5² and RD; 0.5² to the relevant fuse holders and crimp the relevant contacts.

3.3.3 Connect power supply as shown in the table (⇒ *Figure 16*).

- 1 – Fuse carrier
- A – Fuse strip A
- C – Fuse strip C

3.3.4 Close fuse holders in row A and C and install with the fuse carrier into the seat well. ⇒ *Workshop Manual '978409 Loosening and securing fuse box under front seat'*

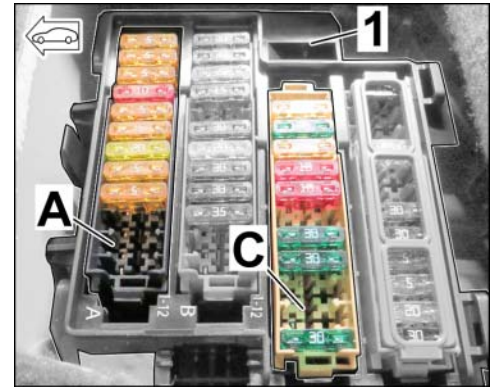

Figure 16

3.3.5 Protect the front camera power supply with new fuses (⇒ *Figure 16-A11 and C11*).

Fuse: **Required value 5 A**

3.3.6 Route BK; 0.5² line (terminal 31) to ground pin MB11, shorten it and install it on ground pin MB11 using cable ring eyelet A6 (⇒ *Figure 17*).

- 1 – BK; 0.5² line (terminal 31)
- 2 – Ground pin MB11 (left-hand drive)
- 3 – Wire harness (3-wire)

**Tightening torque 9 Nm
(6.5 ftlb.)**

3.4 Secure routed wire harness to existing lines/components in the vehicle with tie-wraps without tensile stress and so that no chafing occurs.

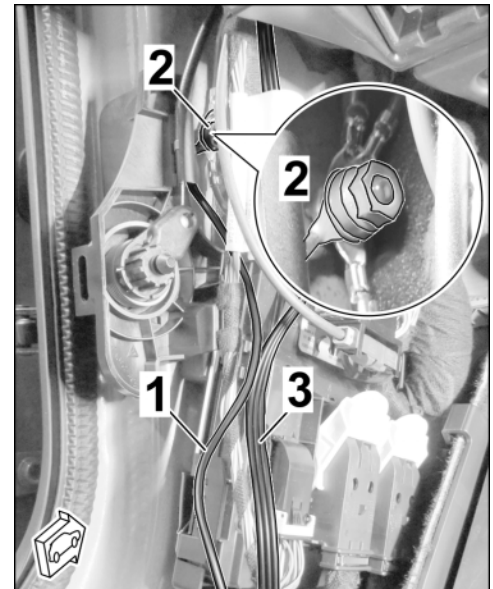

Figure 17

4 Concluding work in vehicle interior

4.1 Secure (left) front seat. ⇒ *Workshop Manual '720119 Removing and installing front seat'*

4.2 Assemble inner door sill trim and (left) A-pillar area.

4.3 Secure front headliner. ⇒ *Workshop Manual '708419 Removing and installing headliner'*

4.4 Assemble (internal) rear-view mirror and front roof area.

Coding: 5 Code the PORSCHE front camera (dashcam) in Dealer mode

5.1 Preparatory work

- 1 – PORSCHE front camera
- 2 – Micro SD memory card (32 GB)
- 3 – Retainer plate
- 4 – Power button
- 5 – WiFi status LED display
- 6 – PRESS (release button)

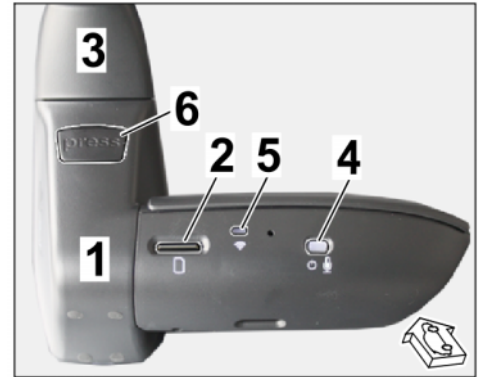

Figure 18

- 5.1.1 Remove micro SD memory card (32 GB, ⇒ *Figure 18-2-*) from card slot for front camera.
- 5.1.2 With the ignition switched on, push the front camera (dashcam ⇒ *Figure 18-1-*) into the retainer plate on the windshield (⇒ *Figure 18-3-*)
- 5.1.3 Press the power button (⇒ *Figure 18-4-*) for 10 seconds until you hear the second double beeping sound.
- 5.1.4 The front camera (dashcam) starts in Dealer mode: WiFi LED (⇒ *Figure 18-5-*) lights up "yellow".

5.2 Connect the front camera (dashcam) to the device (tablet, smartphone or PC)



Information

The "Dealer mode" network ID name ends with a "D". A password is **NOT** required!

The language setting can be changed by following the menu prompts after opening the first page.

- 5.2.1 Search available networks for Dealer mode WiFi.
- 5.2.2 Open Dealer mode on the device (tablet, smartphone or PC) using any browser.
To do this, enter "**192.168.1.1/diagnostics**" in the browser's address line.
- 5.2.3 Displays in "Dealer mode" main menu:

Options: (⇒ *Figure 19*)

- 1 – Browser's address line
- 2 – "Options" menu item

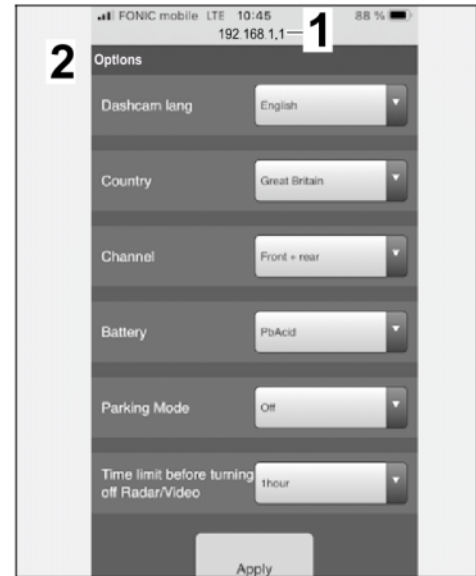

Figure 19

Diagnostics: (⇒ *Figure 20*)

- 1 – Browser's address line
- 2 – "Diagnostics" menu item

5.3 Basic settings for front camera (dashcam) in the "Options" menu item (⇒ *Figure 19*)

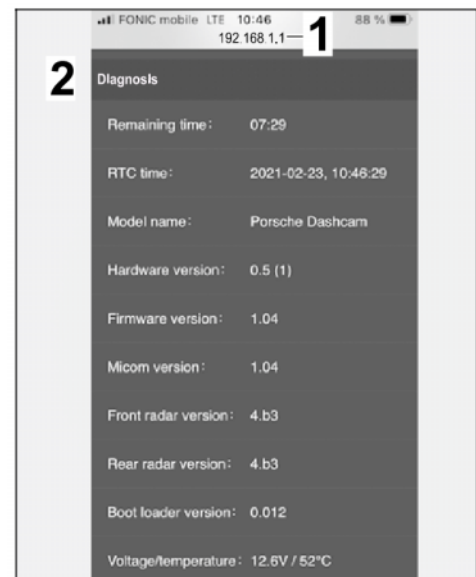

Figure 20

- 5.3.1 Change the default language "English" to the desired language:
- 1 – Default language "English"
 - 2 – German

For example: German (⇒ *Figure 21*)

- Up to 19 different languages can be selected.

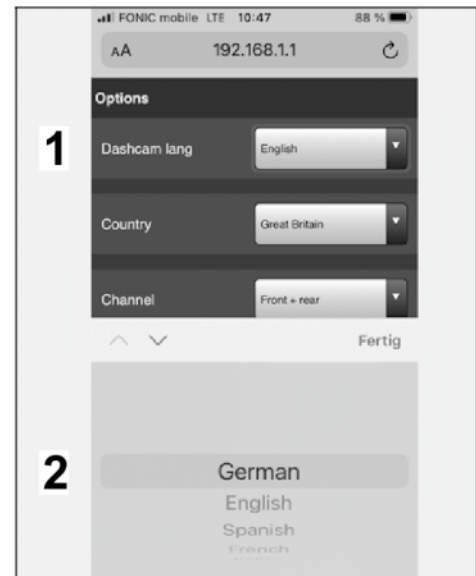

Figure 21



Information

ONLY for cameras with serial numbers "PDF2101*****", the country can be selected directly via the app on the customer's device (smartphone/tablet).

Country selection is possible for cameras, starting with the serial number "PDF2102*****"!

If the relevant country is **NOT** displayed in the drop-down menu: Please select "Global".

- 5.3.2 Select the country (⇒ *Figure 22*).
- 1 – Serial number of front camera (dashcam)
 - 2 – Country
 - 3 – Great Britain

- Up to 48 countries are currently available for selection.
- The Country selection screen includes, for example: Units of measurement, frequencies and also legal regulations of the respective country.
- **Panamera:** ⇒ Choose Region/State/Country by selecting the appropriate flag.

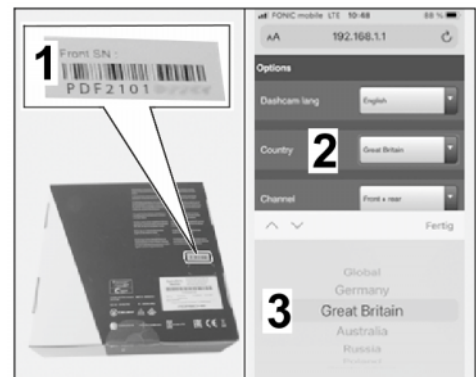

Figure 22

5.3.3 Select the required camera channel
(⇒ Figure 23).

- 1 - Channel
 - 2 - Front + Rear
- **TEQUIPMENT:** ⇒ "Front Only"
(front camera) is preset.

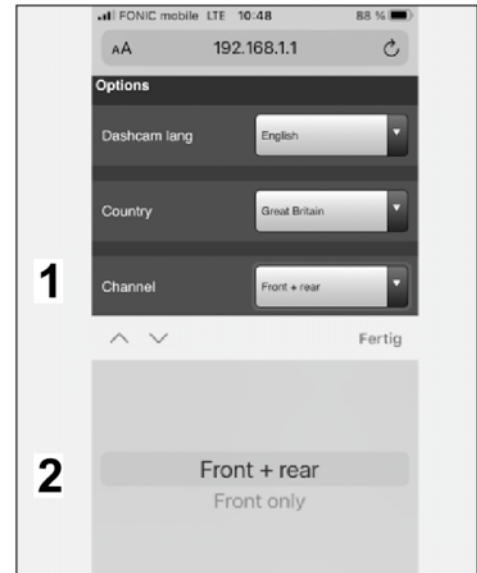

Figure 23



Information

Check which vehicle electrical system battery is installed in the vehicle if necessary by entering the vehicle identification number (VIN) in the Porsche Central Service System (PCSS).

Background: The front camera shuts down if the correct battery voltage (switch-off threshold) is not reached over a period of 5 minutes.

- Switch-off threshold for lead-acid battery (PbAcid) = 11 V
- Switch-off threshold for lithium-ion battery (LiFePO) = 13 V

5.3.4 Select the battery type (⇒ *Figure 24*)

- 1 - Battery
 - 2 - PbAcid
- Select the vehicle electrical system battery installed in the vehicle.
 - **Panamera:** ⇒ Lead-acid battery (PbAcid)

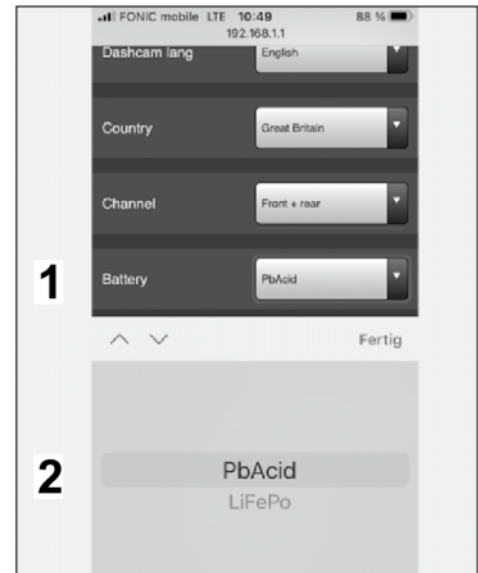

Figure 24

5.3.5 Select Park mode (⇒ *Figure 25*)

- 1 - Park mode
 - 2 - Off
- Depending on the approval for the respective vehicle.
 - **Panamera:** ⇒ Select "On".

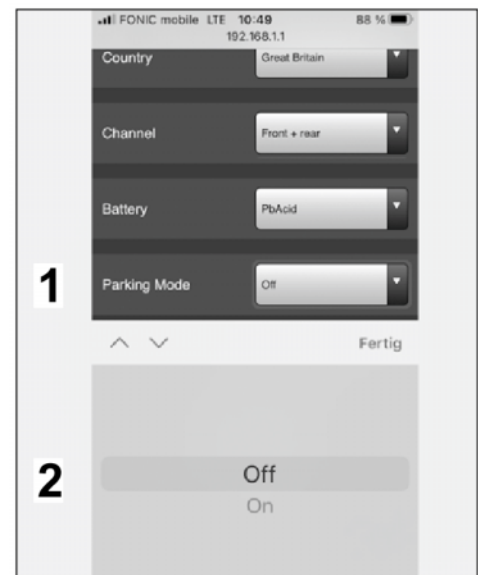
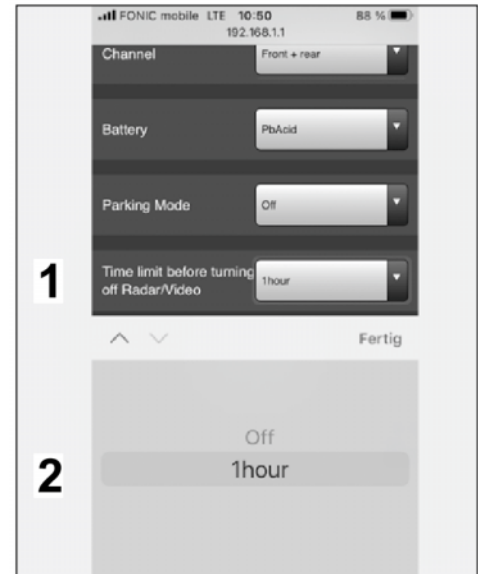

Figure 25

5.3.6 Select the time limit (⇒ *Figure 26*)

- 1 – Time limit until radar/video is switched off
 - 2 – 1 hour
- Turn off radar/video monitoring in Park mode (battery management). After the selected time limit, fast activation of the monitoring system ONLY occurs if the vehicle shakes/vibrates!
 - **Panamera:** ⇒ Skip. Leave the default setting.

*Figure 26*

5.4 Cancel Dealer mode (WiFi LED is still yellow)

5.4.1 Close the browser and switch off ignition.

5.4.2 Pull the front camera (dashcam) off the retainer plate by pressing "PRESS" (release button).

5.4.3 Insert micro SD memory card (32 GB) in the front camera (dashcam).

5.4.4 Install the front camera (dashcam) in the retainer plate.

5.5 The settings configured under Step 5.3 are set when the ignition is switched on again.

5.6 Format the micro SD memory card (32 GB)

5.6.1 Switch on ignition.

5.6.2 Press the power button quickly 6 times in a row within 3 seconds.

Announcements via front camera speaker: "Formatting..." and "Formatting complete."

Diagnostics: 6 Perform diagnostics on front camera (dashcam) – **ONLY** if necessary!

Information can be displayed, function tests can be run and results can be stored in the "Diagnostics" menu item.

6.1 Information about the model name, hardware and software version, radar and more (⇒ *Figure 27*).

- 1 – Model name
- 2 – Hardware version
- 3 – Software version

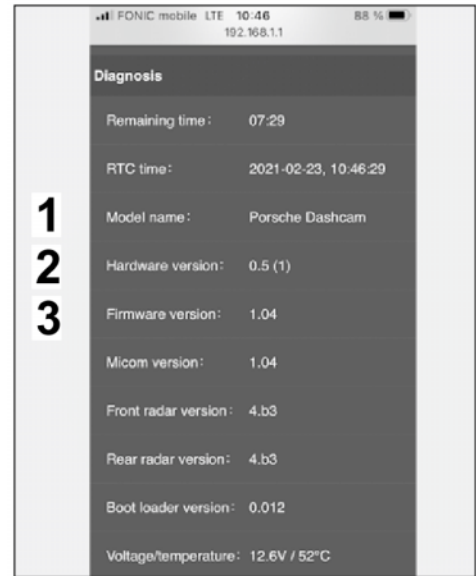

Figure 27

6.2 Display of live images from front camera, connection status, memory card status, GPS and radar status and more (⇒ *Figure 28*).

- 1 – Front camera live image
- 2 – Rear camera status (if installed)
- 3 – Micro SD memory card contents
- 4 – GPS status
- 5 – GPS coordinates

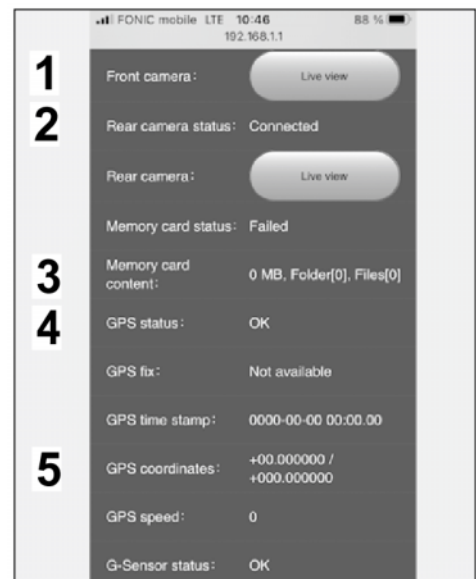

Figure 28

6.3 Display of radar status, possible tests for LED lights, loudspeaker and microphone (⇒ Figure 29)

- 1 – Radar status
- 2 – LED Lights test
- 3 – Loudspeaker test
- 4 – Microphone test

6.4 The fault report can be stored on the micro SD memory card (32 GB). To do this, use micro SD memory card in Dealer mode and select "Diagnostics" menu item in the front camera.

Installing:

7 Concluding work

7.1 Read out the fault memories of all systems, work through any existing faults and erase the fault memories. ⇒ *Workshop Manual '0X03IN Diagnostic maintenance: diagnostic system and maintenance inter...'*

7.2 Disconnect the battery charger. ⇒ *Workshop Manual '2X00IN Work instructions after disconnecting the battery'.*

7.3 Vehicle handover to customer



Information

Please pass all this information on to the customer.

Also give the customer the PORSCHE dashcam operating instructions.

Also give the first 3 pages of these Installation and Conversion Instructions to the customer.

7.3.1 Download the app from the App Store to the customer's device (smartphone/tablet).

7.3.2 Select and set Region/State/Country (flag) in the app on the customer's smartphone/tablet.

7.3.3 Get the customer to perform firmware update using the app.

7.3.4 Format micro SD memory card (32 GB).

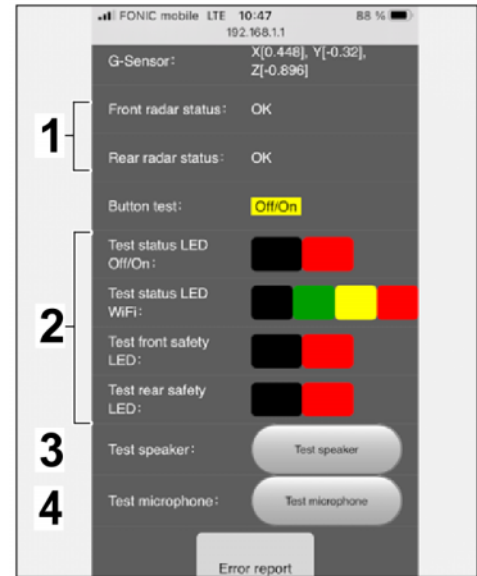

Figure 29

91 63 23 40: –Retrofitting PORSCHE front camera (dashcam) (1 x)–

Labor time: **298 TU**

- Includes:
- Installing retainer plate for PORSCHE front camera (dashcam) on windshield.
 - Routing and connecting electric wire harness.
 - Coding PORSCHE front camera (dashcam) in Dealer mode and formatting micro SD memory card.
 - Reading out fault memories and correcting and deleting faults.

Important Notice: Technical Bulletins issued by Porsche Cars North America, Inc. are intended only for use by professional automotive technicians who have attended Porsche service training courses. They are written to inform those technicians of conditions that may occur on some Porsche vehicles, or to provide information that could assist in the proper servicing of a vehicle. Porsche special tools may be necessary in order to perform certain operations identified in these bulletins. Use of tools and procedures other than those Porsche recommends in these bulletins may be detrimental to the safe operation of your vehicle, and may endanger the people working on it. Properly trained Porsche technicians have the equipment, tools, safety instructions, and know-how to do the job properly and safely. Part numbers listed in these bulletins are for reference only. The work procedures updated electronically in the Porsche PIWIS diagnostic and testing device take precedence and, in the event of a discrepancy, the work procedures in the PIWIS Tester are the ones that must be followed.

© 2022 Porsche Cars North America, Inc.