



Subject: APPLE CARPLAY™ / ANDROID AUTO™ FREQUENTLY ASKED QUESTIONS (FAQ)	Service Alert No.: SA-026/22
	Last Issued : 04/27/2022

BULLETIN NOTES

This Service Alert supersedes the previously issued SAs listed below. The changes are noted below in Red.

Previously Issued SAs:	Date(s) Issued
SA-029/21	06/04/2021 and 04/26/21
SA-070/20	10/15/20
SA-001/19	04/05/19, 3/27/19, 01/24/19, 01/04/19
SA-046/18	11/6/18 and 10/24/18

APPLICABLE MODEL(S)/VINS

2014-2022 Mazda3	2016-2022 CX-5	2020-2022 CX-30
2016-2021 Mazda6	2016-2022 CX-9	2022 MX-30
2016-2022 CX-3	2016-2022 MX-5	2023 CX-50

NOTE: The following vehicles are not equipped with Apple CarPlay™ / Android Auto™, but it can be activated using MDARS. See Activation instructions on MGSS -> Infotainment -> MAZDA CONNECT Updates -> [Apple Carplay / Android Auto MDARS Activation Instructions](#)

- 2019-2021 Mazda3, 4 Door Sedan, Standard (base model)
- 2020-2021 CX-30 Standard (base model)



CONSUMER NOTICE: The information and instructions in this bulletin are intended for use by skilled technicians. Mazda technicians utilize the proper tools/ equipment and take training to correctly and safely maintain Mazda vehicles. These instructions should not be performed by "do-it-yourselfers." Customers should not assume this bulletin applies to their vehicle or that their vehicle will develop the described concern. To determine if the information applies, customers should contact their nearest authorized Mazda dealership. Mazda North American Operations reserves the right to alter the specifications and contents of this bulletin without obligation or advance notice. All rights reserved. No part of this bulletin may be reproduced in any form or by any means, electronic or mechanical---including photocopying and recording and the use of any kind of information storage and retrieval system ---without permission in writing.

DESCRIPTION

Frequently Asked Questions (FAQ)

FAQ	Answer
The installation instructions are missing from the Smart phone Screen Mirroring Kit (Apple CarPlay™/Android Auto™ retrofit installation kit)	Click the model below for the Installation instructions: <ul style="list-style-type: none"> • 2014-2018 Mazda3 • 2019-2022 Mazda3 • 2016-2021 Mazda6 • 2016-2021 MX-5 • 2016-2021 CX-3 • 2020-2022 CX-30 • 2016 CX-5 • 2017-2022 CX-5 • 2016-2022 CX-9
Cannot operate Apple CarPlay™	Refer to MGSS online CANNOT OPERATE Apple CarPlay™ [ENTERTAINMENT SYSTEM [WITH CENTER DISPLAY]]
Cannot operate Android Auto™	Refer to MGSS online CANNOT OPERATE Android Auto™ [ENTERTAINMENT SYSTEM [WITH CENTER DISPLAY]]
Cannot operate Android Auto™ or some functions do not work.	During Android Auto set up, all permissions and requests may have not been accepted by the customer. Do the following: <ol style="list-style-type: none"> 1. Delete Android Auto from the customers phone. 2. Unpair the customers phone from the vehicle. 3. Connect the customers phone to the smartphone Un pair port. NOTE: Use a high-quality, certified smart phone cable. 4. During Android Auto set up, accept all permissions and requests.
Where do I find support for Apple CarPlay™	Go to Apple Support
Where do I find support for Android Auto™	Go to Android Auto Help
What phone do I need to operate Apple CarPlay™	<ul style="list-style-type: none"> • iPhone 5 or above • For best performance, update iPhone to the latest iOS version • Siri® must be enabled to use Apple CarPlay • Apple Lightning® to USB smart phone cable or a high-quality, certified smart phone cable

CONSUMER NOTICE: The information and instructions in this bulletin are intended for use by skilled technicians. Mazda technicians utilize the proper tools/ equipment and take training to correctly and safely maintain Mazda vehicles. These instructions should not be performed by "do-it-yourselfers." Customers should not assume this bulletin applies to their vehicle or that their vehicle will develop the described concern. To determine if the information applies, customers should contact their nearest authorized Mazda dealership. Mazda North American Operations reserves the right to alter the specifications and contents of this bulletin without obligation or advance notice. All rights reserved. No part of this bulletin may be reproduced in any form or by any means, electronic or mechanical--including photocopying and recording and the use of any kind of information storage and retrieval system ---without permission in writing.

	<p>Correct: Lightning to USB</p>	
	<p>Incorrect: Lightning to USB-C</p>	
	<p>Incorrect: USB-C Female to USB Male Adapter</p>	
<p>For additional information, go to Mazdausa.com -> OWNERS -> HOW TO USE -> OWNER'S MANUALS -> APPLE CARPLAY QUICK START GUIDE</p>		
<p>What phone do I need to operate Android Auto™</p>	<ul style="list-style-type: none"> • Android phone running 5.0 (Lollipop) or higher • Android 6.0 (Marshmallow) or higher is recommended • High-quality, certified smart phone cable <p>NOTE: The parking brake must be engaged before getting started with setup. For additional information, go to Mazdausa.com -> OWNERS -> HOW TO USE -> OWNER'S MANUALS -> ANDROID AUTO QUICK START GUIDE</p>	
<p>Cannot operate Apple CarPlay™ or Android Auto™</p>	<p>1. Confirm that the smart phone cable is connected to the port labeled with a smartphone icon.</p> <p>NOTE:</p> <ul style="list-style-type: none"> • On the 2019 Mazda3, there is no USB port labeled with a 	

CONSUMER NOTICE: The information and instructions in this bulletin are intended for use by skilled technicians. Mazda technicians utilize the proper tools/ equipment and take training to correctly and safely maintain Mazda vehicles. These instructions should not be performed by "do-it-yourselfers." Customers should not assume this bulletin applies to their vehicle or that their vehicle will develop the described concern. To determine if the information applies, customers should contact their nearest authorized Mazda dealership. Mazda North American Operations reserves the right to alter the specifications and contents of this bulletin without obligation or advance notice. All rights reserved. No part of this bulletin may be reproduced in any form or by any means, electronic or mechanical--including photocopying and recording and the use of any kind of information storage and retrieval system ---without permission in writing.

smartphone icon. Both USB ports will accept the Apple CarPlay™ or Android Auto™ cable.



2. Confirm that a high-quality certified smart phone cable is used.
3. Disconnect the battery and wait 2-3 minutes.
4. Reconnect the battery
5. Perform infotainment factory reset and confirm proper operation.

2023 CX-50 Cannot operate Apple CarPlay™ or Android Auto™

1. Perform VEHICLE INQUIRY and check DRW46 Open/Closed status

- DRW46 Open - Perform DRW46 Repair Procedure and submit claim.
- DRW46 Closed - Go to next step
- DRW46 is not shown - Go to next step.

2. Connect MDARS and check for DTC's stored.

3. Check CMU software version.

Go to Infotainment Settings -> System Settings -> System Information -> Version Information

Is the CMU software version 11014 or later?

- **Yes:** Contact Hotline for technical support.
- **No:** Update CMU software to 11014 or later, then go to next step.

4. Connect MDARS and start a new session. Confirm no DTC's are stored.

5. Submit a Warranty Claim for CMU software update using the CMU PNMC. T1117HRX 0.3 hours.

Apple CarPlay™ freezes when answering or making phone calls. The device recovers when disconnecting and reconnecting the USB cable.

When making or answering a call, it operates normally, but the screen will freeze at times. The call drops, the screen shows the phone call and the counting has stopped.

This may be caused by the customer's device. No vehicle repairs are needed.

Tech Tip

Confirm the iPhone has the latest iOS version, then follow these steps checking CarPlay after each step.

1. Check vehicle connection:

CONSUMER NOTICE: The information and instructions in this bulletin are intended for use by skilled technicians. Mazda technicians utilize the proper tools/ equipment and take training to correctly and safely maintain Mazda vehicles. These instructions should not be performed by "do-it-yourselfers." Customers should not assume this bulletin applies to their vehicle or that their vehicle will develop the described concern. To determine if the information applies, customers should contact their nearest authorized Mazda dealership. Mazda North American Operations reserves the right to alter the specifications and contents of this bulletin without obligation or advance notice. All rights reserved. No part of this bulletin may be reproduced in any form or by any means, electronic or mechanical--including photocopying and recording and the use of any kind of information storage and retrieval system ---without permission in writing.

	<ul style="list-style-type: none"> • Wired connection: Confirm high-quality, certified smart phone cable • Wireless connection: Make sure that Wi-Fi and Bluetooth are enabled under Settings -> Wi-Fi and Settings -> Bluetooth <p>2. If Carplay doesn't activate automatically, look for the CarPlay logo on the vehicle infotainment display.</p> <p>3. Restart the iPhone and the vehicle.</p> <p>4. Make sure Siri is ON.</p> <p>5. If your iPhone isn't detected by CarPlay, make sure that CarPlay isn't restricted. Go to Settings -> Screen Time -> Content & Privacy Restrictions, then tap Allowed Apps and make sure that Carplay is enabled.</p> <p>6. Go to Settings -> General -> Carplay, then tap on Mazda -> tap Forget This Car. Setup CarPlay again.</p> <p>7. Confirm infotainment CMU has the latest software version.</p> <p>If there is still an issue connecting to CarPlay, refer the customer to Apple Support.</p>
<p>Apple CarPlay™: The Waze app or the Google Maps app is not displayed in the menu.</p>	<div data-bbox="963 869 1166 981" data-label="Image"> </div> <p>Waze Requirement: iPhone iOS 12.0 or higher and Waze version 4.43.4 or higher.</p> <p>Google Maps Requirement: iPhone iOS 12.0 or higher.</p>
<p>Cannot update CMU software after smart phone Cable Set Kit (P/N C922-V6-605) installation.</p>	<p>This may be caused by smart phone Cable Set Kit (P/N C922-V6-605) installation error. The hardware was installed before CMU software update by smart phone flash drive.</p> <p>Failure: In some cases, the CMU will not recognize the new HUB unit, so CMU software update by smart phone flash drive is not possible.</p> <p>Recovery: Proceed to Repair Procedure.</p>
<p>MAZDA CONNECT Navigation system is inoperative after smart phone Cable Set Kit (P/N C922-V6-605) installation.</p>	<p>Confirm that the Navigation SD Card was transferred from the old smart phone HUB unit to the new smart phone HUB unit.</p>

CONSUMER NOTICE: The information and instructions in this bulletin are intended for use by skilled technicians. Mazda technicians utilize the proper tools/ equipment and take training to correctly and safely maintain Mazda vehicles. These instructions should not be performed by "do-it-yourselfers." Customers should not assume this bulletin applies to their vehicle or that their vehicle will develop the described concern. To determine if the information applies, customers should contact their nearest authorized Mazda dealership. Mazda North American Operations reserves the right to alter the specifications and contents of this bulletin without obligation or advance notice. All rights reserved. No part of this bulletin may be reproduced in any form or by any means, electronic or mechanical--including photocopying and recording and the use of any kind of information storage and retrieval system ---without permission in writing.



When driving, Apple CarPlay™/Android Auto™ limits some functions such as scrolling. Apple/Google expects drivers to keep their eyes on the road and use Siri/Google Assistant instead of scrolling.

Apple CarPlay™ scrolling message while driving

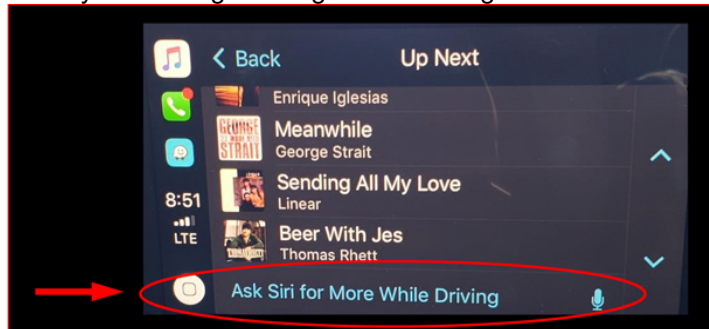

Android Auto™ scrolling message while driving

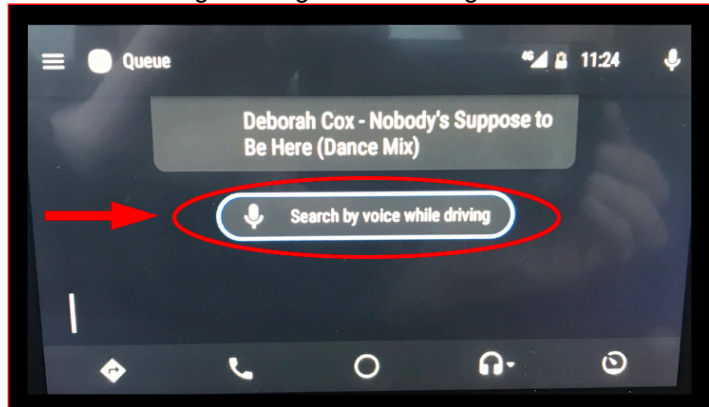

This is an Apple CarPlay™/Android Auto™ function. Vehicle infotainment system is functioning correctly.

**Apple CarPlay™
Android Auto™**

- Cannot scroll song list when driving.
- Cannot find songs when using Apple CarPlay™/Android Auto™

Apple CarPlay™: The Waze app or the Google Maps app does not open when using the steering wheel Voice Command

When using the steering wheel Voice Command button, the navigation system defaults to the Apple Maps app.

CONSUMER NOTICE: The information and instructions in this bulletin are intended for use by skilled technicians. Mazda technicians utilize the proper tools/ equipment and take training to correctly and safely maintain Mazda vehicles. These instructions should not be performed by "do-it-yourselfers." Customers should not assume this bulletin applies to their vehicle or that their vehicle will develop the described concern. To determine if the information applies, customers should contact their nearest authorized Mazda dealership. Mazda North American Operations reserves the right to alter the specifications and contents of this bulletin without obligation or advance notice. All rights reserved. No part of this bulletin may be reproduced in any form or by any means, electronic or mechanical--including photocopying and recording and the use of any kind of information storage and retrieval system ---without permission in writing.

button to set a navigation destination.

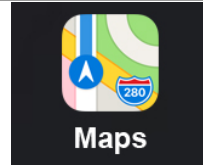

Waze app: Voice command is possible when selecting the Waze voice icon.

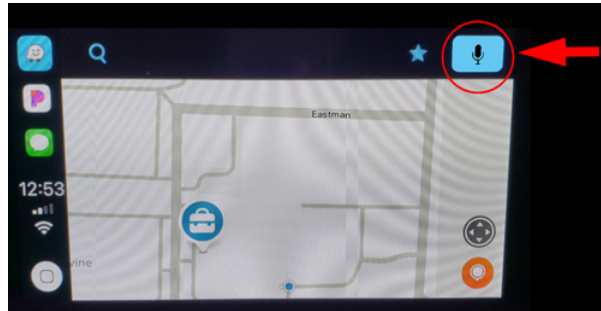

Google Maps app: Voice command is possible when selecting the Google Maps voice icon.

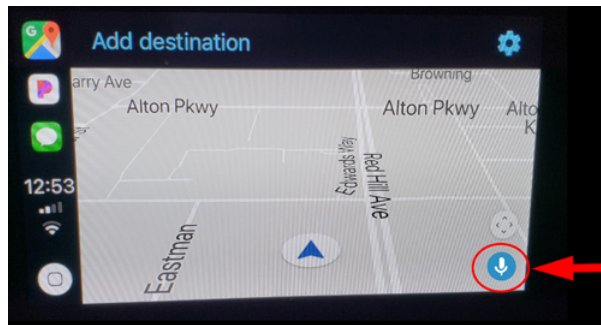

Android Auto™: The wrong navigation app opens when using the steering wheel Voice Command button.



When using the steering wheel Voice Command button to set a navigation destination, Android Auto™ defaults to the last navigation app that was used. Select the "Maps and Navigation" icon to set your default navigation app.

CONSUMER NOTICE: The information and instructions in this bulletin are intended for use by skilled technicians. Mazda technicians utilize the proper tools/ equipment and take training to correctly and safely maintain Mazda vehicles. These instructions should not be performed by "do-it-yourselfers." Customers should not assume this bulletin applies to their vehicle or that their vehicle will develop the described concern. To determine if the information applies, customers should contact their nearest authorized Mazda dealership. Mazda North American Operations reserves the right to alter the specifications and contents of this bulletin without obligation or advance notice. All rights reserved. No part of this bulletin may be reproduced in any form or by any means, electronic or mechanical---including photocopying and recording and the use of any kind of information storage and retrieval system ---without permission in writing.

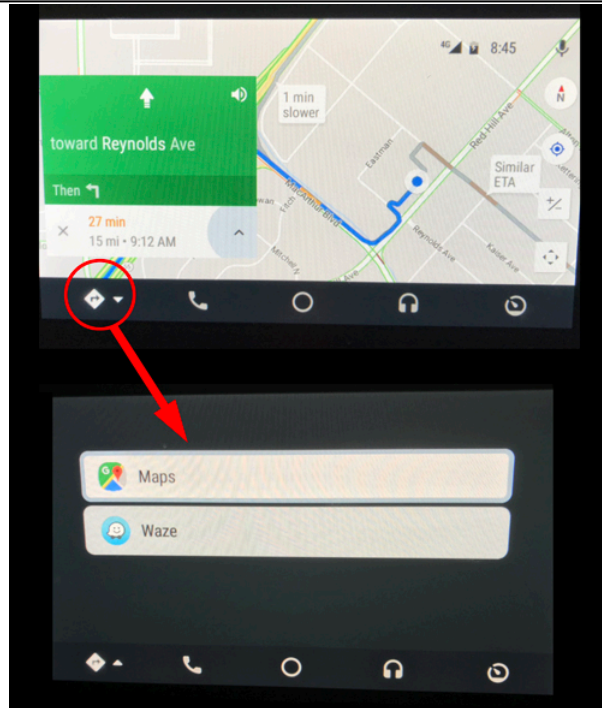

Apple CarPlay™: Double voice navigation is heard through the vehicle speakers.

This may be caused by Apple iPhone IOS 12.0 update. The customer sets a navigation destination on Google Maps, then sets a navigation destination on MAZDA CONNECT, double voice navigation is heard through the vehicle speakers.

Example:

Apple iPhone software IOS 12.0 update	
Google Maps destination set --> MAZDA CONNECT destination set	NG (double voice)
MAZDA CONNECT destination set --> Google Maps destination set	Good

Repair: This is an Apple IOS 12.0 issue. No vehicle repair is necessary.

CONSUMER NOTICE: The information and instructions in this bulletin are intended for use by skilled technicians. Mazda technicians utilize the proper tools/ equipment and take training to correctly and safely maintain Mazda vehicles. These instructions should not be performed by "do-it-yourselfers." Customers should not assume this bulletin applies to their vehicle or that their vehicle will develop the described concern. To determine if the information applies, customers should contact their nearest authorized Mazda dealership. Mazda North American Operations reserves the right to alter the specifications and contents of this bulletin without obligation or advance notice. All rights reserved. No part of this bulletin may be reproduced in any form or by any means, electronic or mechanical--including photocopying and recording and the use of any kind of information storage and retrieval system ---without permission in writing.

REPAIR PROCEDURE

(Cannot install CMU software after smart phone Cable Set Kit (P/N C922-V6-605) installation)

1. Disconnect the new smart phone HUB unit and the new smart phone cables from the CMU.

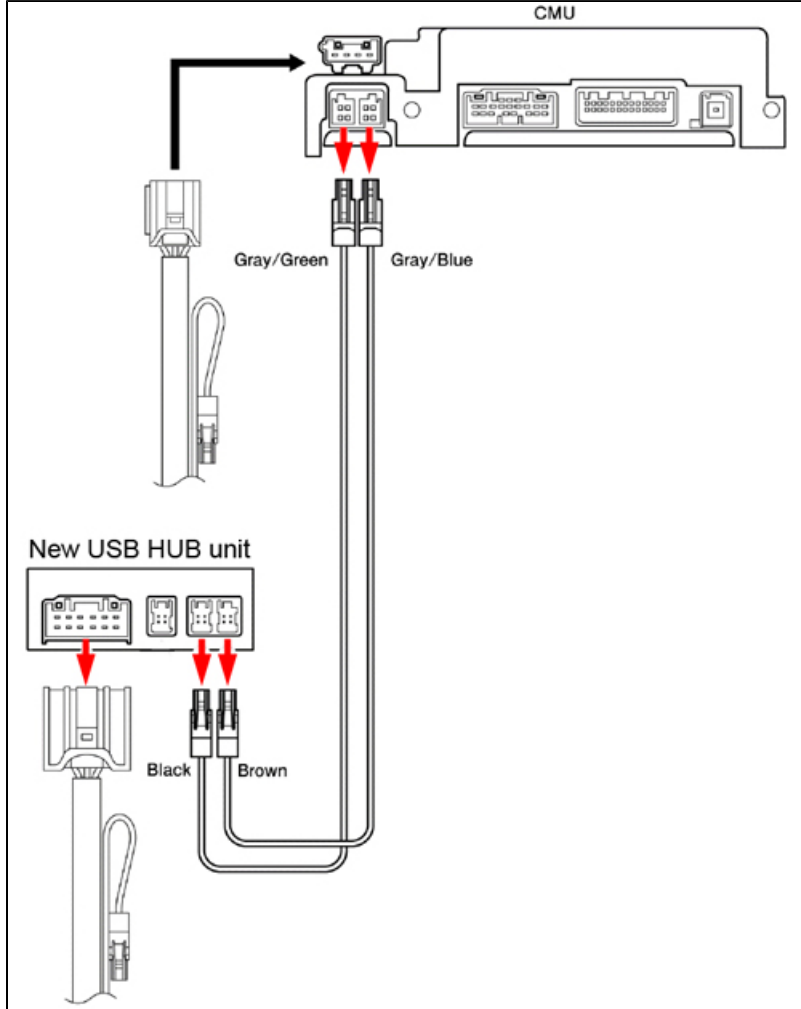

CONSUMER NOTICE: The information and instructions in this bulletin are intended for use by skilled technicians. Mazda technicians utilize the proper tools/ equipment and take training to correctly and safely maintain Mazda vehicles. These instructions should not be performed by "do-it-yourselfers." Customers should not assume this bulletin applies to their vehicle or that their vehicle will develop the described concern. To determine if the information applies, customers should contact their nearest authorized Mazda dealership. Mazda North American Operations reserves the right to alter the specifications and contents of this bulletin without obligation or advance notice. All rights reserved. No part of this bulletin may be reproduced in any form or by any means, electronic or mechanical---including photocopying and recording and the use of any kind of information storage and retrieval system ---without permission in writing.

2. Connect the old smart phone HUB unit and the old smart phone cable to the CMU.

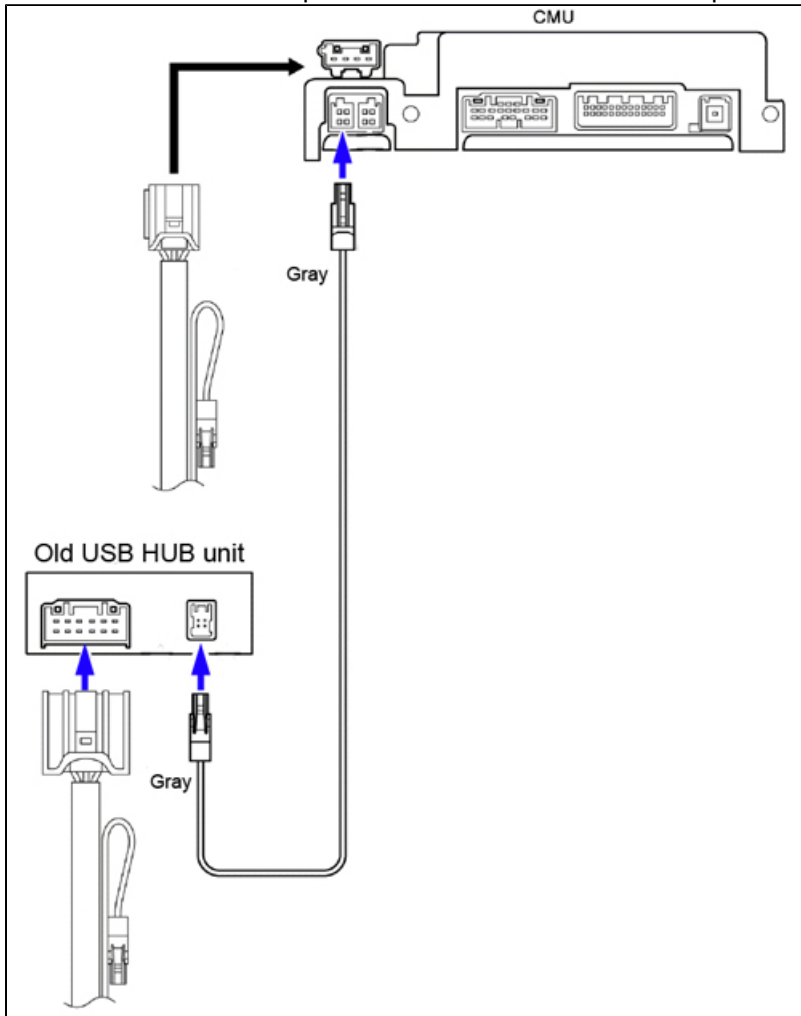

3. Update the CMU to software version 70.00.021B or later by smart phone flash drive.
4. Remove the old smart phone HUB unit and disconnect the old smart phone cable from the CMU.
5. Re-connect the new smart phone HUB unit and the new smart phone cables to the CMU.

CONSUMER NOTICE: The information and instructions in this bulletin are intended for use by skilled technicians. Mazda technicians utilize the proper tools/ equipment and take training to correctly and safely maintain Mazda vehicles. These instructions should not be performed by "do-it-yourselfers." Customers should not assume this bulletin applies to their vehicle or that their vehicle will develop the described concern. To determine if the information applies, customers should contact their nearest authorized Mazda dealership. Mazda North American Operations reserves the right to alter the specifications and contents of this bulletin without obligation or advance notice. All rights reserved. No part of this bulletin may be reproduced in any form or by any means, electronic or mechanical---including photocopying and recording and the use of any kind of information storage and retrieval system ---without permission in writing.