

June 1, 2022

Version 6

Carbon Buildup with Misfire DTCs

Supersedes 21-007, dated February 18, 2022, to revise the information highlighted in yellow.

AFFECTED VEHICLES

Year	Model	Trim Level	VIN Range
2016	Fit	ALL	After 3HG.....GM704625, After JHM.....GX026880
2017–20	Fit	ALL	ALL

REVISION SUMMARY

- Under AFFECTED VEHICLES, year and VIN Range have been updated.
- Under CORRECTIVE ACTION, the information was updated.
- Under INSPECTION PROCEDURE, the procedure was removed.

SYMPTOM

The MIL comes on with DTC P0300 (random misfire detected) or P0301–P0304 (cylinder misfire detected).

POSSIBLE CAUSE

Carbon buildup on the intake valves may be affecting combustion.

CORRECTIVE ACTION

Application	Initial misfire repair	If the misfire returns
2016–17 Fit	Repair Procedure	Normal Troubleshooting
2018–20 Fit	Software update and Repair Procedure	Normal Troubleshooting

NOTE: All Injector replacements for misfire prior to performing service bulletin 21-007, *Carbon Buildup with Misfire DTCs* may be subject to debit.

PARTS INFORMATION

Part Name	Part Number	Quantity
Intake Manifold Gasket	17105-5R0-004	4
Throttle Body Gasket	17107-5R0-004	1
EGR Port Gasket	17108-5R0-004	1

CUSTOMER INFORMATION: The information in this bulletin is intended for use only by skilled technicians who have the proper tools, equipment, and training to correctly and safely maintain your vehicle. These procedures should not be attempted by “do-it-yourselfers,” and you should not assume this bulletin applies to your vehicle, or that your vehicle has the condition described. To determine whether this information applies, contact an authorized Honda automobile dealer.

TOOL INFORMATION

Tool Name	Tool Number	Quantity
Carbon Cleaning Kit*	07AAK-5R7A100	1

*One kit will be auto-shipped to your dealership before the launch of this bulletin. Additional kits are available through the parts system.

NOTE: All information on assembly and contents of the kit is on page 5.

REQUIRED MATERIALS

Material Name	Part Number	Quantity
Carbon Cleaner Media (1 box repairs 3 vehicles)	07AAK-5R7A110	1
Masking Tape	Commercially available	4 strips

NOTE: Using any other type of media could damage the vehicle or might not repair the vehicle correctly. Use only the media listed in the table above for this repair.

WARRANTY CLAIM INFORMATION

The normal warranty applies.

2018-20 with CVT

Operation Number	Description	Flat Rate Time	Defect Code	Symptom Code	Template ID	Failed Part Number
1255D8	Update the PGM-FI software.	0.2 hr	06901	03217	A21007A	14711-5R7-A00
1100A4	Clean the intake ports of any carbon buildup. (Includes DTC clear)	1.6 hr				

2016-17 with CVT and 2016-20 with M/T

Operation Number	Description	Flat Rate Time	Defect Code	Symptom Code	Template ID	Failed Part Number
1100A4	Clean the intake ports of any carbon buildup. (Includes DTC clear)	1.6 hr	06901	03217	A21007B	14711-5R7-A00

Skill Level: Repair Technician

SOFTWARE INFORMATION

NOTE: Unnecessary or incorrect repairs resulting from a failure to update the diagnostic and reprogramming software are not covered under warranty.

Before beginning the repair, make sure all diagnostic and reprogramming software are updated as listed.

i-HDS Software Version	1.006.026 or later
HDS Software Version	3.104.014 or later
J2534 Rewrite Software Information	
PC Application Version	1.2.1.1
Database Update	12-MAR-2021 or later
NoticeDB Version	12-MAR-2021 or later

Update only the systems and software listed in this service bulletin.

American Honda has validated and approved the Denso DST-I as the vehicle communication interface (VCI) to support this service bulletin.

For more information about updating vehicle systems, refer to service bulletin 01-023, *Updating Control Units/Modules*.

Year/Trim Level	Vehicle System	Program ID (or later)
2018 LX	PGM-FI	37805-5R7-U540
2018 LX (With Sensing)		37805-5R7-U630
2018 Sport		37805-5R7-U730
2018 Sport (With Sensing)		37805-5R7-U830
2018 EX		37805-5R7-E830
2018 EX-L		
2019 LX		37805-5R7-AC20
2019 LX (With Sensing)		37805-5R7-AD20
2019 Sport		37805-5R7-AE20
2019 Sport (With Sensing)		37805-5R7-AF20
2019 EX		37805-5R7-AJ20
2019 EX-L		
2020 LX		37805-5R7-AN20
2020 LX (With Sensing)		37805-5R7-AP20
2020 Sport		37805-5R7-AQ20
2020 Sport (With Sensing)		37805-5R7-AR20
2020 EX		37805-5R7-AW20
2020 EX-L		

SOFTWARE UPDATE

NOTE:

- Make sure the 12-volt battery is fully charged before starting an update.
- Connect a fully charged jumper battery to the vehicle, and leave it connected during the entire procedure to maintain steady voltage.
- Do not use the GR8 because the vehicle requires a steady electrical current.
- Control module failure caused by the improper completion of a software update (early key cycle, low battery voltage, disconnected DLC cable, etc.) is not covered by warranty.
- If an error occurs during the update or the i-HDS freezes, **do not disconnect the battery or turn the ignition to OFF**. Reboot the i-HDS, and start over.
- To prevent control unit damage, do not operate anything electrical (headlights, audio system, brakes, A/C, power windows, door locks, etc.) during the update.
- Warranty reimbursement for technician labor is not allowed for **routine** checking/installation of any available software update.

1. Update the PGM-FI software using the J2534 Rewrite software with the DST-i. Refer to service bulletin 01-023, *Updating Control Units/Modules*.

CARBON CLEANER ASSEMBLY INSTRUCTIONS

NOTE: If the carbon cleaner tool is already assembled with new media cleaner, skip to REPAIR PROCEDURE on page 9.

1. Remove all the equipment from the carbon cleaner canister to ensure that the following items are included:
 - Inlet air pressure regulator
 - Nozzle with depth stopper
 - 5R7 intake port adaptor and spacer (can be reordered as 07AAK-5R7A130)
 - Two black silicone universal intake port adaptors and one blue silicone hose coupler. (only the blue silicone coupler is used)
 - Safety goggles
 - Carbon Cleaner Filter (not shown in photo, can be reordered as 07AAK-5R7A120)

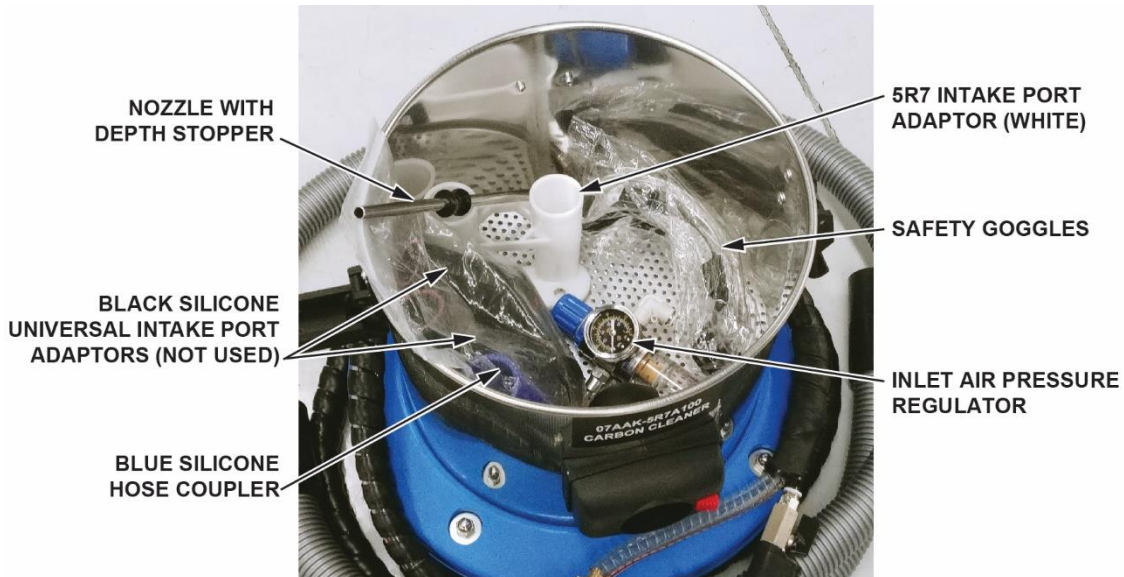

2. Install the air pressure regulator through the regulator bracket on the outside of the canister. Make sure you tighten the regulator nut to secure it.

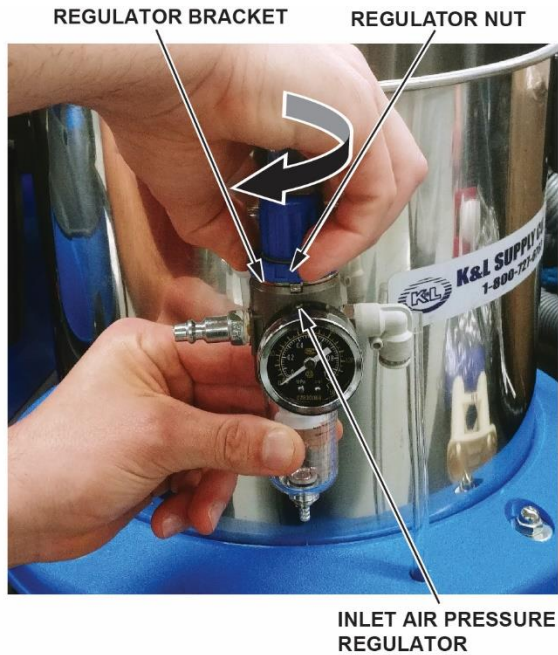

3. Install the appropriate air fitting on the air regulator for your shop's compressor lines.
4. Install the clear tube into the right end of the air regulator. To ensure that it is in place, tug lightly on the tube.



5. Install the filter on the rim of the canister. If it's not on properly, the motor assembly will not close.

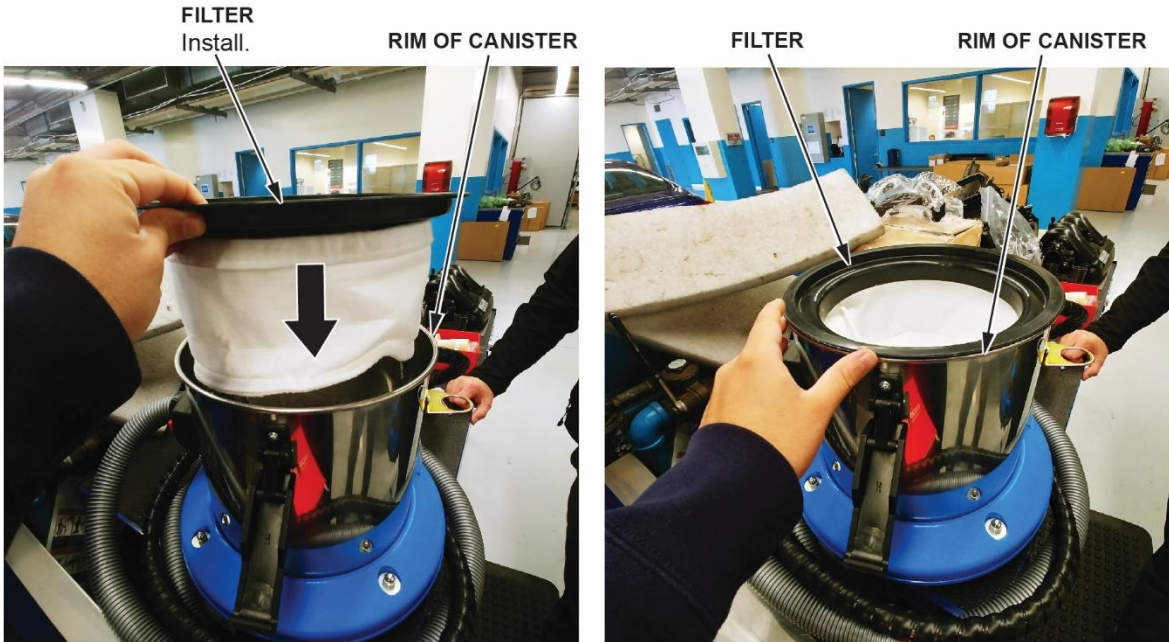

6. Fill the canister with new (unused) media to approximately 5 mm to 10 mm from the bottom of the suction hose receptacle.

NOTE: Using any other type of media could damage the vehicle or might not repair the vehicle correctly. Use only the media listed in the table above for this repair.

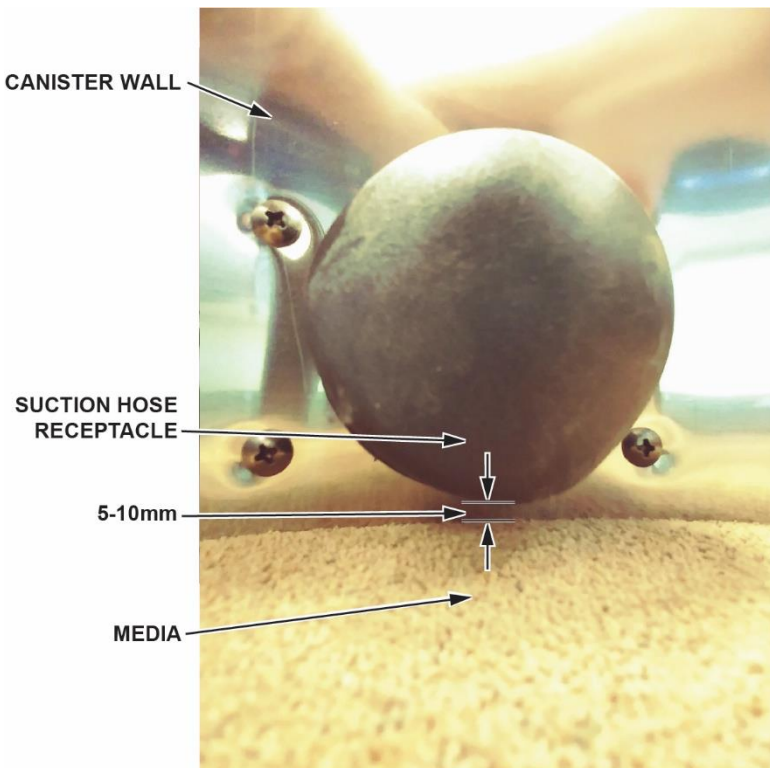

7. Install the motor assembly on top of the base. Use the latches on the sides to seal it to the base of the canister.



8. Install the nozzle on the handle assembly and tighten with a **15 mm** open-ended wrench.

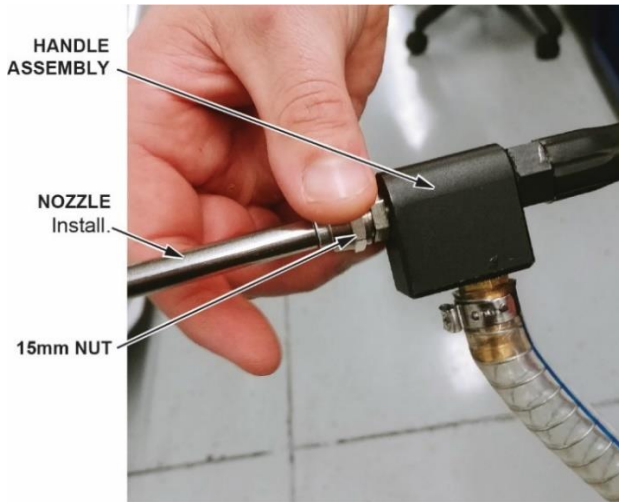

9. Confirm that the length from the tip of the nozzle to the depth stopper measures **80 mm**. If not, adjust the depth stopper so that it is.

NOTE: If the depth stopper isn't correctly adjusted, you may cause damage to the valves and valve stems.

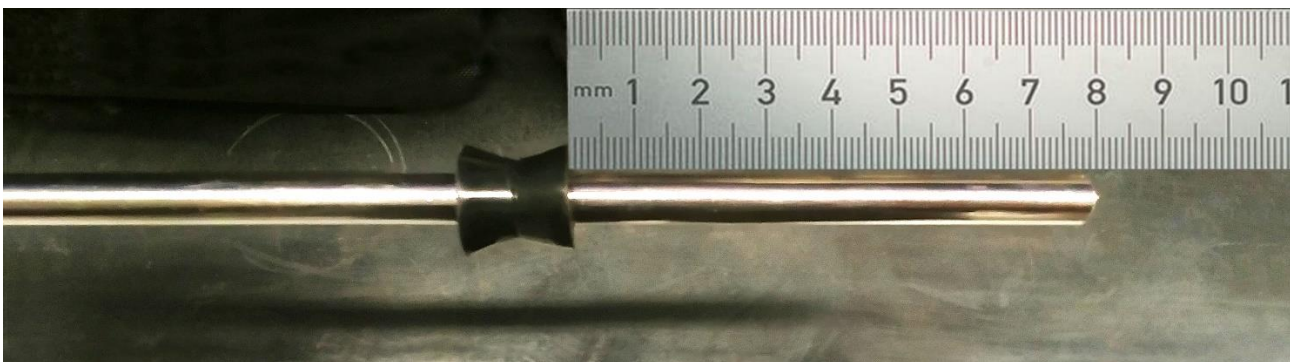

10. Insert the suction hose to the suction hose receptacle until you hear a click. Once it is all the way in, lightly tug on it to ensure that it's properly installed.

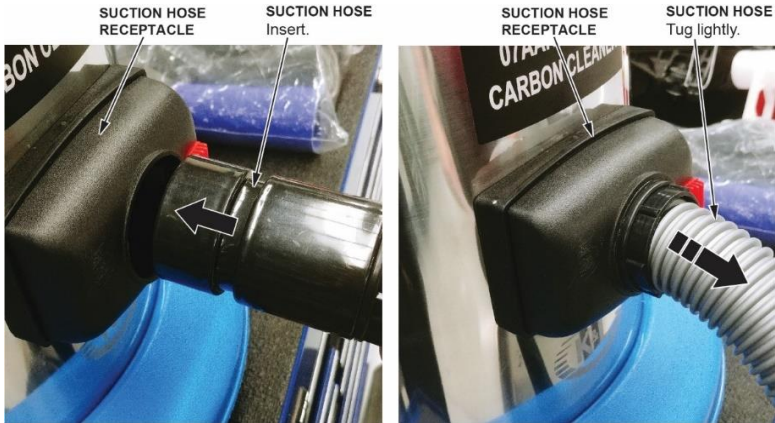

REPAIR PROCEDURE

1. Remove the intake manifold and insulator. See the service information.

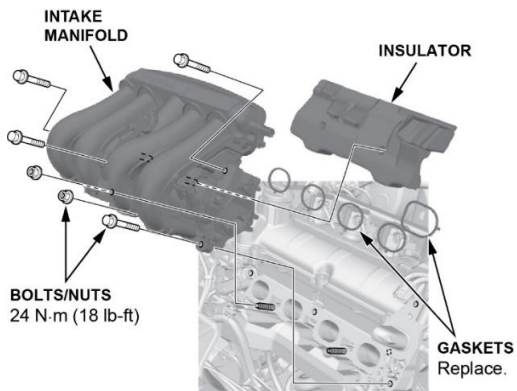

2. Remove the fuel rail cover.

NOTE: Do not remove the fuel rail.

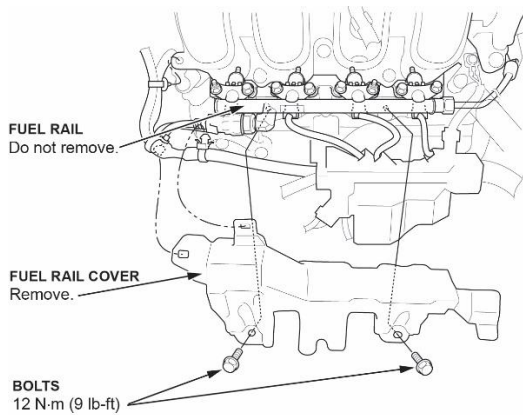

3. Raise the vehicle on a lift and remove the right front tire.

4. Turn the crankshaft to align the No.1 position at top dead center. The white mark on the crankshaft pulley lines up with the pointer.

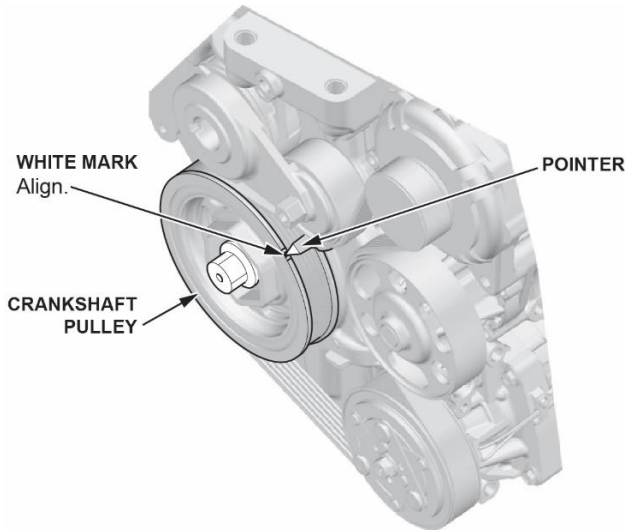

5. Confirm the intake valves A and B of cylinder #1 and #2 are closed.

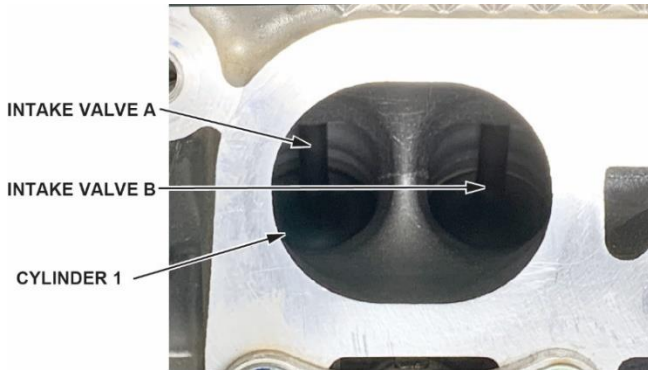

6. Tape off the ports on cylinders #3 and #4 to prevent debris from entering the ports.



7. Install the intake port adaptor on cylinders #1 and #2. Use the spacer from the kit and the intake manifold nut to ensure the adaptor is installed correctly. Torque the nut to **24 N·m (18 lb-ft)**.

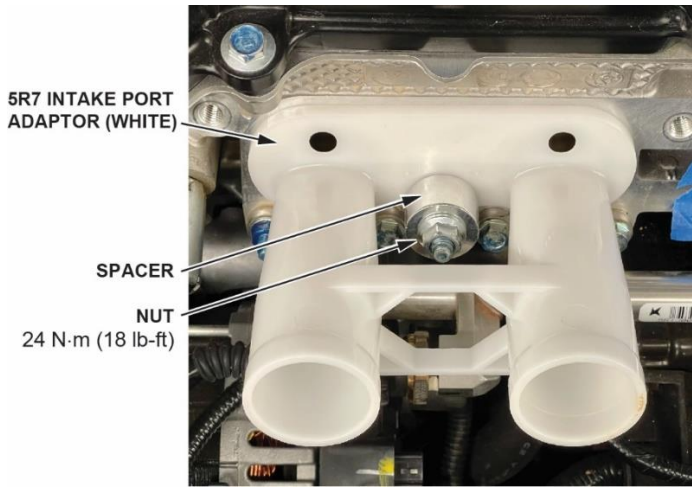

NOTE: Make sure the tabs on the inside of the adaptor are correctly inside the intake port. If they are not, it will not be flush with the cylinder head.

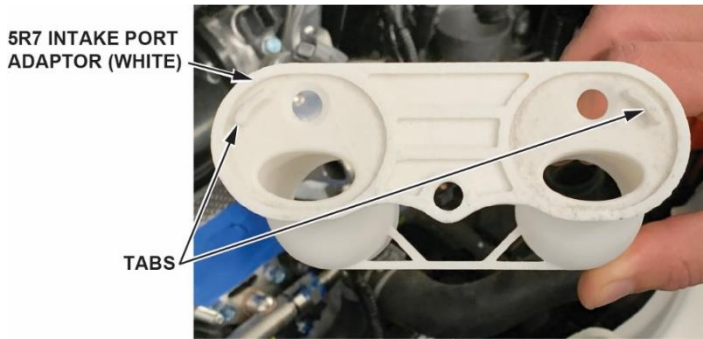

8. Attach the carbon cleaner suction hose to the port adaptor using the blue silicone hose coupler shown below.

NOTE: Make sure the carbon cleaner suction hose is attached to the larger end of the blue silicone hose coupler.

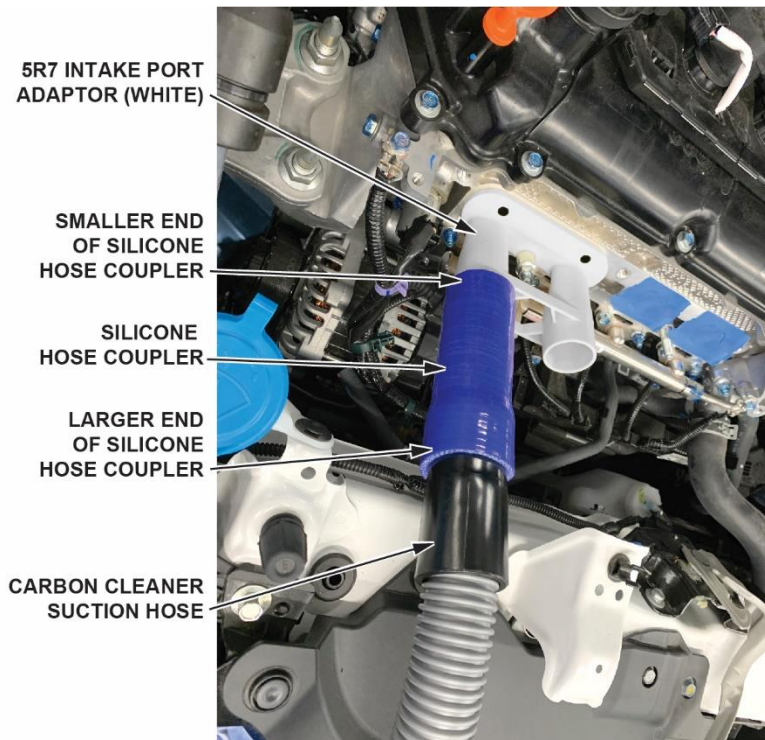

9. Confirm the air flow valve on the trigger is closed.

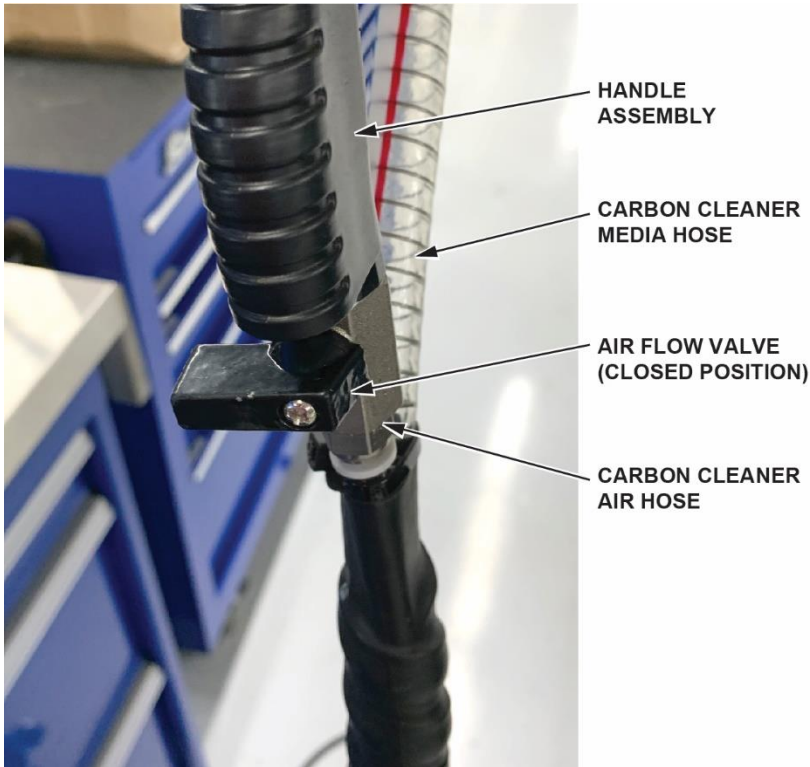

10. Connect a shop air supply hose to the air pressure regulator.

11. Make sure that the air pressure on the air valve gauge reads **80 psi** before use. To adjust the pressure, pull the pressure adjustment knob upward, and turn it clockwise or counterclockwise until the pressure is correct. Once it is correct, press it down to relock.

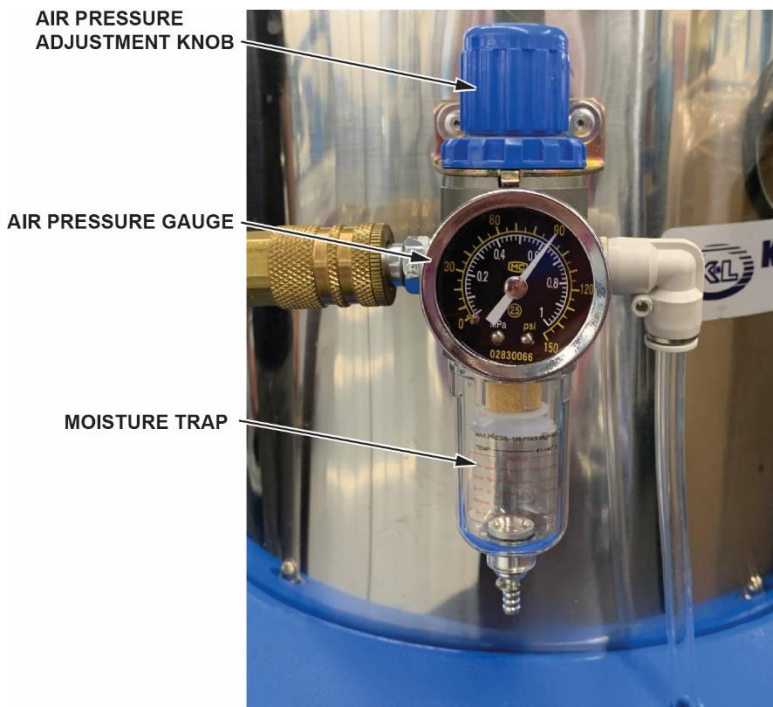

12. Turn the suction power switch on the front face to ON.

NOTE: If this switch is not ON while you are cleaning the ports, you may damage the valves.



13. Place the nozzle of the handle assembly in the opening of the intake port adaptor for cylinder #1. Make sure that the depth stopper is touching the intake port adaptor. Do not apply force onto the depth stopper when inserting the nozzle into intake port, as it will result in displacement of the depth stopper.

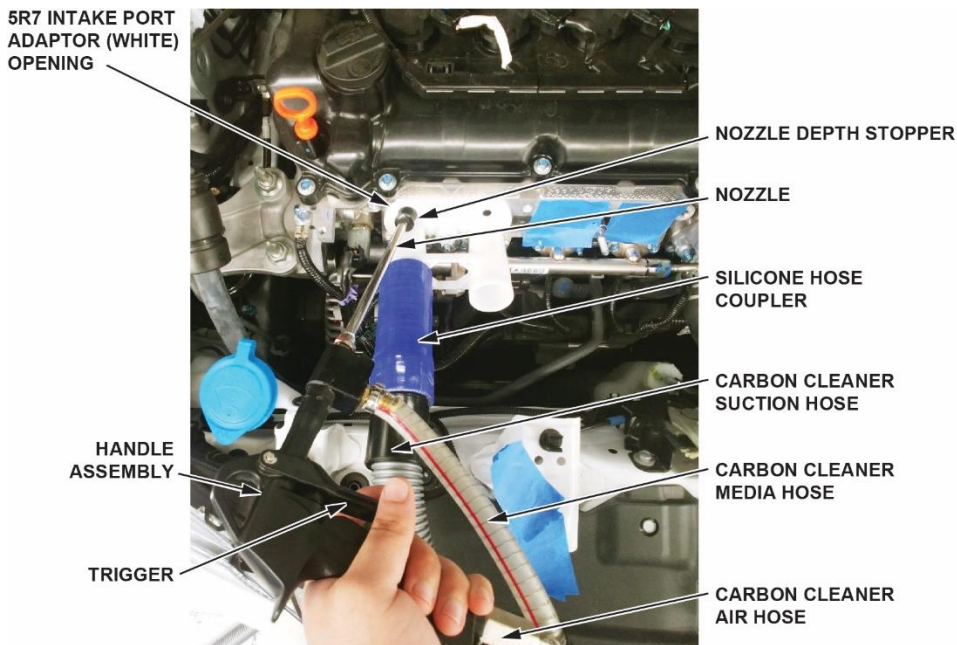

⚠ CAUTION

Damage to the surrounding area or injury to yourself may occur if the nozzle is removed from the intake port adaptor during the cleaning process. The media is applied with high pressure from the nozzle. Do not remove the nozzle during the cleaning process.

- Once the nozzle is in place, open the air flow valve on the handle so that it is vertical. Aim the nozzle at valve A and hold the trigger to start the cleaning process. Clean valve A for **2.5 minutes**. Then, aim the nozzle at valve B and repeat the process.

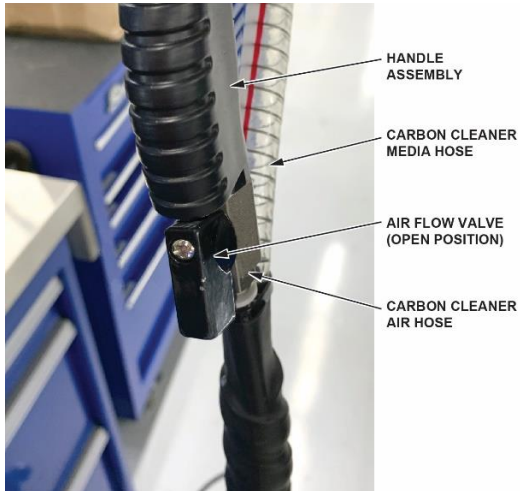

NOTE:

- When cleaning the valves, move the nozzle in an up and down motion to ensure a proper cleaning.
 - Do not insert the nozzle past the 80 mm depth stopper.
- Once you are done with cleaning both valves on a cylinder, switch the air flow valve to the closed position. Keep the suction on for **5 to 10 seconds** to extract any remaining media in that cylinder. Once completed with cylinder one, repeat steps 13 through 15 for cylinder two before proceeding to step 16.
 - Turn the suction power switch off, remove the adapter from cylinders #1 and #2 and confirm that the remaining media is removed. If media is still left, turn the suction power switch back on and apply the suction hose directly onto the cylinder head.

NOTE: Even after extracting the media in the area, there may be small amounts of media left. This is acceptable to leave.

GOOD



NO GOOD

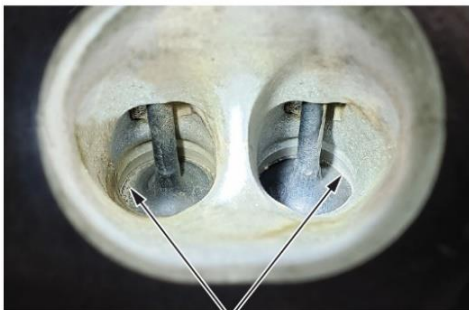

SMALL AMOUNTS OF MEDIA

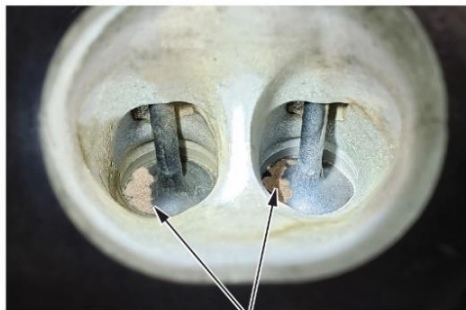

LARGE AMOUNTS OF MEDIA

17. Turn the crankshaft pulley clockwise 360 degrees. This will set it to TDC for cylinder #4. Remove the tape and confirm the intake valves for cylinders #3 and #4 are closed.
18. Tape off the intake ports on cylinders #1 and #2 to prevent debris from entering the ports.

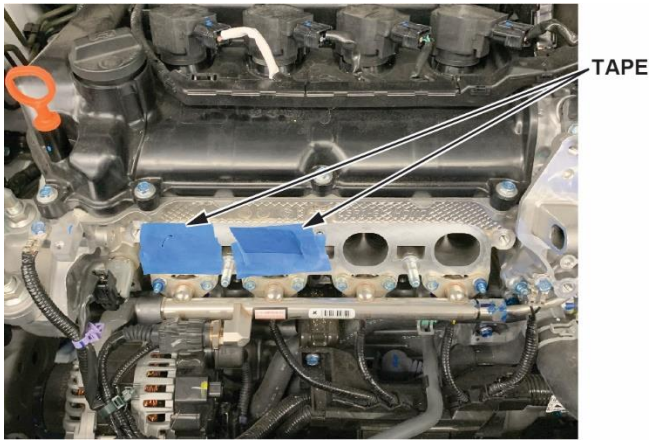

19. Repeat steps 7 through 16 for cylinders #3 and #4, then proceed to step 20.
20. Remove the tape.
21. Install all the removed parts in the reverse order of removal.
22. Once the repair is complete, empty the carbon cleaner tool of the used media.

NOTE:

- Do not reuse the used carbon cleaning media.
- Used media must be removed from the cleaning tool after each repair. (See page 15 for removal instructions.)
- Clear any DTCs

REMOVING THE USED CARBON CLEANER MEDIA

1. Remove the motor assembly off the base of the canister.
2. Inspect the condition of the filter for tears or clogs. Knock off any media that might be stuck on the filter by tapping it. If you notice a lack of performance from the motor assembly, replace the filter.
3. For removal of the old media, dump it out of the base of the canister. For any media in the hose, tilt the canister upside down at about 45 degrees so that media can flow out of the hose.

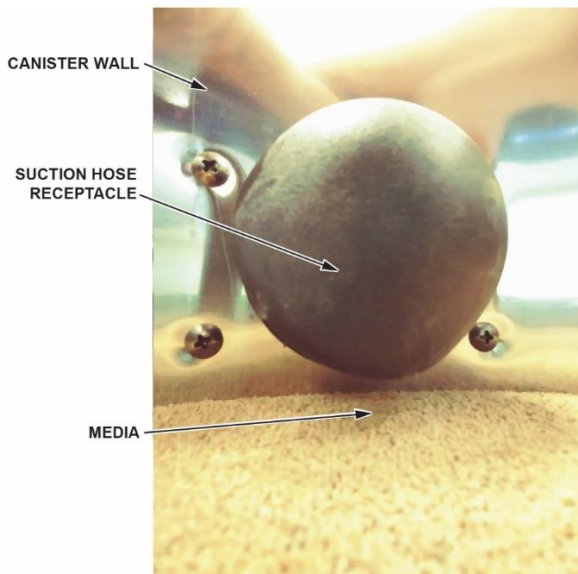

END