



Service Action

Code: 97FY

Subject	Volkswagen ID.4 Update Package															
Release Date	December 06, 2022															
Affected Vehicles	<p>Vehicles included in this service action are being released in preselected phases.</p> <ul style="list-style-type: none"> • The first group will be released and visible in ELSA in December 2022. Customer notification for the first group will take place in December 2022 as well. • Dealers will receive updates when future groups/waves are released and customer notifications are scheduled. • As always, dealers should ensure the service action shows OPEN in ELSA on the day of repair before performing any work under this service action. 															
	<table border="1"> <thead> <tr> <th>Country</th> <th>Beginning Model Year</th> <th>Ending Model Year</th> <th>Vehicle</th> <th>Vehicle Count</th> </tr> </thead> <tbody> <tr> <td>USA</td> <td>2021</td> <td>2021</td> <td>ID4</td> <td>21,156</td> </tr> <tr> <td>CAN</td> <td>2021</td> <td>2021</td> <td>ID4</td> <td>1,432</td> </tr> </tbody> </table>	Country	Beginning Model Year	Ending Model Year	Vehicle	Vehicle Count	USA	2021	2021	ID4	21,156	CAN	2021	2021	ID4	1,432
Country	Beginning Model Year	Ending Model Year	Vehicle	Vehicle Count												
USA	2021	2021	ID4	21,156												
CAN	2021	2021	ID4	1,432												
	<p>Check Campaigns/Actions screen in ELSA on the day of repair to verify that a VIN qualifies for repair under this action. ELSA is the <u>only</u> valid campaign inquiry & verification source.</p> <ul style="list-style-type: none"> ✓ Campaign status must show "open." ✓ If ELSA shows other open action(s), inform your customer so that the work can also be completed at the same time the vehicle is in the workshop for this campaign. 															
About This Service Action	Volkswagen is providing hardware and software updates to certain Volkswagen ID.4 vehicles produced within a specific time period. These updates include installing a more robust 12-volt battery, as well as software improvements and multiple security patches. An updated version of the owner's manual will also be provided.															
Code Visibility	On or about December 06, 2022, the campaign code will be applied to affected vehicles.															
Owner Notification	Owner notification will begin in December 2022.															
Campaign Expiration Date	This campaign expires on December 31, 2027 . Repairs must be performed on or before this date to be eligible for payment. Keep this expiration date in mind when scheduling customers for this action. If a customer wishes to have this service performed after the expiration date, your dealerships normal parts and labor cost associated with this repair will apply.															
Additional Information	<p>Please alert everyone in your dealership about this action, including Sales, Service, Parts and Accounting personnel. Contact Warranty if you have any questions.</p> <p>Dealers must ensure that every affected inventory vehicle has this campaign completed <u>before delivery to consumers</u>.</p> <p>Fill out and affix Campaign Completion Label (CAMP 010 000) after work is complete. <u>Labels can be ordered at no cost via the Compliance Label Ordering portal at www.vw.com</u>.</p>															

Parts Information

Parts Control Type: Free Order	Parts will be managed by Free Order
---	-------------------------------------

Initial Allocation: YES	Dealers will be sent an initial allocation prior to customer notification. If no initial allocation was received, please reference the Repair Projection Tool (below) to view your potential VIN population.
--	--

Repair Projection Tool: (right click to open)	
--	---

Criteria	Quantity	Part Number	P.O.C. Part Description	Ordering Method
01	1	000-915-105-FA DSP	12V Battery	POC Drop Ship

NOTE

Batteries have 15 month threshold to be used in vehicles. Please make sure you are using batteries in first in first out (FIFO) order, reducing the risk of obsolescence.

Interstate standard return process regarding expiration dates are to be used for this action.

NOTE

The specified part numbers reflect the status at the start of this action. Interim updates made in ETKA can cause a listed part number to become unavailable. In this case, the new part number specified in ETKA should be used.

Owner's Manual Ordering Information

Ordering Method: Technical Literature Ordering Center	Owner's manual kits can be ordered using the "Technical Literature Ordering Center" found on vw.hub.com (literature.vw.com).
--	--

Initial Allocation: YES	<u>IMPORTANT:</u> Dealers were sent an initial allocation prior to customer notification. The allocation included a delivery of owner's manuals and a separate delivery of tow hook supplements. If additional quantities are needed, please order the part numbers listed below.
--	---

Criteria	Quantity	Part Number	Description
02 and 05	1	11A012723SG	US English Kit (US English owner's manual + English tow hook supplement)
03 and 05	1	11A012722DG	CAN English Kit (CAN English owner's manual + English tow hook supplement)
04 and 06	1	11A012742DG	CAN French Kit (CAN French owner's manual + French tow hook supplement)

The information in this document is intended for use only by skilled technicians who have the proper tools, equipment and training to correctly and safely maintain your vehicle. These procedures are not intended to be attempted by "do-it-yourselfers," and you should not assume this document applies to your vehicle, or that your vehicle has the condition described. To determine whether this information applies, contact an authorized Volkswagen dealer. ©2022 Volkswagen Group of America, Inc. and Volkswagen Canada. All Rights Reserved.

Claim Entry Instructions

The labor times listed here may differ from the labor operations and labor times listed in ELSA.

After campaign has been completed, enter claim as soon as possible to help prevent work from being duplicated elsewhere. Attach the ELSA screen print showing action open on the day of repair to the repair order.

If customer refused campaign work:

- ✓ U.S. dealers: Submit request via WISE under the *Campaigns/Update/Recall Closure* option.
- ✓ Canada dealers: Upload the repair order [signed by customer] to Volkswagen WIN/Operations/Campaign Closure.

Service Number	97FY		
Damage Code	0099		
Parts Vendor Code	WWO		
Claim Type	Sold vehicle: 7 10 Unsold vehicle: 7 90		
Causal Indicator	Mark BATTERY* as causal part		
Vehicle Wash	Do not claim wash under this action		
Vehicle Loaner (USA ONLY)	See special claiming instructions for rental/loaner claiming. NOTE: A 2nd claim must be entered for rental/loaner claiming		
Vehicle Loaner (Canada ONLY)	Loaner/rental coverage cannot be claimed under this action. Please refer to the Volkswagen Service Loaner Program to determine loaner eligibility.		
Vehicles may have more than one criteria. Complete and claim all applicable criteria on <u>one</u> claim.			
Criteria I.D.	01		
	Update software. Replace 12V battery.		
	LABOR		
	Labor Op	Time Units	Description
	2706 89 50	10	Connect battery charger
	9710 25 99	60	Update ICAS3 with USB
	2706 01 99	10	Check 12V battery
	2706 55 99	60	Replace 12V battery
	2706 89 99	10	Charge 12V battery (if necessary)
	0150 00 00	Time stated on diagnostic protocol(s)	Perform software update SVM, software configuration SVM and complete all necessary GFF test plans
	<i>(NOTE: multiple GFF logs can be added together)</i>		
	2706 02 99	25 TU per bus sleep	Perform up to four bus sleep procedures

Continued on next page

	PARTS		
	Quantity	Part Number	Description
	1.00	000915105FADSP	BATTERY*

Criteria I.D.	02 or 03 or 04 (owner's manual) -AND- 05 or 06 (owner's manual supplement)
	NOTE: All owner's manual kits include the necessary owner's manuals <u>and</u> the owner's manual supplement.

	Provide owner's manual kit.
--	-----------------------------

OUTSIDE MATERIAL					
Crit.	Qty	Part Number	Description	Amount	
02	1	11A012723SG	USEGLISHKIT	\$7.76 (USD)	
03	1	11A012722DG	CANGLISHKIT	\$16.97 (USD) \$22.90 (CAN)	
04	1	11A012742DG	CANFRENCHKIT	\$29.73 (USD) \$40.13 (CAN)	

Vehicle Loaner (USA ONLY)	Enter vehicle loaner claim as a separate (2nd) claim		
	Allowed time = up to 2 days		

	Claim Type	1 SP	
	Service Number	X182	
	Damage Code	0055	
	Damage Location	Blank	
	Parts Vendor Code	K21	
	Outside Labor Operation	X182US00 (mark as causal)	Enter dollar amount on rental/loaner invoice (Up to \$53 per day)

Customer Letter Example (USA)

<MONTH YEAR>

<CUSTOMER NAME>

<CUSTOMER ADDRESS>

<CUSTOMER CITY STATE ZIPCODE>

This notice applies to your vehicle: <MODEL YEAR> <BRAND> <CARLINE>, <VIN>

Subject: Service Action 97FY – Volkswagen ID.4 Update Package

Dear Volkswagen Owner,

As part of Volkswagen's ongoing commitment to customer satisfaction, we are informing you of our decision to conduct a service action on certain 2021 model year Volkswagen ID.4 vehicles. Our records show that you are the owner of a vehicle affected by this action.

About this Service Action:

Volkswagen is providing hardware and software updates to certain Volkswagen ID.4 vehicles produced within a specific time period. These updates include installing a more robust 12-volt battery, as well as software improvements and multiple security patches. An updated version of the owner's manual will also be provided.

What will we do?

Your authorized Volkswagen dealer will perform this update package for you free of charge. This work will take at least one day to complete. Please keep in mind that your dealer may need additional time for the preparation of the work, as well as to accommodate their daily workshop schedule.

What should you do?

Please contact your authorized Volkswagen dealer as soon as possible to schedule this work. To set up an appointment online, please visit www.vw.com/find-a-dealer.

This service action will be available for you **free of charge only until December 31, 2027**. If you wish to have this work performed after that date, your dealer's normal costs associated with this work will apply.

Lease vehicles and address changes

If you are the lessor and registered owner of the vehicle identified in this action, please forward this letter immediately via first-class mail to the lessee within ten (10) days of receipt. If you have changed your address or sold the vehicle, please fill out the enclosed prepaid Owner Reply card and mail it to us so we can update our records.

Can we assist you further?

If your authorized Volkswagen dealer fails or is unable to complete this work free of charge within a reasonable time, or if you should have any questions about this communication, please reach out to us using your preferred method of communication at www.vw.com/contact or by calling us at 800-893-5298.

Checking your vehicle for open Recalls and Service Campaigns

To check your vehicle's eligibility for repair under this or any other recall/service campaign, please visit www.vw.com/owners/recalls and enter your Vehicle Identification Number (VIN) into the Recall/Service Campaign Lookup tool.

We apologize for any inconvenience this matter may cause; however we are taking this action to help ensure your vehicle continues to meet and exceed your expectations.

Sincerely,

Volkswagen Customer Protection

Customer Letter Example (Canada)

<MONTH YEAR>

<CUSTOMER NAME>

<CUSTOMER ADDRESS>

<CUSTOMER CITY STATE ZIPCODE>

This notice applies to your vehicle: <MODEL YEAR> <BRAND> <CARLINE>, <VIN>

Subject: Service Action 97FY – Volkswagen ID.4 Update Package

Dear Volkswagen Owner,

As part of Volkswagen's ongoing commitment to customer satisfaction, we are informing you of our decision to conduct a service action on certain 2021 model year Volkswagen ID.4 vehicles. Our records show that you are the owner of a vehicle affected by this action.

About this Service Action:

Volkswagen is providing hardware and software updates to certain Volkswagen ID.4 vehicles produced within a specific time period. These updates include installing a more robust 12-volt battery, as well as software improvements and multiple security patches. An updated version of the owner's manual will also be provided.

What will we do?

Your authorized Volkswagen dealer will perform this update package for you free of charge. This work will take at least one day to complete. Please keep in mind that your dealer may need additional time for the preparation of the work, as well as to accommodate their daily workshop schedule.

What should you do?

Please contact your authorized Volkswagen dealer as soon as possible to schedule this work. To set up an appointment online, please visit www.vw.com/find-a-dealer.

This service action will be available for you free of charge only until December 31, 2027. If you wish to have this work performed after that date, your dealer's normal costs associated with this work will apply.

Lease vehicles and address changes

If you are the lessor and registered owner of the vehicle identified in this action, please forward this letter immediately via first-class mail to the lessee within ten (10) days of receipt. If you have changed your address or sold the vehicle, please fill out the enclosed prepaid Owner Reply card and mail it to us so we can update our records.

Can we assist you further?

If your authorized Volkswagen dealer fails or is unable to complete this work free of charge within a reasonable time, please contact Customer Relations, Monday through Friday from 8AM to 8PM EST by phone at 1-800-822-8987 or via our "Contact Us" page at www.vw.ca.

We apologize for any inconvenience this matter may cause; however we are taking this action to help ensure your vehicle continues to meet and exceed your expectations.

Sincerely,

Volkswagen Customer Protection

Repair Overview



NOTE

A checklist is included at the end of this document, in one of the attachment tabs in ELSA and on ServiceNet.

The checklist can be printed and used to guide the technician through all of the repair steps.

Appendix A includes the software table and will show what the updated software versions should be after completing this repair in its entirety.

1. USB Flash of ICAS3
2. Replace 12V battery
3. Execute measure code US30
4. Perform bus sleep procedure
5. Execute measure code US31
6. Execute GFF program "Replace 12V battery"
7. Perform bus sleep procedure
8. Execute GFF program "Learn VKMS"
9. Perform manual basic settings
10. Adjust service interval display
11. Execute all GFF programs listed in the test plan
12. Replace owner's manual literature

CRITICAL REPAIR STEP

STOP! STOP!

This software update must be performed **BEFORE** completing the reset of the balancing time counters outlined in Safety Recall 9302.

NOTE

- These repair instructions may differ from the labor operations and labor times listed in ELSA.
- Damages resulting from improper repair or failure to follow these work instructions are the dealer's responsibility and are not eligible for reimbursement under this action.
- This procedure must be read in its entirety prior to performing the repair.
- Due to variations in vehicle equipment and options, the steps/illustrations in this work procedure may not identically match all affected vehicles.
- Diagnosis and repair of pre-existing conditions in the vehicle are not covered under this action.
- When working during extreme temperatures, it is recommended that the vehicle be allowed to acclimate inside the shop to avoid temperature-related component damage/breakage.

Required Tools



Battery Tester/Charger
-VAS5908-



Diagnostics Interface
W-LAN
-VAS6154A-



Diagnostic Tester
-VAS6150D (or higher)-



USB Module
-VAS6154/4A-
(included with -VAS6154A-)

Required USB Drive

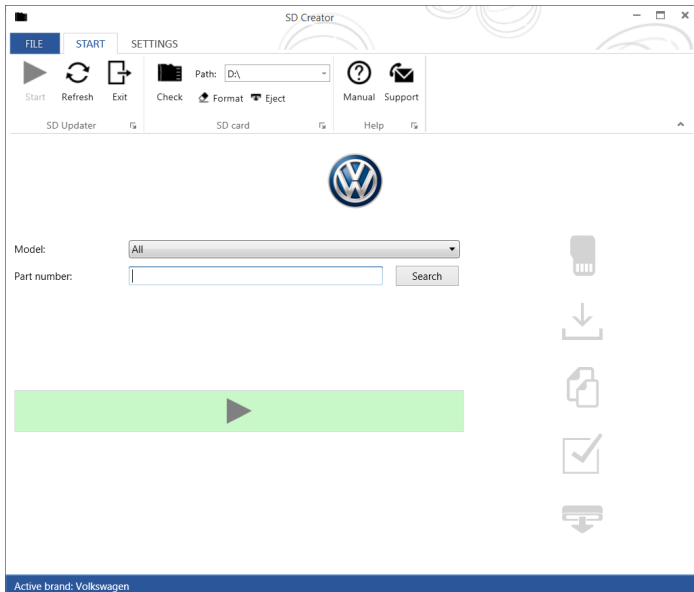

- The required software will have to be downloaded onto a USB (or USB-C) drive using the SD Creator program
- **Reference the latest version of TSB 2054866 for additional information on the use of the SD Creator program.**
- **Use a 32 GB USB stick.**

NOTE

- The required USB drives cannot be ordered via the parts ordering system, they must be created using the SD Creator program.
- The required USB drive is a servicing material. Therefore the cost of the USB drive will not be reimbursed.
- The USB drive can be used for future software updates.

NOTE

If the search for the software part number returns no result, check if the certificate is valid.

Go to Settings and select the current, valid certificate used in ODIS.

Software Part Number

3G0.919.360.RK

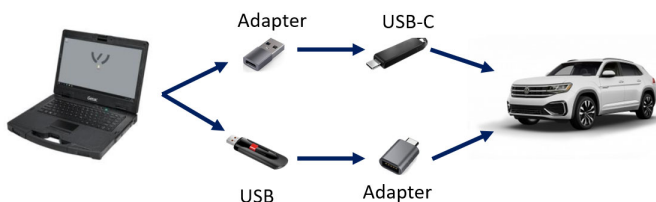

General information for creating the USB stick:

- The Infotainment system uses a USB-C input.
- If the software is downloaded onto a USB drive, a USB to USB-C adapter will be required.
- If the software is downloaded onto a USB-C drive, a USB-C to USB adapter will be required since the VAS tester does not have a USB-C drive.
- **Use a 32 GB USB stick.**
- USB type C (at least USB 2.0), reading/writing speed: at least 40 MB/s / 10 MB/s.
- USB type A including type C (at least USB 2.0), reading/writing speed: at least 40 MB/s / 10 MB/s.
- Do not use a USB hub (USB distributor to use several USB devices on one USB port) to install the software update.

Repair Instruction

Section A - Check for Previous Repair

TIP

If Campaign Completion label is present, no further work is required.

Applicable criteria ID(s)	Campaign/Action Status
01 ← 2	Open ← 1

EXAMPLE

Campaign/Action	Start	Designation
→ 3	2015-11-10	W-SERV_ACT -
	2018-12-13	RECALL -
	2017-05-16	A-RECALL -

EXAMPLE

- Enter the VIN in Elsa and proceed to the “Campaign/Action” screen.

TIP

On the date of repair, print this screen and keep a copy with the repair order.

- Confirm the Campaign/Action is open <arrow 1>. If the status is closed, no further work is required.
- Note the Applicable Criteria ID <arrow 2> for use in determining the correct work to be done and corresponding parts associated.

CRITICAL REPAIR STEP



If multiple software update Campaign/Actions are open, they must be performed in order of the Start date <arrow 3>. The oldest should be performed first.

- **This software update must be performed before completing Safety Recall 9302.**
- **Proceed to Section B**

Section B – Repair Prerequisites

NOTE

Prior to launching the VAS Diagnostic Tester and starting an update, ensure the following conditions are met;

- ✓ **The ODIS software is completely up to date.**
 - Refer to the “Alerts” section on ServiceNet home page for the current ODIS version.
- ✓ **The battery charger is connected to the vehicle battery and remains connected for the duration of the software update.**
 - Battery voltage must remain above 12.5 volts for the duration of the software update. Failure to do so may cause the update to fail, which could result in damage to the control module. Control modules damaged by insufficient voltage will not be covered.
- ✓ **The screen saver and power saving settings are off.**
 - Failure to do so may result in the tester entering power save mode during the software update, which could result in damage to the control module.
- ✓ **The VAS Diagnostic Tester is plugged in using the supplied power adapters.**
 - Under no circumstances should the tester be used on battery power alone during the software update. Failure to do so may result in the tester powering off during the update, which could result in damage to the control module.
- ✓ **The VAS Diagnostics Interface MUST ONLY be connected to the tester with a USB cable.**
 - Performing a software update using a Bluetooth or WiFi connection increases the risk of losing connection during the update, which could result in damage to the control module. It also greatly increases the time required to perform the update. Requests for additional time or parts will be denied if the GFF log shows the update was performed using Bluetooth or WiFi.

WARNING

Radiator Fan(s) may cycle ON high speed during the Update Process! There is a serious risk that personal injury may result if contact is made with spinning fan blades. Keep hands and all objects away from Radiator Fan(s) during Update Process!

TIP

To Update-Programming using SVM, review and follow instructions in Technical Bulletin 2014603: *Software Version Management (SVM) Operating Instructions*.

The SVM Process must be completed in its entirety so the database receives the update confirmation response. A warranty claim may not be reimbursed if there is no confirmation response to support the claim.

NOTE

- Damages resulting from improper repair or failure to follow these work instructions are the dealer's responsibility and are not eligible for reimbursement under this action.
- Diagnosis and repair of pre-existing conditions in the vehicle are not covered under this action.

NOTE

- All campaign software updates should be completed during a single, standalone ODIS Diagnostic Session. You must fully complete this campaign and send all logs before beginning any other campaigns or operations.
- If there are any ODIS "Hot-Fix" patches installed, they must be removed from the scan tool before beginning this operation. ODIS "Hot-Fix" patches may affect the update process.

Before starting the software update, the following conditions must be met:

- USB drive created using SD Creator (see above instructions).
- ODIS Service version MUST be at **V10.0.0** – Diagnostic Content **2.46.5** or higher. Older versions will result in a much longer software flash time. Requests for additional time due to longer flash times when using older ODIS versions will be denied.
- ODIS Feedback must be set up correctly:
 - See communication: Offboard Diagnostic Information System Service (ODIS Service), Number: **VOS-22-06** / Subject: Dedicated Email Server Configuration & Feedback Settings / Date: Feb. 1, 2022
- Dealership's internet firewall settings must meet the specified requirements.
 - See communication: Diagnostic Device Hardware & Windows®, Number: **VHW-22-11** / Subject: VAS Diagnostic Device Firewall Settings / Date: July 27, 2022
- ODIS user must have SFD access.
 - See communication: Offboard Diagnostic Information System Service (ODIS Service), Number: **VOS-21-08** / Subject: ODIS Login – SFD Functions / Date: Mar. 11, 2021
- Windows Power Options must be set according to the ODIS tester setup directions:
 - See communication: Diagnostic Device Hardware & Windows®, Number: **VHW-22-13** / Subject: Change Power Options in Windows® 10 / Date: Nov. 1, 2022
 - The "Device Power Management" sections from the VAS 6150X Diagnostic Laptop – Unpacking and Setup Instructions can also be referenced.
- Only one key can be in the vehicle when performing this software flash.
- The vehicle key's battery must be ok.
- Any additional keys must be a minimum of 20 meters away from the vehicle.
- The car MUST NOT be hooked up to a high-voltage charger.
- The 12V battery to be installed in the vehicle must have sufficient charge (see Step 2 for further information).
- This work will take 7 hours or more.
- If the work steps have to be interrupted for any reason, the best stopping point is at one of the bus sleep steps.



CRITICAL REPAIR STEP

 **STOP!** 

Before starting programming, it is essential to perform the following actions for the -VAS5908- battery charger.

The battery charger's default setting will switch the charger off automatically after a period of time. To prevent this, the following must be carried out.

Switch it OFF and then ON again each time the charger is connected.

The battery charger's display must have switched off before it's restarted.

The charging time can be changed in the charger's settings menu (access code = 6161). Refer to the owner's manual for further information. **DO NOT** change any settings that will damage the charger or the vehicle.

- Connect battery charger -VAS5908-.
- When connecting the charger to the battery, connect the positive cable to the positive charging terminal for the battery and connect the negative cable to the grounding lug on the chassis. **DO NOT** connect the ground cable directly to negative terminal of the battery.

NOTE

If the customer is enrolled in CarNet and they have the app downloaded on their phone, they may receive several notifications during the update process.

CRITICAL REPAIR STEP

 **STOP!** 

- Check for pre-existing faults.
- If any of the modules being updated are offline, the communication issue must be addressed prior to starting this procedure. See Appendix A for software table.
- Any module with a "Faulty Control Module" fault *that cannot be cleared*, must be addressed prior to starting the flash. The flash may fail for the affected control module.
- Diagnosis and repair of pre-existing conditions are not covered under this action.

NOTE

- The service interval display may be reset by the software configuration. The current service interval must be read out first and rechecked in Step 10 *after* the software updates are complete.
- It is also possible that the service interval could be reset on a previous service visit if a software configuration was carried out on the vehicle. Therefore, the service interval should be compared to the vehicle's service records. If there is a discrepancy, the service interval values will have to be adjusted accordingly.
- After the software updates are complete, the adaptation channels will also change:
 - Pre-flash:
 - \$0541 (distance driven since the last inspection AND time since the last inspection)
 - Post-flash:
 - \$0548 (distance driven since the last inspection)
 - \$0549 (time since the last inspection)

- Using Operating mode "OBD", check and record the 005F adaptation channel \$0541 for the current service interval.

Control modules Results

005F - Information electronics 1 (UDS / ISOTP / 10A035842E / 0792 / H20 / EV_MUICASSAFEPart / 001001) DTC memory

Adaptation/parameter	RDID	Current value	Entry	Unit
[VO]_service_intervall	\$0541			
Inspection, distance until next inspection		16,090		km
Inspection, distance driven since the last inspection		2,000		km
Inspection, time until next inspection		365		d
Inspection, time since the last inspection		51		d

Filter:

Apply Restore Reset all

005F - ANP

Step 1 – USB Flash of ICAS3 (approximate time = 35 minutes)

- Ensure the battery charger is connected.
- Ensure there is nothing connected to the OBD diagnosis connection.

! NOTE

The ignition must remain on during the entire flashing process.

- **The hazards must remain on.**
- **The driver door must remain open.**
- **Buckle the seat belt into the driver seat belt buckle.**

! NOTE

Observe the ignition status often. Even with the door open, seat belt buckled and hazards on, it may be possible that the ignition turns off on its own. If this occurs, turn the ignition back on and the update should continue.



- Place the vehicle key over the reader coil in the center console cupholder.
- Any additional keys must be a minimum of 20 meters away from the vehicle.



- Insert the USB drive into one of the USB ports.
- Turn the ignition ON.

NOTE

The radio display may display “No playable content” when the ignition is turned on. This is normal. DO NOT remove the USB drive from the USB port.



- The update will start on its own after about two minutes.
- During the update, the instrument cluster display will change multiple times.

NOTE

Observe the ignition status often. Even with the door open, seat belt buckled and hazards on, it may be possible that the ignition turns off on its own.



NOTE

If update does not start after five minutes, turn ignition off, remove USB and restart from the beginning.

Unless an error has occurred, the USB should never be removed from the USB port while the software update is in progress.

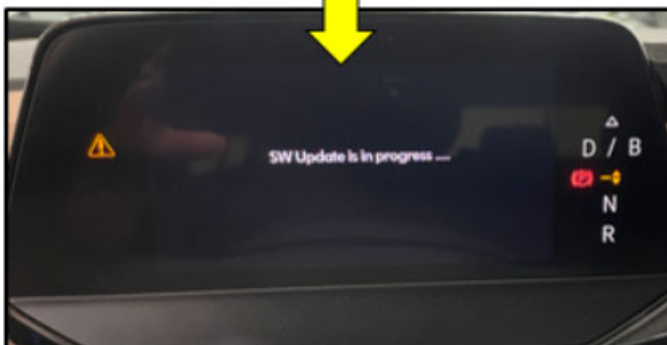

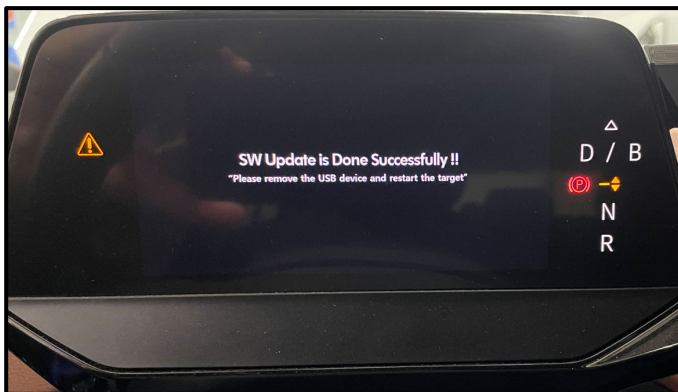
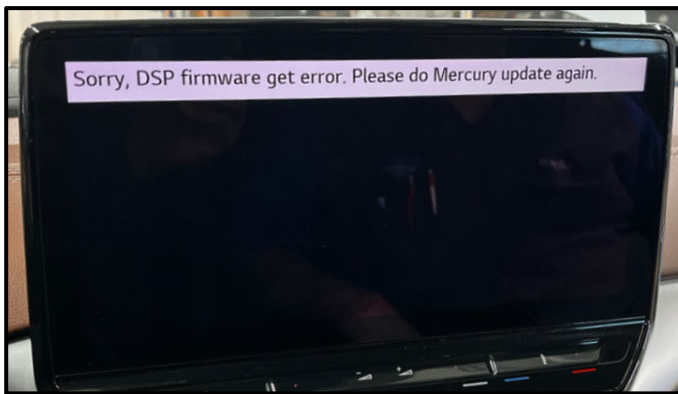

NOTE

If **“Updating CPU...”** message appears for longer than 40 minutes, or if any other error message occurs, restart the update:

Turn off ignition

Remove USB

Reset ICAS3:

- Open driver door
- Remove fuse SC30 for at least 10 seconds, reinstall fuse and reattempt update from the beginning.

If the update still does not complete, recreate the USB using the SD Creator and restart from the beginning.

- The software update is complete when the message shown appears.
- Turn the ignition OFF.
- Once the update is complete, remove the USB drive from the USB port.

NOTE

The successful update message may remain, even if the ignition is switched OFF and back ON.

NOTE

The instrument cluster may remain off, even though the update is complete. If the cluster is off after 40 minutes, cycle the ignition off and back on. The successful message should now appear.

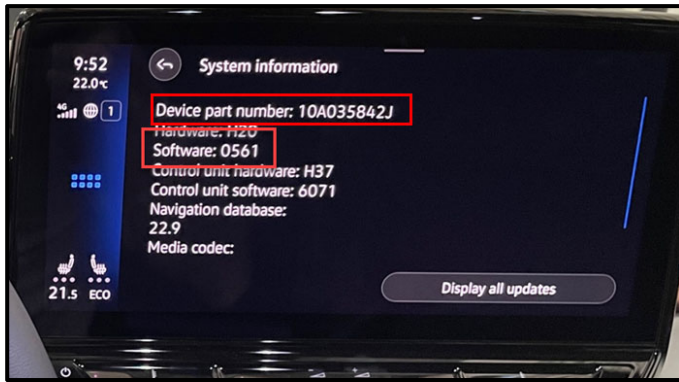

- Check SW version on infotainment display.

NOTE

If SW version did not update to 0561, or if the Device part number did not change to 10A035842J:

Turn off ignition

Remove USB

Reset ICAS3:

- Open driver door
- Remove fuse SC30 for at least 10 seconds, reinstall fuse and reattempt update from the beginning.

If the update still does not complete, recreate the USB using the SD Creator and restart from the beginning.

NOTE

If a diagnostic session was started, address 005F and address 8125 must be re-identified before performing the software update in Step 3.

Failure to do so can result in error code ERP0215E when the SVM is attempted in Step 3.

Proceed to Step 2 for replacing the 12V battery.

Step 2 – Replacing 12V Battery

WARNING

Leaking battery acid.

Risk of acidic chemical burns on the body and corrosion on the vehicle.

- Wear protective gloves, clothing and eyewear.
- The battery must not be tilted.
- Neutralize sulfuric acid as fast as possible for example using soapy water.

WARNING

Oxyhydrogen gas escaping due to charging and degassing.

Risk of explosion

- Prevent generating sparks.
- Take care to avoid short circuits.
- No open fire.
- Do not smoke.
- No open flames.
- Discharge the static electricity, quickly touch the door striker.
- Only perform battery procedures in well-ventilated locations.
- Pay attention to the correct side of the bleed hole.

WARNING

Danger of explosion when checking, charging or jump starting the battery.

- Do not check or charge a battery when the “ALI (Acid Level Indicator)” has no color or is bright yellow. Do not give a jump start.

⚠ CRITICAL REPAIR STEP

STOP STOP

Before replacing the 12V battery

There is a possibility that the 12V on-board electrical system will continue to be supplied with power by the HV battery and DC/DC converter if the brake pedal is not pressed. When the brake pedal is pressed, the contactors of the HV battery are opened.

Briefly press the brake pedal.

Wait two minutes before starting the 12V battery replacement.

Ensure the ignition is off before replacing the 12V battery.

- Unfortunately, in individual cases there is the possibility that in preparation for this service campaign there may have been an above average storage of the 12V battery and, as a result, a sufficient charge level can no longer be ensured.
- Therefore, with sufficient time before starting an update, check the charge level of the battery to be fitted using no-load voltage measurement.
- If the voltage is greater than or equal to 12.5V, then the charge of the battery that took place during the update is sufficient.
- If the voltage is between 12.3V and 12.5V then the battery must be charged for at least 6 hours in advance. If the voltage is less than 12.3V, check the battery with the battery tester VAS 6161 and proceed according to the specification of the tester.

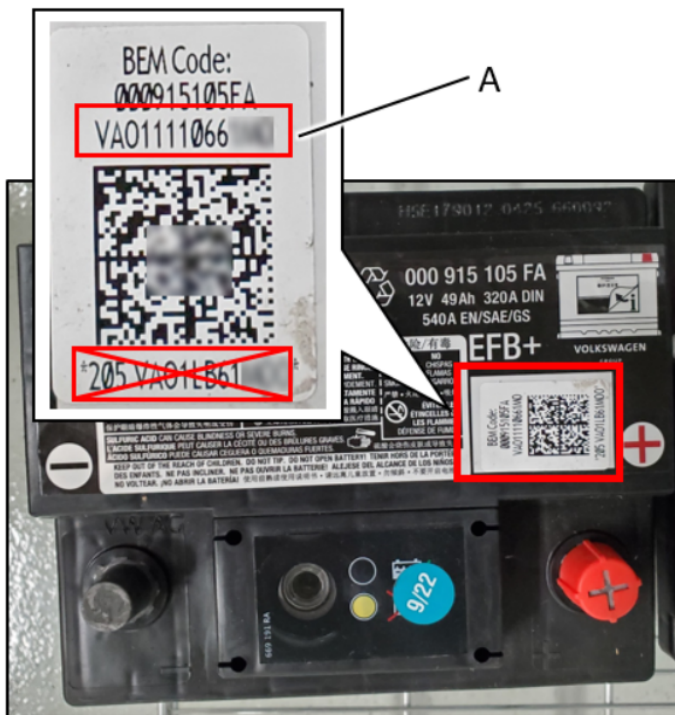

Part Number	Part Description
000-915-105-FA DSP	12 Volt Battery

- Before installing the 12V battery, record the following from both the NEW and the OLD 12V batteries:
 - Serial number <A>
 - Battery capacity
 - Battery manufacturer
- This will be required later when performing the 12V battery replacement test plan.

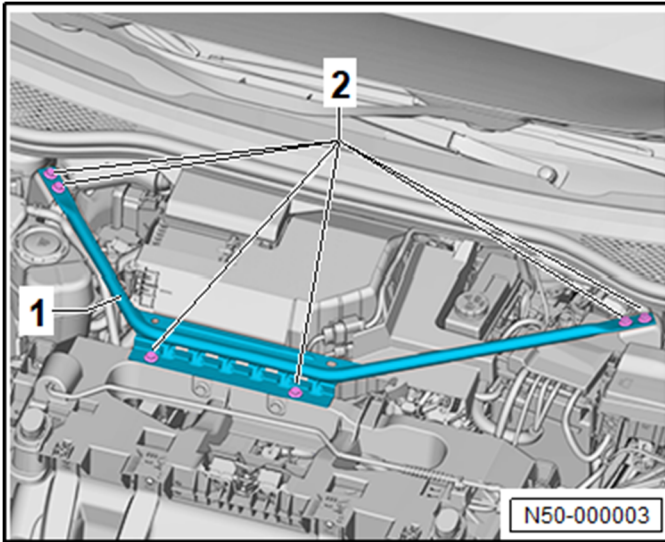

- Remove the bolts <2>.
- Remove the impact member <1>.

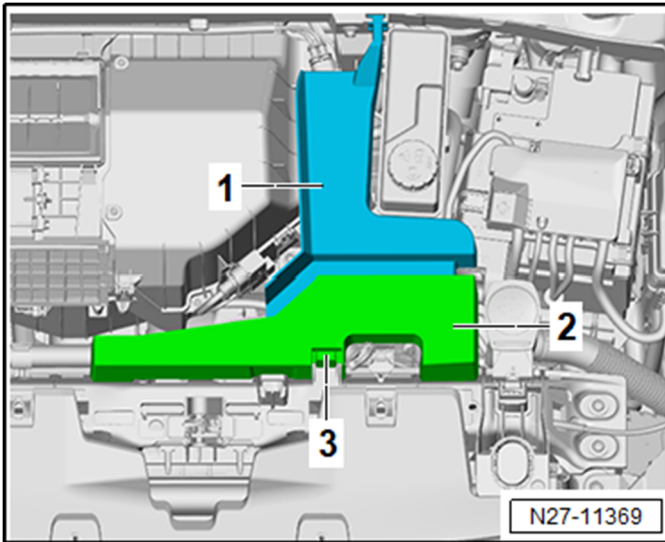

- Release the hook <3>.
- Remove the high-voltage connection cover <2>.

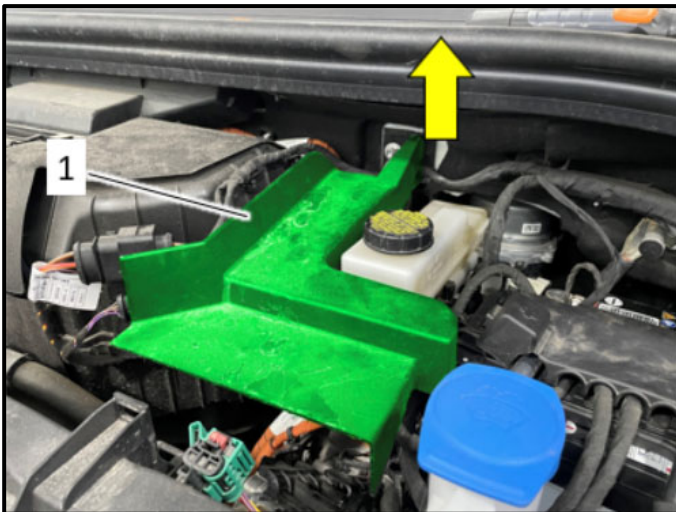

- When removing the high-voltage connection cover <1> the cover has to be lifted up at the connection to the firewall in the <direction of arrow>.

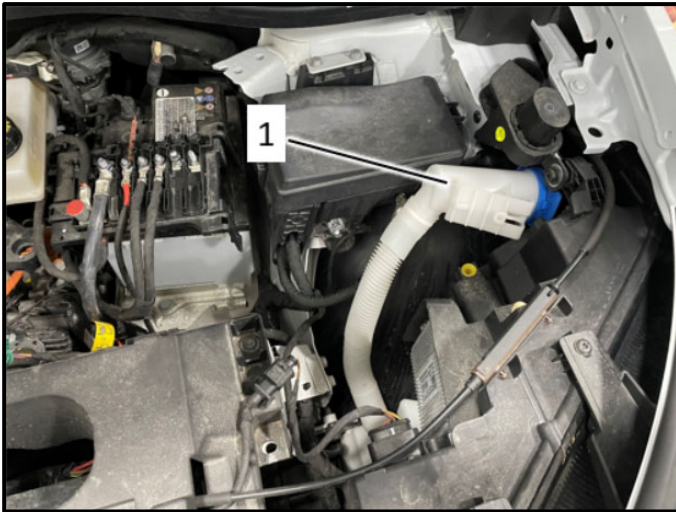

- The washer fluid filler neck will have to be unclipped and moved to the side.

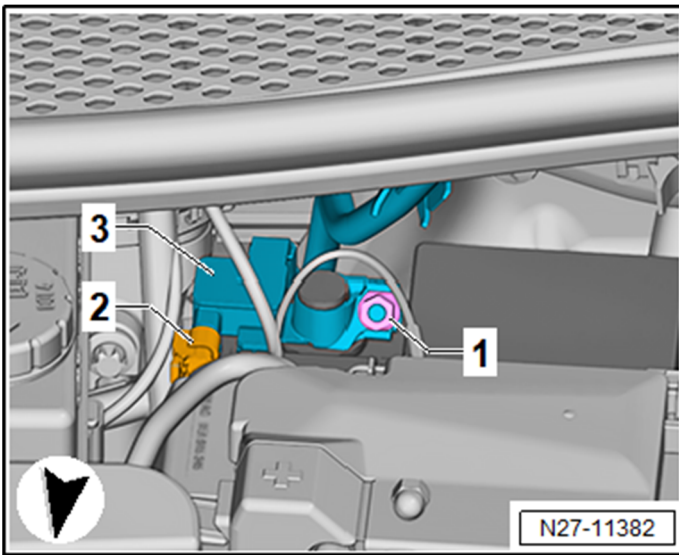

- Open the negative terminal cover above the battery monitoring control module <3>.
- Loosen the nut <1> several turns and remove the battery monitoring control module <3> from the battery negative terminal.
- Disconnect the connector <2> from the Battery Monitoring Control Module -J367-.
- Wait 1 minute.
- Check the voltage of the 12V vehicle electrical system using a commercially available voltmeter.
- The voltage must be 0V.

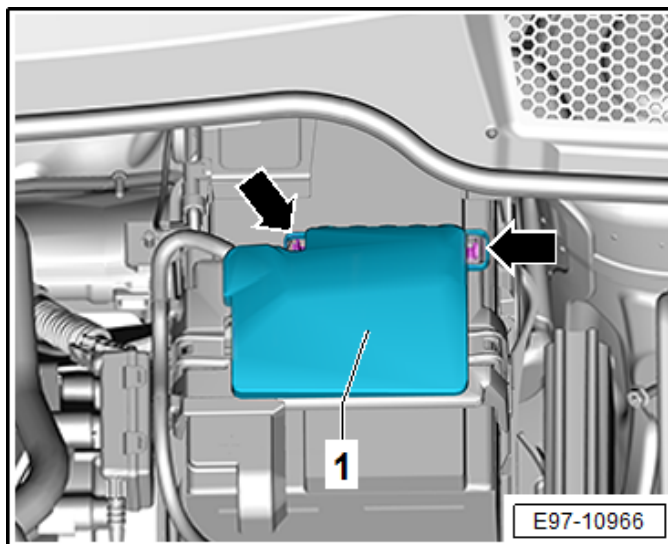

- Release the hooks <arrows>.
- Remove the cover <1>.

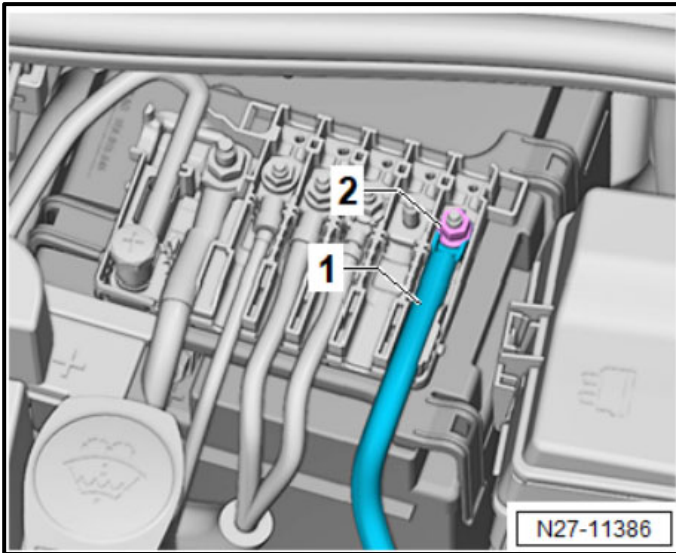

- Loosen the nut <2>.
- Remove the wire <1>.

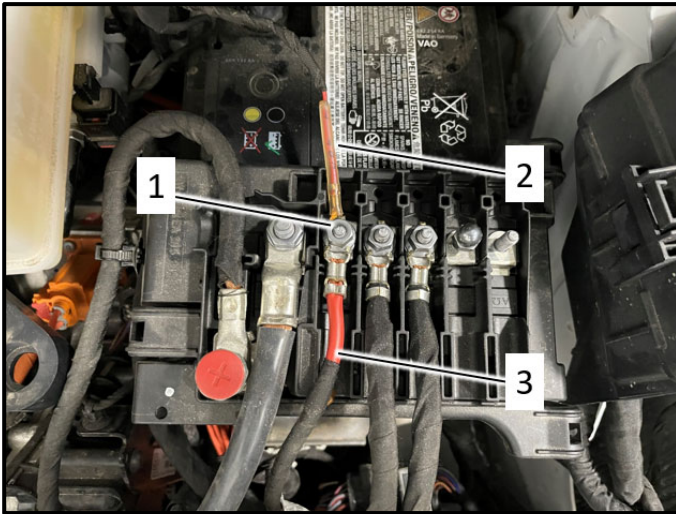

- Loosen the nut <1>.
- Remove wires <2> and <3>.

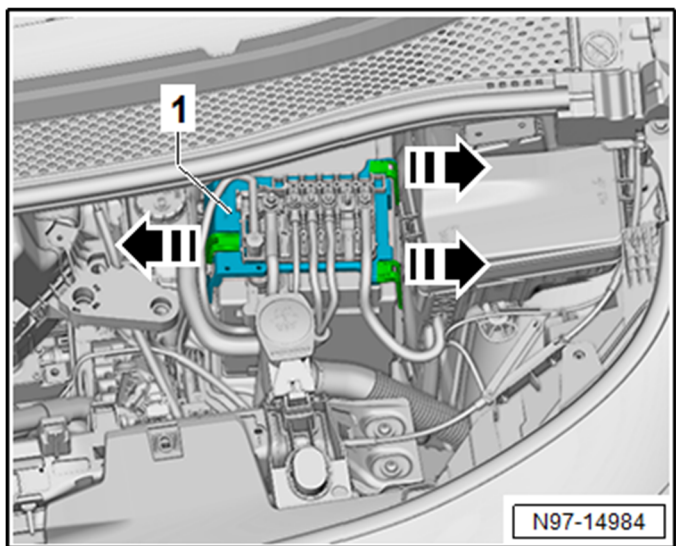

- Release the retaining straps for the bracket for fuse panel A <1> in the direction of <arrow>.
- Remove the bracket for fuse panel A <1> and move it to the side with the wires still connected.

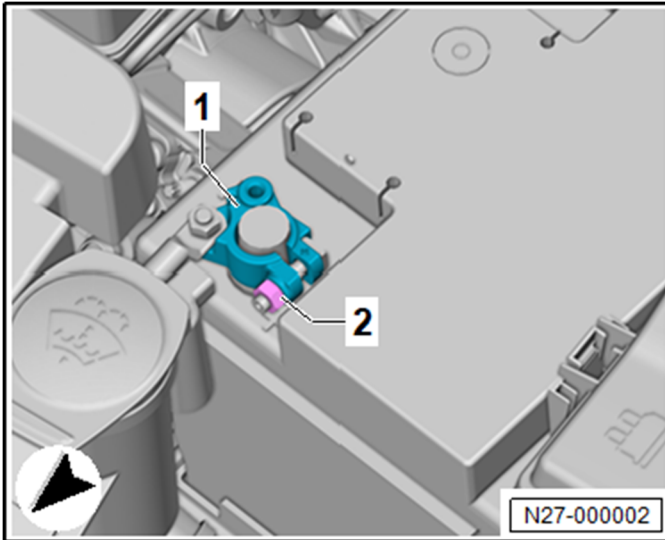

- Loosen the nut <2> several turns and remove the positive terminal battery clamp <1>.

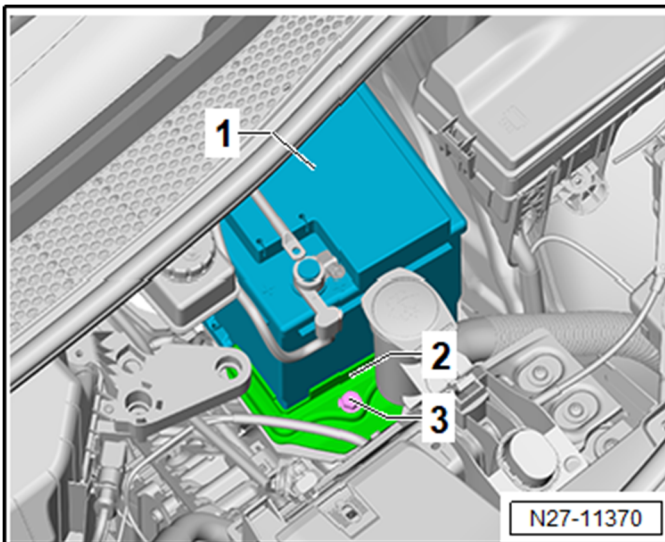

- Remove the bolt <3>.
- Remove the bracket <2>.
- Remove the battery <1> in the direction of travel from the battery tray and lift it upward out of the engine compartment.
- Install the new battery in the reverse order of removal.

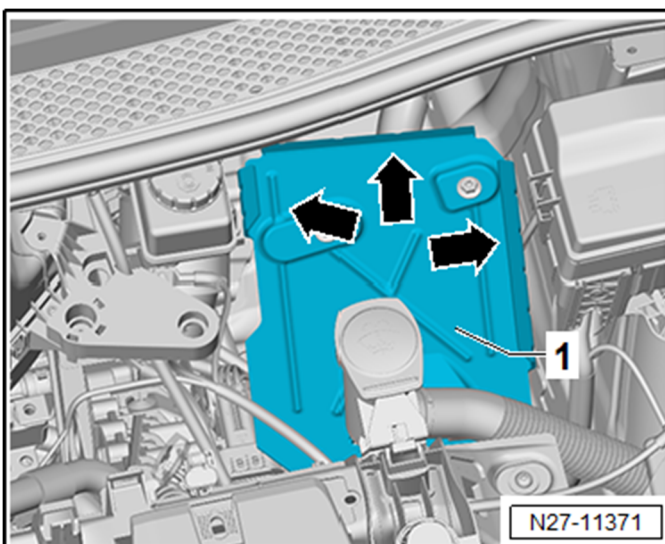

- Insert the battery into the battery tray <1> so that the battery clamping strip touches the rear and side stops <arrows>.

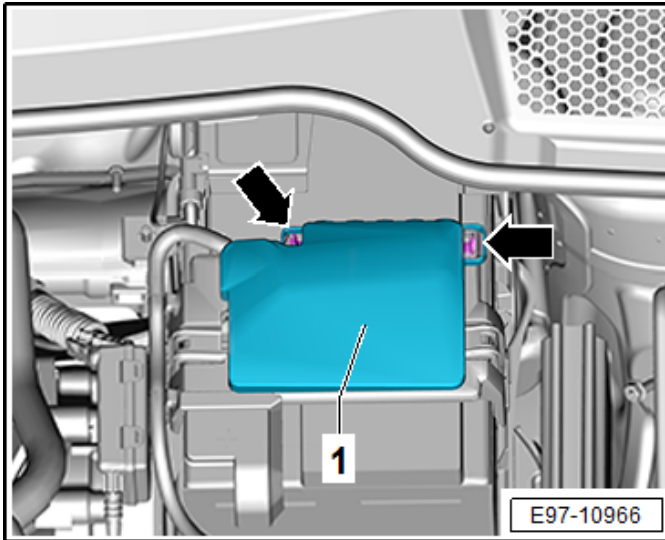

⚠ CAUTION

Risk of short circuit

The battery cable cover <1> must be installed before tightening the battery negative terminal clamp.

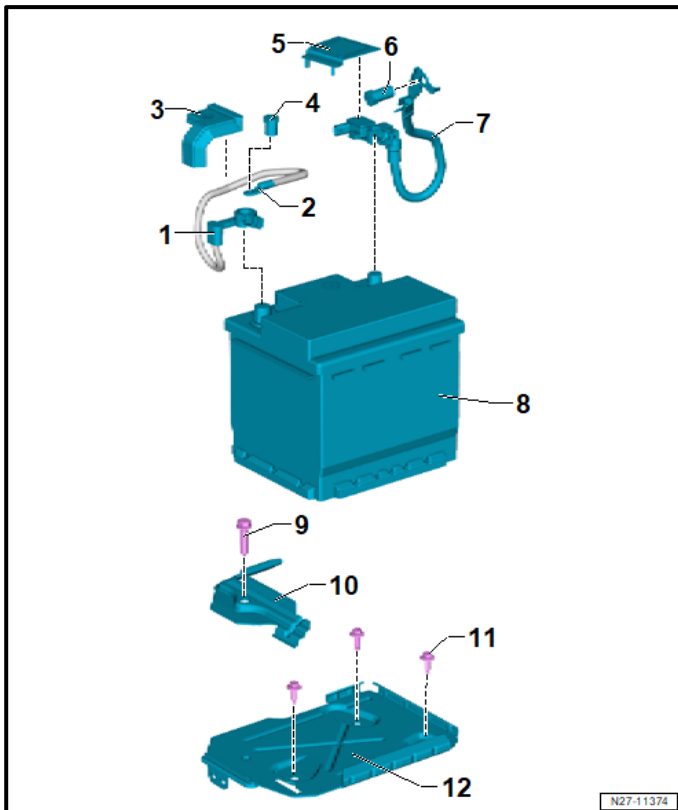

- Torque battery hold-down bolt <9> to 20 Nm.
- Torque battery terminals to 5 Nm.
- Torque power cables on top of battery to 6 Nm.
- Install covers.
- Install impact member and torque bolts to 20 Nm.

i TIP

The impact member and covers can also be installed at the very end of the repair. Doing so will make connecting and disconnecting the battery charger easier.

Proceed to Step 3 for performing vehicle software update via SVM.

Step 3 – Perform Software Update SVM

NOTE

Flashing times will vary. The time it takes to complete the software updates is dependent on several factors, including the workshop's internet download speed.

NOTE

Only one key can be in the vehicle when performing this software flash.

The vehicle key's battery must be ok.

Any additional keys must be a minimum of 20 meters away from the vehicle.

The car **MUST NOT** be hooked up to a high-voltage charger.

The seat belt must **NOT** be inserted into the buckle.

The driver door must be open.

NOTE

If a diagnostic session was started before the USB update in Step 1 was performed, address 005F and address 8125 must be re-identified before attempting SVM US30

Failure to do so can result in error code ERP0215E when the SVM is attempted.

- Address 005F and address 8125 software versions should = 0561



NOTE

The battery charger may shut off automatically after several hours due to a default setting. Each time the battery charger is reconnected, it must be turned OFF and then back ON to reset the charging start time.

- Turn battery charger OFF, then back ON.
- Connect battery charger.
- **Cycle the ignition OFF, then back ON.**
- Confirm that scan tool is communicating with the diagnostic head by USB <Green Arrow>.
 - If the Bluetooth symbol is shown <Red Arrow> then disconnect the diagnostic head from the vehicle and reconnect the USB cable to the diagnostic head and then reattach to the vehicle.
- Upon ODIS startup, verify the "Diagnosis" operating mode is selected <as shown>.
- Turn the hazards on.

⚠ CRITICAL REPAIR STEP

STOP STOP

- If any of the modules being updated are offline, the communication issue must be addressed prior to starting this procedure.
- Any module with a “Faulty Control Module” fault *that cannot be cleared*, must be addressed prior to starting the flash. The flash may fail for the affected control module.
- Diagnosis and repair of pre-existing conditions are not covered under this action.
- See Appendix A for the software change table.

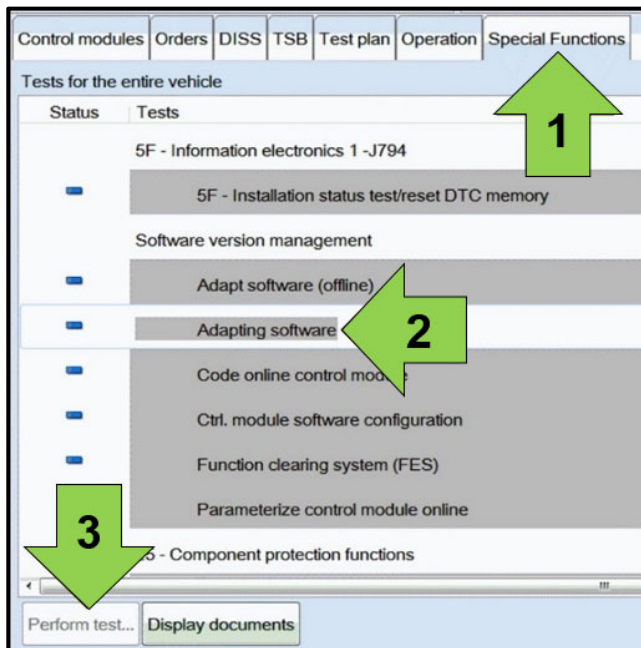

- Once the GFF scan is complete, select “Special functions” <arrow 1>, then “Adapting software” <arrow 2>, then select “Perform test” <arrow 3>.

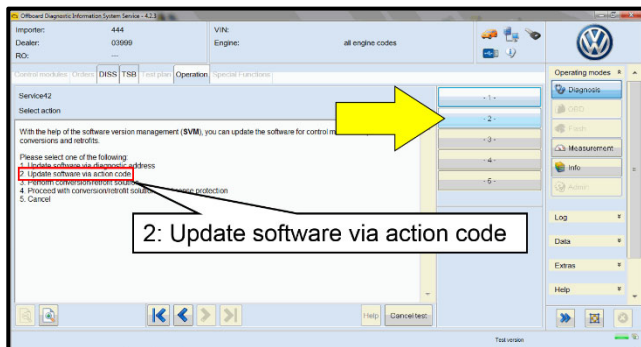

- Select the correct option to “Update software via action code”.

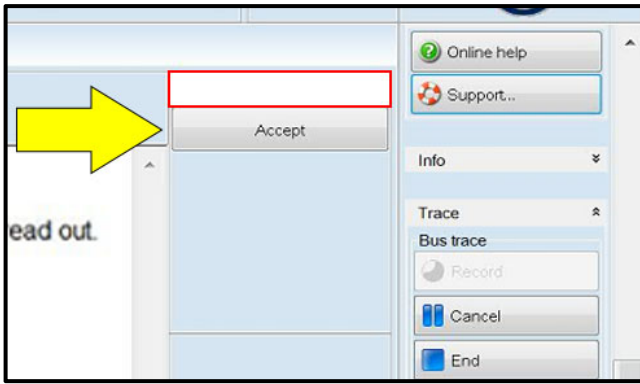

NOTE

Using Bluetooth or WiFi for this action is PROHIBITED!

Damage caused to electronic components during the SVM flash process is not covered.

- Enter the corrective action code (SVM code) as listed below.

SVM code
US30

- Select “Accept” <arrow> and follow the on screen prompts.

NOTE

Do not unplug the sound generator.

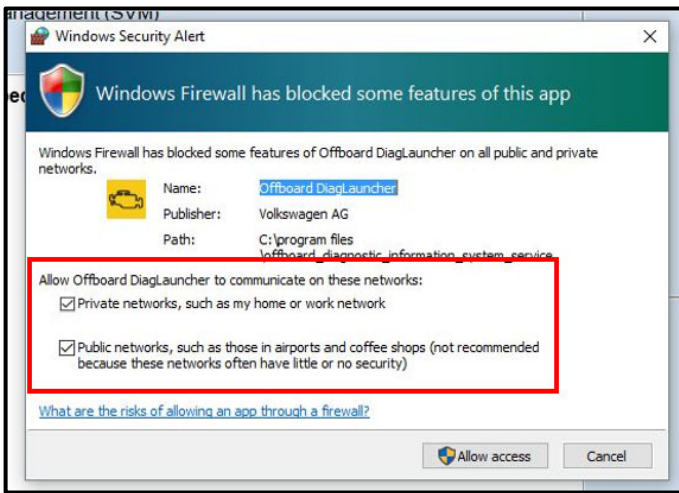

NOTE

When the Windows Firewall popup appears, ALL network options should be checked. Failure to do so could cause the update to fail when first attempting Software Cluster Embedded 1.

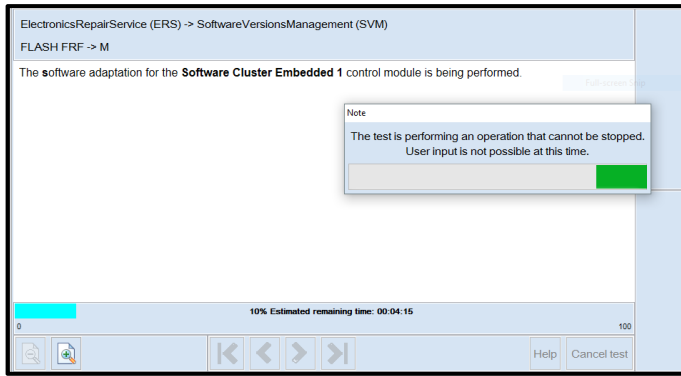

⚠ CRITICAL REPAIR STEP

STOP! STOP!

The initial update may take several minutes to start. Multiple control modules are updated during this procedure. Some modules will take a while to be updated. **DO NOT** cancel the update procedure, turn the ignition off, remove the battery charger, or interrupt the update procedure in any way. Doing so could cause irreparable damage to control units, which is **NOT** covered under this action.

NOTE

If the progress bar for the first update (Software Cluster Embedded 1) stops briefly at **6%** (it may also appear that the progress bar stops at 10% briefly, then quickly goes to the end), there may be a firewall issue.

NOTE

If error code ERP0215 occurs:

Cause:

On at least one control unit, the operating conditions for the measure are not fulfilled (for example, incorrect SW part number/HW part number/hardware/software):

Possible Corrections:

Manually identify the affected control module(s), or start a new GFF session and repeat SVM US30.
 Perform a bus sleep or reset the control module, then repeat SVM US30.

NOTE

If error code ERP0225E occurs:

Cause:

The measure cannot be carried out because of missing control unit data. Often not all necessary control units are “identified” or “reachable”.

Possible Corrections:

Make sure all necessary control units are identified according to the software table. If necessary, manually identify the module and repeat SVM US30.

If a module cannot be manually identified: switch off ignition > send diagnostic protocol online > disconnect diagnostic interface from vehicle > restart ODIS > remove the fuse for the module that had the failure for 10 seconds > reinstall the fuse > perform a bus sleep > start a NEW GFF session > identify the module > repeat SVM US30.

NOTE

If a message appears stating that the communication path cannot be changed to DoIP:

Send the diagnostic protocol online > cancel the test plan > turn the ignition OFF > disconnect the diagnostic head from the vehicle AND the diagnostic tester for a few minutes > restart ODIS > reconnect diagnostic head to vehicle and diagnostic tester > repeat SVM US30.

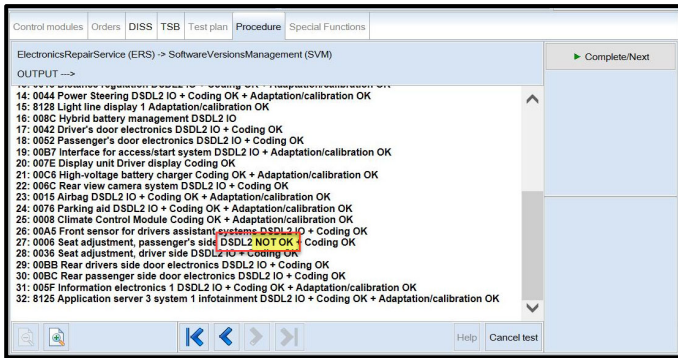

- Pay attention to the status report of the control module updates.
- Any module stating NOT OK will have to be updated again.
- Selecting “Complete/Next” will begin another attempt to update the control module.
- It may take more than one attempt to update every control module.

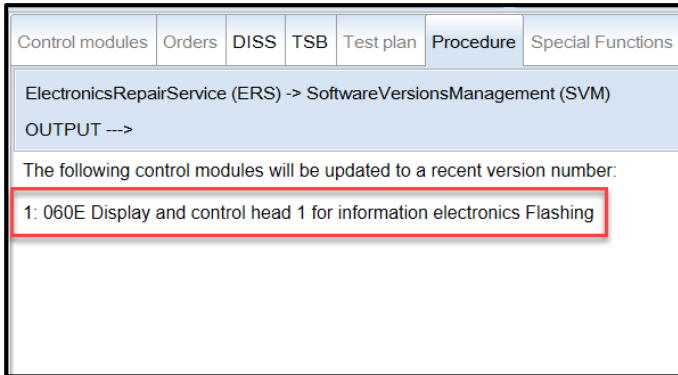

NOTE

If SVM US30 completed and the test plan states control module address 060E has to be updated again:

- Cancel the test plan
- Perform a bus sleep (see Step 4 for bus sleep instructions).
- **Restart the flash using SVM US30.**

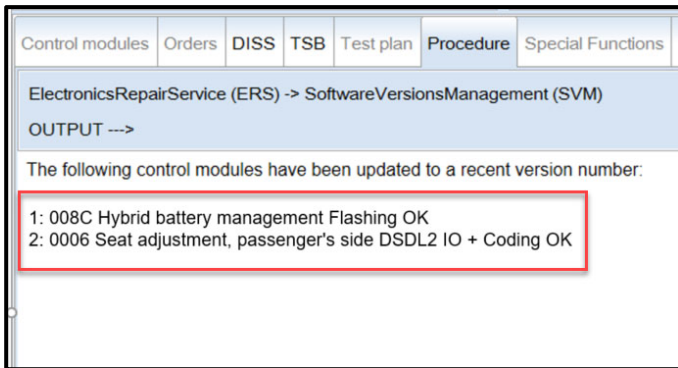

NOTE

If SVM US30 is repeated for any reason, address 008C and 0006 will be updated again.

This is normal.

- Do not end the diagnostic session
- **DO NOT proceed to the next SVM update until SVM US30 has 100% completed successfully.**

Proceed to Step 4 for performing vehicle bus sleep.

Step 4 – Perform Bus Sleep Procedure

- Carry out the following steps in the specified sequence to put the vehicle in a bus sleep.
- Switch off the ignition.
- Turn off the hazards.
- Remove diagnosis interface from the vehicle diagnosis connection.
- Remove battery charger from the 12V battery.
- Close front and rear lid as well as all doors.
- Lock vehicle.
- Move vehicle key (remote control) at least 20 meters away from the vehicle.
- Wait at least 15 minutes until the vehicle is in bus silence.
- Then unlock vehicle again.
- Connect and switch on battery charger.
- Insert diagnosis interface on vehicle diagnosis connection.
- Switch on the ignition.
- Place a vehicle key (remote control) in the center console on the reader coil.

Proceed to Step 5 for performing software configuration via SVM.

Step 5 – Perform Software Configuration via SVM



NOTE

The battery charger may shut off automatically after several hours due to a default setting. Each time the battery charger is reconnected, it must be turned OFF and then back ON to reset the charging start time.

- Turn battery charger OFF, then back ON.
- Connect battery charger.
- Turn the hazards on.
- Confirm that scan tool is communicating with the diagnostic head by USB <Green Arrow>.
 - If the Bluetooth symbol is shown <Red Arrow> then disconnect the diagnostic head from the vehicle and reconnect the USB cable to the diagnostic head and then reattach to the vehicle.
- Upon ODIS startup, verify the “Diagnosis” operating mode is selected <as shown>.
- Once the GFF scan is complete, select “Special functions” <arrow 1>, then “Adapting software” <arrow 2>, then select “Perform test” <arrow 3>.

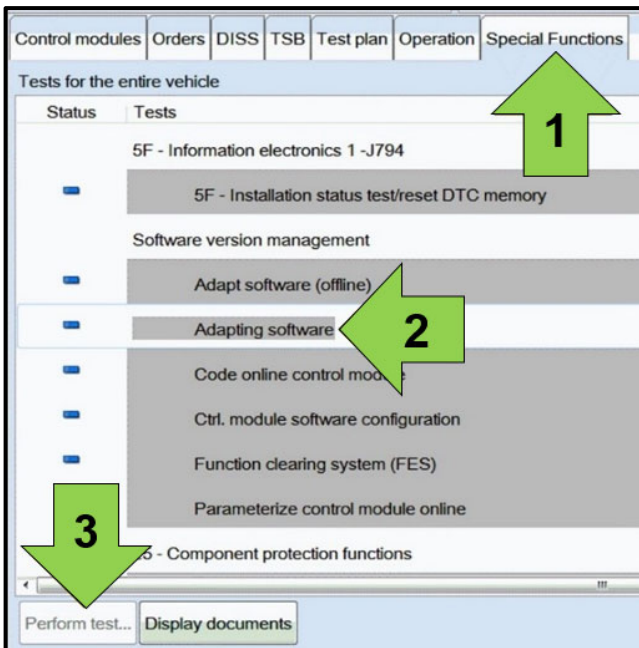
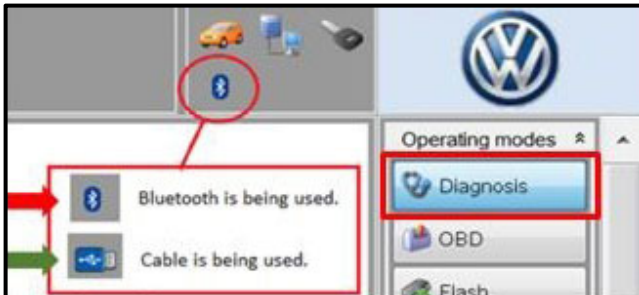

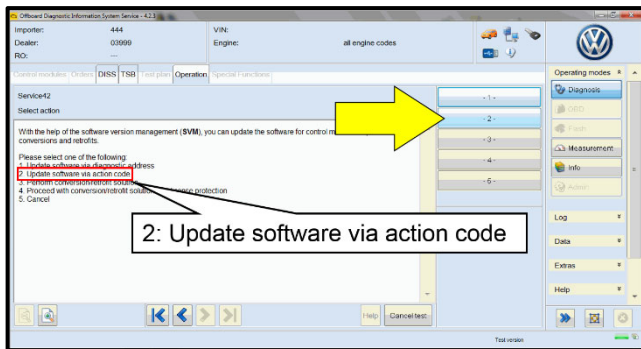

- Select the correct option to “Update software via action code”.

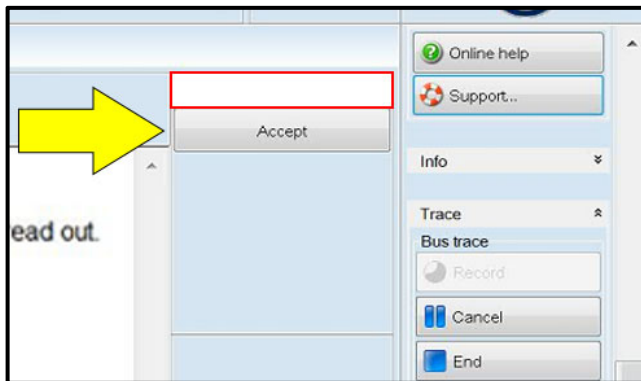

NOTE

Using Bluetooth or WiFi for this action is PROHIBITED!

Damage caused to electronic components (e.g. ECM, TCM, etc.) during the SVM flash process is not covered.

- Enter the corrective action code (SVM code) as listed below.

SVM code
US31

- Select “Accept” <arrow> and follow the on screen prompts.
- Pay attention to the status report of the control module updates.
- Any module stating NOT OK will have to be updated again.
- Selecting “Complete/Next” will begin another attempt to update the control module.
- Do not end the diagnostic session.

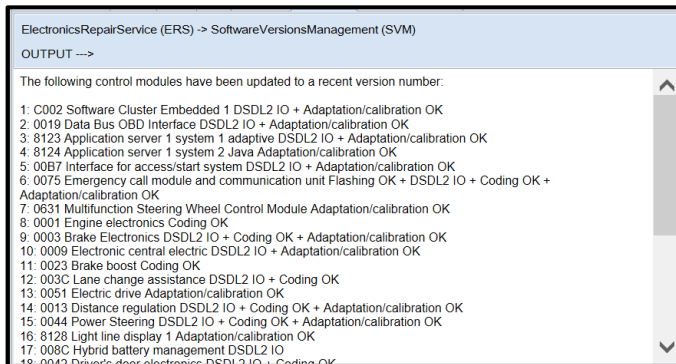

Proceed to Step 6 for performing Replace 12V Battery test plan via GFF

Step 6 – Perform Replace 12V Battery Test Plan

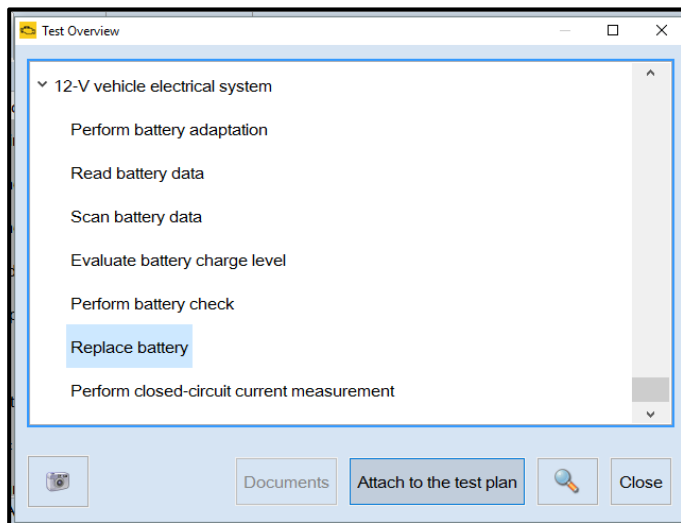

- Perform **“Replace battery”** test plan.
- Follow the on-screen prompts.
- Pay close attention to all steps outlined in the test plan and follow them exactly as described.
- Do not end the diagnostic session.

Proceed to Step 7 for performing Bus Sleep Procedure

Step 7 – Perform Bus Sleep Procedure

- Carry out the following steps in the specified sequence to put the vehicle in a bus sleep.
- Switch off the ignition.
- Turn off the hazards.
- Remove diagnosis interface from the vehicle diagnosis connection.
- Remove battery charger from the 12V battery.
- Close front and rear lid as well as all doors.
- Lock vehicle.
- Move vehicle key (remote control) at least 20 meters away from the vehicle.
- Wait at least 15 minutes until the vehicle is in bus silence.
- Then unlock vehicle again.
- Connect and switch on battery charger.
- Insert diagnosis interface on vehicle diagnosis connection.
- Switch on the ignition.
- Place a vehicle key (remote control) in the center console on the reader coil.

Proceed to Step 8 for performing Learn VKMS Test Plan via GFF

Step 8 – Perform VKMS Adaptation Test Plan

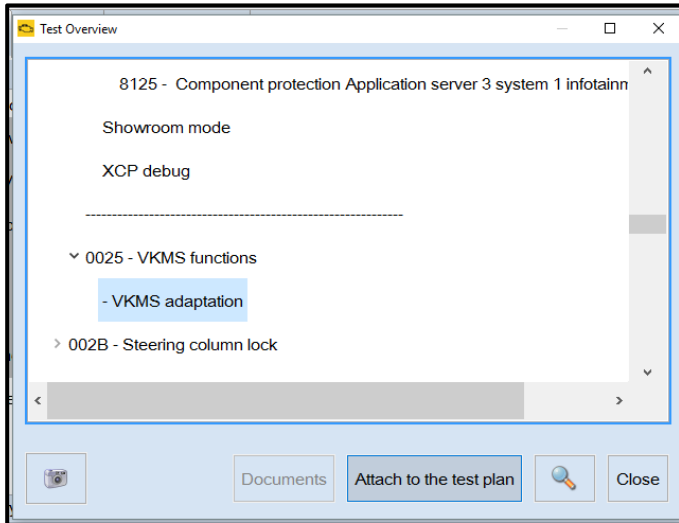

- Perform 0025 Immobilizer “VKMS Adaptation” test plan.

TIP

After selecting “Self Test,” use the search function and enter “VKMS” to aid in finding the test plan.

- Follow the on-screen prompts.
- Pay close attention to all steps outlined in the test plan and follow them exactly as described.
- Do not end the diagnostic session.

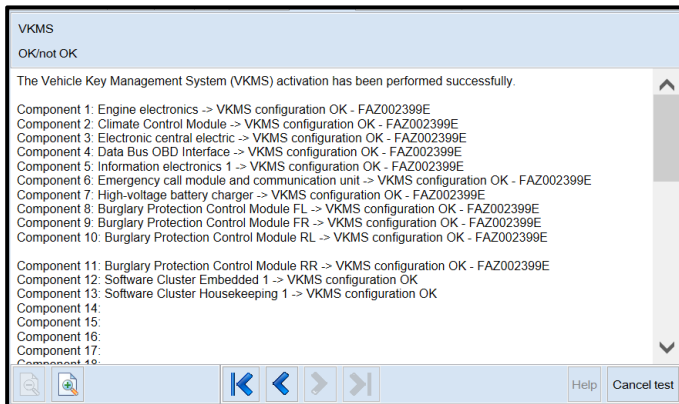

- Ensure each component shows the VKMS configuration is OK.
- If any component does not complete the VKMS adaptation, repeat the test plan.

Proceed to Step 9 for performing manual basic settings

Step 9 – Perform Manual Basic Settings

With the software update the basic settings of the steering angle sender -G85- and the end stops (soft stop) of the electric window lifter are lost.

- Perform manual basic settings of steering angle sender -G85-:
 - Create drive readiness.
 - Turn steering wheel completely to the left and hold in the end position for 3 seconds.
 - Turn steering wheel completely to the right and hold in the end position for 3 seconds.
 - Return steering wheel to straight-ahead position.
 - Yellow steering light in cluster should go out.
- Adapt end stops (soft stop) of the electric window lifter for all windows:
 - Lower window completely. Release the switch. Hold window switch in the down position, at the second detent for 3 seconds.
 - Raise window completely. Release the switch. Hold window switch in the up position, at the second detent for 3 seconds.

Proceed to Step 10 for Adjusting Service Interval

Step 10 – Adjusting Service Interval

NOTE

- The service interval display may be reset by the software configuration. The current service interval should have been read out at the beginning of this repair.
- It is also possible that the service interval could have been reset on a previous service visit if a software configuration was carried out on the vehicle. Therefore, the service interval should be compared to the vehicle's service records. If there is a discrepancy, the service interval values will have to be adjusted accordingly.
- After the software updates are complete, the adaptation channels will also change:
 - Pre-flash:
 - \$0541 (distance driven since the last inspection AND time since the last inspection)
 - Post-flash:
 - \$0548 (distance driven since the last inspection)
 - \$0549 (time since the last inspection)

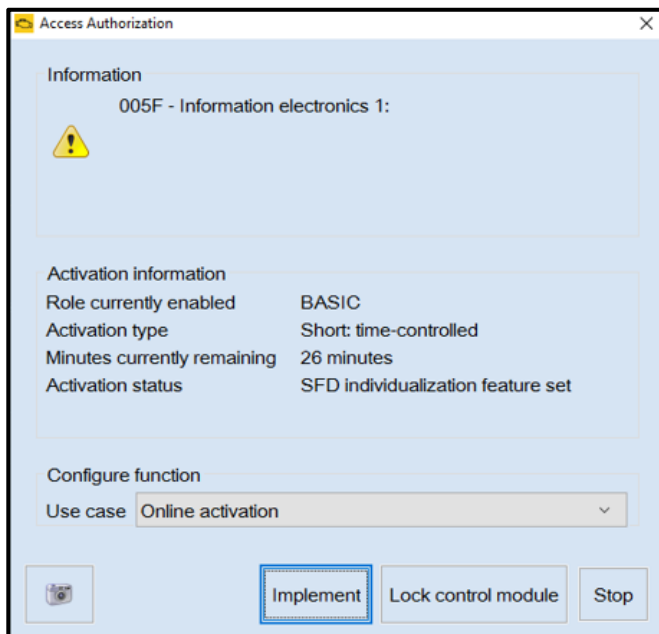

- From the OBD menu, go to: OBD > DA 005F > *Access authorization*.
- Select “Implement” and then enter ODIS login/password if prompted (to unlock SFD).
- Select “stop” to close the window.

- Using Operating mode “OBD”, check 005F adaptation channels \$0548 and \$0549 for the current service interval settings (OBD > DA 005F > Adaptations).
- If the values are the same as the previously recorded values, no change is necessary.
- If the values have changed, enter the correct values as needed.

Control modules Results

005F - Information electronics 1 (UDS / ISOTP / 10A035842J / 0561 / H20 / EV_MUICASSAFEPart / 00100 DTC Memory

Adaptation/parameter	RDID	Current value	Input	Unit
[LO]_FIX_Maximum_time_to_next_time_based_service_event		365		d
▼ Inspection, distance driven since the last inspection	\$0548			
[LO]_FIX_Set_mileage_since_last_mileage_based_service_event		12,500		km
▼ Inspection, time since the last inspection	\$0549			
[LO]_FIX_Set_time_since_last_time_based_service_event		325		d

Filter: inspect

Accept Restore Reset all

005F - ANP

TIP: Enter “inspect” in the Filter field <arrow> and both adaptation channels will be shown.

Proceed to Step 11 for performing GFF test plans for faults created by the flash process

Step 11 – Perform GFF Test Plans For All Faults Created by the Flash Process

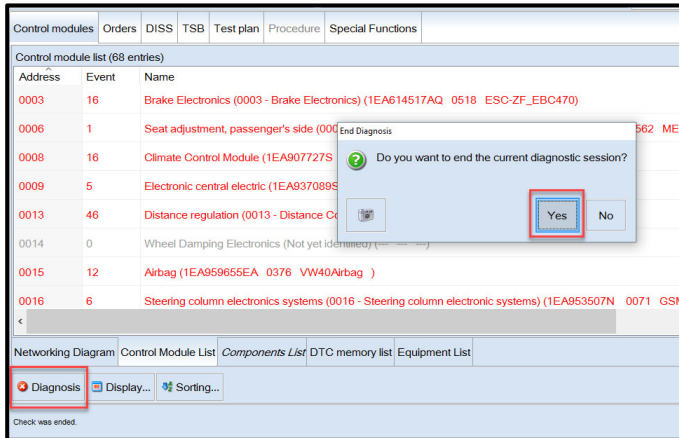

- Exit Diagnosis and select “Yes” to end the diagnostic session.

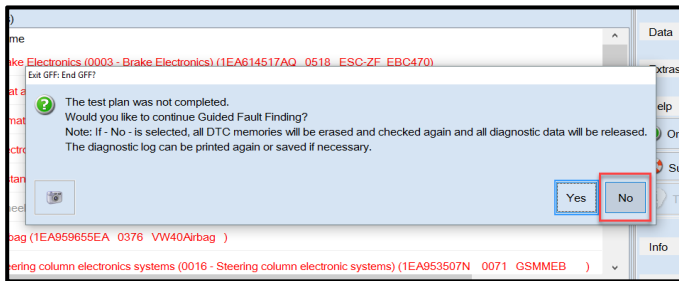

- When prompted to continue Guided Fault Finding, select “NO”.
- GFF will be exited and faults will be erased.

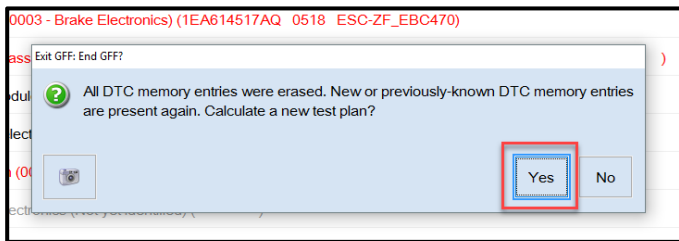

- Static faults created by the flash process will remain.
- When prompted, select “YES” to populate new test plans.

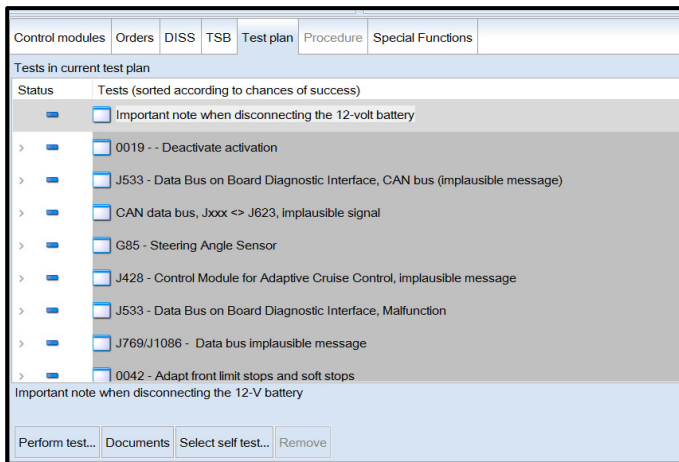

- Work through all test plans for faults created by the flash process.
- Reference any applicable TSBs that address “ghost” faults.
- Pay close attention to all steps outlined in the test plans and follow them exactly as described.
- Exit GFF and send diagnostic protocol online.

NOTE

Driver assist systems will not require re-calibration due to this software update.

NOTE

At the end of the diagnosis the diagnostic tester requires the calibration of the three-phase drive -VX54-.

The calibration does not have to be performed at the end of the diagnosis; it can be carried out without the diagnosis tester on a test drive above 20 mph (before returning the vehicle to the customer).

NOTE

Static faults may store in various control modules during the flash.

The ID Light may not operate as designed after the flash.

It may be necessary to perform the following in order to clear the faults and restore the ID Light operation:

- Drive the vehicle a short distance (around the parking lot, for example).
- Perform a bus sleep.

Proceed to Step 12 for providing the owner’s manual kit.

Step 12 – Provide the Owner’s Manual Kit

Note: this step can be performed while the software update is in progress

! NOTE

Dealers were sent an initial allocation prior to customer notification.

The allocation included a delivery of owner’s manuals and a separate delivery of tow hook supplements.

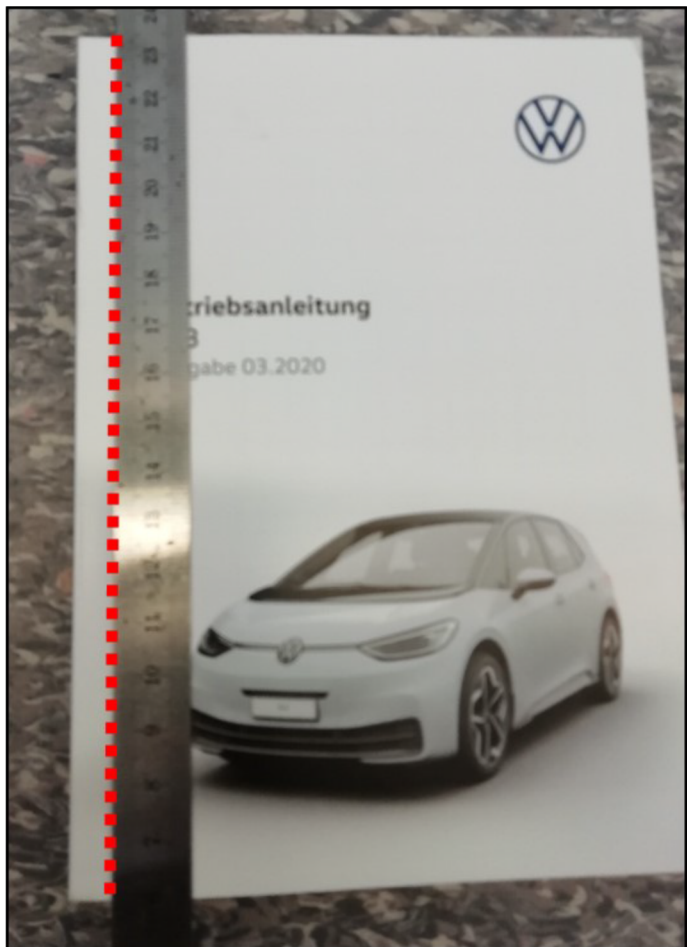

Replace the owner’s manual and provide a tow hook supplement.

- On the first page (inside) of the owner's manual enclosed in the vehicle there is the vehicle data sticker and information on PDI and date of delivery/registration.
- To ensure this information is not lost to the customer, cut out the first page of the owner's manual with a sharp knife, as shown in the illustration <red dotted line>.
- We recommend the use of a steel ruler or another suitable implement to guide the knife and ensure a straight cutting line.
- Include the cut-out page in the new owner's manual.

Criteria	Description
02 and 05	US English Kit (US English owner's manual + English tow hook supplement)
03 and 05	CAN English Kit (CAN English owner's manual + English tow hook supplement)
04 and 06	CAN French Kit (CAN French owner's manual + French tow hook supplement)

Proceed to Section C

Section C – Campaign Completion Label

Install Campaign Completion Label

- Fill out and affix Campaign Completion Label, part number CAMP 010 000, next to the vehicle emission control information label.

TIP

Ensure Campaign Completion Label does not cover any existing label(s).

Section D - Parts Return/Disposal

Properly store (retain), destroy or dispose of removed parts in accordance with all state/province and local requirements, unless otherwise indicated and/or requested through the Warranty Parts Portal (WPP) for U.S. and the Part Destruction and Core Disposition Report for Canada.

NOTE

Batteries have 15 month threshold to be used in vehicles. Please make sure you are using batteries in first in first out (FIFO) order, reducing the risk of obsolescence.

Interstate standard return process regarding expiration dates are to be used for this action.

Appendix A – Software Table

Diagnostic Address	New Part Number	New Software Version
C002	V04007003HM	0290
0019	1EA937012N	0292
0631	1EA959442H	0032
0637	1EA915181	1074
	1EA915181B	1074
00B7	5WA959436H	0725
	5WA959436J	0725
0075	11A035285C	0664
0001	0EA906012CP	2222
0003	1EA614517AQ	0518
0009	1EA937084B	0307
	1EA937086G	0307
	1EA937089S	0307
	1EA937089T	0307
	1EA937089Q	0307
0023	1EA909059AM	0625
003C	2Q0907686G	0287
0051	1EA907121AC	6044
0013	1EA907572H	0234
0044	1EA907144AQ	5033
060E	10A919606D	6085
	10A919606F	6085
	10A919606K	6085
	10A919606L	6085
	10A919606M	6085
	10A919606P	6085
	10A919606R	6085
	10A919606S	6085
	10A919605K	3080
	10A919605H	3080
	10A919605H	2103
	10A919605K	2103
	10A919605L	2103
	10A919605M	2103
10A919605P	2103	
8128	11B919451C	0107
06D1	OZ1915140F	1000
06D5	OZ1915140F	1000
06D9	OZ1915140F	1000
06F1	OZ1915140F	1000
008C	OZ1915184G	1030
0042	1EA959593B	0550

The repair information in this document is intended for use only by skilled technicians who have the proper tools, equipment and training to correctly and safely maintain your vehicle. These procedures are not intended to be attempted by "do-it-yourselfers," and you should not assume this document applies to your vehicle, or that your vehicle has the condition described. To determine whether this information applies, contact an authorized Volkswagen dealer. ©2022 Volkswagen Group of America, Inc. and Volkswagen Canada. All Rights Reserved.

0052	1EA959592B	0550
007E	10A920320C	0531
00C6	1EA915684DB	1019
	1EA915684DJ	1019
	1EA915684EK	1019
	1EA915684DQ	1019
006C	1EA980556F	0394
0015	1EA959655EA	0376
8105	1EA907190G	1142
0076	1EA919294D	0421
0008	1EA907727S	0425
	1EA907727T	0425
00A5	1EA980654K	5321
	1EA980653C	5321
0006	1EB959760H	0562
00BB	1EA959597B	0550
00BC	1EA959596B	0550
00CE	1ED907121AB	8351
005F	10A035842J	0561
0036	1EB959760H	0562