

TO: Mercedes-Benz Principals, General Managers, Sales Managers, Service Managers, Parts Managers	FROM: Anthony Washington, Department Manager, Regulations and Certifications
<b>Re: Recall Campaign Launch Notification Models 907 (Sprinter) Model Years 2019-2020 Remove Power Sliding Door Function</b>	DATE: December, 2022

## IMPORTANT RECALL CAMPAIGN INFORMATION

Please see the attached documents related to the campaign listed above

Please note that electric sliding door function will be removed with this campaign.

Please refer to following pages (CLICK) for specific work instructions for applicable options.

### [Page 4](#)

with code EL9 (Two-way loudspeaker system in front and rear)  
with code ZU8 (National version for USA)  
with T55 (electric actuation of right sliding door)

### [Page 40](#)

with code ZU8 (National version for USA)  
**WITHOUT** code EL9 (Two-way loudspeaker system in front and rear)  
with T55 (electric actuation of right sliding door)

### [Page 78](#)

with code EL9 (Two-way loudspeaker system in front and rear)  
with code ZU8 (National version for USA)  
with T50 (electric closing assist of right sliding door)

### [Page 108](#)

with code ZU8 (National version for USA)  
**WITHOUT** code EL9 (Two-way loudspeaker system in front and rear)  
with T50 (electric closing assist of right sliding door)



<b>Campaign No. :</b>	<b>Campaign Desc. :</b>	<b>Remove Power Sliding Door Function</b>
<b>2022120001</b>	<b>VS3SCHIEBT</b>	
<p>This is to notify you of a <b>Recall Campaign Launch</b> to remove power sliding door function on approximately <b>56</b> MY19-20 Mercedes-Benz Sprinter vans. The recall campaign will be visible on the <a href="http://www.safercar.gov">www.safercar.gov</a> website and may generate questions from customers. All affected VINs will be flagged "<b>OPEN</b>" in VMI and <b>cannot be sold</b> until remedied.</p>		
<b>Background</b>		
<b>Issue</b>	<p>Mercedes-Benz AG ("MBAG"), the manufacturer of Mercedes-Benz vans, has determined that certain Sprinter vehicles from platform 907 (VS30) that are equipped with an optional electric sliding door may have been manufactured with an auxiliary lock on the sliding door that was not specified for use in connection with an electric sliding door. Affected vehicles that have this auxiliary lock may show an increased outward displacement of the sliding door in the event of a crash, which could increase the risk of injuries for vehicle occupants in a crash. As a result, the auxiliary locks do not comply with FMVSS 226 (<i>Ejection Mitigation</i>).</p>	
<b>What We're Doing</b>	<p>MBUSA will conduct a voluntary recall campaign. An authorized Mercedes-Benz Sprinter dealer will convert the electric sliding function of the sliding door into a manual function for which the installed auxiliary lock is specified.</p>	
<b>Parts</b>	<p><b>Part numbers are verified.</b>  <b>Place order based on the code rule (4 different variations available)</b></p>	
<b>Vehicles Affected</b>		
<b>Vehicle Model Year(s)</b>	2019-2020	
<b>Vehicle Model (s)</b>	Sprinter(907)	
<b>Vehicle Populations</b>		
<b>Total Recall</b>	<b>56</b>	
<b>Dealer Inventory</b>	<b>0</b>	
<p><b>Given this notice, it is a <u>violation of Federal Law</u> for a dealer to sell or lease any <u>new</u> vehicles in dealer inventory covered by this notification until the vehicle has been repaired.</b></p> <p><b>Loaner and demonstrator vehicles may continue to be driven, but must not be retailed until repaired.</b></p> <p><b>Additionally, given this notice, it is a <u>violation of Federal Law</u> for rental companies to rent new vehicles covered by this notification until the vehicle has been repaired.</b></p>		
<b>Next Steps/Notes</b>		
<b>Customer Notification Timeline</b>	An owner notification letter will be mailed in January 2023.	
<b>AOMS/SOMS</b>	AOMS – This recall may generate questions from your dealers. Please forward this notice to your dealers ASAP.	
<b>Rental Fleet Partners</b>	This recall may affect vehicles in your fleet. Please contact your respective MBUSA fleet representative for further information and next steps. For repairs, please contact your preferred MBUSA dealer.	
<p>While we regret any inconvenience this may cause, we are determined to maintain a high level of vehicle quality and customer satisfaction.</p>		





Campaign No. 2022120001, December, 2022

TO: ALL MERCEDES-BENZ CENTERS

SUBJECT: **Model 907 Sprinter, Model Year 2019-2020**  
**Remove Power Sliding Door Function**

Mercedes-Benz AG (“MBAG”), the manufacturer of Mercedes-Benz vans, has determined that certain Sprinter vehicles from platform 907 (VS30) that are equipped with an optional electric sliding door may have been manufactured with an auxiliary lock on the sliding door that was not specified for use in connection with an electric sliding door. Affected vehicles that have this auxiliary lock may show an increased outward displacement of the sliding door in the event of a crash, which could increase the risk of injuries for vehicle occupants in a crash. As a result, the auxiliary locks do not comply with FMVSS 226 (Ejection Mitigation).

MBUSA will conduct a voluntary recall campaign. An authorized Mercedes-Benz Sprinter dealer will convert the electric sliding function of the sliding door into a manual function for which the installed auxiliary lock is specified.

Prior to performing this Recall Campaign:

- Please check VMI to determine if the vehicle is involved in the Campaign and if it has been previously repaired.
- Please review the entire Recall Campaign bulletin and follow the repair procedure exactly as described.

Please note that Recall Campaigns **do not expire** and may also be performed on a vehicle with a vehicle status indicator.

Approximately **56** vehicles are involved.

Order No. V-RC-2022120001 This bulletin has been created and maintained in accordance with MBUSA-SLP S423QH001, Document and Data Control, and MBUSA-SLP S424HH001, Control of Quality Records.



Mercedes-Benz

Work instructions

---

**Van**

**Group 72**  
**CODE: VS3SCHIEBT**

**SM72.16-D-0008A**  
**17.11.2022**

**Sliding door conversion (code: VS3SCHIEBT, acc. no.: 72 951 62)**

**Model**      **907.6/7**

**with code EL9 (Two-way loudspeaker system in front and rear)**

**with code ZU8 (National version for USA)**

**with electric actuation of right sliding door**



<b>SM72.16-D-0008A</b>	<b>Sliding door conversion (code: VS3SCHIEBT, acc. no.: 72 951 62)</b>	<b>09.11.2022</b>
------------------------	--	-------------------

**Model**      **907.6/7**  
**with code EL9 (Two-way loudspeaker system in front and rear)**  
**with code ZU8 (National version for USA)**  
**with electric actuation of right sliding door**

**Operation no. of the operation texts or standard texts and flat rates**

Category	Op. no.	Operation text	Time	Damage Code	Code
L	02 0980	Operations: Modify sliding door on vehicle with code T55/EL9/V40	6.5 hrs	72 951 62	VS3SCHIEBT

**Important!**

On the affected vehicles, the sliding door is converted from electrical to mechanical actuation.

**Replacement parts ordering:**

Before ordering the required replacement parts, the special equipment code T55 (Electrical actuation for right sliding door) must be removed from the Vehicle Documentation (VeDoc). Only then can the correct replacement parts can be determined using XENTRY Parts Information.

**Vehicle documentation (VeDoc):**

Changes in VeDoc can only be made by users with write permission.

If no-one with change authorization is available, a ticket must be created in the "XENTRY Support and Feedback (XSF)" system for "Vehicle data/VeDoc".

Please note that the XSF ticket has to be approved by the national organization, something which involves additional processing time.

It may take a few days for the entry to be visible in VeDoc.

**In the event of problems:**

If problems arise while carrying out the service measure, please create a PTSS case.

To do this, use the "DTS pre-case checklist".

The most recent version is always available via the XENTRY Portal.

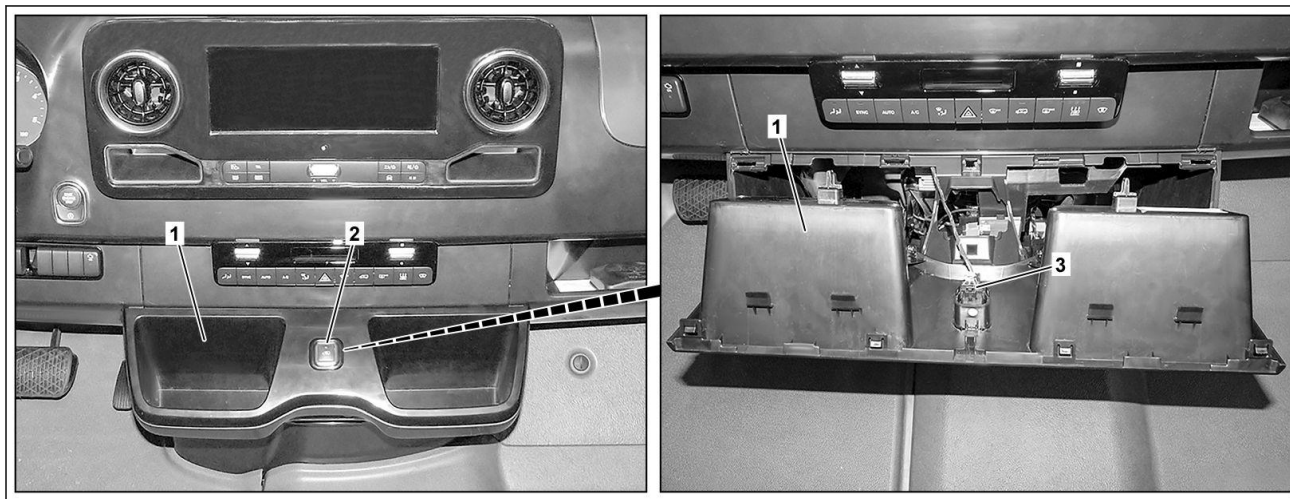

D72.16-A045-08

**Shown on vehicle with automatic transmission**

- 1 Stowage compartment
- 2 Switches
- 3 Connector

**Shown on vehicle with code T74  
(Grab handle for entrance)**

- 5 B-pillar paneling
- 6 Switches
- 7 Connector



D72.16-A043-76

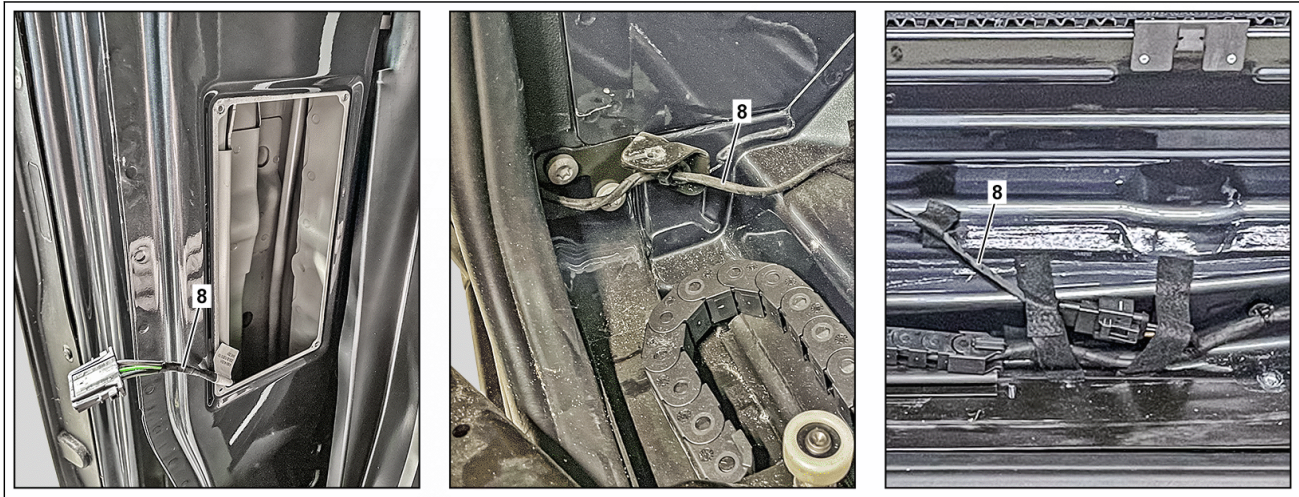

D72.16-A051-78

8 Closing assist motor electrical wiring harness

36 Retaining bolt



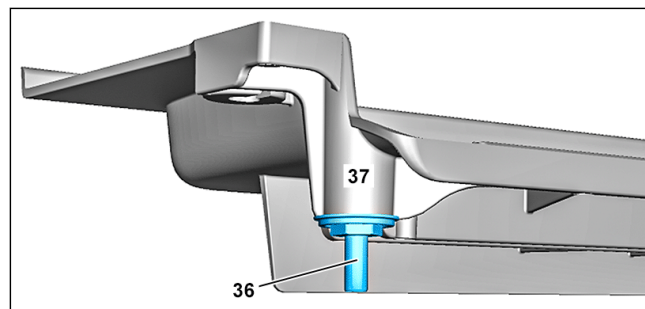





37 Guide rail





































D72.16-A058-80











<p><b>Warning</b></p>	<p><b>Risk of injury</b> caused by fingers being jammed or pinched when removing, installing or aligning hoods, doors, trunk lid/rear-end door or sliding roof.</p>	<p>No parts of the body or limbs should be within the operating area when the components are moving.</p>	<p>AS00.00-Z-0011-01A</p>
<p><b>Caution</b></p>	<p><b>Risk of injury</b> caused by scraping or cutting body parts on sharp vehicle parts</p>	<p>Always wear protective gloves when working on or near sharp and non-deburred vehicle parts. Deburr repair panels.</p>	<p>AS00.00-Z-0017-01A</p>
<p><b>Notice</b></p>	<p>Information on preventing damage to electronic components due to electrostatic discharge</p>		<p>AH54.00-P-0001-01A</p>
<p><b>Notice</b></p>	<p>Notes on carrying out repair work in the vehicle interior</p>		<p>AH68.00-D-0001-01KOS</p>
<p><b>Notice</b></p>	<p>Notes on retrofitting electrical/optical lines</p>		<p>AH82.00-P-0000-01A</p>



	<b>Check</b>		
1	Check if vehicle is affected by measure.		
	<b>Update Vehicle Documentation (VeDoc)</b>		
2	Remove special equipment from online vehicle data card.	 Remove existing code T55 (Electrical actuation for right sliding door).	
3	Attach "Sliding door converted as per SM72.16-D-0008A note" under field organization texts to KG72.		
	<b>Remove</b>		
4 	Detach ground line of on-board electrical system battery.		AR54.10-D-0029TS
5	Remove component parts in vehicle interior for sliding door conversion.		<a href="#">Page 29</a>
6 	Remove stowage compartment (1) with switch (2) for electric sliding door.	 The stowage compartment (1) and switch (2) are no longer required. <b>Information on wiring diagram:</b> Right stowage compartment sliding door pushbutton switch (S169/2)	AR68.10-D-1513TS
7	Strap down plug (3) of switch (2) using cable ties on factory-installed electrical wiring harness or at a suitable point.	 The plug (3) is no longer required.	
8 	Remove B-pillar trim (5) on front passenger side with switch (6) for electric sliding door.	Model 907.6/7  The B-pillar trim (5) and switch (6) are no longer required. <b>Information on wiring diagram:</b> Right sliding door button (S159/8)	AR68.30-D-4706TS

9	Strap down plug (7) for switch (6) using cable ties on factory-installed electrical wiring harness or at a suitable point.	 The plug (7) is no longer required.	
10 	Remove closing assist motor with lock striker in C-pillar.	 The closing assist motor is no longer required.	AR72.16-D-0002TSR
11 	Remove lower guide rail for sliding door.	Model 907.6/7  The lower carriage is no longer required.	AR72.16-D-7816TS
12	Remove closing assist motor electrical subharness (8).	 To do so, unclip electrical subharness (8), guide it out of C-pillar then disconnect electrical connector.  The electrical subharness (8) is no longer required.  Clip remover	<a href="#">452 589 01 63 00</a>
13 	Remove sliding door.	Model 907.6/7	AR72.16-D-1260TSB
	<b>Modify sliding door</b>		
14 	Remove switch for deactivation of electric sliding door.	 The switch is no longer required.	AR72.16-D-0003TSR
15 	Remove motor for electric sliding door with cable.	 The engine and cable are no longer required.	AR72.29-D-5901TS
16 	Remove electric sliding door control unit.	 The control unit is no longer required.	AR72.29-D-5898TS
17 	Remove anti-entrapment strip for electric sliding door.		AR72.29-D-5890TS

18	Remove center carriage for sliding door.		
 AR		Model 907.6/7	AR72.16-D-2230TSB
19	Remove the lock for the sliding door.		
 AR		Model 907.6/7	AR72.16-D-4035TSB
20	Install new sliding door lock.		
 AR		Model 907.6/7  Install outside door handle cable only. Do not attach remaining cables.	AR72.16-D-4035TS
21	Modify electrical wiring harness in sliding door.		<a href="#">Page 10</a>
22	Remove door handle.		
 AR		 Only remove door handle far enough to gain access to cables.	AR72.16-D-6601TS
23	Modify cables in sliding door.		<a href="#">Page 10</a>
		 Operation steps 3 to 9 of document reference.	
24	Modify detachable parts on sliding door.		<a href="#">Page 10</a>
		 Operation steps 10 to 17 of document reference.	
25	Install new center sliding carriage of sliding door.		
 AR		Model 907.6/7	AR72.16-D-2230TS
	<b>Retrofit wiring harness in vehicle interior</b>		
26	Fabricate wiring harness for sliding door. Wiring diagram for sliding door		
 PE		 Wiring harness repair kit, basic	PE72.16-D-2001LAA <a href="#">Page 24</a> <a href="#">000 589 13 99 00</a>
27	Retrofit wiring harness for sliding door. 000 588 00 84 00 Heat gun Repairing wiring harness using solder connectors Wiring diagram for sliding door Wiring diagram for loudspeakers		
 WS  AR  PE  PE		 Reflector  Adapter  Wiring harness repair kit, basic	WS54.00-P-0049B AR00.19-P-0100-09A PE72.16-D-2001LAA PE82.62-D-2102LAA <a href="#">Page 16</a> <a href="#">220 589 01 99 41</a> <a href="#">220 589 01 99 42</a> <a href="#">000 589 13 99 00</a>

	<b>Install</b>		
28	Attach new retaining bolt (36) to new lower guide rail (37).	 20 Nm	
 AR	Install new lower sliding door carriage.	 New lower carriage is supplied with flexible power duct and cable.	AR72.16-D-7844TSA
30	Install new lower guide rail (37).		AR72.16-D-7816TS
 AR	Retrofit reinforcement for lock striker in C-pillar.		<a href="#">Page 27</a>
32	Install sliding door.	Model 907.6/7	AR72.16-D-1260TS
 AR	Adjust sliding door.		AR72.16-D-1023TS
 AR	Install new B-pillar trim on front passenger side.	Model 907.6/7	AR68.30-D-4706TS
 AR	Install new lower center stowage compartment on instrument panel.		AR68.10-D-1513TS
36	Install removed component parts in vehicle interior for sliding door conversion.		<a href="#">Page 29</a>
 AR	Connect ground line of on-board electrical system battery.		AR54.10-D-0029TS
	<b>SCN coding</b>		
 AD	Connect diagnostic system.	 It is absolutely essential to precisely follow the operation steps as described in the vehicle diagnosis system.	AD00.00-D-2000-06TS

39 AR	Connect charging equipment.	<p>⚠</p> <p>During the entire work procedure a sufficiently large voltage supply must be provided for the vehicle's on-board electrical system. Otherwise any undervoltage that occurs may damage the control units.</p> <p><b>i</b></p> <p>Follow the operating instructions for the charger.</p> <p><b>i</b></p> <p>Use the charger to ensure that an adequate power supply (min. 12.5 V) is provided for the on-board electrical system battery.</p>	AR54.10-D-1127TS
40 AR	Perform SCN coding on signal acquisition and actuation module (SAM) control unit.	<p><b>i</b></p> <p>Under the "Control unit adaptations" menu item, follow the instructions for "SCN coding".</p>	AR54.21-D-0015TS
41 AR	Remove charger from vehicle.		AR54.10-D-1127TS
	<b>Check</b>		
42	Check sliding door for correct opening and closing.	<p><b>i</b></p> <p>See Operator's Manual.</p>	
43	Perform key function test.	<p><b>i</b></p> <p>See Operator's Manual.</p>	

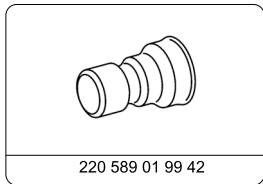

Adapter

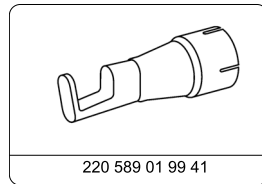

Reflector

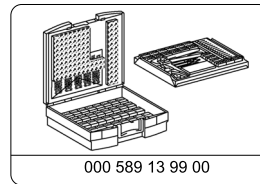

Wiring harness repair kit, basic

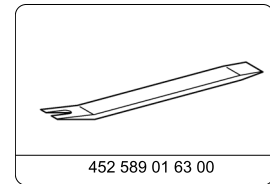

Clip remover

**Parts ordering note**

<b>Part no.</b>	<b>Designation</b>	<b>Quantity</b>
A 906 630 33 00	C-pillar	1
A 910 763 01 00	Sliding base in center	1
N 000000 001152	Screw	2
A 906 720 02 04	Lock striker	1
A 000 984 31 29	Screw	2
A 910 730 39 00	Door lock (bottom)	1
A 907 730 41 00	Door lock (top)	1
N 000000 001145	Screw	2
A 906 733 00 14	Bracket	1
A 907 730 42 00	Cable	1
A 910 760 15 00	Cable	1
A 910 760 16 00	Cable	1
A 000 995 51 14	Line fastener	5
A 907 820 38 00	Sliding base bottom	1
N 000000 000455	Screw	2
A 910 683 18 00	Stowage tray	1
A 906 691 01 33 9051	Cap	1
A 907 631 02 00	Bracket	1
A 907 690 38 00 9051	Right sliding door B-pillar trim, grab handle	1
A 906 692 12 22	Cover (on vehicle with code V36 Roof lining)	2
A 906 692 07 22 9051	Cover	1
A 910 998 02 50 9051	Cover plug	n. B.
A 910 998 00 50 9051	Cover plug	n. B.
A 100 987 05 44	Plug	1
A 906 766 00 97	Cover	1
	Parts for electrical wiring harness:	
	Electric lines (available on free market, observe specifications)	4
A 013 545 76 26	Female contact	1
A 001 982 57 02	Cable lug (ground connection)	1
A 001 545 59 80	Seal	4
A 009 545 81 26	Female contact	4
A 000 545 78 80	Plug	4
A 000 995 25 94	Cable tie	n. B.
A 000 989 84 85 10	Fabric tape	n. B.

SM72.16-D-0008-01SG	Convert sliding door (code: VS3SCHIEBT, acc. no.: 72 951 62)		
---------------------	--	--	--

**Model 907.6/7**  
**with code EL9 (Two-way loudspeaker system in front and rear)**  
**with code ZU8 (National version for USA)**  
**with electric actuation of right sliding door**

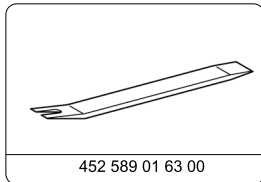

452 589 01 63 00

Clip remover

**Repair materials**

Number	Designation	Order number
BR00.45-Z-1025-04A	Cleaner	A 005 989 19 71

**Refit electrical wiring harness**

Shown on model 907.7 with code EL9 (2-way speaker system, front and rear)

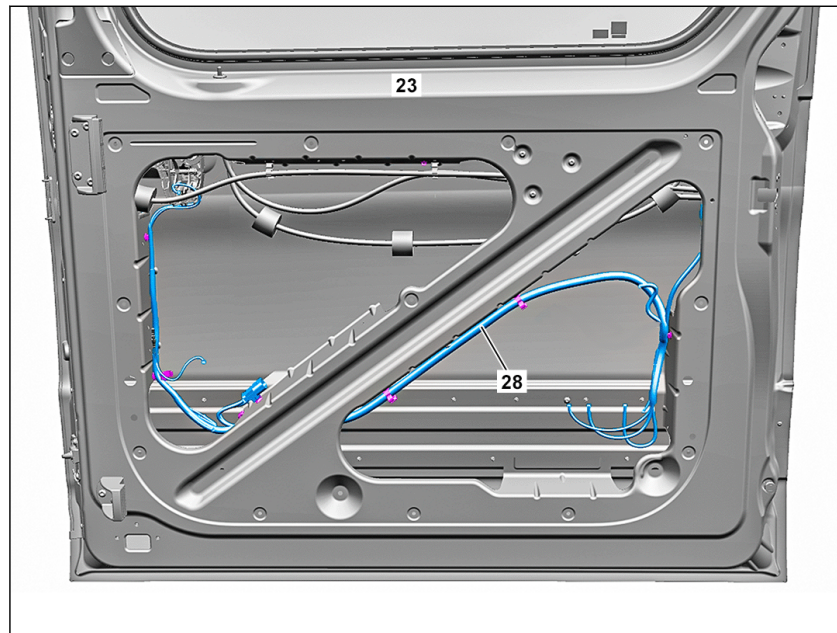

D72.16-A049-76

- 1 Remove electrical wiring harness (28).



To do so, unclip electrical wiring harness (28) from sliding door (23).

The number of fastenings can vary here, depending on the equipment installed.



The electrical wiring harness (28) is no longer required.

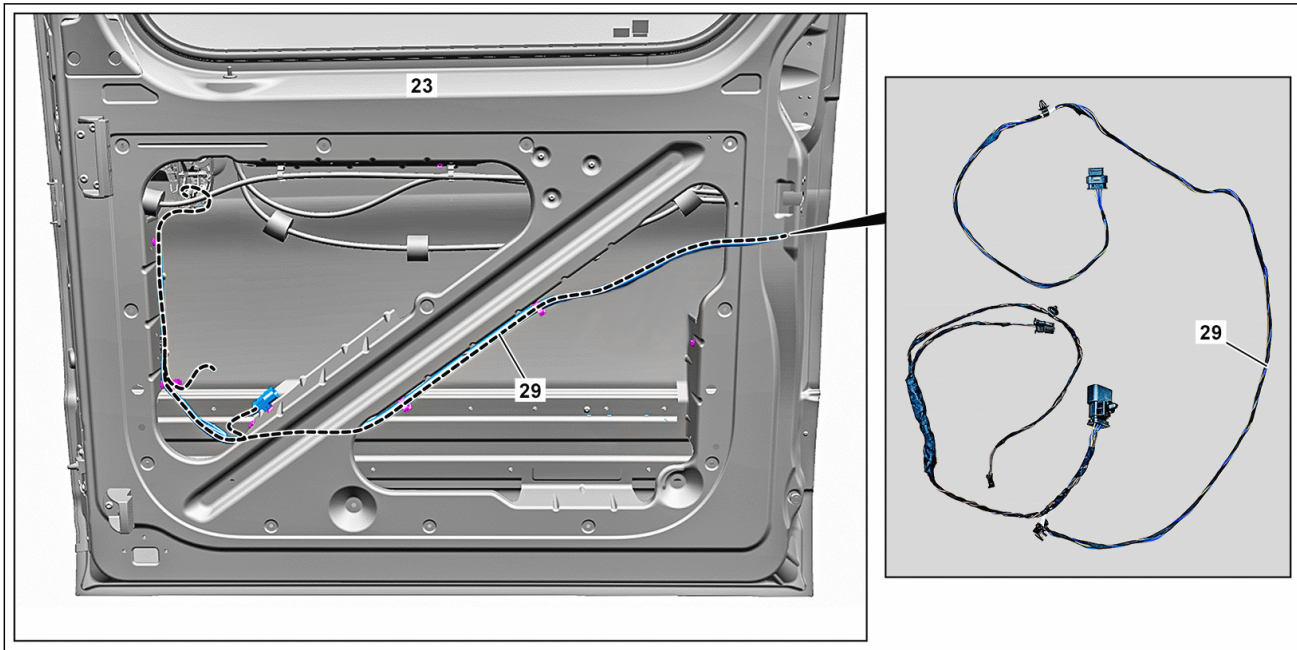

D72.16-A050-79

**Shown on model 907.7 with code EL9 (2-way speaker system, front and rear)**

- 2 Install new electrical wiring harness (29) as shown.



Order part number for electrical wiring harness (29) according to list below.



Continue in the higher-level service document.

-----

**Refit cables**



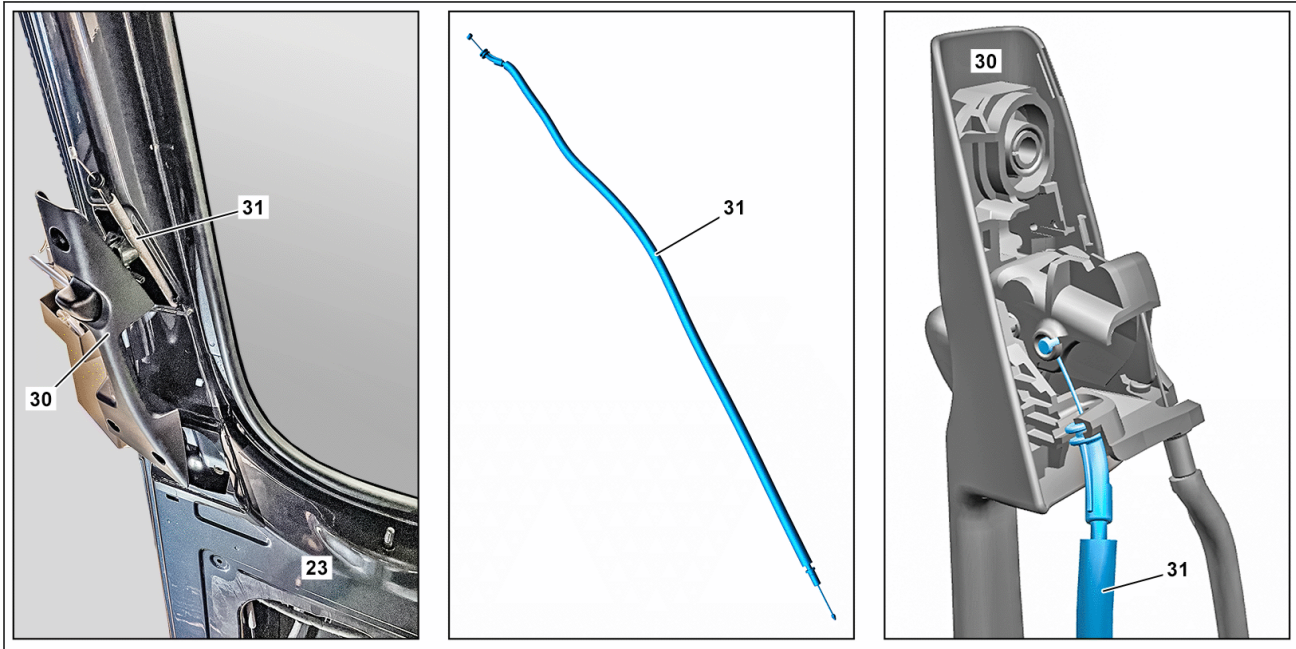

D72.16-A054-79



- 3 Route cable (31) through sliding door (23) to door handle (30).  
 ⚠ Handle cables carefully and do not kink them.  
 Damage may occur otherwise.

**i**  
 A 910 760 16 00

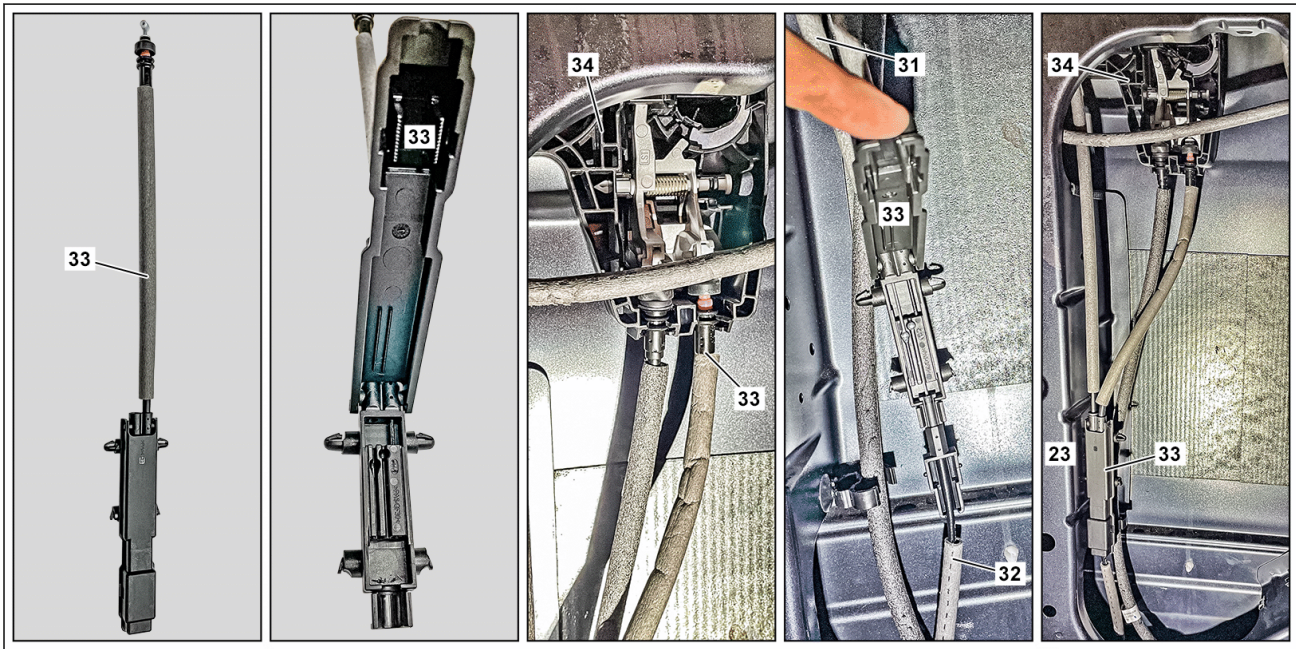
- 4 Install cable (31) in door handle (30).



D72.16-A056-79

- 5 Open cable (33).  
  
A 910 760 15 00
- 6 Install cable (33) in bearing bracket (34).
- 7 Install cable (31) and cable (32) in cable (33).
- 8 Close cable (33) and clip into sliding door (23).  
  
Continue in the higher-level service document.
- 

### Modify sliding door detachable parts

- 9 Remove anti-entrapment strip (21) from trim (22).



To do so, remove anti-entrapment strip (21) using  clip remover then remove adhesive tape.



The anti-entrapment strip (21) is no longer required.

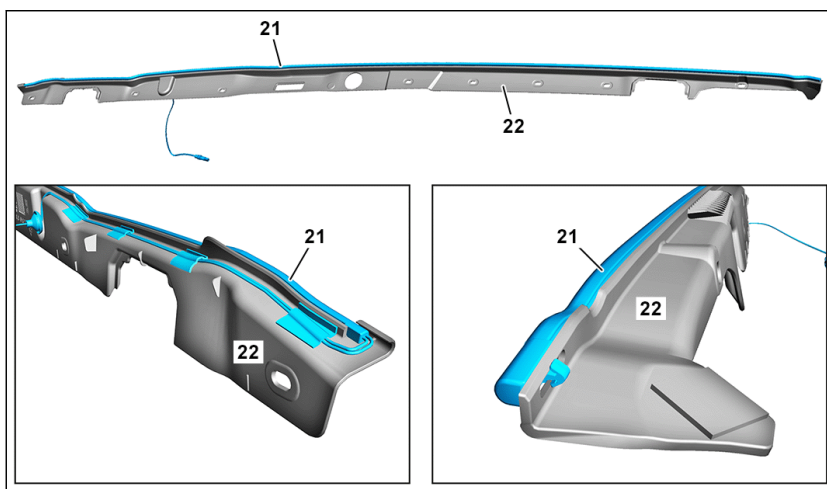

D72.16-A052-75

- 10 Install trim (22) on sliding door (23).



To do so, install expansion rivet (24).

- 11 Install trim (25) on sliding door (23).

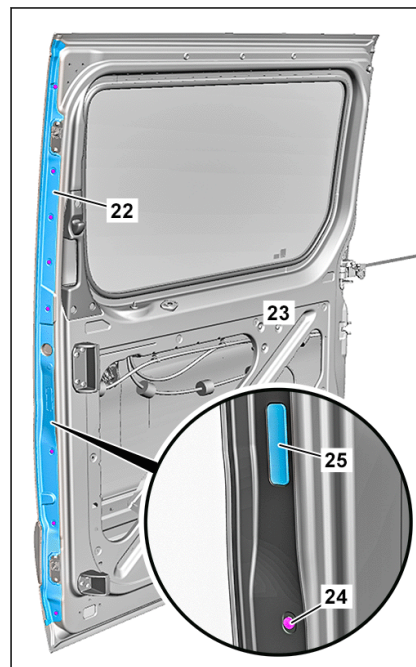

D72.16-A053-73

- 12 Clean contact surface of stop plug (26).

- 13 Install stop plug (26) into opening of sliding door (23).



A 110 987 05 44

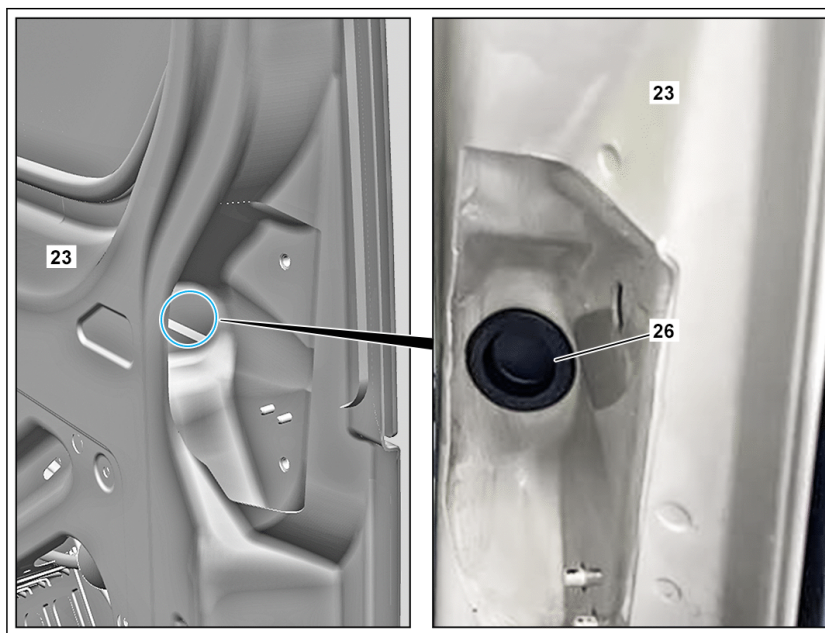

D72.16-A047-76

- 14 Install cover (27) at old position of switch for deactivation of electric sliding door (23).

**i**  
A 906 766 00 97

**i**  
To do so, use screws of switch for deactivation of electric sliding door.



D72.16-A048-76

- 15 Remove information label (35) from sliding door.

**i**  
The information label is no longer required.

- 16 Remove adhesive residue from sliding door.

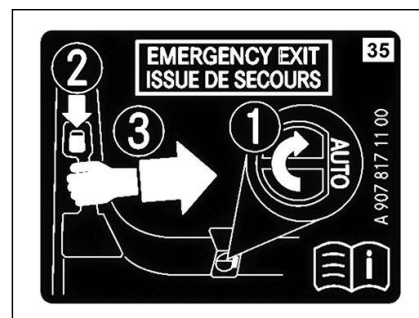

D72.16-A057-01

SM72.16-D-0008-02SGB	Retrofit wiring harness for sliding door (code: VS3SCHIEBT, acc. no.: 72 951 62)		
<b>Notice</b>	Information on preventing damage to electronic components due to electrostatic discharge		AH54.00-P-0001-01A
<b>Notice</b>	Notes on carrying out repair work in the vehicle interior		AH68.00-D-0001-01KOS
<b>WS</b>	000 588 00 84 00 Heat gun		WS54.00-P-0049B
<b>AR</b>	Repairing wiring harness using solder connectors		AR00.19-P-0100-09A
<b>PE</b>	Wiring diagram for sliding door		PE72.16-D-2001LAA

**Model 907.6/7**  
**with code EL9 (Two-way loudspeaker system in front and rear)**  
**with code ZU8 (National version for USA)**

**Headless screws/bolts: screws/bolts and nuts, coarse-pitch thread**

Number	Designation		8.8	10.9
BA00.10-Z-1002-01KOA	M6	Galvanized	Nm 9	13
		Phosphated	Nm 9	12

**Headless screws/bolts: screws/bolts and nuts, coarse-pitch thread**

Number	Designation		12.9
BA00.10-Z-1002-01KOA	M6	Galvanized	Nm 16
		Phosphated	Nm 14

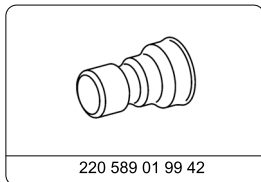

Adapter

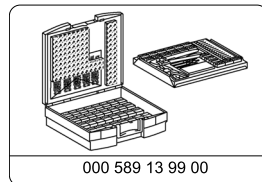

Wiring harness repair kit, basic

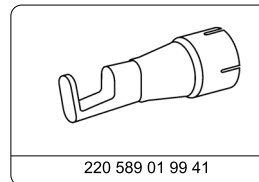

Reflector



Do not kink any electric lines and ensure that they are routed without any chafing.

This prevents any damage.

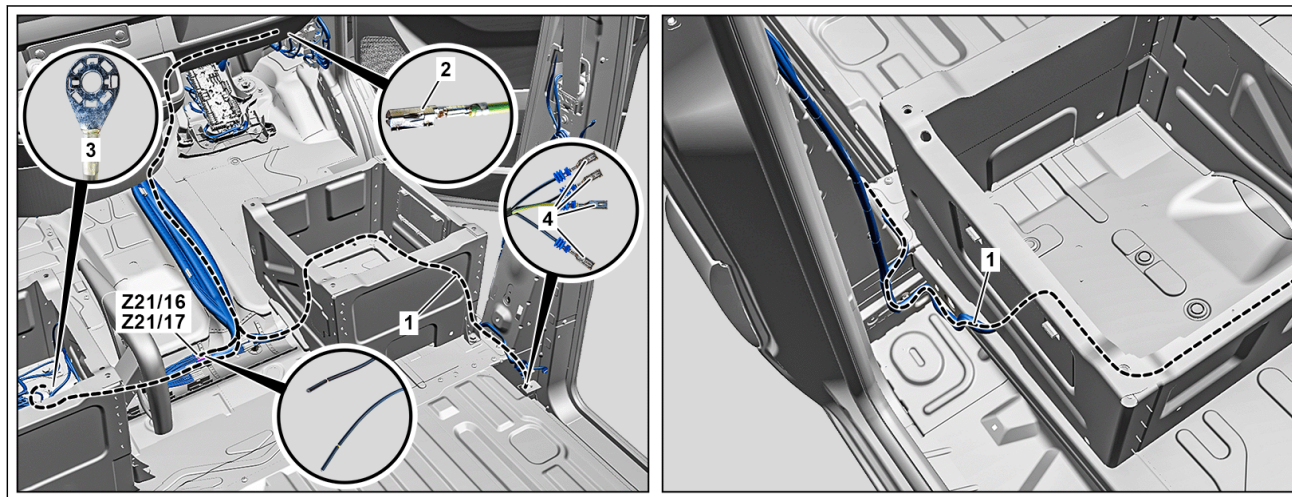

D72.16-A060-78

### Route electrical wiring harness (1)



The following specified line colors for the electric lines correspond to the series production configuration.

- 1 Route electric lines "YE/GN", "BN", "BU/BK", as shown.
- 2 Join electric lines "YE/GN", "BN", "BU/BK", "BU/BN" and wrap, section-by-section, with suitable insulation tape.



The electrical wiring harness (1) is made up of the electric lines "YE/GN", "BN", "BU/BK", "BU/BN".





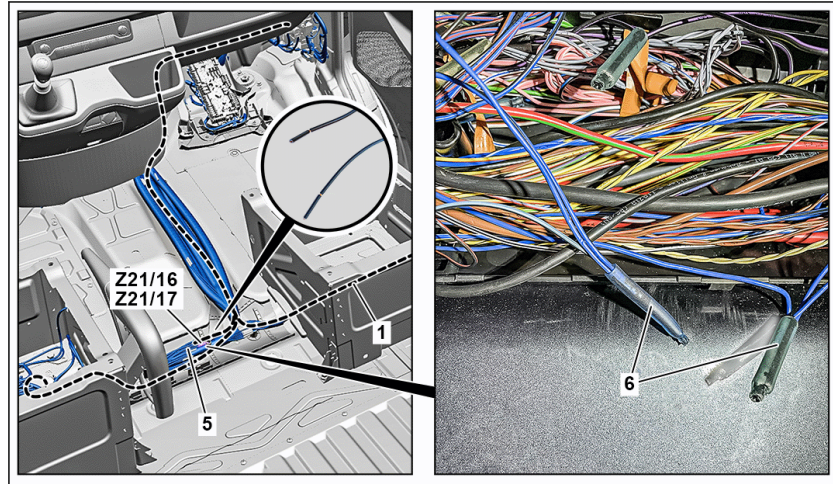

Make sure that the junctions of the electric lines "YE/GN", "BN", "BU/BK", "BU/BN" remain free at the connection end.

- 3 Loosely fasten electrical wiring harness (1) in sections at factory-installed electrical wiring harness or at a suitable position using cable ties.

### Electrical wiring harness (1) to end sleeves



D72.16-A038-75

- |   |  |   |  |
|---|--|---|--|
| 4 | <p>Disconnect control circuit 1 central locking end sleeve (Z21/16) from electrical wiring harness (5).</p> <p><b>i</b><br/>Electric line "BU/BK".</p>   | 6 | <p>Disconnect control circuit 1 central locking end sleeve (Z21/17) from electrical wiring harness (5).</p> <p><b>i</b><br/>Electric line "BU/BN".</p>   |
| 5 | <p>Connect electric line "BU/BK" of electrical wiring harness (5) and electric line "BU/BK" of electrical wiring harness (1) to new end sleeve (6).</p> <p><b>i</b><br/>To do so, use heat gun with  reflector or  adapter.<br/> Use basic wiring harness repair kit.</p> | 7 | <p>Connect electric line "BU/BN" of electrical wiring harness (5) and electric line "BU/BN" of electrical wiring harness (1) to new end sleeve (6).</p> <p><b>i</b><br/>To do so, use heat gun with  reflector or  adapter.<br/> Use basic wiring harness repair kit.</p> |

**Electrical wiring harness (1) to signal acquisition and actuation module (SAM) control unit**

- 8 Release and disconnect electrical connector (RBA1) from SAM (N10).

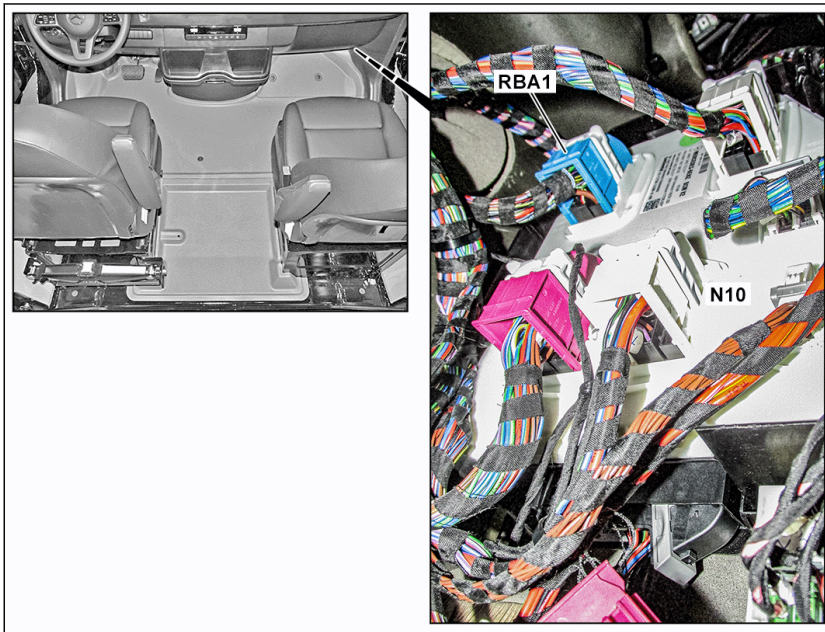

D72.16-A039-76

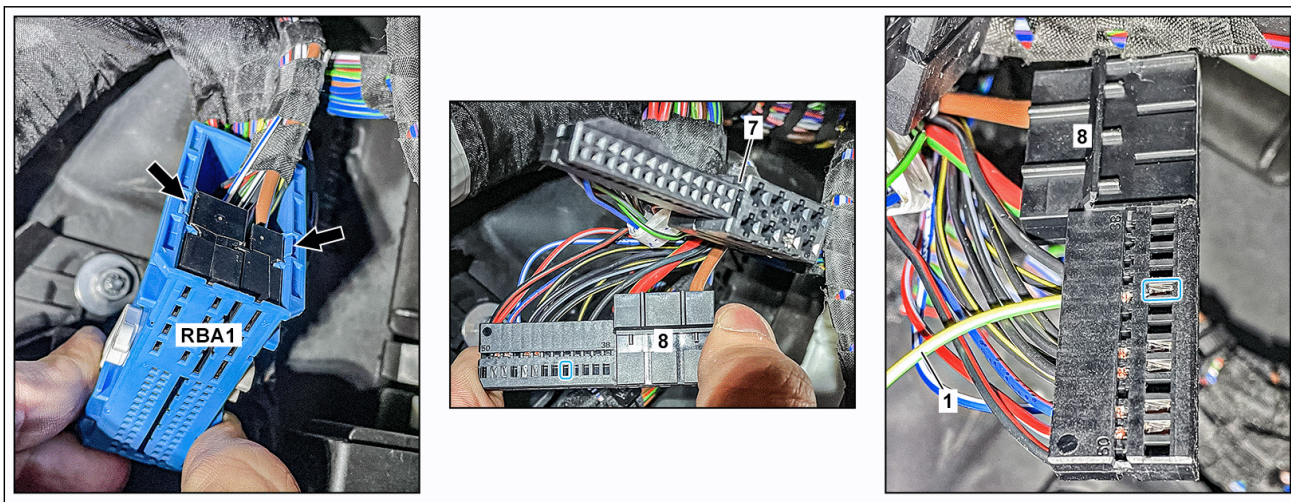

D72.16-A040-78

- 9 Disassemble electrical connector (RBA1).  
 ⓘ  
 To do so, release plug housing (arrows A), guide out plugs (7, 8) and disconnect from each other.
- 10 Install electric line "YE/GN" of electrical wiring harness (1) into contact cavity 42 of plug (8).
- 11 Assemble electrical connector (RBA1).  
 ⓘ  
 To do so, connect plugs (7, 8) and guide into plug housing, then lock.
- 12 Use cable ties to fasten electric line "YE/GN" directly behind plug housing of electrical connector (RBA1) to factory-installed electrical wiring harness.



13 Strap down extended length of electric line "YE/GN" at suitable point.

14 Connect electrical connector (RBA1) to SAM control unit (N10).

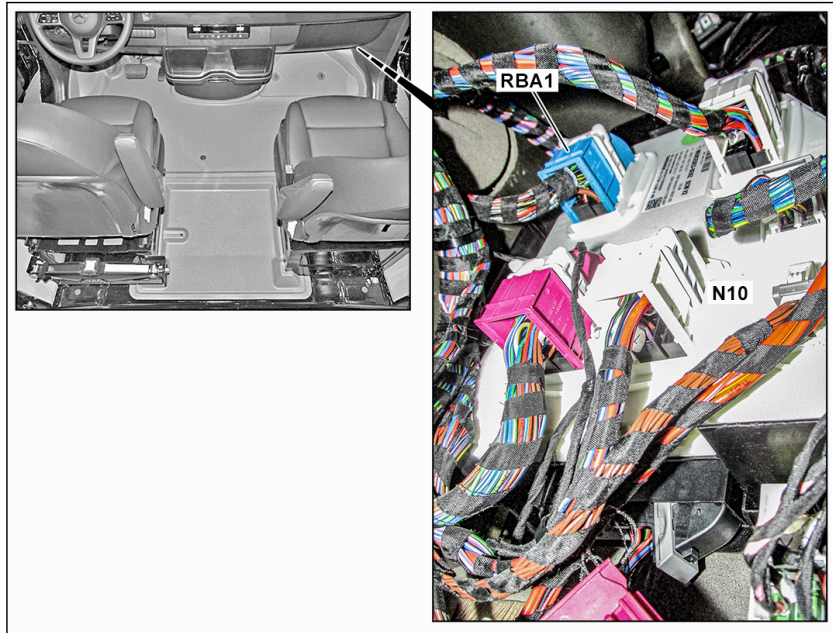

D72.16-A039-76

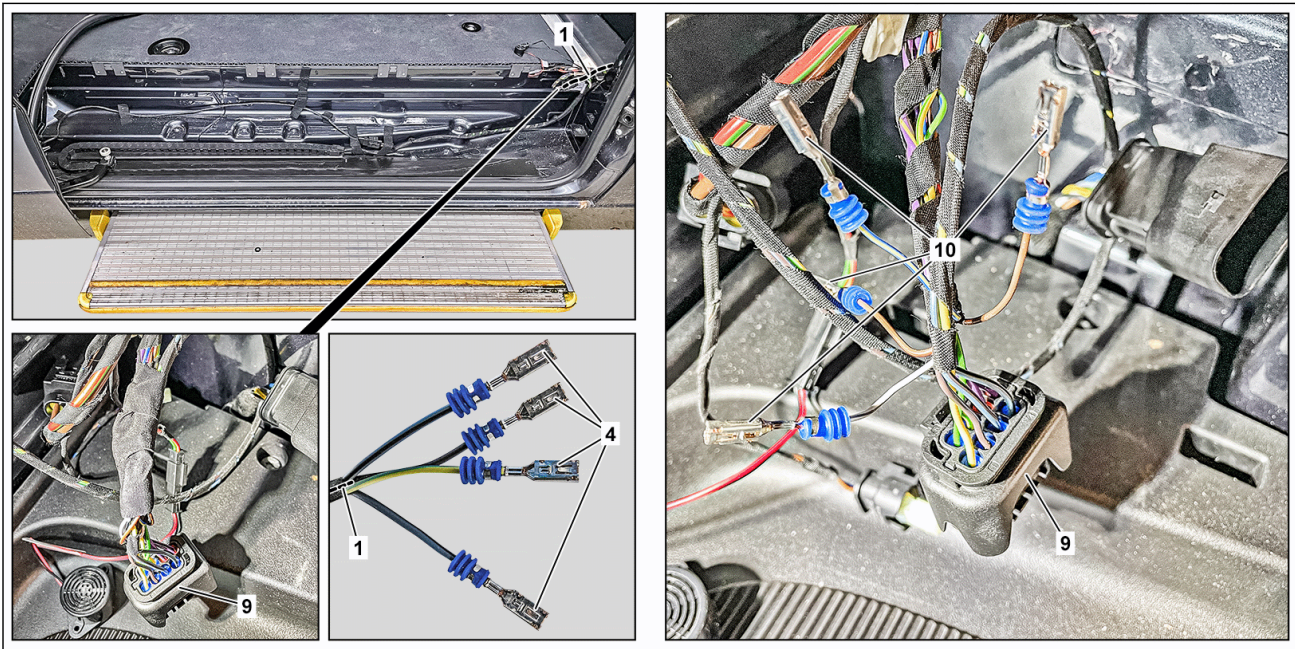

D72.16-A061-79

**Electrical wiring harness (1) to "Right sliding door electrical connector 1 (B-pillar) (X100/11x1)" or "Right**

**sliding door electrical connector 3 (B-pillar)  
(X100/11x3)" (plug (9))**

- 15 Remove contact sockets (10) from contact cavities 1, 2, 3, 4, 7, 8 of plug (9).  
*i*  
 For this purpose,  use basic wiring harness repair kit.
- 16 Use fabric tape to individually insulate removed contact sockets (10).
- 17 Strap down removed contact sockets (10) at suitable point using cable tie.
- 19 Connect plug (9) to plug (11).

- 18 Install contact sockets (4) in plug (9).  
*i*  
 Contact cavity 1: Electric line **"YE/GN"**  
 Contact cavity 2: Electric line **"BN"**  
 Contact cavity 3: Electric line **BU/BN**  
 Contact cavity 4: Electric line **"BU/BK"**  
 Contact cavity 5: Electric line **"VT/YE"**  
 Contact cavity 6: Electric line **"VT/BK"**

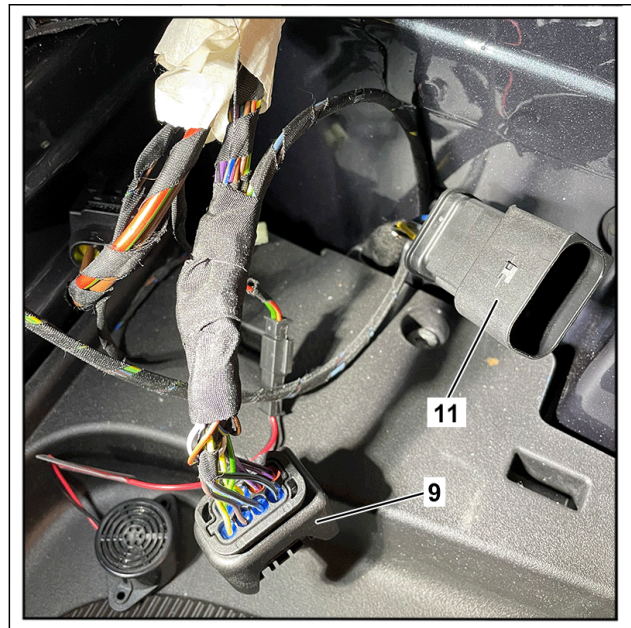

D72.16-A062-82

- 20 Remove plug connector (51) from closing assist motor electrical wiring harness (8).
- i**  
For this purpose, **S** use basic wiring harness repair kit.
- 21 Install blind plugs (9) into plug connector (51).
- 22 Reinstall plug connector (51) on factory-installed electrical wiring harness.

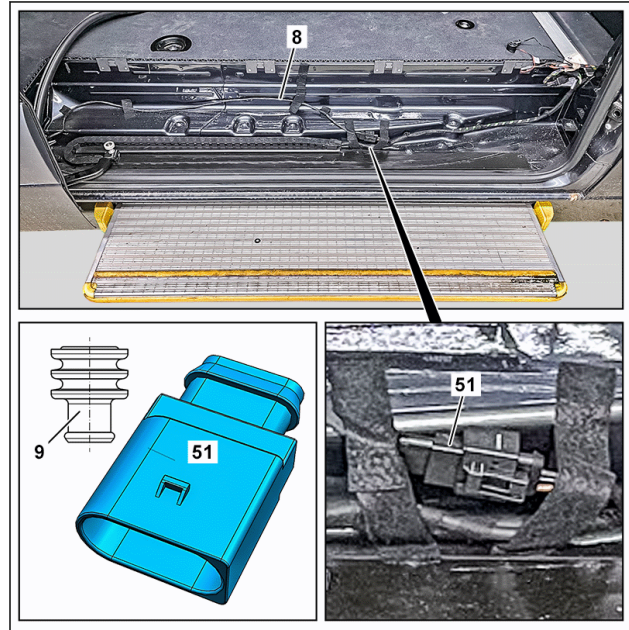

D72.16-A082-82

#### Electrical wiring harness (1) to ground connection

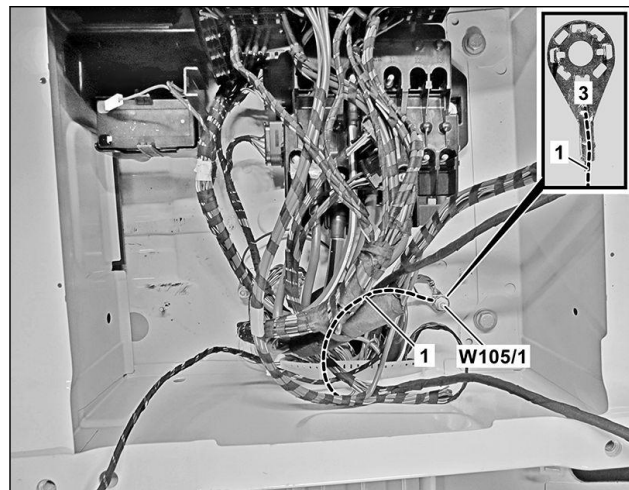

D72.16-A042-11

- 23 Remove nut of driver seat base ground point 1 (W105/1).
- 24 Connect cable lug (3) of electrical wiring harness (1) to driver seat base ground point 1 (W105/1).
- 25 Attach nut of driver seat base ground point 1 (W105/1) **Nm**.

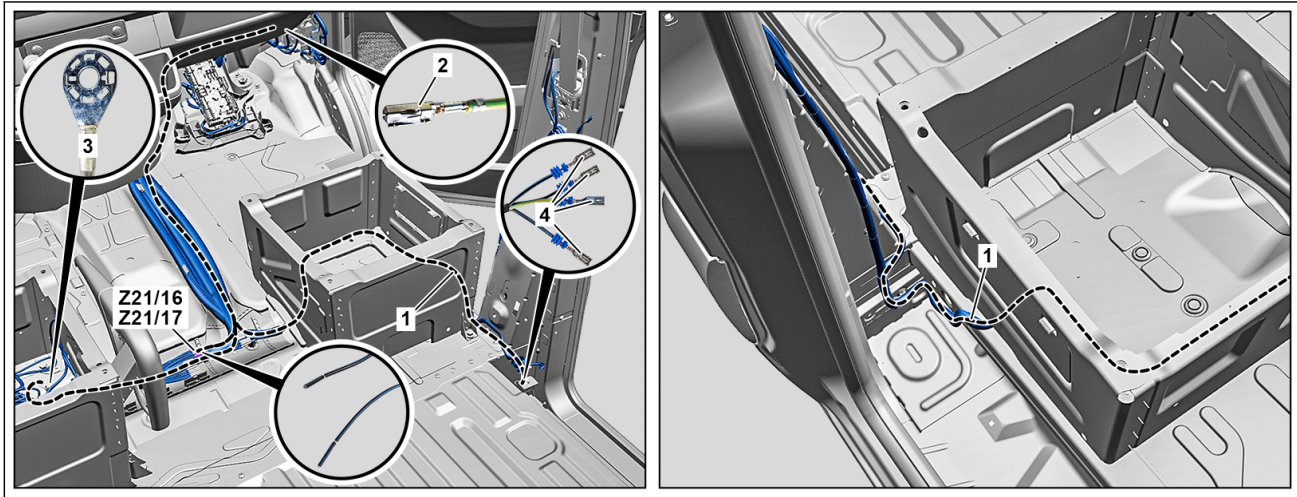

D72.16-A060-78

### Tighten electrical wiring harness (1)

- 26 Tighten loosely attached cable ties on complete electrical wiring harness (1).  
If necessary,

↓  
Strap down extended length of electrical wiring harness (1) at a suitable point.

SM72.16-D-0008-03SG	Fabricate wiring harness for sliding door (code: VS3SCHIEBT, acc. no.: 72 951 62)		
Notice	Information on preventing damage to electronic components due to electrostatic discharge		AH54.00-P-0001-01A
Notice	Notes on carrying out repair work in the vehicle interior		AH68.00-D-0001-01KOS
Notice	Notes on retrofitting electrical/optical lines		AH82.00-P-0000-01A
PE	Wiring diagram for sliding door		PE72.16-D-2001LAA

**Model 907.6/7**  
**with code ZU8 (National version for USA)**

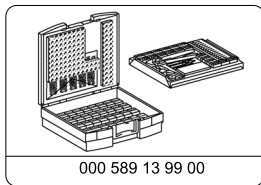



Wiring harness repair  
kit, basic

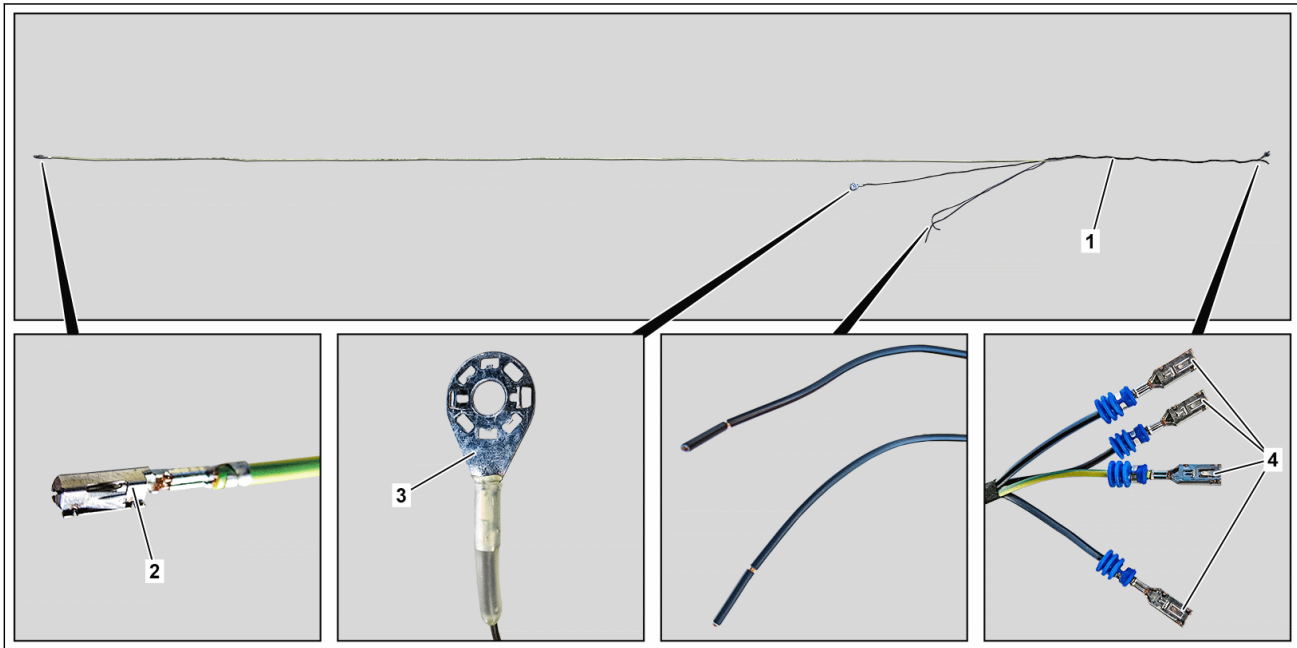

The following specified line colors for the electric lines correspond to the series production configuration and they can be replaced, if necessary, with similar line colors. Please ensure that electrical lines can be correctly assigned in accordance with slot assignment.



D72.16-A036-79

- |  |   |
|--|---|
| <p>1 Prepare electric line "YE/GN".</p> <p><b>i</b></p> <p>X100/1 to RBA1<br/>Line color "YE/GN"<br/>Length approx. 410 cm<br/>Cross section 0.5 mm<sup>2</sup></p>    | <p><b>i</b></p> <p>X100/1 to Z21/17<br/>Line color "BU/BN"<br/>Length approx. 232 cm<br/>Cross section 0.75 mm<sup>2</sup></p>  |
| <p>2 Prepare electric line "BN".</p> <p><b>i</b></p> <p>X100/1 to W105/1<br/>Line color "BN"<br/>Length approx. 255 cm<br/>Cross section 0.5 mm<sup>2</sup></p>        | <p>5 Crimp contact socket (2) onto electric line "YE/GN".</p> <p><b>i</b></p> <p> Use basic wiring harness repair kit.</p> <p><b>i</b></p> <p>A 013 545 76 26 Contact socket</p> |
| <p>3 Prepare electric line "BU/BK".</p> <p><b>i</b></p> <p>X100/1 to Z21/16<br/>Line color "BU/BK"<br/>Length approx. 232 cm<br/>Cross section 0.75 mm<sup>2</sup></p> | <p>6 Crimp cable lug (3) onto electric line "BN".</p> <p><b>i</b></p> <p> Use basic wiring harness repair kit.</p> <p><b>i</b></p> <p>A 001 982 57 02 Cable lug</p>              |
| <p>4 Prepare electric line "BU/BN".</p>  | <p>7 Crimp contact sockets (4) on one side onto electric lines "YE/GN", "BN", "BU/BK", "BN/BN".</p> <p><b>i</b></p> <p> Use basic wiring harness repair kit.</p>                 |



A 009 545 81 26 Contact socket

A 001 545 78 80 Seal

- 8 Attach note in online vehicle data card under field organization texts to KG72. If line colors of prepared wiring harness (1) deviate from series production configuration.



**Note:**

Line colors of retrofitted wiring harness for sliding door deviate from series production configuration.

SM72.16-D-0008-04SG	Retrofit reinforcement for lock striker in C-pillar (code: VS3SCHIEBT, acc. no.: 72 951 62)		
---------------------	---	--	--

**Model 907.6/7**  
**with code ZU8 (National version for USA)**

- 1 Remove reinforcement (38) from C-pillar new part.



To do so, bend reinforcement (38) slightly in upper area (arrow). This makes removal easier.



The new C-pillar part is not required and should be disposed of properly.

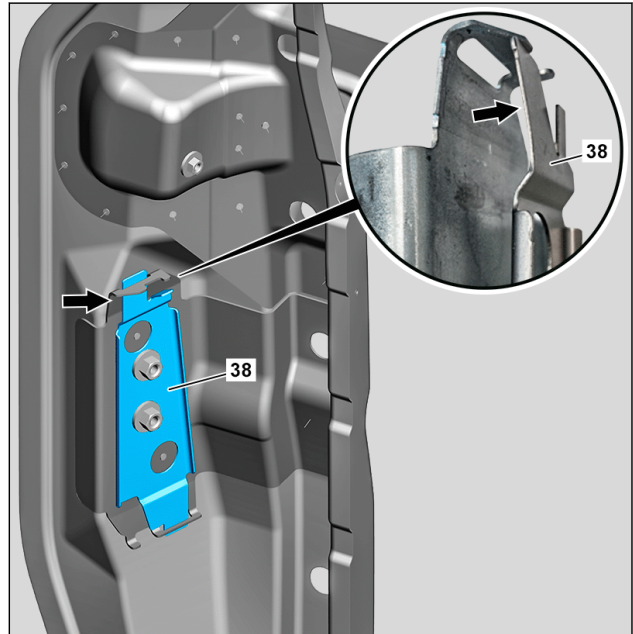

D72.16-A078-82



- 2 Install reinforcement (38) on C-pillar (40).

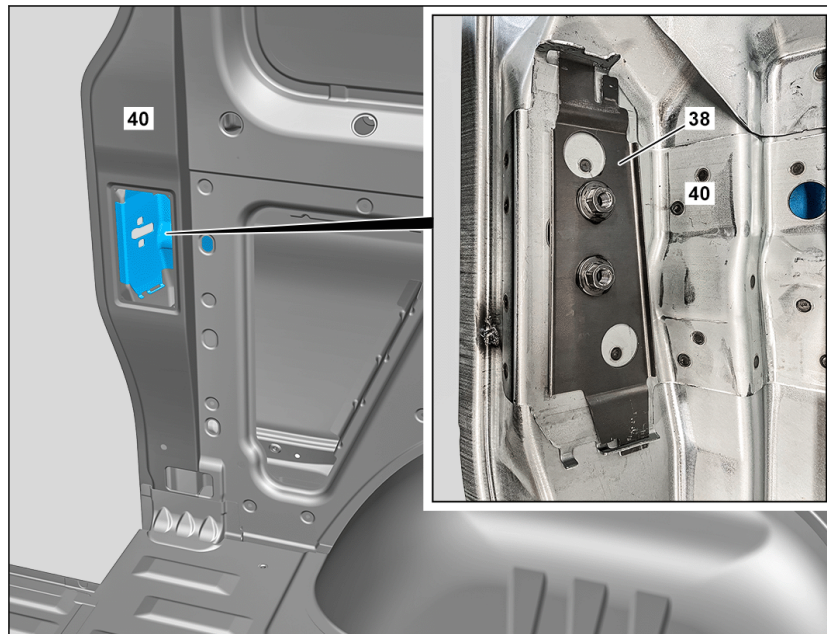

D72.16-A071-76

- 3 Install lock striker (41).



Tighten screws slightly by hand. Screws are tightened when adjusting sliding door.

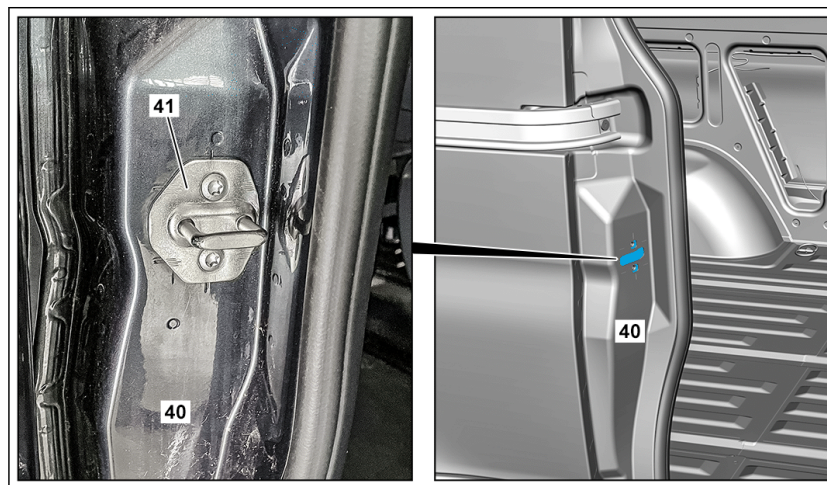

D72.16-A080-75

SM72.16-D-0009SG	Prepare vehicle interior at front for sliding door conversion (code: VS3SCHIEBT, acc. no.: 72 951 62)	18.07.2022
------------------	---	------------

**Model** 907  
with code ZU8 (National version for USA)

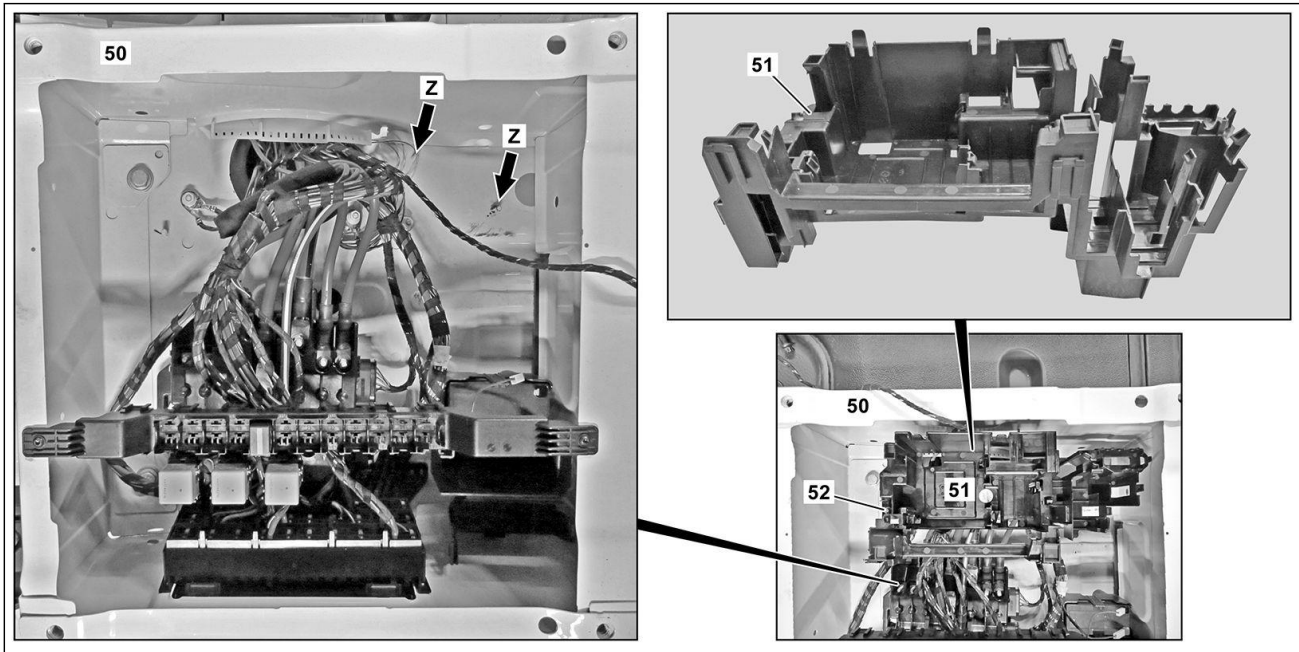

51 Control unit bracket

52 Nut

D54.21-A026-09

**Shown on model 907.7 without S23 (Front passenger bench seat)**

- 10 Cover
- 11 Nuts
- 12 Air duct

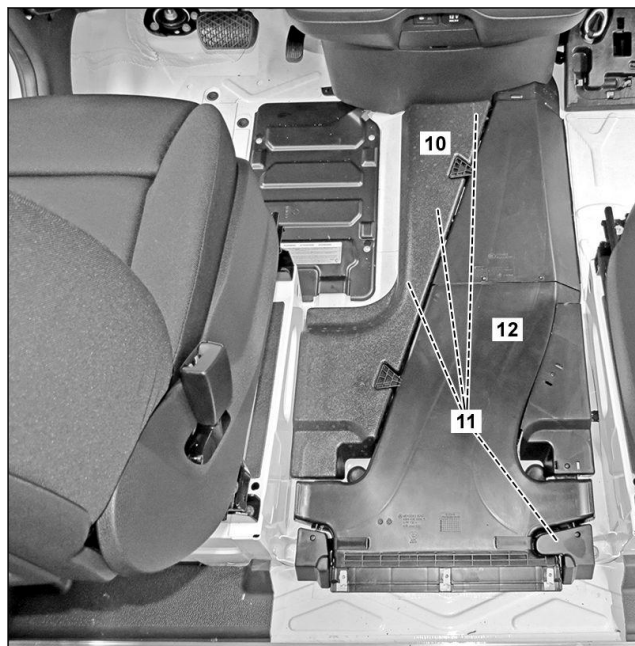





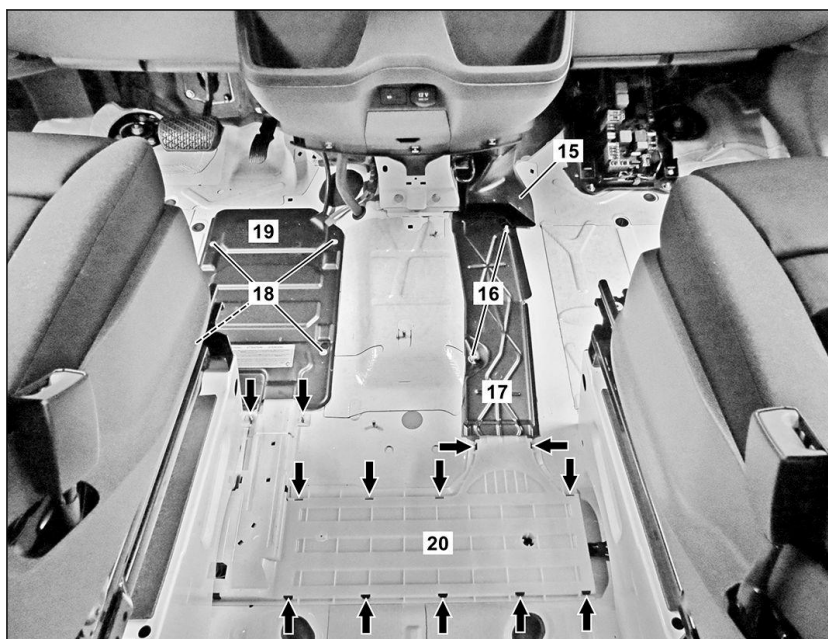

D31.19-1216-12









**Shown on model 907.7 without S23 (Front passenger bench seat)**















- 15 Air duct
- 16 Nuts
- 17 Cable duct
- 18 Bolts
- 19 Battery cover
- 20 Cover



D31.19-1217-06

 <b>Warning</b>	<b>Risk of injury</b> caused by fingers being jammed or pinched when removing, installing or aligning hoods, doors, trunk lid/rear-end door or sliding roof.	No parts of the body or limbs should be within the operating area when the components are moving.	AS00.00-Z-0011-01A
 <b>Caution</b>	<b>Risk of injury</b> caused by scraping or cutting body parts on sharp vehicle parts	Always wear protective gloves when working on or near sharp and non-deburred vehicle parts. Deburr repair panels.	AS00.00-Z-0017-01A
<b>Notice</b>	Information on preventing damage to electronic components due to electrostatic discharge		AH54.00-P-0001-01A
<b>Notice</b>	Notes on carrying out repair work in the vehicle interior		AH68.00-D-0001-01KOS
<b>Notice</b>	Notes on retrofitting electrical/optical lines		AH82.00-P-0000-01A
	<b>Remove</b>		
1.1	Remove driver seat.	Model 907  with code ZU8 (National version for USA)  except code SR8 (Swivel base for driver' seat)	AR91.10-D-1000TS
 <b>AR</b>			
1.2	Remove turn plate with mounted driver's seat.	Model 907  with code SR8 (Swivel base for driver' seat)  with code ZU8 (National version for USA)   Do not separate driver's seat from turn plate.	AR91.10-D-1456TS
 <b>AR</b>			
2	Remove seat base cover from driver's seat.		

3	Remove control unit holder (51).	<p>If control unit holder (51) is installed.</p> <p> To do so, remove nut (52). Position control unit holder (51) so that ground points are accessible. The number of control units varies depending on the vehicle equipment.</p> <p>If control units are installed in control unit holder (51),</p> <p style="text-align: center;">↓</p> <p>unclip control units.</p> <p> Do not disconnect plugs of control units.</p>	
4.1	Remove front passenger seat.	<p>Model 907</p> <p>with code ZU8 (National version for USA)</p> <p>except code SR9 (Swivel base for co-driver' seat)</p>	AR91.10-D-1000TS
 4.2	Remove turn plate with installed front passenger seat.	<p>Model 907</p> <p>with code SR9 (Swivel base for co-driver' seat)</p> <p>with code ZU8 (National version for USA)</p> <p> Do not disconnect front passenger seat from turn plate.</p>	AR91.10-D-1456TS
5	Remove seat base cover of front passenger seat.		
 6	Remove front floor coverings.		AR68.80-D-0006TSR
 7	Remove vehicle tool kit carrier plate.		AR68.30-D-5021TS
 8	Remove lower A-pillar trim on front passenger side.		AR68.30-D-0012TSR
9	Remove cover (10).		
10	Remove air duct (12).	 For this purpose, remove nuts (11).	
11	Remove air duct (15).		

12	Remove cable duct (17).	 To do so, remove nuts (16).	
13	Remove battery cover (19).	 To do so, remove screws (18).	
14	Release cover (20).	 Release cover (20) using a suitable screwdriver (arrows). Release cover (20) until wiring harness can be routed.	
	<b>Install</b>		
15	Install cover (20).		
16	Install battery cover (19).	 To do so, tighten the screws (18).	
17	Install cable duct (17).	 To do so, attach nuts (16).  M6	<a href="#">BA00.10-Z-1002-01KOA</a>
18	Install air duct (15).		
19	Install air duct (12).	 To do this, attach nuts (11).  M6	<a href="#">BA00.10-Z-1002-01KOA</a>
20	Install cover (10).		
21	Install vehicle tool kit carrier plate.		AR68.30-D-5021TS
			
22	Install front floor coverings.		AR68.80-D-0006TSR
			
23	Install lower A-pillar trim on front passenger side.		AR68.30-D-0012TSR
			
24	Attach control unit holder (51).	If control unit holder (51) is installed.  Do not kink subharness during installation of control unit holder (51) and ensure that it is routed free of chafing. This prevents any damage.  To do so, attach nut (52). The number of control units varies depending on the vehicle equipment.  M6 If control units are installed in control unit holder (51), ↓ clip in control units.	<a href="#">BA00.10-Z-1002-01KOA</a>
25	Install seat base cover of driver's seat.		

26.1	Install driver seat.	Model 907  with code ZU8 (National version for USA)  except code SR8 (Swivel base for driver' seat)	AR91.10-D-1000TS
 AR			
26.2	Install turn plate with driver's seat attached.	Model 907  with code SR8 (Swivel base for driver' seat)  with code ZU8 (National version for USA)	AR91.10-D-1456TS
 AR			
27	Install seat base cover of front passenger seat.		
28.1	Install front passenger seat.	Model 907  with code ZU8 (National version for USA)  except code SR9 (Swivel base for co-driver' seat)	AR91.10-D-1000TS
 AR			
28.2	Install turn plate with front passenger seat attached.	Model 907  with code SR9 (Swivel base for co-driver' seat)  with code ZU8 (National version for USA)	AR91.10-D-1456TS
 AR			

 **Headless screws/bolts: screws/bolts and nuts, coarse-pitch thread**

Number	Designation		8.8	10.9
BA00.10-Z-1002-01KOA	M6	Galvanized	Nm 9	13
		Phosphated	Nm 9	12

 **Headless screws/bolts: screws/bolts and nuts, coarse-pitch thread**

Number	Designation		12.9
BA00.10-Z-1002-01KOA	M6	Galvanized	Nm 16
		Phosphated	Nm 14



Mercedes-Benz

Work instructions

---

**Van**

**Group 72**  
**CODE: VS3SCHIEBT**

**SM72.16-D-0008B**  
**17.11.2022**

**Sliding door conversion (code: VS3SCHIEBT, acc. no.: 72 951 62)**

**Model**     **907.6/7**  
**with code ZU8 (National version for USA)**  
**except code EL9 (Two-way loudspeaker system in front and rear)**  
**with electric actuation of right sliding door**





<b>SM72.16-D-0008B</b>	<b>Sliding door conversion (code: VS3SCHIEBT, acc. no.: 72 951 62)</b>	<b>09.11.2022</b>
------------------------	--	-------------------

**Model**      **907.6/7**  
**with code ZU8 (National version for USA)**  
**except code EL9 (Two-way loudspeaker system in front and rear)**  
**with electric actuation of right sliding door**

**Operation no. of the operation texts or standard texts and flat rates**

<b>Category</b>	<b>Op. no.</b>	<b>Operation text</b>	<b>Time</b>	<b>Damage Code</b>	<b>Code</b>
L	02 0981	Operations: Modify sliding door on vehicle with code T55 and without code EL9/V40	6.6 hrs	72 951 62	VS3SCHIEBT

**Important!**

On the affected vehicles, the sliding door is converted from electrical to mechanical actuation.

**Replacement parts ordering:**

Before ordering the required replacement parts, the special equipment code T55 (Electrical actuation for right sliding door) must be removed from the Vehicle Documentation (VeDoc). Only then can the correct replacement parts can be determined using XENTRY Parts Information.

**Vehicle documentation (VeDoc):**

Changes in VeDoc can only be made by users with write permission.

If no-one with change authorization is available, a ticket must be created in the "XENTRY Support and Feedback (XSF)" system for "Vehicle data/VeDoc".

Please note that the XSF ticket has to be approved by the national organization, something which involves additional processing time.

It may take a few days for the entry to be visible in VeDoc.

**In the event of problems:**

If problems arise while carrying out the service measure, please create a PTSS case.

To do this, use the "DTS pre-case checklist".

The most recent version is always available via the XENTRY Portal.



D72.16-A045-08

**Shown on vehicle with automatic transmission**

- 1 Stowage compartment
- 2 Switches
- 3 Connector
- 4 Cover



D72.16-A044-72

**Shown on vehicle with code T74  
(Grab handle for entrance)**

- 5 B-pillar paneling
- 6 Switches
- 7 Connector



D72.16-A043-76

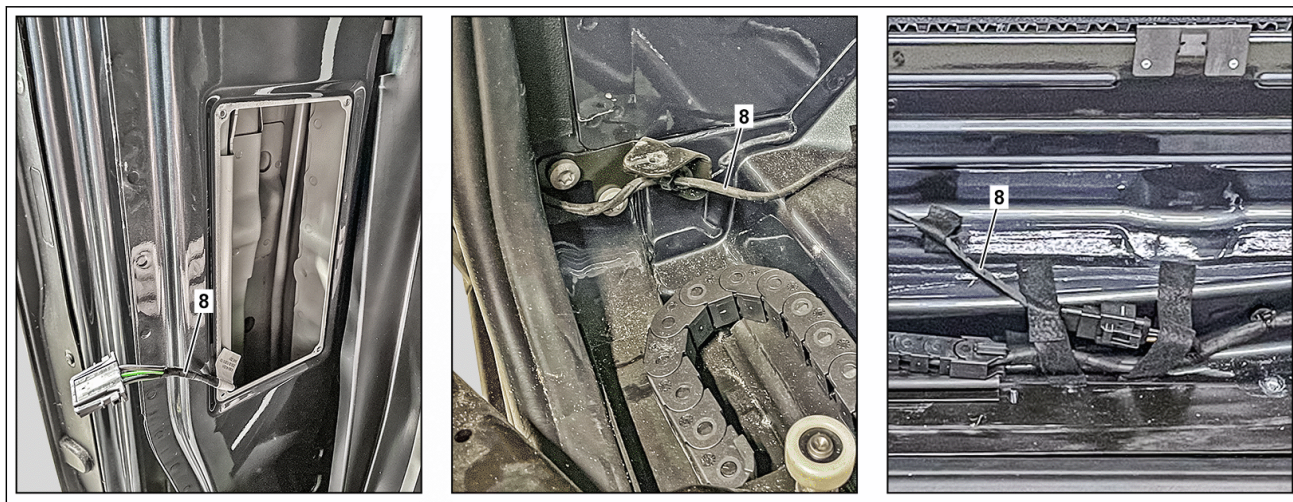

D72.16-A051-78

- 8 Closing assist motor electrical wiring harness

- 9 Blind plug
- 13 Connector
- 14 Connector

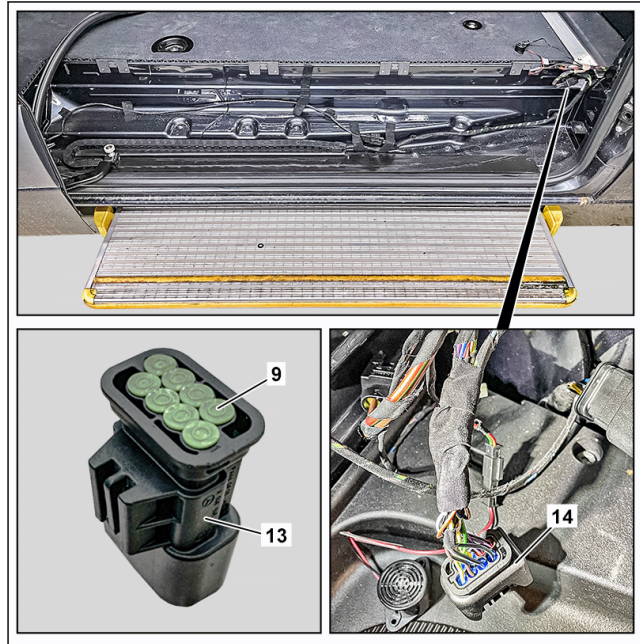





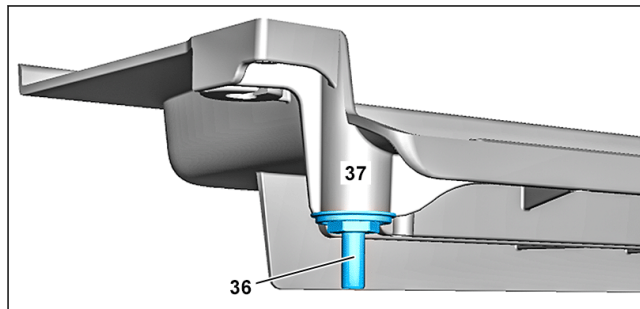

D72.16-A046-82













- 36 Retaining bolt
- 37 Guide rail









D72.16-A058-80

<b>Warning</b>	<b>Risk of injury</b> caused by fingers being jammed or pinched when removing, installing or aligning hoods, doors, trunk lid/rear-end door or sliding roof.	No parts of the body or limbs should be within the operating area when the components are moving.	AS00.00-Z-0011-01A
<b>Caution</b>	<b>Risk of injury</b> caused by scraping or cutting body parts on sharp vehicle parts	Always wear protective gloves when working on or near sharp and non-deburred vehicle parts. Deburr repair panels.	AS00.00-Z-0017-01A
<b>Notice</b>	Information on preventing damage to electronic components due to electrostatic discharge		AH54.00-P-0001-01A
<b>Notice</b>	Notes on carrying out repair work in the vehicle interior		AH68.00-D-0001-01KOS
<b>Notice</b>	Notes on retrofitting electrical/optical lines		AH82.00-P-0000-01A













	<b>Check</b>		
1	Check if vehicle is affected by measure.	 For authorized Mercedes-Benz service partners, only the entry in the Extended VEGA Application (EVA) system, in the "Current" tab, is decisive. There is no need to also check the affected vehicles in the workshop information system (WIS) or vehicle list.	
	<b>Update Vehicle Documentation (VeDoc)</b>		
2	Remove special equipment from online vehicle data card.	 Remove existing code T55 (Electrical actuation for right sliding door).	
3	Attach "Sliding door converted as per SM72.16-D-0008B note" under field organization texts to KG72.		
	<b>Remove</b>		
4	Detach ground line of on-board electrical system battery.		AR54.10-D-0029TS
5	Remove component parts in vehicle interior for sliding door conversion.		<a href="#">Page 31</a>
6	Remove stowage compartment (1) with switch (2) for electric sliding door.	 The stowage compartment (1) and switch (2) are no longer required. <b>Information on wiring diagram:</b> Right stowage compartment sliding door pushbutton switch (S169/2)	AR68.10-D-1513TS
7	Strap down plug (3) of switch (2) using cable ties on factory-installed electrical wiring harness or at a suitable point.	 The plug (3) is no longer required.	
8	Remove cover(4).	 To do this, unscrew screw/bolts. Cover (4) is no longer required.	

9 	Remove B-pillar trim (5) on front passenger side with switch (6) for electric sliding door.	Model 907.6/7  The B-pillar trim (5) and switch (6) are no longer required. <b>Information on wiring diagram:</b> Right sliding door button (S159/8)	AR68.30-D-4706TS
10	Strap down plug (7) for switch (6) using cable ties on factory-installed electrical wiring harness or at a suitable point.	 The plug (7) is no longer required.	
11 	Remove closing assist motor with lock striker in C-pillar.	 The closing assist motor is no longer required.	AR72.16-D-0002TSR
12 	Remove lower guide rail for sliding door.	Model 907.6/7  The lower carriage is no longer required.	AR72.16-D-7816TS
13	Remove closing assist motor electrical subharness (8).	 To do so, unclip electrical subharness (8), guide it out of C-pillar then disconnect electrical connector.  Electrical subharness (8) is no longer required.  Clip remover	<a href="tel:452589016300">452 589 01 63 00</a>
14 	Remove sliding door.	Model 907.6/7	AR72.16-D-1260TSB
15	Install blind plugs (9) into plug (13).	 A 048 545 42 28 A 000 545 78 80	
16	Connect plug (13) to plug (14).		
17	Strap down plug (14) using cable ties on factory-installed electrical wiring harness or at suitable point.	 The plug (14) is no longer required. <b>Information on wiring diagram:</b> Right sliding door electrical connector 2 (B-pillar) (100/11x2)	

	<b>Modify sliding door</b>		
18 ✚AR	Remove switch for deactivation of electric sliding door.	 The switch is no longer required.	AR72.16-D-0003TSR
19 ✚AR	Remove motor for electric sliding door with cable.	 The engine and cable are no longer required.	AR72.29-D-5901TS
20 ✚AR	Remove electric sliding door control unit.	 The control unit is no longer required.	AR72.29-D-5898TS
21 ✚AR	Remove anti-entrapment strip for electric sliding door.		AR72.29-D-5890TS
22 ✚AR	Remove center carriage for sliding door.	Model 907.6/7	AR72.16-D-2230TSB
23 ✚AR	Remove the lock for the sliding door.	Model 907.6/7	AR72.16-D-4035TSB
24 ✚AR	Install new sliding door lock.	Model 907.6/7  Install outside door handle cable only. Do not attach remaining cables.	AR72.16-D-4035TS
25	Modify electrical wiring harness in sliding door.		<a href="#">Page 11</a>
26 ✚AR	Remove door handle.	 Only remove door handle far enough to gain access to cables.	AR72.16-D-6601TS
27	Modify cables in sliding door.	 Operation steps 3 to 9 of document reference.	<a href="#">Page 11</a>
28	Modify sliding door detachable parts.	 Operation steps 10 to 23 of the document reference.	<a href="#">Page 11</a>



29	Install new center sliding carriage of sliding door.	Model 907.6/7	AR72.16-D-2230TS
AR			
	<b>Retrofit wiring harness in vehicle interior</b>		
30	Fabricate wiring harness for sliding door. Wiring diagram for sliding door	Wiring harness repair kit, basic	PE72.16-D-2001LAA <a href="#">Page 26</a> <a href="#">000 589 13 99 00</a>
PE			
31	Retrofit wiring harness for sliding door. 000 588 00 84 00 Heat gun Repairing wiring harness using solder connectors Wiring diagram for sliding door	Reflector Adapter Wiring harness repair kit, basic	WS54.00-P-0049B AR00.19-P-0100-09A PE72.16-D-2001LAA <a href="#">Page 19</a> <a href="#">220 589 01 99 41</a> <a href="#">220 589 01 99 42</a> <a href="#">000 589 13 99 00</a>
WS AR PE			
	<b>Install</b>		
32	Attach new retaining bolt (36) to new lower guide rail (37).	20 Nm	
33	Install new lower sliding door carriage.	Model 907.6/7	AR72.16-D-7844TS
AR			
34	Install new lower guide rail (37).		AR72.16-D-7816TS
AR			
35	Retrofit reinforcement for lock striker in C-pillar.		<a href="#">Page 29</a>
36	Install sliding door.	Model 907.6/7	AR72.16-D-1260TS
AR			
37	Adjust sliding door.		AR72.16-D-1023TS
AR			
38	Install new B-pillar trim on front passenger side.	Model 907.6/7	AR68.30-D-4706TS
AR			
39	Install new lower center stowage compartment on instrument panel.		AR68.10-D-1513TS
AR			
40	Install removed component parts in vehicle interior for sliding door conversion.		<a href="#">Page 31</a>
41	Connect ground line of on-board electrical system battery.		AR54.10-D-0029TS
AR			

	SCN coding		
42 	Connect diagnostic system.	 It is absolutely essential to precisely follow the operation steps as described in the vehicle diagnosis system.	AD00.00-D-2000-06TS
43 	Connect charging equipment.	 During the entire work procedure a sufficiently large voltage supply must be provided for the vehicle's on-board electrical system. Otherwise any undervoltage that occurs may damage the control units.  Follow the operating instructions for the charger.  Use the charger to ensure that an adequate power supply (min. 12.5 V) is provided for the on-board electrical system battery.	AR54.10-D-1127TS
44 	Perform SCN coding on signal acquisition and actuation module (SAM) control unit.	 Under the "Control unit adaptations" menu item, follow the instructions for "SCN coding".	AR54.21-D-0015TS
45 	Remove charger from vehicle.		AR54.10-D-1127TS
	<b>Check</b>		
46	Check sliding door for correct opening and closing.	 See Operator's Manual.	
47	Perform key function test.	 See Operator's Manual.	

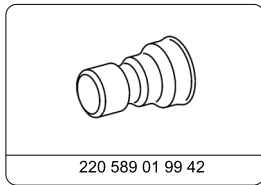

Adapter

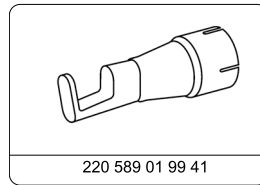

Reflector

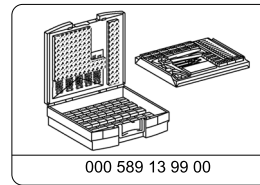
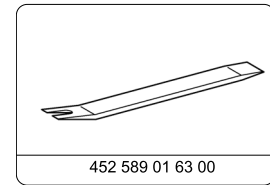
Wiring harness repair  
kit, basic

Clip remover

**Parts ordering note**

Part no.	Designation	Quantity
A 906 630 33 00	C-pillar	1
A 910 763 01 00	Sliding base in center	1
N 000000 001152	Screw	2
A 906 720 02 04	Lock striker	1
A 000 984 31 29	Screw	2
A 910 730 39 00	Door lock (bottom)	1
A 907 730 41 00	Door lock (top)	1
N 000000 001145	Screw	2
A 906 733 00 14	Bracket	1
A 907 730 42 00	Cable	1
A 910 760 15 00	Cable	1
A 910 760 16 00	Cable	1
A 000 995 51 14	Line fastener	5
N 000000 000455	Screw	2
A 000 763 01 47	Sliding base bottom	1
A 907 760 37 00	Cable	1
A 910 683 18 00	Stowage tray	1
A 906 691 01 33 9051	Cap	1
A 907 631 02 00	Bracket	1
A 907 690 38 00 9051	Right sliding door B-pillar trim, grab handle	1
A 906 692 12 22 9051	Cover (on vehicle with code V36 Roof lining)	2
A 906 692 07 22 9051	Cover	1
A 910 998 02 50 9051	Cover plug	n. B.
A 910 998 00 50 9051	Cover plug	n. B.
A 037 545 35 28	Plug-in connector	1
A 048 545 42 28	Connector	1
A 000 545 78 80	Blind plug	12
A 100 987 05 44	Plug	1
A 906 766 00 97	Cover	1
	Parts for electrical wiring harness:	
	Electric lines (available on free market, observe specifications)	4
A 005 545 58 26	Female contact	1
A 001 982 57 02	Cable lug (ground connection)	1
A 009 545 81 26	Female contact	4
A 000 995 25 94	Cable tie	n. B.

SM72.16-D-0008-01SGA	Convert sliding door (code: VS3SCHIEBT, acc. no.: 72 951 62)		
----------------------	--	--	--

**Model 907.6/7**  
**with code ZU8 (National version for USA)**  
**except code EL9 (Two-way loudspeaker system in front and rear)**  
**with electric actuation of right sliding door**

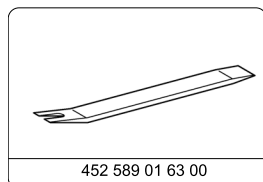

452 589 01 63 00

Clip remover

**Repair materials**

Number	Designation	Order number
BR00.45-Z-1025-04A	Cleaner	A 005 989 19 71

**Refit electrical wiring harness**

**Shown on model 907.7 with code EL9 (2-way speaker system, front and rear)**

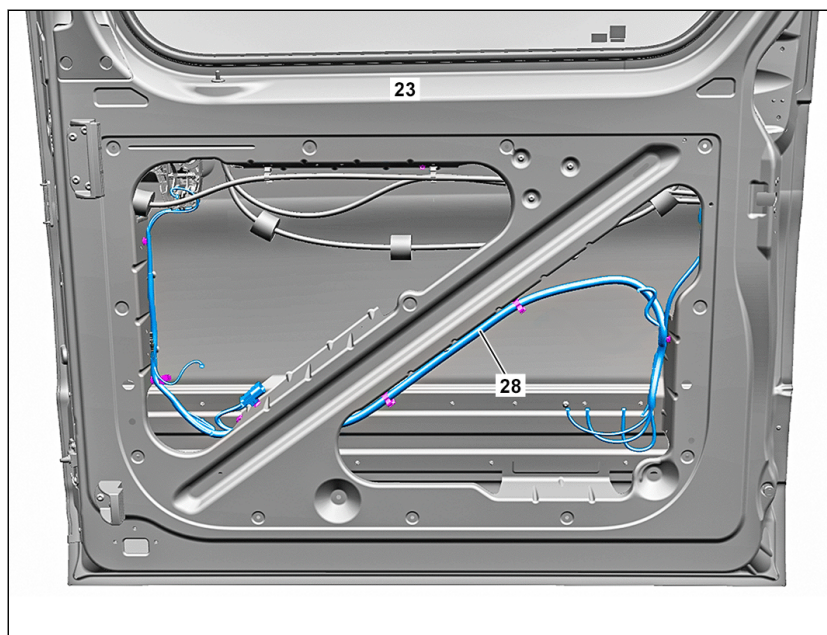

D72.16-A049-76

- 1 Remove electrical wiring harness (28).



To do so, unclip electrical wiring harness (28) from sliding door (23).

The number of fastenings can vary here, depending on the equipment installed.



The electrical wiring harness (28) is no longer required.

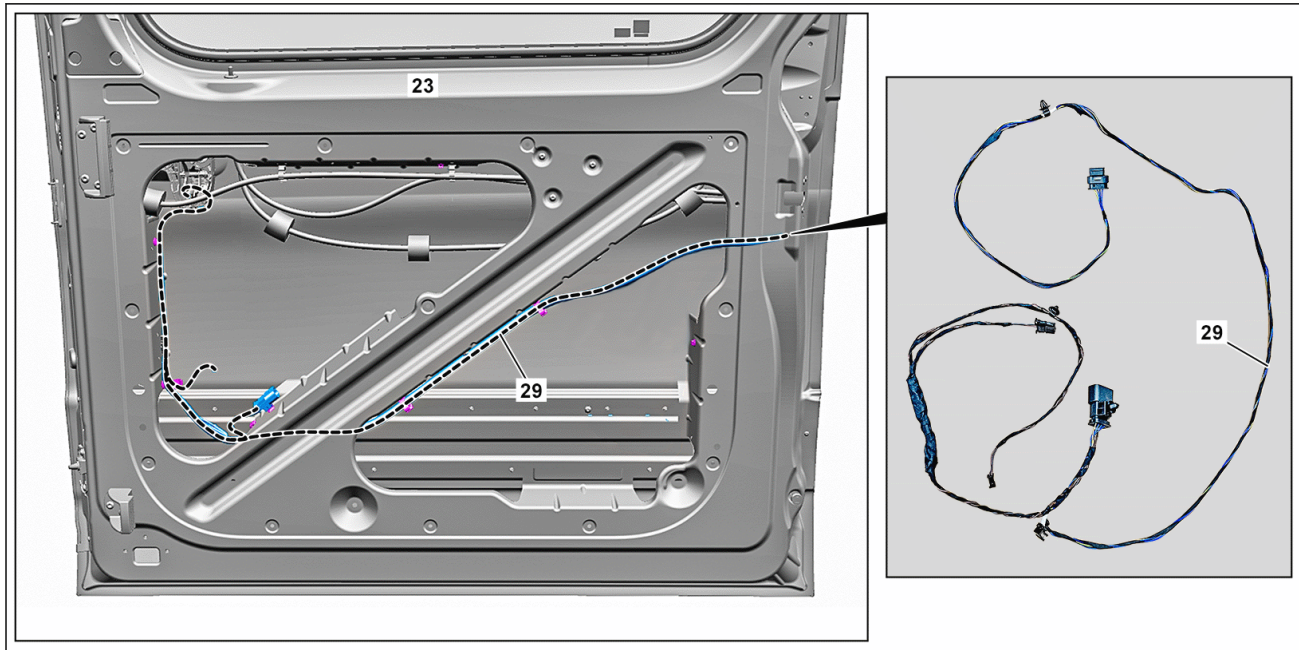

D72.16-A050-79

**Shown on model 907.7 with code EL9 (2-way speaker system, front and rear)**

- 2 Install new electrical wiring harness (29) as shown.



Order part number for electrical wiring harness (29) according to list below.



Continue in the higher-level service document.

-----

**Refit cables**

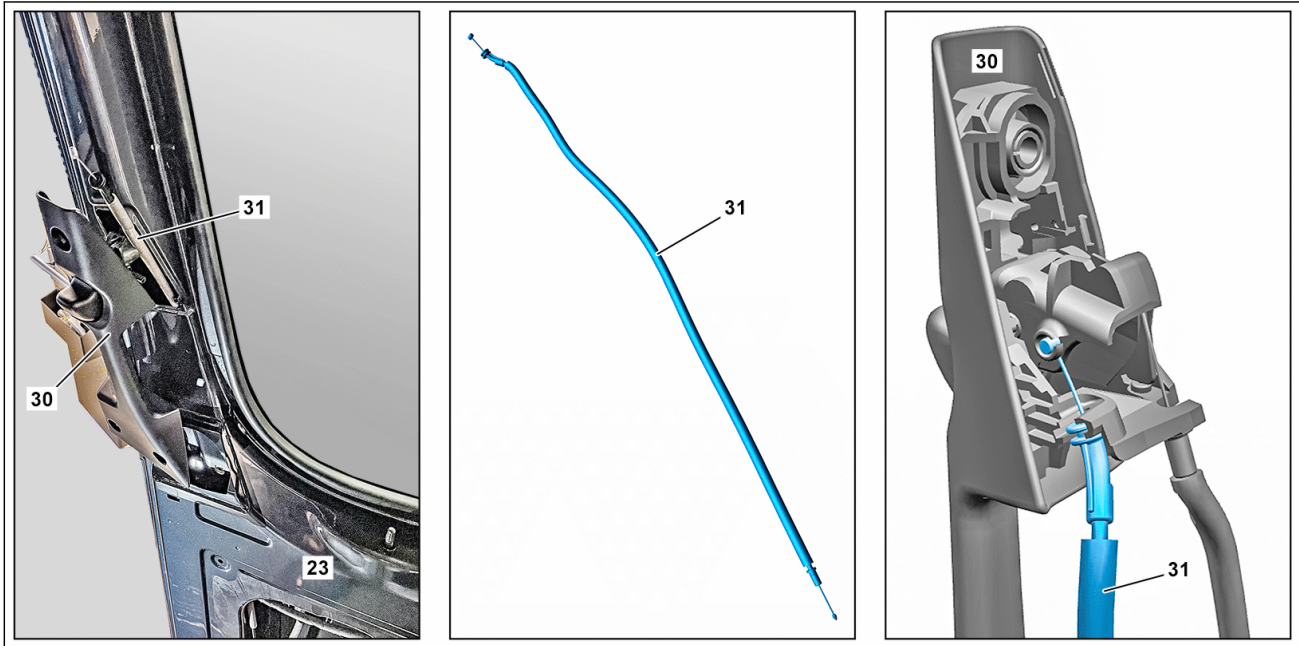

D72.16-A054-79

- 3 Route cable (31) through sliding door (23) to door handle (30).  
 ⓘ  
 Handle cables carefully and do not kink them.  
 Damage may occur otherwise.

ⓘ  
 A 910 760 16 00

- 4 Install cable (31) in door handle (30).

- 5 Route cable (32) into sliding door (23).  
 ⓘ  
 A 907 760 37 00

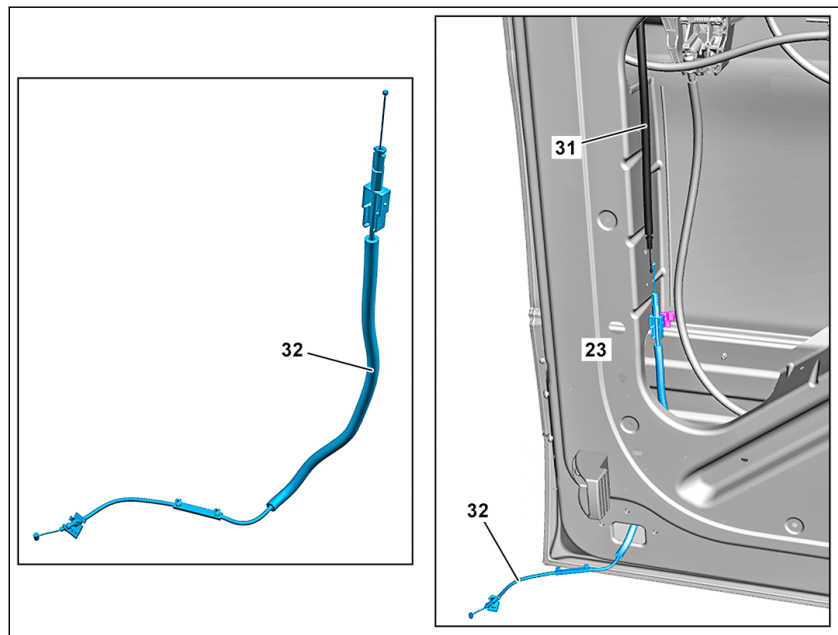

D72.16-A055-76

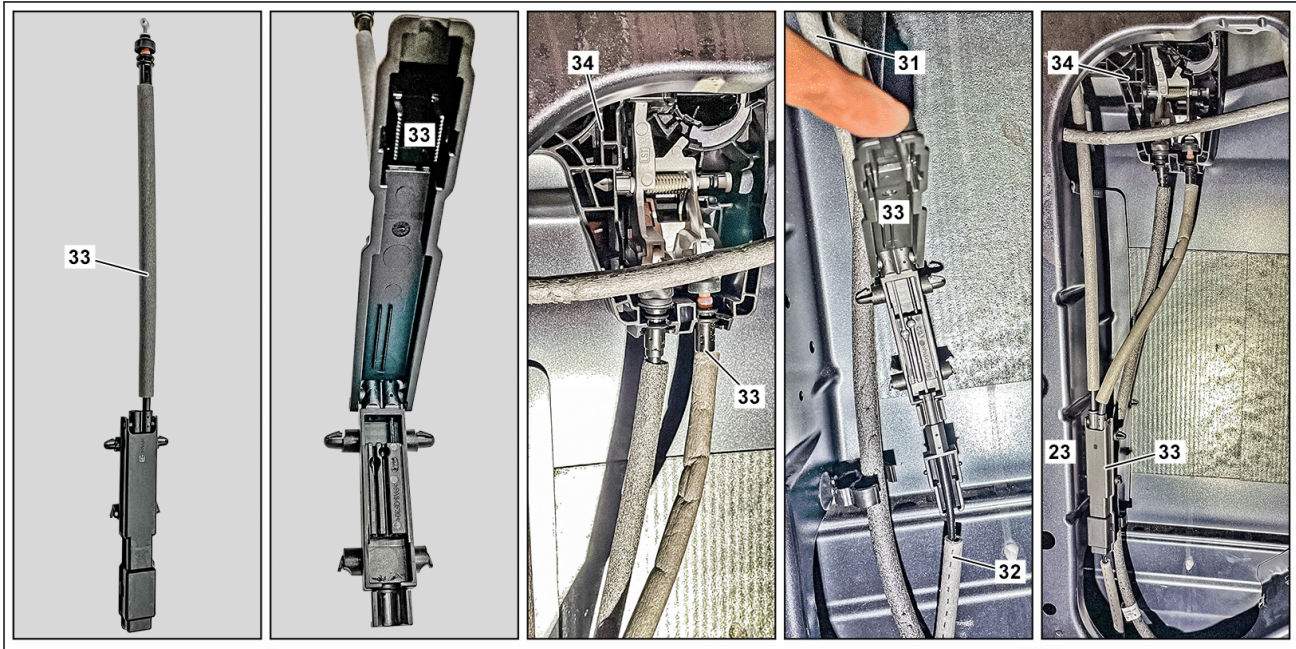

D72.16-A056-79

- 6 Open cable (33).  
i  
 A 910 760 15 00
- 7 Install cable (33) in bearing bracket (34).
- 8 Install cable (31) and cable (32) in cable (33).
- 9 Close cable (33) and clip into sliding door (23).  
i  
 Continue in the higher-level service document.

**Modify sliding door detachable parts**

- 10 Remove anti-entrapment strip (21) from trim (22).  
i  
 To do so, remove anti-entrapment strip (21) using clip remover then remove adhesive tape.  
i  
 The anti-entrapment strip (21) is no longer required.

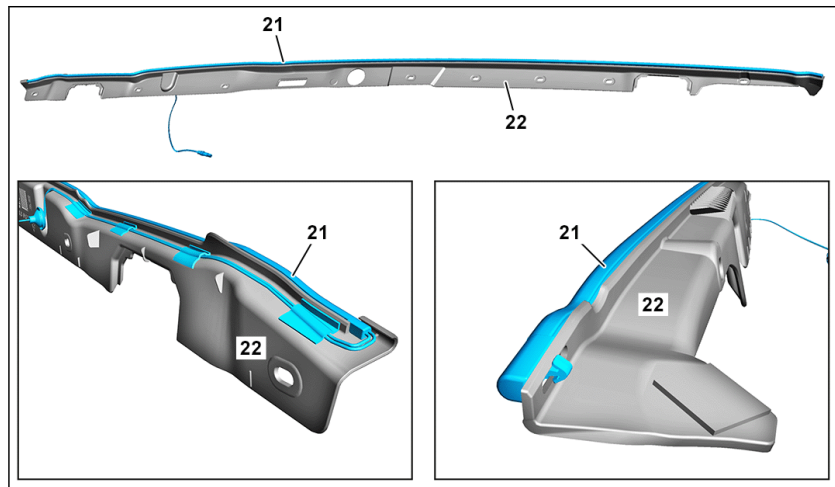

D72.16-A052-75

11 Clean contact surface of stop plug (26).

12 Install stop plug (26) into opening of sliding door (23).



A 110 987 05 44

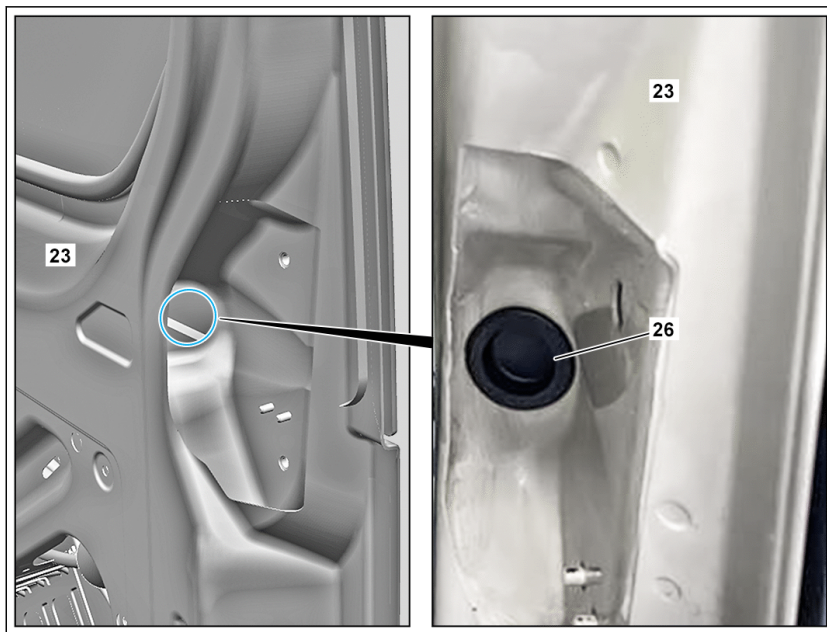

D72.16-A047-76

13 Install cover (27) at old position of switch for deactivation of electric sliding door (23).



A 907 766 00 97



To do so, use screws of switch for deactivation of electric sliding door.



D72.16-A048-76



- 14 Remove information label (35) from sliding door (23).



The information label is no longer required.

- 15 Remove adhesive residue from sliding door (23).

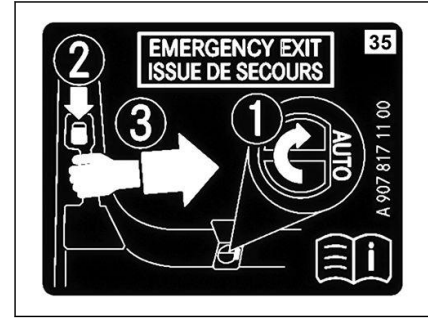

D72.16-A057-01

- 16 Attach trim (22) to sliding door (23).



To do so, install 2 expansion rivets (24) to fix trim (22) in place.

- 17 Drill holes (arrows) with  $\varnothing$  5 mm on trim (22).



The holes (arrows) must line up with those in the sliding door (23).

- 18 Remove trim (22).



To do this, remove expansion rivets (24).

- 19 Remove drilling chips.

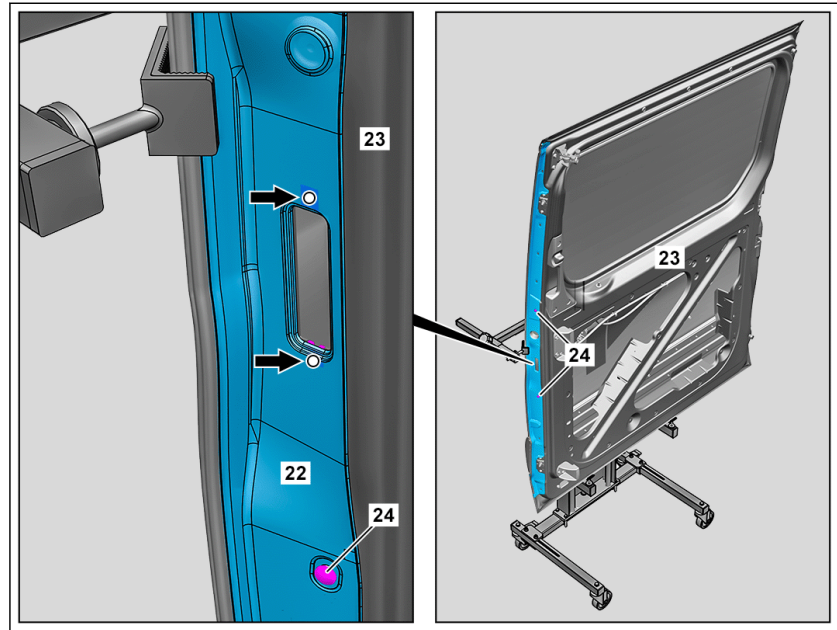

D72.16-A076-76

- 20 Attach spring lock nuts (50).

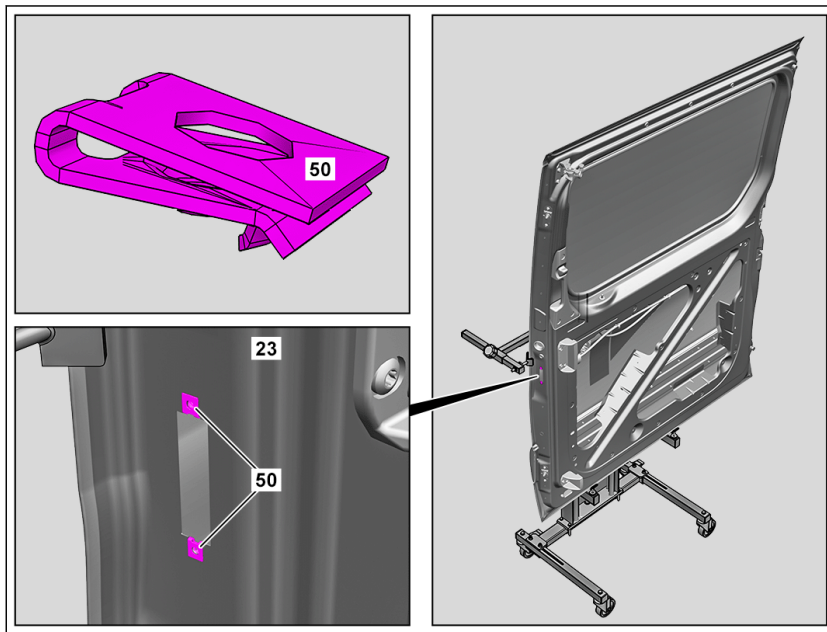

D72.16-A075-76

- 21 Install trim (22) on sliding door (23).



To do so, install expansion rivet (24).



Trim (25) is no longer required.

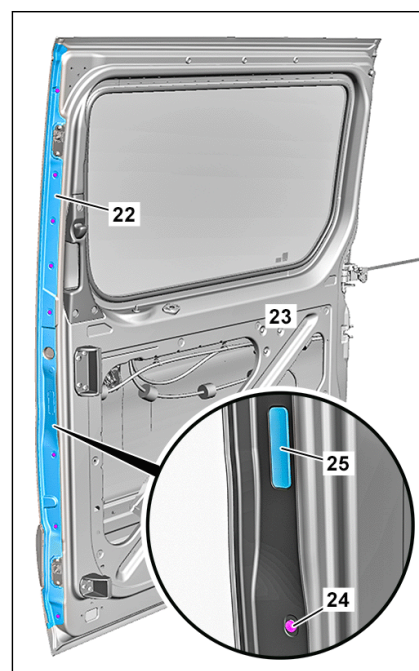

D72.16-A053-73

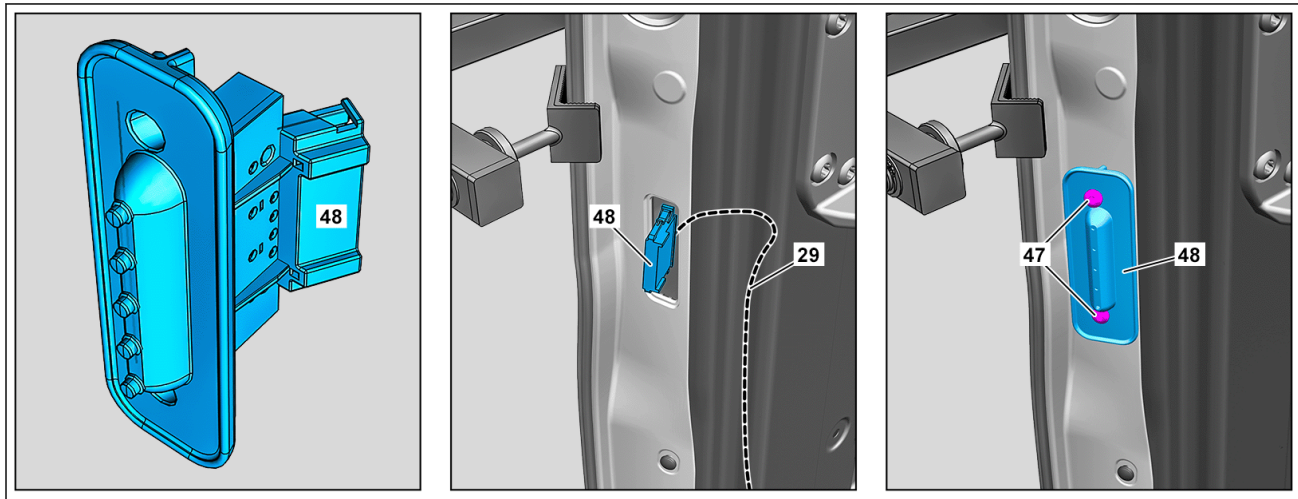



D72.16-A077-78

- 22 Connect contact switch (48) to plug connector (49) of new electrical wiring harness (29).



To do so, turn in screws (47).

- 23 Install contact switch (48).

SM72.16-D-0008-02SG	Retrofit wiring harness for sliding door (code: VS3SCHIEBT, acc. no.: 72 951 62)		
<b>Notice</b>	Information on preventing damage to electronic components due to electrostatic discharge		AH54.00-P-0001-01A
<b>Notice</b>	Notes on carrying out repair work in the vehicle interior		AH68.00-D-0001-01KOS
 <b>WS</b>	000 588 00 84 00 Heat gun		WS54.00-P-0049B
 <b>AR</b>	Repairing wiring harness using solder connectors		AR00.19-P-0100-09A
 <b>PE</b>	Wiring diagram for sliding door		PE72.16-D-2001LAA

**Model 907.6/7**  
**with code ZU8 (National version for USA)**  
**except code EL9 (Two-way loudspeaker system in front and rear)**

 **Headless screws/bolts: screws/bolts and nuts, coarse-pitch thread**

Number	Designation		8.8	10.9
BA00.10-Z-1002-01KOA	M6	Galvanized	Nm 9	13
		Phosphated	Nm 9	12

 **Headless screws/bolts: screws/bolts and nuts, coarse-pitch thread**

Number	Designation		12.9
BA00.10-Z-1002-01KOA	M6	Galvanized	Nm 16
		Phosphated	Nm 14

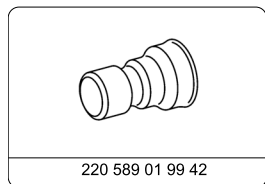

Adapter

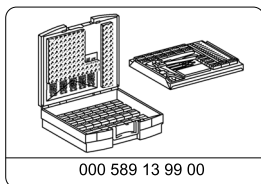

Wiring harness repair kit, basic

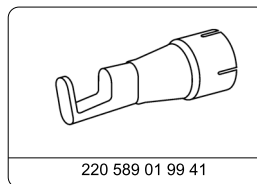

Reflector



Do not kink any electric lines and ensure that they are routed without any chafing.

This prevents any damage.

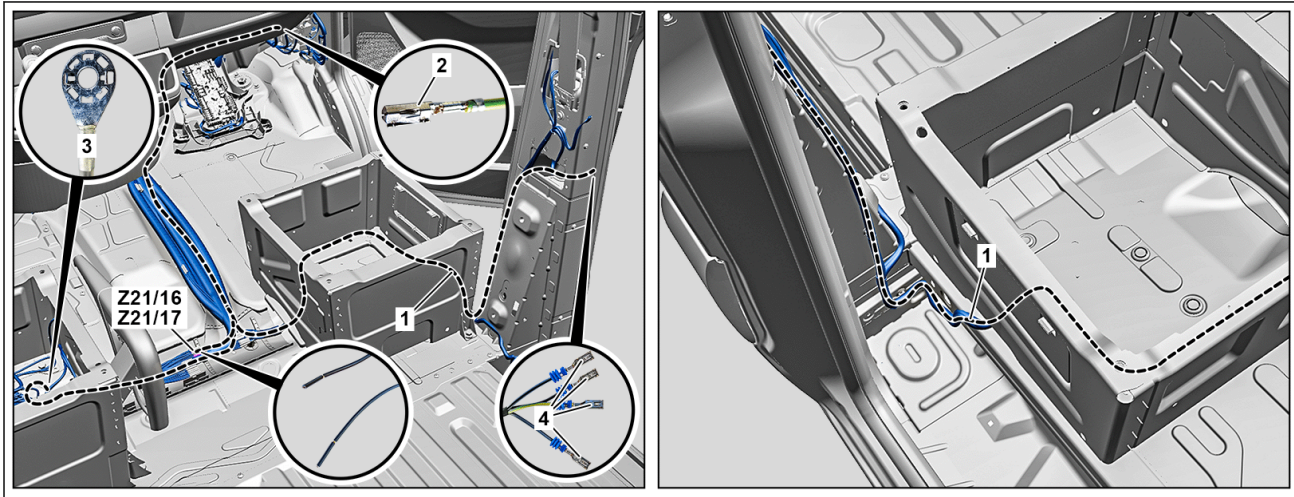

D72.16-A037-78

### Route electrical wiring harness (1)



The following specified line colors for the electric lines correspond to the series production configuration.

- 1 Route electric lines "YE/GN", "BN", "BU/BK", as shown.
- 2 Join electric lines "YE/GN", "BN", "BU/BK", "BU/BN" and wrap, section-by-section, with suitable insulation tape.



The electrical wiring harness (1) is made up of the electric lines "YE/GN", "BN", "BU/BK", "BU/BN".





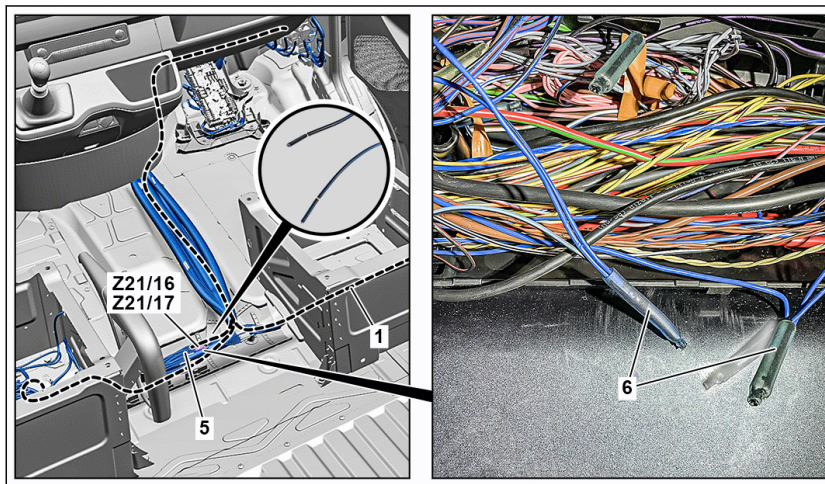

Make sure that the junctions of the electric lines "YE/GN", "BN", "BU/BK", "BU/BN" remain free at the connection end.

- 3 Loosely fasten electrical wiring harness (1) in sections at factory-installed electrical wiring harness or at a suitable position using cable ties.

### Electrical wiring harness (1) to end sleeves



D72.16-A038-75

- |   |  |   |   |
|---|--|---|---|
| 4 | <p>Disconnect control circuit 1 central locking end sleeve (Z21/16) from electrical wiring harness (5).</p> <p><b>i</b><br/>Electric line "BU/BK".</p>   | 6 | <p>Disconnect control circuit 1 central locking end sleeve (Z21/17) from electrical wiring harness (5).</p> <p><b>i</b><br/>Electric line "BU/BN".</p>  |
| 5 | <p>Connect electric line "BU/BK" of electrical wiring harness (5) and electric line "BU/BK" of electrical wiring harness (1) to new end sleeve (6).</p> <p><b>i</b><br/>To do so, use heat gun with  reflector or  adapter.<br/> Use basic wiring harness repair kit.</p> | 7 | <p>Connect electric line "BU/BN" of electrical wiring harness (5) and electric line "BU/BN" of electrical wiring harness (1) to new end sleeve (6).</p> <p><b>i</b><br/>To do so, use heat gun with  reflector or  adapter.<br/> Use basic wiring harness repair kit.</p> |

**Electrical wiring harness (1) to signal acquisition and actuation module (SAM) control unit**

- 8 Release and disconnect electrical connector (RBA1) from SAM (N10).



D72.16-A039-76

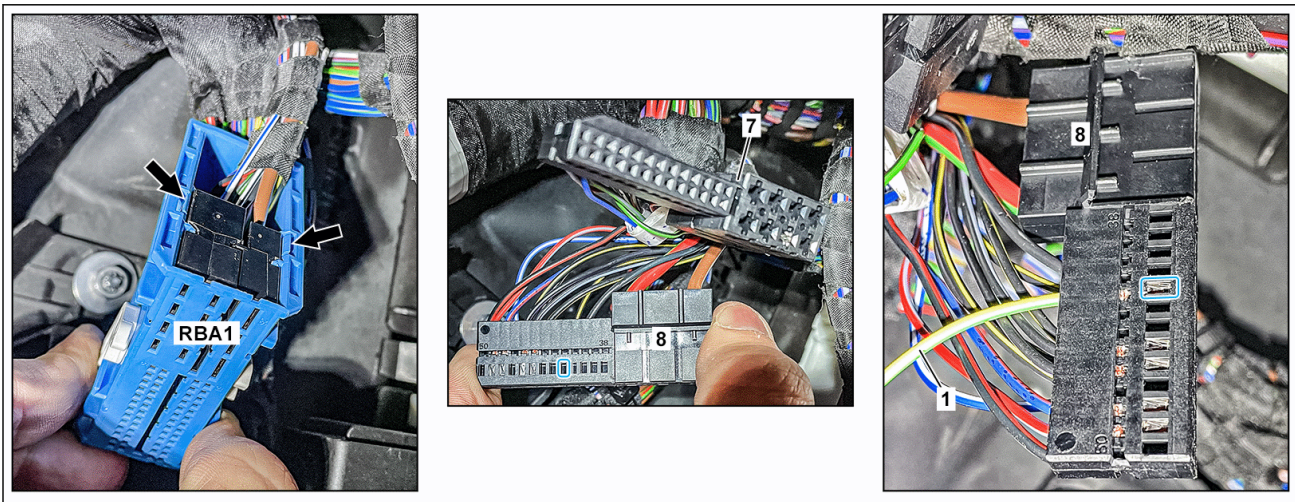

D72.16-A040-78

- |   |   |
|---|---|
| <ul style="list-style-type: none"> <li>9 Disassemble electrical connector (RBA1).<br/><b>i</b><br/>To do so, release plug housing (arrows A), guide out plugs (7, 8) and disconnect from each other.</li> </ul> | <ul style="list-style-type: none"> <li>11 Assemble electrical connector (RBA1).<br/><b>i</b><br/>To do so, connect plugs (7, 8) and guide into plug housing, then lock.</li> </ul>                              |
| <ul style="list-style-type: none"> <li>10 Install electric line "YE/GN" of electrical wiring harness (1) into contact cavity 42 of plug (8).</li> </ul>   | <ul style="list-style-type: none"> <li>12 Use cable ties to fasten electric line "YE/GN" directly behind plug housing of electrical connector (RBA1) to factory-installed electrical wiring harness.</li> </ul> |

13 Strap down extended length of electric line "YE/GN" at suitable point.

14 Connect electrical connector (RBA1) to SAM control unit (N10).

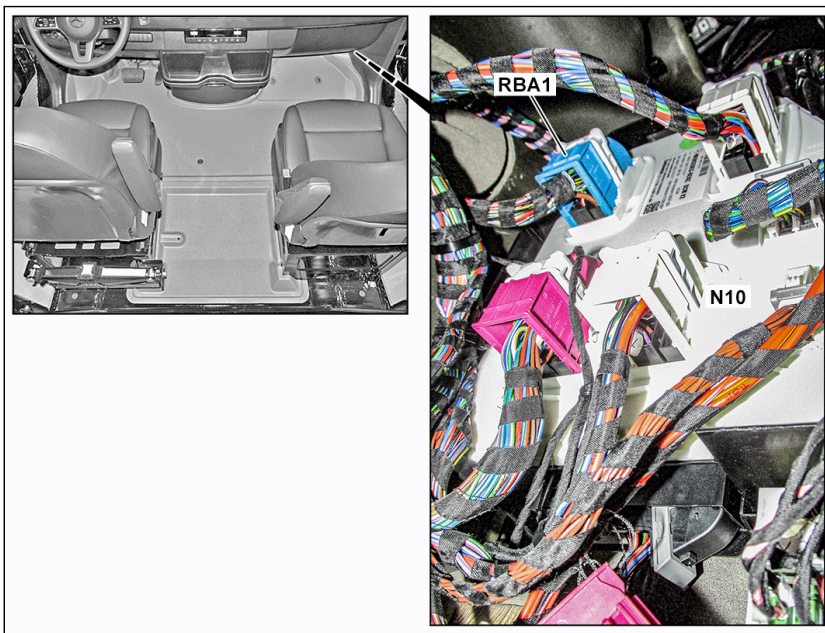

D72.16-A039-76

Electrical wiring harness (1) to "Right sliding door contact plate 1 electrical connector (X100/1)" (plug (9))

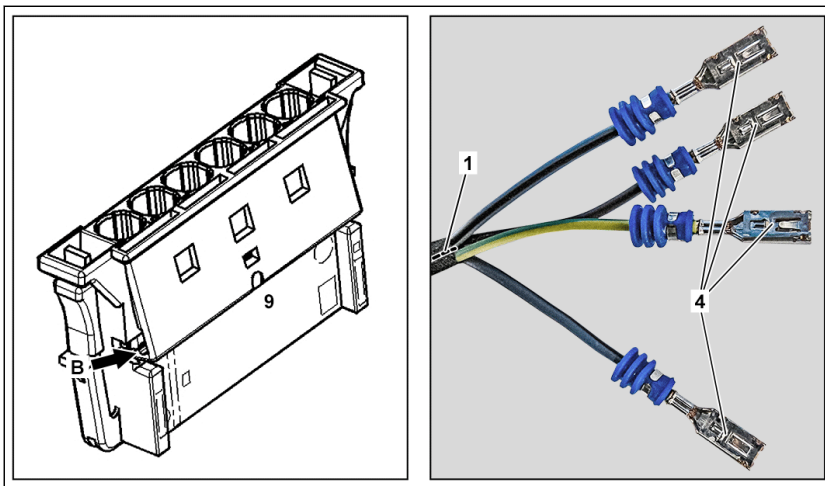

D72.16-A041-75

15 Release plug (9) (arrow B).



A 048 545 42 28 Plug



Contact cavity 1: Electric line "YE/GN"

Contact cavity 3: Electrical line "BN"

Contact cavity 4: Electrical line BU/BN

Contact cavity 5: Electrical line "BU/BK"

16 Install contact sockets (4) in plug (9).



- 17 Lock plug (9).

### Electrical wiring harness (1) to ground connection

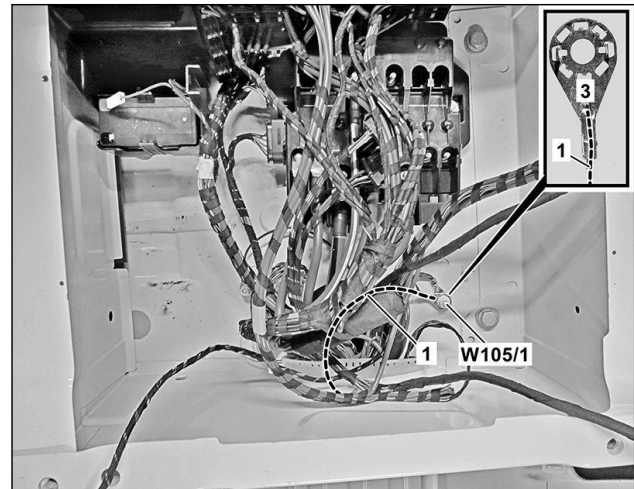

D72.16-A042-11

- 18 Remove nut of driver seat base ground point 1 (W105/1).
- 19 Connect cable lug (3) of electrical wiring harness (1) to driver seat base ground point 1 (W105/1).
- 20 Attach nut of driver seat base ground point 1 (W105/1) [Nm](#).

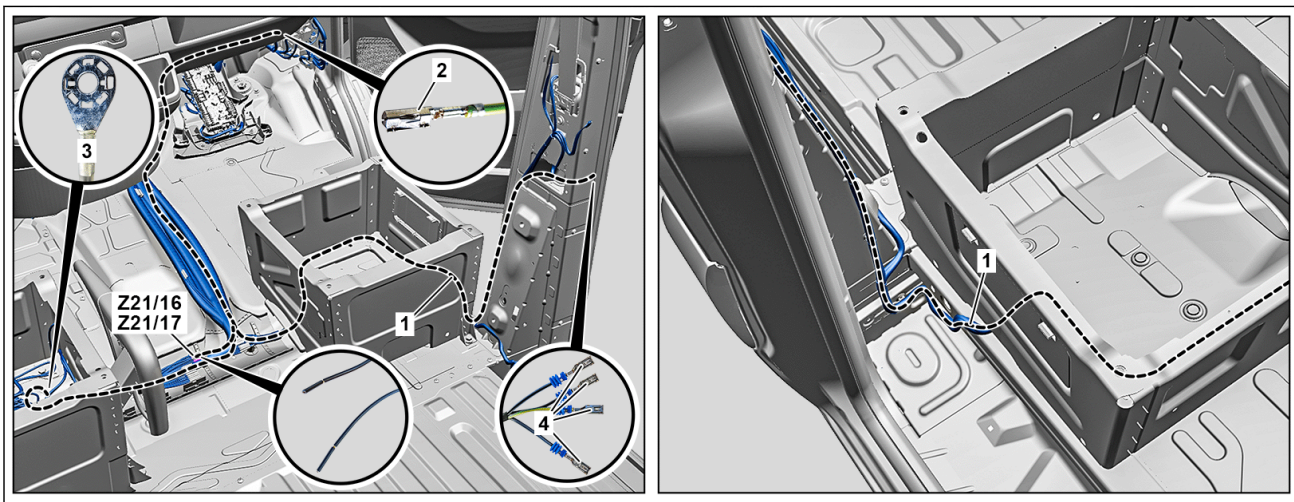

D72.16-A037-78

### Tighten electrical wiring harness (1)

- 21 Tighten loosely attached cable ties on complete electrical wiring harness (1).  
If necessary,
- ↓
- Strap down extended length of electrical wiring harness (1) at a suitable point.

- 22 Install contact plate (38).  
**i**  
To do so, connect plug (9) and screw in screws.

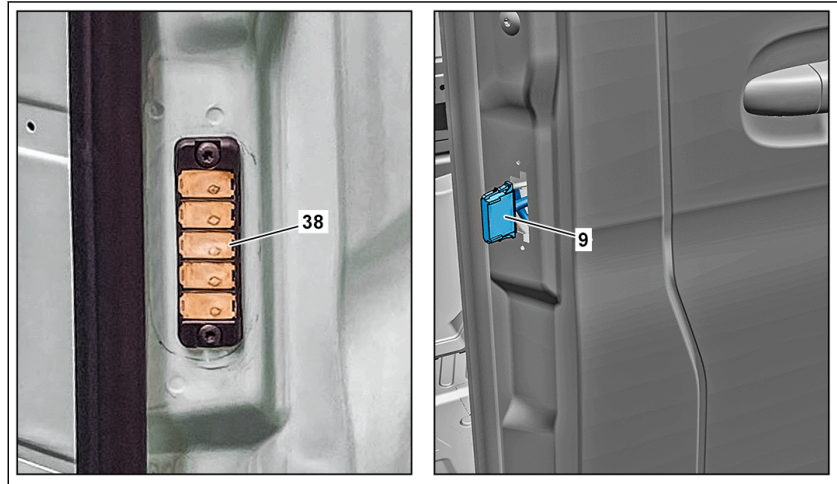

D72.16-A059-75

SM72.16-D-0008-03SG	Fabricate wiring harness for sliding door (code: VS3SCHIEBT, acc. no.: 72 951 62)		
Notice	Information on preventing damage to electronic components due to electrostatic discharge		AH54.00-P-0001-01A
Notice	Notes on carrying out repair work in the vehicle interior		AH68.00-D-0001-01KOS
Notice	Notes on retrofitting electrical/optical lines		AH82.00-P-0000-01A
PE	Wiring diagram for sliding door		PE72.16-D-2001LAA

**Model 907.6/7**  
**with code ZU8 (National version for USA)**

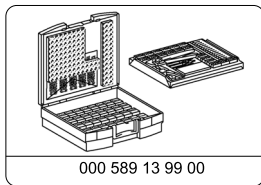

Wiring harness repair  
kit, basic



The following specified line colors for the electric lines correspond to the series production configuration and they can be replaced, if necessary, with similar line colors. Please ensure that electrical lines can be correctly assigned in accordance with slot assignment.

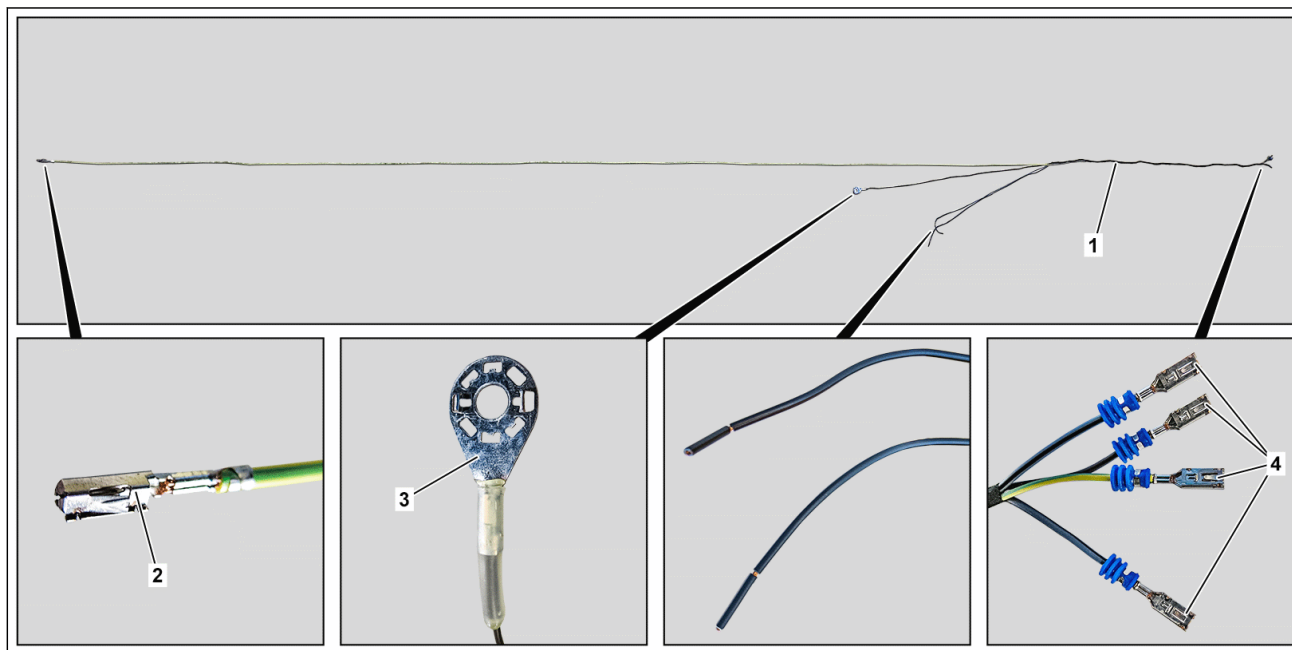

D72.16-A036-79

- |   |  |  |
|---|--|--|
| 1 | <p>Prepare electric line "YE/GN".</p> <p><b>i</b></p> <p>X100/1 to RBA1<br/>Line color "YE/GN"<br/>Length approx. 410 cm<br/>Cross section 0.5 mm<sup>2</sup></p>    | <p><b>i</b></p> <p>X100/1 to Z21/17<br/>Line color "BU/BN"<br/>Length approx. 232 cm<br/>Cross section 0.75 mm<sup>2</sup></p>   |
| 2 | <p>Prepare electric line "BN".</p> <p><b>i</b></p> <p>X100/1 to W105/1<br/>Line color "BN"<br/>Length approx. 255 cm<br/>Cross section 0.5 mm<sup>2</sup></p>        | 5  |
| 3 | <p>Prepare electric line "BU/BK".</p> <p><b>i</b></p> <p>X100/1 to Z21/16<br/>Line color "BU/BK"<br/>Length approx. 232 cm<br/>Cross section 0.75 mm<sup>2</sup></p> | <p>Crimp contact socket (2) onto electric line "YE/GN".</p> <p><b>i</b></p> <p> Use basic wiring harness repair kit.</p> <p><b>i</b></p> <p>A 013 545 76 26 Contact socket</p> |
| 4 | <p>Prepare electric line "BU/BN".</p>  | 6  |
| 7 | <p>Crimp contact sockets (4) on one side onto electric lines "YE/GN", "BN", "BU/BK", "BN/BN".</p> <p><b>i</b></p> <p> Use basic wiring harness repair kit.</p>       | <p>Crimp cable lug (3) onto electric line "BN".</p> <p><b>i</b></p> <p> Use basic wiring harness repair kit.</p> <p><b>i</b></p> <p>A 001 982 57 02 Cable lug</p>              |



A 009 545 81 26 Contact socket

A 001 545 78 80 Seal

- 8 Attach note in online vehicle data card under field organization texts to KG72. If line colors of prepared wiring harness (1) deviate from series production configuration.



**Note:**

Line colors of retrofitted wiring harness for sliding door deviate from series production configuration.

SM72.16-D-0008-04SG	Retrofit reinforcement for lock striker in C-pillar (code: VS3SCHIEBT, acc. no.: 72 951 62)		
---------------------	---	--	--

**Model 907.6/7**  
**with code ZU8 (National version for USA)**

- 1 Remove reinforcement (38) from C-pillar new part.



To do so, bend reinforcement (38) slightly in upper area (arrow). This makes removal easier.



The new C-pillar part is not required and should be disposed of properly.

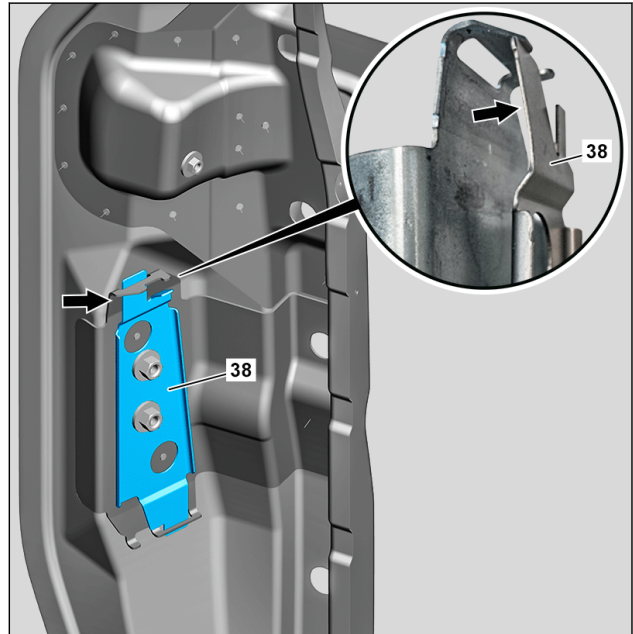

D72.16-A078-82

- 2 Install reinforcement (38) on C-pillar (40).

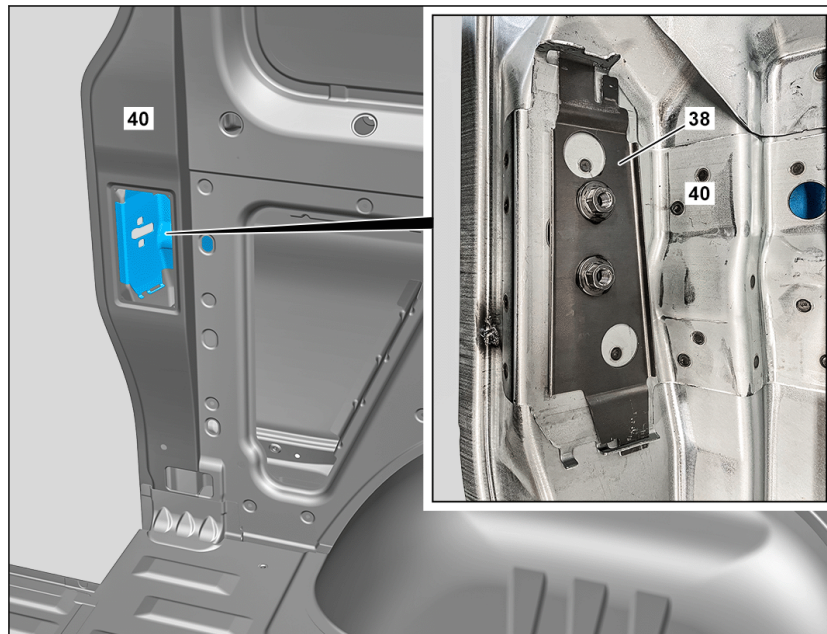

D72.16-A071-76

- 3 Install lock striker (41).



Tighten screws slightly by hand. Screws are tightened when adjusting sliding door.

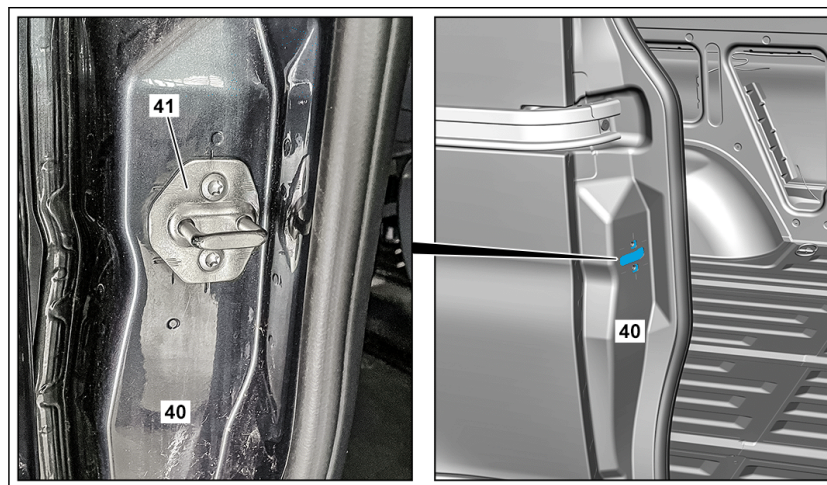

D72.16-A080-75

SM72.16-D-0009SG	Prepare vehicle interior at front for sliding door conversion (code: VS3SCHIEBT, acc. no.: 72 951 62)	18.07.2022
------------------	---	------------

**Model** 907  
with code ZU8 (National version for USA)

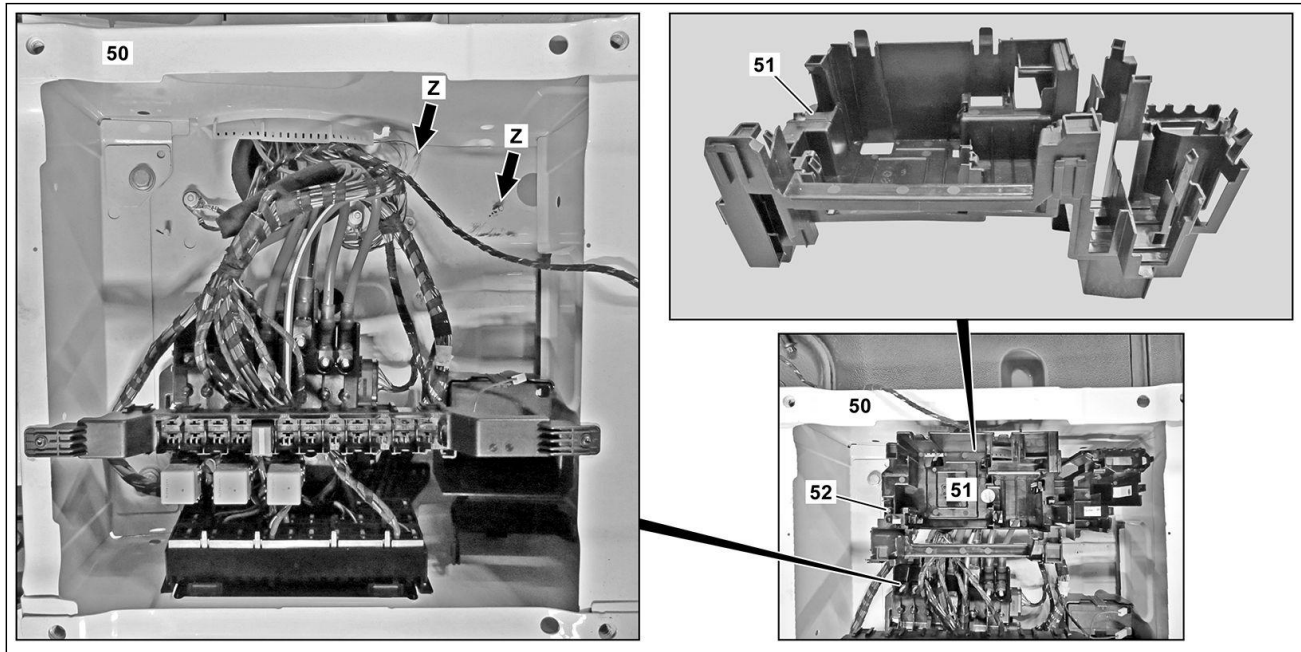

51 Control unit bracket

52 Nut

D54.21-A026-09



**Shown on model 907.7 without S23 (Front passenger bench seat)**

- 10 Cover
- 11 Nuts
- 12 Air duct







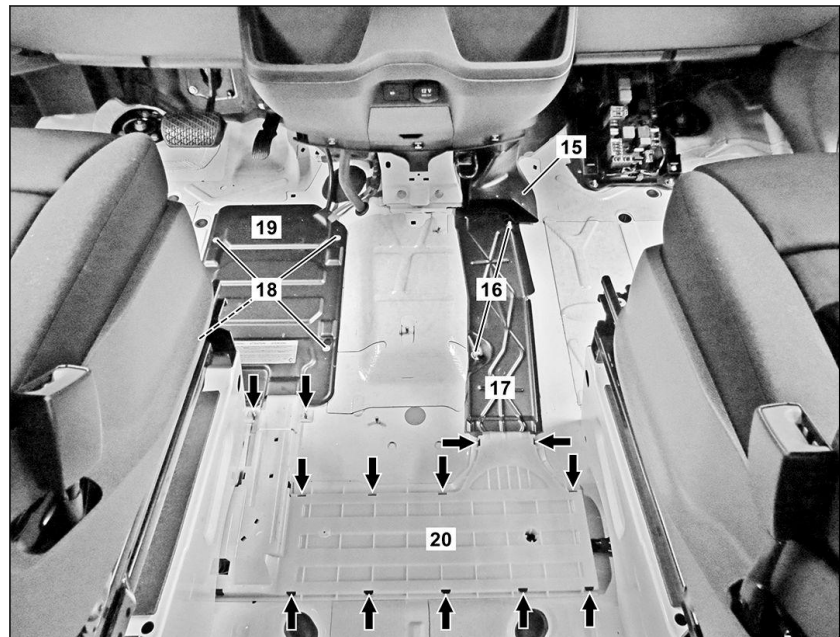

D31.19-1216-12









**Shown on model 907.7 without S23 (Front passenger bench seat)**















- 15 Air duct
- 16 Nuts
- 17 Cable duct
- 18 Bolts
- 19 Battery cover
- 20 Cover



D31.19-1217-06

 <b>Warning</b>	<b>Risk of injury</b> caused by fingers being jammed or pinched when removing, installing or aligning hoods, doors, trunk lid/rear-end door or sliding roof.	No parts of the body or limbs should be within the operating area when the components are moving.	AS00.00-Z-0011-01A
 <b>Caution</b>	<b>Risk of injury</b> caused by scraping or cutting body parts on sharp vehicle parts	Always wear protective gloves when working on or near sharp and non-deburred vehicle parts. Deburr repair panels.	AS00.00-Z-0017-01A
<b>Notice</b>	Information on preventing damage to electronic components due to electrostatic discharge		AH54.00-P-0001-01A
<b>Notice</b>	Notes on carrying out repair work in the vehicle interior		AH68.00-D-0001-01KOS
<b>Notice</b>	Notes on retrofitting electrical/optical lines		AH82.00-P-0000-01A
	<b>Remove</b>		
1.1	Remove driver seat.	Model 907  with code ZU8 (National version for USA)  except code SR8 (Swivel base for driver' seat)	AR91.10-D-1000TS
 <b>AR</b>			
1.2	Remove turn plate with mounted driver's seat.	Model 907  with code SR8 (Swivel base for driver' seat)  with code ZU8 (National version for USA)   Do not separate driver's seat from turn plate.	AR91.10-D-1456TS
 <b>AR</b>			
2	Remove seat base cover from driver's seat.		

3	Remove control unit holder (51).	<p>If control unit holder (51) is installed.</p> <p> To do so, remove nut (52). Position control unit holder (51) so that ground points are accessible. The number of control units varies depending on the vehicle equipment.</p> <p>If control units are installed in control unit holder (51),</p> <p style="text-align: center;">↓</p> <p>unclip control units.</p> <p> Do not disconnect plugs of control units.</p>	
4.1	Remove front passenger seat.	<p>Model 907</p> <p>with code ZU8 (National version for USA)</p> <p>except code SR9 (Swivel base for co-driver' seat)</p>	AR91.10-D-1000TS
 4.2	Remove turn plate with installed front passenger seat.	<p>Model 907</p> <p>with code SR9 (Swivel base for co-driver' seat)</p> <p>with code ZU8 (National version for USA)</p> <p> Do not disconnect front passenger seat from turn plate.</p>	AR91.10-D-1456TS
5	Remove seat base cover of front passenger seat.		
 6	Remove front floor coverings.		AR68.80-D-0006TSR
 7	Remove vehicle tool kit carrier plate.		AR68.30-D-5021TS
 8	Remove lower A-pillar trim on front passenger side.		AR68.30-D-0012TSR
9	Remove cover (10).		
10	Remove air duct (12).	 For this purpose, remove nuts (11).	
11	Remove air duct (15).		

12	Remove cable duct (17).	 To do so, remove nuts (16).	
13	Remove battery cover (19).	 To do so, remove screws (18).	
14	Release cover (20).	 Release cover (20) using a suitable screwdriver (arrows). Release cover (20) until wiring harness can be routed.	
	<b>Install</b>		
15	Install cover (20).		
16	Install battery cover (19).	 To do so, tighten the screws (18).	
17	Install cable duct (17).	 To do so, attach nuts (16).  M6	<a href="#">BA00.10-Z-1002-01KOA</a>
18	Install air duct (15).		
19	Install air duct (12).	 To do this, attach nuts (11).  M6	<a href="#">BA00.10-Z-1002-01KOA</a>
20	Install cover (10).		
21	Install vehicle tool kit carrier plate.		AR68.30-D-5021TS
			
22	Install front floor coverings.		AR68.80-D-0006TSR
			
23	Install lower A-pillar trim on front passenger side.		AR68.30-D-0012TSR
			
24	Attach control unit holder (51).	If control unit holder (51) is installed.  Do not kink subharness during installation of control unit holder (51) and ensure that it is routed free of chafing. This prevents any damage.  To do so, attach nut (52). The number of control units varies depending on the vehicle equipment.  M6 If control units are installed in control unit holder (51), ↓ clip in control units.	<a href="#">BA00.10-Z-1002-01KOA</a>
25	Install seat base cover of driver's seat.		

26.1	Install driver seat.	Model 907  with code ZU8 (National version for USA)  except code SR8 (Swivel base for driver' seat)	AR91.10-D-1000TS
			
26.2	Install turn plate with driver's seat attached.	Model 907  with code SR8 (Swivel base for driver' seat)  with code ZU8 (National version for USA)	AR91.10-D-1456TS
			
27	Install seat base cover of front passenger seat.		
28.1	Install front passenger seat.	Model 907  with code ZU8 (National version for USA)  except code SR9 (Swivel base for co-driver' seat)	AR91.10-D-1000TS
			
28.2	Install turn plate with front passenger seat attached.	Model 907  with code SR9 (Swivel base for co-driver' seat)  with code ZU8 (National version for USA)	AR91.10-D-1456TS
			

 **Headless screws/bolts: screws/bolts and nuts, coarse-pitch thread**

Number	Designation		8.8	10.9
BA00.10-Z-1002-01KOA	M6	Galvanized	Nm 9	13
		Phosphated	Nm 9	12

 **Headless screws/bolts: screws/bolts and nuts, coarse-pitch thread**

Number	Designation		12.9
BA00.10-Z-1002-01KOA	M6	Galvanized	Nm 16
		Phosphated	Nm 14



Mercedes-Benz

Work instructions

---

**Van**

**Group 72**  
**CODE: VS3SCHIEBT**

**SM72.16-D-0008C**  
**17.11.2022**

**Sliding door conversion (code: VS3SCHIEBT, acc. no.: 72 951 62)**

**Model**      **907.6/7**

**with code EL9 (Two-way loudspeaker system in front and rear)**

**with code ZU8 (National version for USA)**

**with electric closing assist of right sliding door**



<b>SM72.16-D-0008C</b>	<b>Sliding door conversion (code: VS3SCHIEBT, acc. no.: 72 951 62)</b>	<b>09.11.2022</b>
------------------------	--	-------------------

**Model 907.6/7**  
**with code EL9 (Two-way loudspeaker system in front and rear)**  
**with code ZU8 (National version for USA)**  
**with electric closing assist of right sliding door**

**Operation no. of the operation texts or standard texts and flat rates**

Category	Op. no.	Operation text	Time	Damage Code	Code
L	02 0982	Operations: Modify sliding door on vehicle with code T50/EL9/V40	4.1 hrs	72 951 62	VS3SCHIEBT

**Important!**

On affected vehicles, the sliding door closing assist is removed.

**Replacement parts ordering:**

Before ordering the required replacement parts, the special equipment code T50 (Electrical closing assist for right sliding door) must be removed from the Vehicle Documentation (VeDoc). Only then can the correct replacement parts can be determined using XENTRY Parts Information.

**Vehicle documentation (VeDoc):**

Changes in VeDoc can only be made by users with write permission.

If no-one with change authorization is available, a ticket must be created in the "XENTRY Support and Feedback (XSF)" system for "Vehicle data/VeDoc".

Please note that the XSF ticket has to be approved by the national organization, something which involves additional processing time.

It may take a few days for the entry to be visible in VeDoc.

**In the event of problems:**

If problems arise while carrying out the service measure, please create a PTSS case.

To do this, use the "DTS pre-case checklist".

The most recent version is always available via the XENTRY Portal.



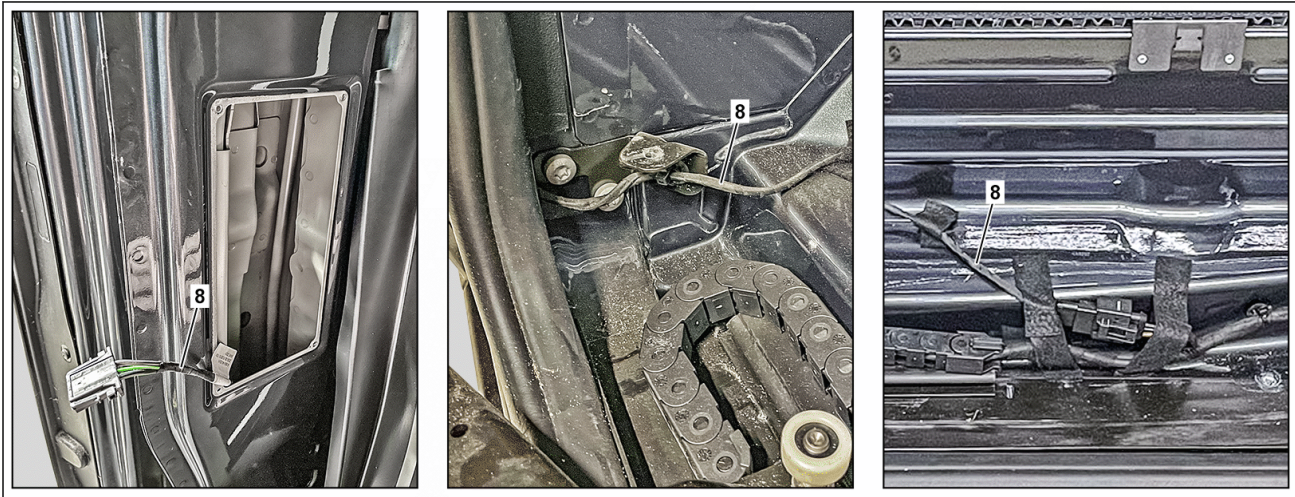























D72.16-A051-78

8 Closing assist motor electrical wiring harness

<b>Warning</b>	<b>Risk of injury</b> caused by fingers being jammed or pinched when removing, installing or aligning hoods, doors, trunk lid/rear-end door or sliding roof.	No parts of the body or limbs should be within the operating area when the components are moving.	AS00.00-Z-0011-01A
<b>Caution</b>	<b>Risk of injury</b> caused by scraping or cutting body parts on sharp vehicle parts	Always wear protective gloves when working on or near sharp and non-deburred vehicle parts. Deburr repair panels.	AS00.00-Z-0017-01A
<b>Notice</b>	Information on preventing damage to electronic components due to electrostatic discharge		AH54.00-P-0001-01A
<b>Notice</b>	Notes on carrying out repair work in the vehicle interior		AH68.00-D-0001-01KOS
<b>Notice</b>	Notes on retrofitting electrical/optical lines		AH82.00-P-0000-01A
	<b>Check</b>		
1	Check if vehicle is affected by measure.		
	<b>Update Vehicle Documentation (VeDoc)</b>		
2	Remove special equipment from online vehicle data card.	Remove existing code T50 (Electric closing assist for right sliding door).	

3	Attach "Sliding door converted as per SM72.16-D-0008C note" under field organization texts to KG72.		
	<b>Remove</b>		
4	Detach ground line of on-board electrical system battery.		AR54.10-D-0029TS
			
5	Remove component parts in vehicle interior for sliding door conversion.		<a href="#">Page 23</a>
6	Remove closing assist motor with lock striker in C-pillar.		AR72.16-D-0002TSR
		 The closing assist motor is no longer required.	
7	Remove lower guide rail for sliding door.		
		Model 907.6/7	AR72.16-D-7816TS
8	Remove closing assist motor electrical subharness (8).		
		 To do so, unclip electrical subharness (8), guide it out of C-pillar then disconnect electrical connector.	
		 The electrical subharness (8) is no longer required.	
		 Clip remover	<a href="#">452 589 01 63 00</a>
	<b>Modify sliding door</b>		
9	Remove electric sliding door control unit.		
		 The control unit is no longer required.	AR72.29-D-5898TS
10	Modify electrical wiring harness in sliding door.		<a href="#">Page 6</a>
	<b>Retrofit wiring harness in vehicle interior</b>		
11	Fabricate wiring harness for sliding door. Wiring diagram for sliding door		
		 Wiring harness repair kit, basic	PE72.16-D-2001LAA <a href="#">Page 18</a> <a href="#">000 589 13 99 00</a>

12	Retrofit wiring harness for sliding door. 000 588 00 84 00 Heat gun Repairing wiring harness using solder connectors Wiring diagram for sliding door Wiring diagram for loudspeakers		WS54.00-P-0049B AR00.19-P-0100-09A PE72.16-D-2001LAA PE82.62-D-2102LAA <b>Page 10</b> 220 589 01 99 41 220 589 01 99 42 000 589 13 99 00
	<b>Install</b>		
13	Retrofit reinforcement for lock striker in C-pillar.		<b>Page 21</b>
14	Install lower guide rail for sliding door.	Model 907.6/7	AR72.16-D-7816TS
15	Install removed component parts in vehicle interior for sliding door conversion.		<b>Page 23</b>
16	Connect ground line of on-board electrical system battery.		AR54.10-D-0029TS
	<b>SCN coding</b>		
17	Connect diagnostic system.	 It is absolutely essential to precisely follow the operation steps as described in the vehicle diagnosis system.	AD00.00-D-2000-06TS
18	Connect charging equipment.	 During the entire work procedure a sufficiently large voltage supply must be provided for the vehicle's on-board electrical system. Otherwise any undervoltage that occurs may damage the control units.  Follow the operating instructions for the charger.  Use the charger to ensure that an adequate power supply (min. 12.5 V) is provided for the on-board electrical system battery.	AR54.10-D-1127TS

19	Perform SCN coding on signal acquisition and actuation module (SAM) control unit.		AR54.21-D-0015TS
 AR		 Under the "Control unit adaptations" menu item, follow the instructions for "SCN coding".	
20	Remove charger from vehicle.		AR54.10-D-1127TS
 AR			
	<b>Check</b>		
21	Check sliding door for correct opening and closing.	 See Operator's Manual.	

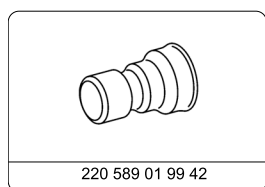

Adapter

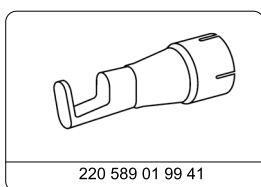

Reflector

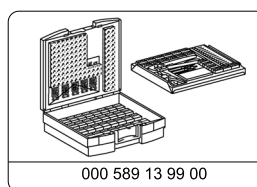

Wiring harness repair kit, basic

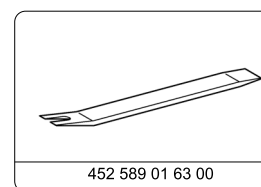

Clip remover

**Parts ordering note**

Part no.	Designation	Quantity
A 906 630 33 00	C-pillar	1
A 906 720 02 04	Lock striker	1
A 000 984 31 29	Screw	2
A 000 995 51 14	Line fastener	5
N 000000 000455	Screw	2
A 906 692 12 22	Cover (on vehicle with code V36 Roof lining)	2
A 906 692 07 22 9051	Cover	1
A 910 998 02 50 9051	Cover plug	n. B.
A 910 998 00 50 9051	Cover plug	n. B.
A 110 987 05 44	Cover plug	1
	Parts for electrical wiring harness:	
	Electric lines (available on free market, observe specifications)	4
A 013 545 76 26	Female contact	1
A 001 982 57 02	Cable lug (ground connection)	1
A 001 545 59 80	Seal	4
A 009 545 81 26	Female contact	4
A 000 545 78 80	Plug	4
A 000 995 25 94	Cable tie	n. B.

SM72.16-D-0008-01SGB	Convert sliding door (code: VS3SCHIEBT, acc. no.: 72 951 62)		
----------------------	--	--	--

**Model 907.6/7**  
**with code ZU8 (National version for USA)**  
**with electric closing assist of right sliding door**

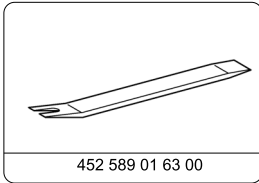

Clip remover

#### Refit electrical wiring harness

Shown on model 907.7 with code EL9 (2-way speaker system, front and rear)

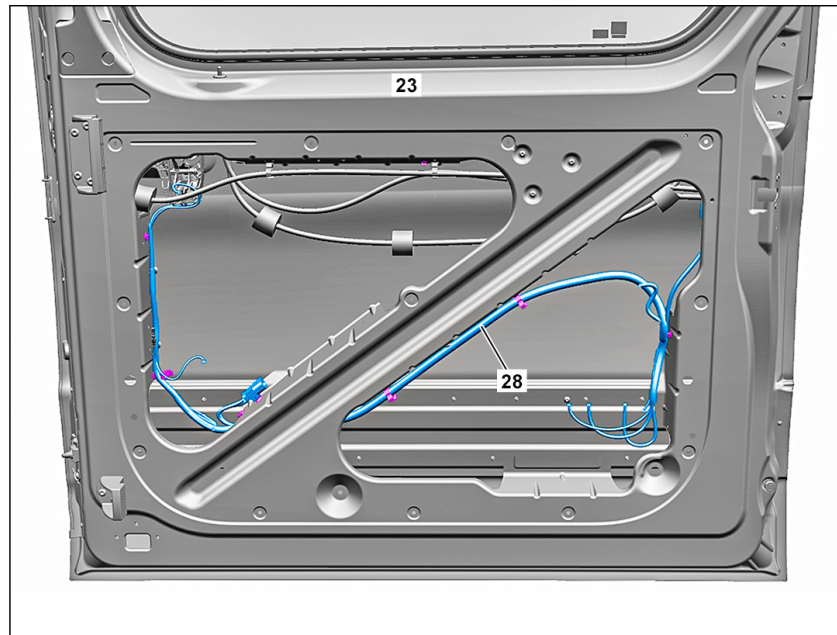

D72.16-A049-76

- 1 Remove electrical wiring harness (28).



To do so, unclip electrical wiring harness (28) from sliding door (23).

The number of fastenings can vary here, depending on the equipment installed.



The electrical wiring harness (28) is no longer required.

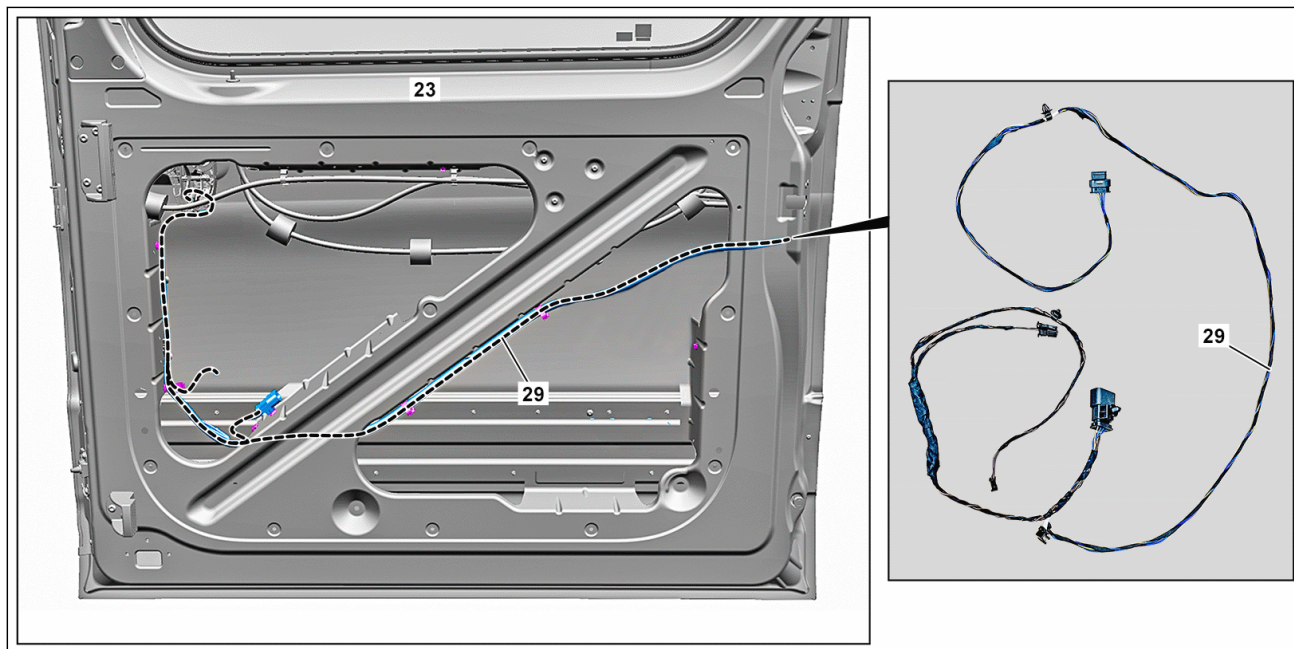

D72.16-A050-79

**Shown on model 907.7 with code EL9 (2-way speaker system, front and rear)**

- 2 Install new electrical wiring harness (29) as shown.



Order part number for electrical wiring harness (29) according to list below.



Continue in the higher-level service document.

-----  
**Modify sliding door detachable parts**

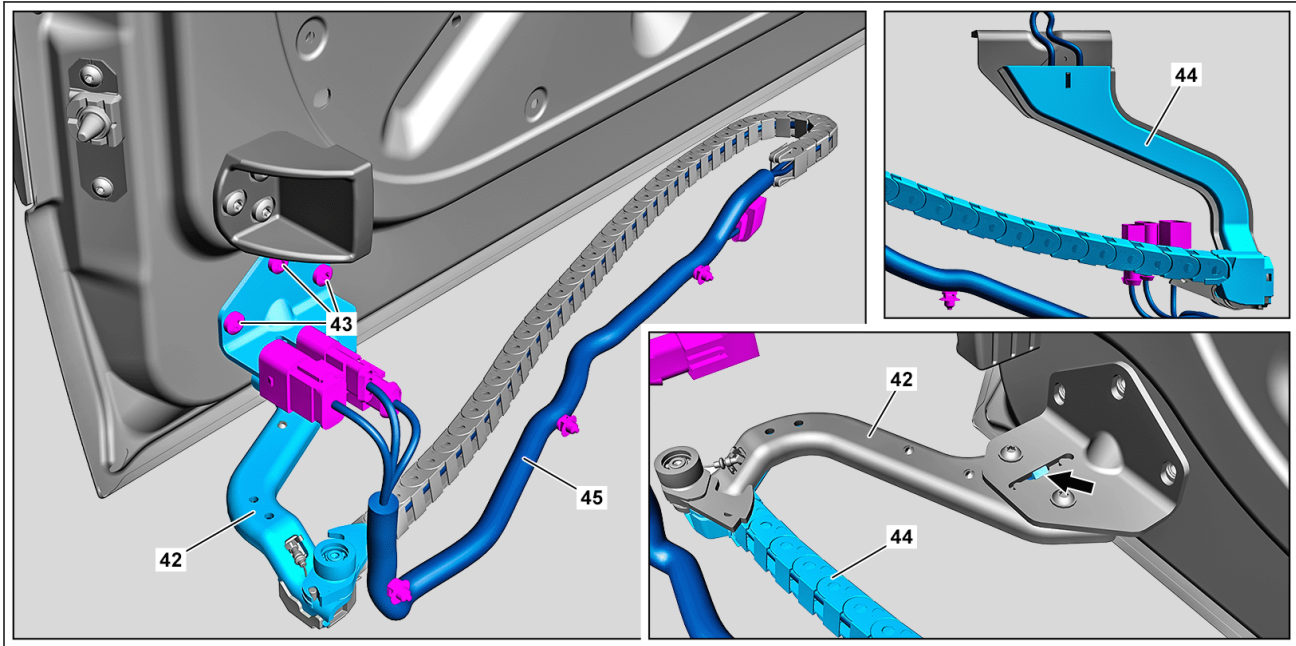

D72.16-A079-79

- 3 Remove lower carriage (42) from sliding door.



For this purpose, remove screws (43).



The removed lower carriage (42) is no longer required.

- 4 Release cable duct (44) (arrow) and remove from lower sliding carriage (42).

- 5 Remove cable duct (44) with electrical wiring harness (45).

- 6 Remove cover (46).



To do this, remove screws (47).



D72.16-A081-81

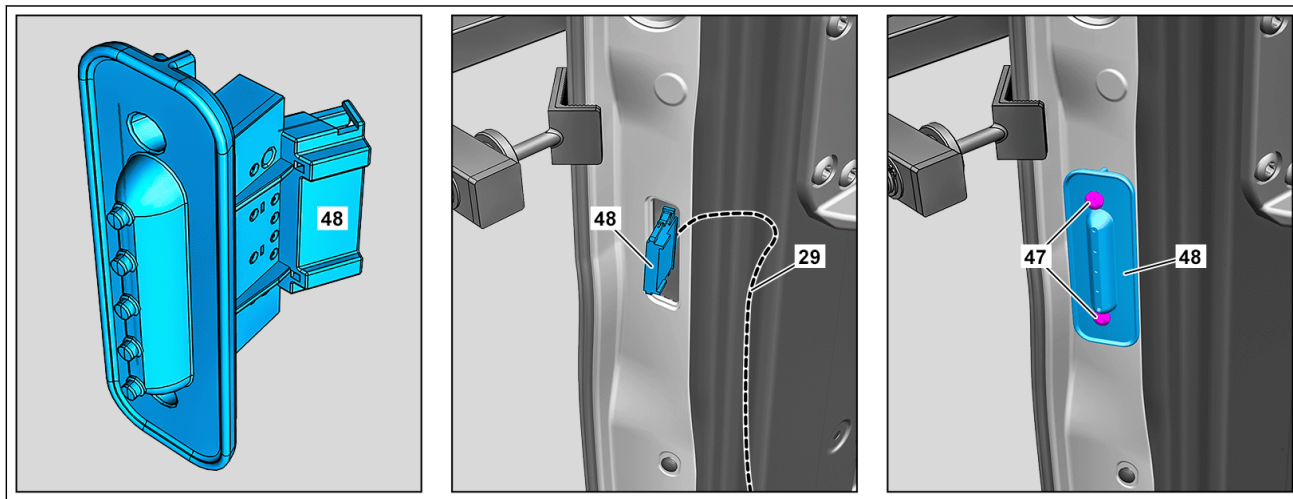

D72.16-A077-78

- 7 Connect contact switch (48) to plug connector (49) of new electrical wiring harness (29).
- 8 Install contact switch (48).



To do so, turn in screws (47).



SM72.16-D-0008-02SGB	Retrofit wiring harness for sliding door (code: VS3SCHIEBT, acc. no.: 72 951 62)		
<b>Notice</b>	Information on preventing damage to electronic components due to electrostatic discharge		AH54.00-P-0001-01A
<b>Notice</b>	Notes on carrying out repair work in the vehicle interior		AH68.00-D-0001-01KOS
<b>WS</b>	000 588 00 84 00 Heat gun		WS54.00-P-0049B
<b>AR</b>	Repairing wiring harness using solder connectors		AR00.19-P-0100-09A
<b>PE</b>	Wiring diagram for sliding door		PE72.16-D-2001LAA

**Model 907.6/7****with code EL9 (Two-way loudspeaker system in front and rear)****with code ZU8 (National version for USA)****Nm** Headless screws/bolts: screws/bolts and nuts, coarse-pitch thread

Number	Designation		8.8	10.9
BA00.10-Z-1002-01KOA	M6	Galvanized	Nm 9	13
		Phosphated	Nm 9	12

**Nm** Headless screws/bolts: screws/bolts and nuts, coarse-pitch thread

Number	Designation		12.9
BA00.10-Z-1002-01KOA	M6	Galvanized	Nm 16
		Phosphated	Nm 14

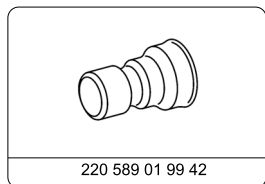

Adapter

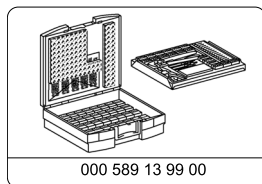

Wiring harness repair kit, basic

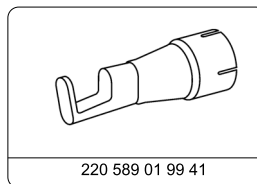

Reflector



Do not kink any electric lines and ensure that they are routed without any chafing.

This prevents any damage.

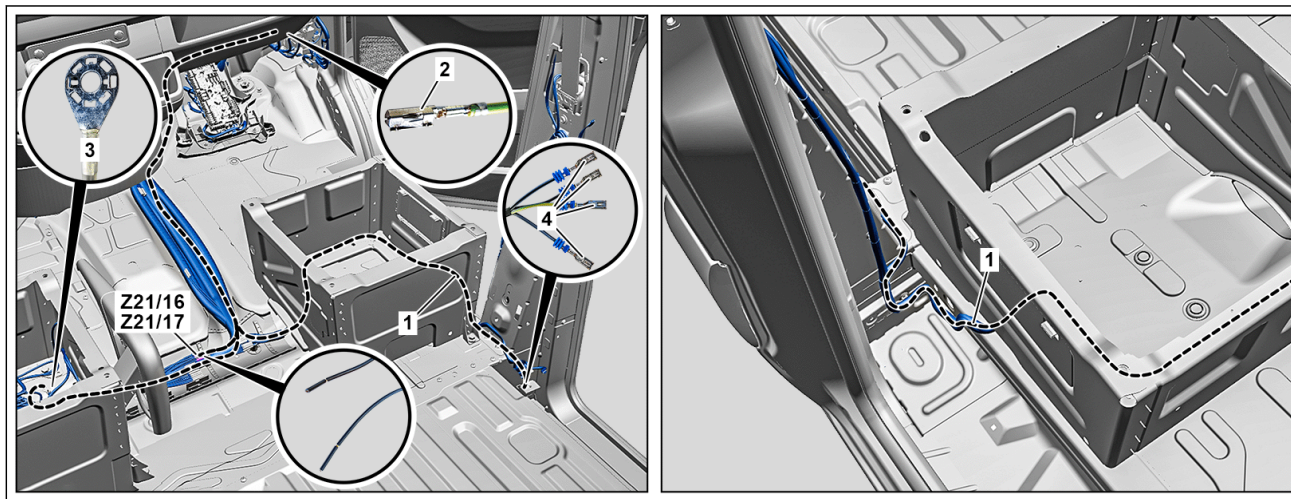

D72.16-A060-78

### Route electrical wiring harness (1)



The following specified line colors for the electric lines correspond to the series production configuration.

- 1 Route electric lines "YE/GN", "BN", "BU/BK", as shown.
- 2 Join electric lines "YE/GN", "BN", "BU/BK", "BU/BN" and wrap, section-by-section, with suitable insulation tape.



The electrical wiring harness (1) is made up of the electric lines "YE/GN", "BN", "BU/BK", "BU/BN".

Make sure that the junctions of the electric lines "YE/GN", "BN", "BU/BK", "BU/BN" remain free at the connection end.

- 3 Loosely fasten electrical wiring harness (1) in sections at factory-installed electrical wiring harness or at a suitable position using cable ties.

### Electrical wiring harness (1) to end sleeves

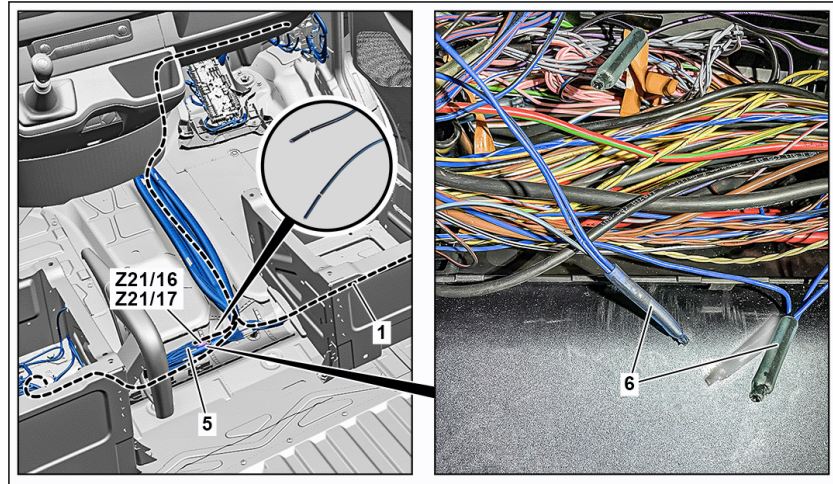

D72.16-A038-75

- |  |  |
|--|--|
| <p>4</p> <p>Disconnect control circuit 1 central locking end sleeve (Z21/16) from electrical wiring harness (5).</p> <p><b>i</b><br/>Electric line "BU/BK".</p>  | <p>6</p> <p>Disconnect control circuit 1 central locking end sleeve (Z21/17) from electrical wiring harness (5).</p> <p><b>i</b><br/>Electric line "BU/BN".</p>  |
| <p>5</p> <p>Connect electric line "BU/BK" of electrical wiring harness (5) and electric line "BU/BK" of electrical wiring harness (1) to new end sleeve (6).</p> <p><b>i</b><br/>To do so, use heat gun with <b>3</b> reflector or <b>4</b> adapter.<br/><b>3</b> Use basic wiring harness repair kit.</p> | <p>7</p> <p>Connect electric line "BU/BN" of electrical wiring harness (5) and electric line "BU/BN" of electrical wiring harness (1) to new end sleeve (6).</p> <p><b>i</b><br/>To do so, use heat gun with <b>3</b> reflector or <b>4</b> adapter.<br/><b>3</b> Use basic wiring harness repair kit.</p> |

**Electrical wiring harness (1) to signal acquisition and actuation module (SAM) control unit**

- 8 Release and disconnect electrical connector (RBA1) from SAM (N10).



D72.16-A039-76

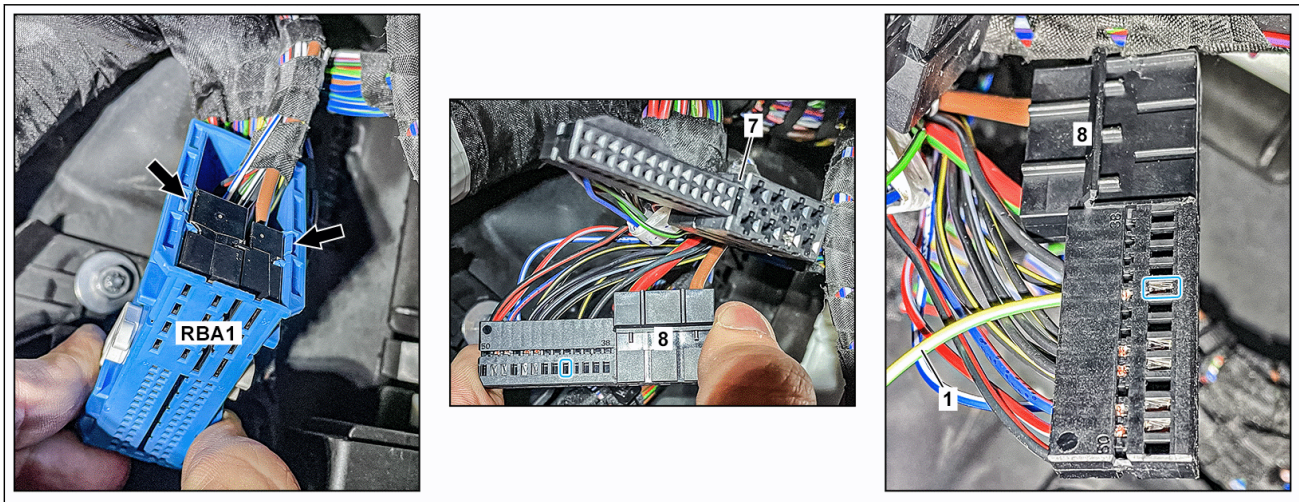

D72.16-A040-78

- 9 Disassemble electrical connector (RBA1).  
**i**  
 To do so, release plug housing (arrows A), guide out plugs (7, 8) and disconnect from each other.
- 10 Install electric line "YE/GN" of electrical wiring harness (1) into contact cavity 42 of plug (8).

- 11 Assemble electrical connector (RBA1).  
**i**  
 To do so, connect plugs (7, 8) and guide into plug housing, then lock.
- 12 Use cable ties to fasten electric line "YE/GN" directly behind plug housing of electrical connector (RBA1) to factory-installed electrical wiring harness.

13 Strap down extended length of electric line "YE/GN" at suitable point.

14 Connect electrical connector (RBA1) to SAM control unit (N10).

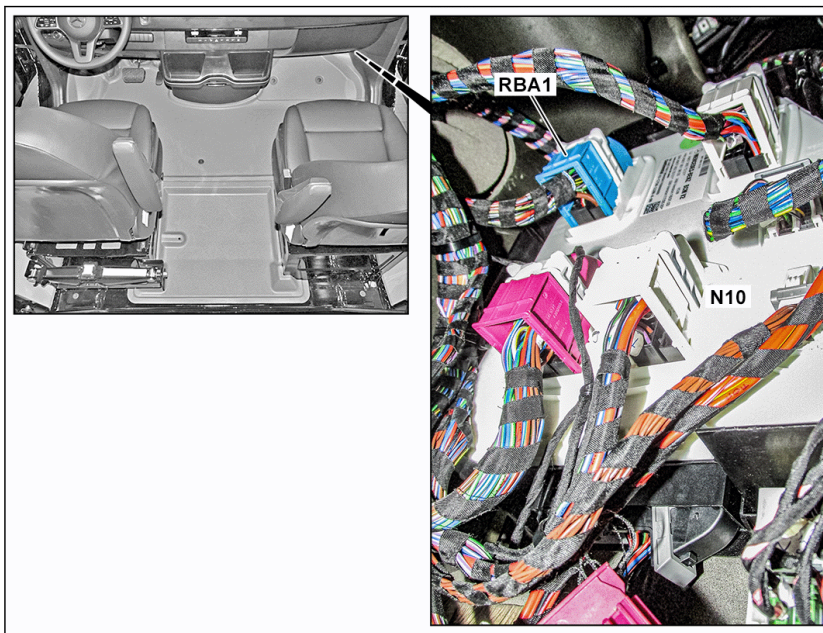

D72.16-A039-76

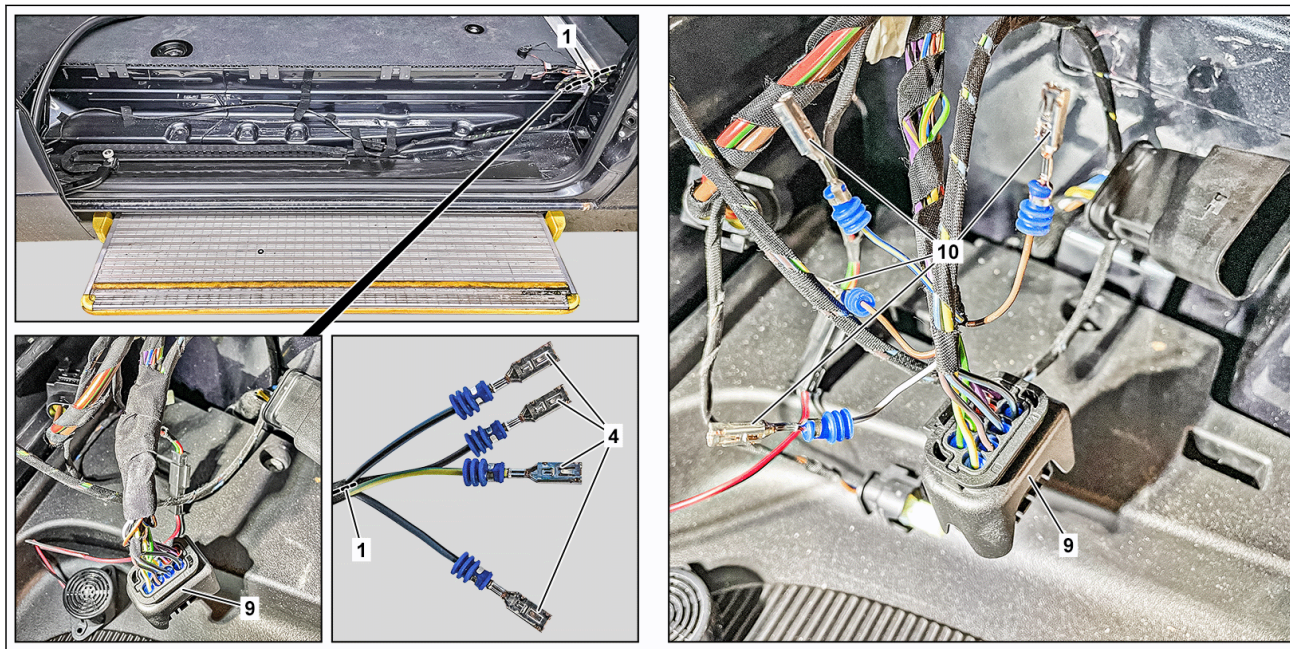

D72.16-A061-79

**Electrical wiring harness (1) to "Right sliding door electrical connector 1 (B-pillar) (X100/11x1)" or "Right**

**sliding door electrical connector 3 (B-pillar)  
(X100/11x3)" (plug (9))**

- 15 Remove contact sockets (10) from contact cavities 1, 2, 3, 4, 7, 8 of plug (9).  
**i**  
For this purpose, **🔧** use basic wiring harness repair kit.
- 16 Use fabric tape to individually insulate removed contact sockets (10).
- 17 Strap down removed contact sockets (10) at suitable point using cable tie.
- 19 Connect plug (9) to plug (11).

- 18 Install contact sockets (4) in plug (9).  
**i**  
Contact cavity 1: Electric line **"YE/GN"**  
Contact cavity 2: Electric line **"BN"**  
Contact cavity 3: Electric line **BU/BN**  
Contact cavity 4: Electric line **"BU/BK"**  
Contact cavity 5: Electric line **"VT/YE"**  
Contact cavity 6: Electric line **"VT/BK"**

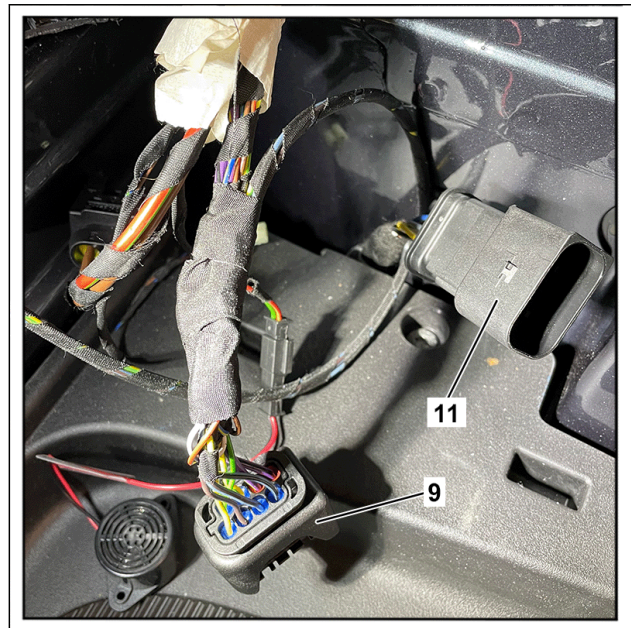

D72.16-A062-82

- 20 Remove plug connector (51) from closing assist motor electrical wiring harness (8).
- i**  
For this purpose, **S** use basic wiring harness repair kit.
- 21 Install blind plugs (9) into plug connector (51).
- 22 Reinstall plug connector (51) on factory-installed electrical wiring harness.

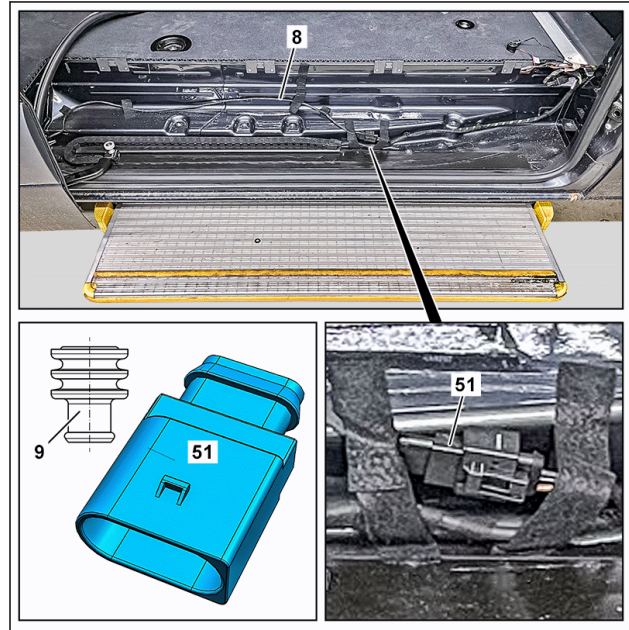

D72.16-A082-82

### Electrical wiring harness (1) to ground connection

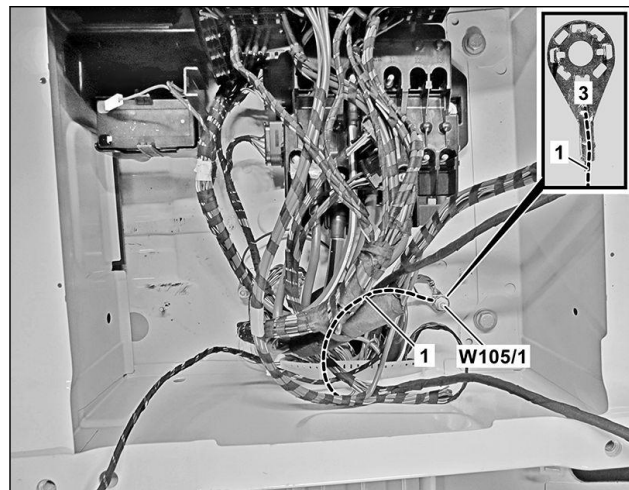

D72.16-A042-11

- 23 Remove nut of driver seat base ground point 1 (W105/1).
- 24 Connect cable lug (3) of electrical wiring harness (1) to driver seat base ground point 1 (W105/1).
- 25 Attach nut of driver seat base ground point 1 (W105/1) **Nm**.

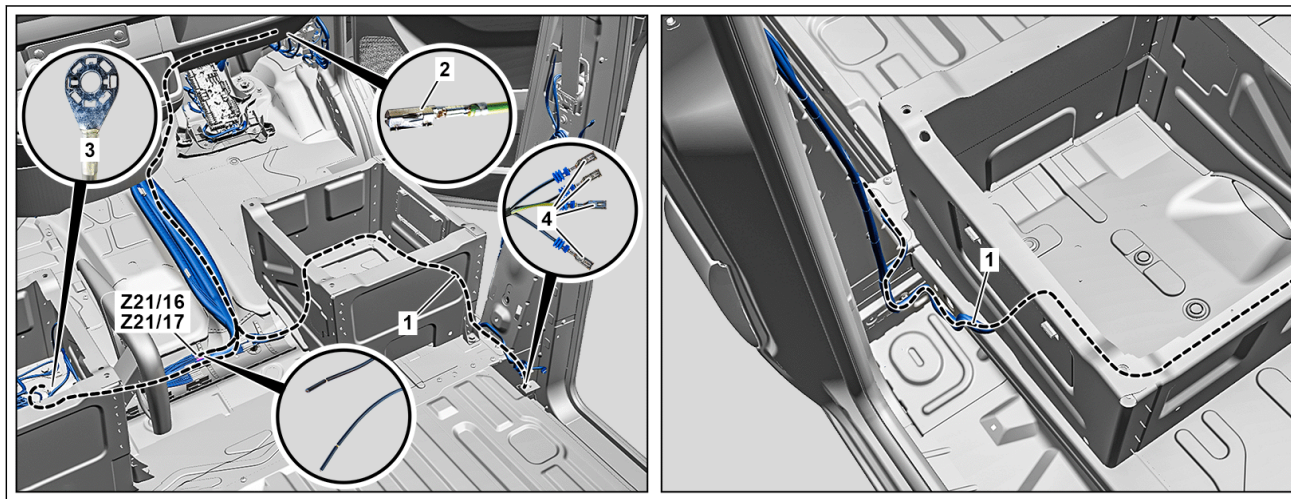

D72.16-A060-78

### Tighten electrical wiring harness (1)

- 26 Tighten loosely attached cable ties on complete electrical wiring harness (1).  
If necessary,

↓  
Strap down extended length of electrical wiring harness (1) at a suitable point.



SM72.16-D-0008-03SG	Fabricate wiring harness for sliding door (code: VS3SCHIEBT, acc. no.: 72 951 62)		
Notice	Information on preventing damage to electronic components due to electrostatic discharge		AH54.00-P-0001-01A
Notice	Notes on carrying out repair work in the vehicle interior		AH68.00-D-0001-01KOS
Notice	Notes on retrofitting electrical/optical lines		AH82.00-P-0000-01A
PE	Wiring diagram for sliding door		PE72.16-D-2001LAA

**Model 907.6/7**  
**with code ZU8 (National version for USA)**

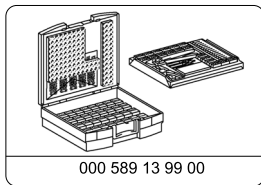

Wiring harness repair  
kit, basic



The following specified line colors for the electric lines correspond to the series production configuration and they can be replaced, if necessary, with similar line colors. Please ensure that electrical lines can be correctly assigned in accordance with slot assignment.

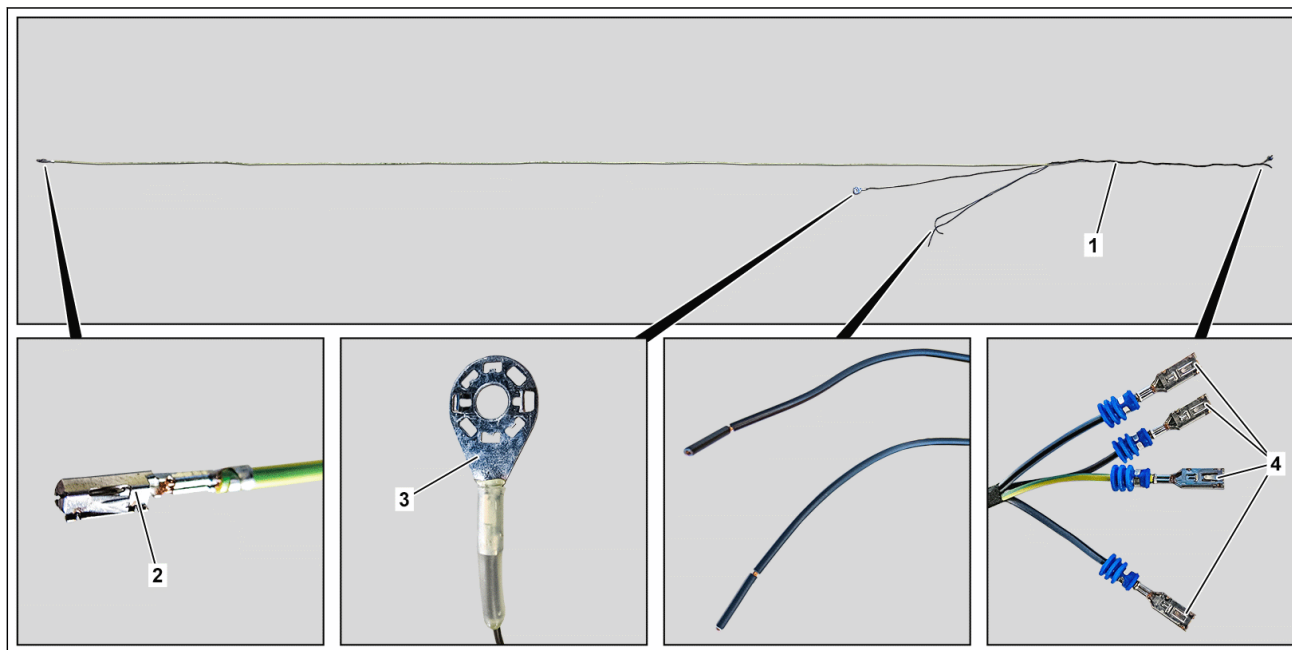

D72.16-A036-79

- 1 Prepare electric line "YE/GN".  
*i*  
 X100/1 to RBA1  
 Line color "YE/GN"  
 Length approx. 410 cm  
 Cross section 0.5 mm<sup>2</sup>
- 2 Prepare electric line "BN".  
*i*  
 X100/1 to W105/1  
 Line color "BN"  
 Length approx. 255 cm  
 Cross section 0.5 mm<sup>2</sup>
- 3 Prepare electric line "BU/BK".  
*i*  
 X100/1 to Z21/16  
 Line color "BU/BK"  
 Length approx. 232 cm  
 Cross section 0.75 mm<sup>2</sup>
- 4 Prepare electric line "BU/BN".
- 5 Crimp contact socket (2) onto electric line "YE/GN".  
*i*  
 X100/1 to Z21/17  
 Line color "BU/BN"  
 Length approx. 232 cm  
 Cross section 0.75 mm<sup>2</sup>
- 6 Crimp cable lug (3) onto electric line "BN".  
*i*  
 Use basic wiring harness repair kit.  
*i*  
 A 013 545 76 26 Contact socket
- 7 Crimp contact sockets (4) on one side onto electric lines "YE/GN", "BN", "BU/BK", "BN/BN".  
*i*  
 Use basic wiring harness repair kit.



A 009 545 81 26 Contact socket

A 001 545 78 80 Seal

- 8 Attach note in online vehicle data card under field organization texts to KG72. If line colors of prepared wiring harness (1) deviate from series production configuration.



**Note:**

Line colors of retrofitted wiring harness for sliding door deviate from series production configuration.

SM72.16-D-0008-04SG	Retrofit reinforcement for lock striker in C-pillar (code: VS3SCHIEBT, acc. no.: 72 951 62)		
---------------------	---	--	--

**Model 907.6/7**  
**with code ZU8 (National version for USA)**

- 1 Remove reinforcement (38) from C-pillar new part.



To do so, bend reinforcement (38) slightly in upper area (arrow). This makes removal easier.



The new C-pillar part is not required and should be disposed of properly.

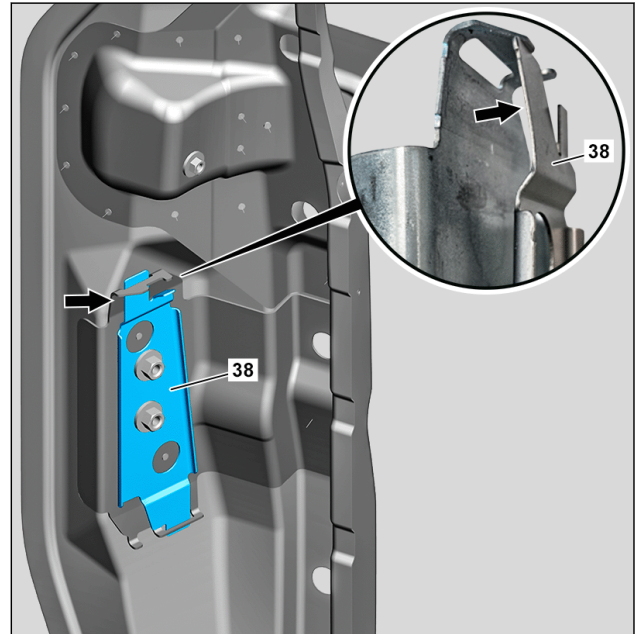

D72.16-A078-82

- 2 Install reinforcement (38) on C-pillar (40).

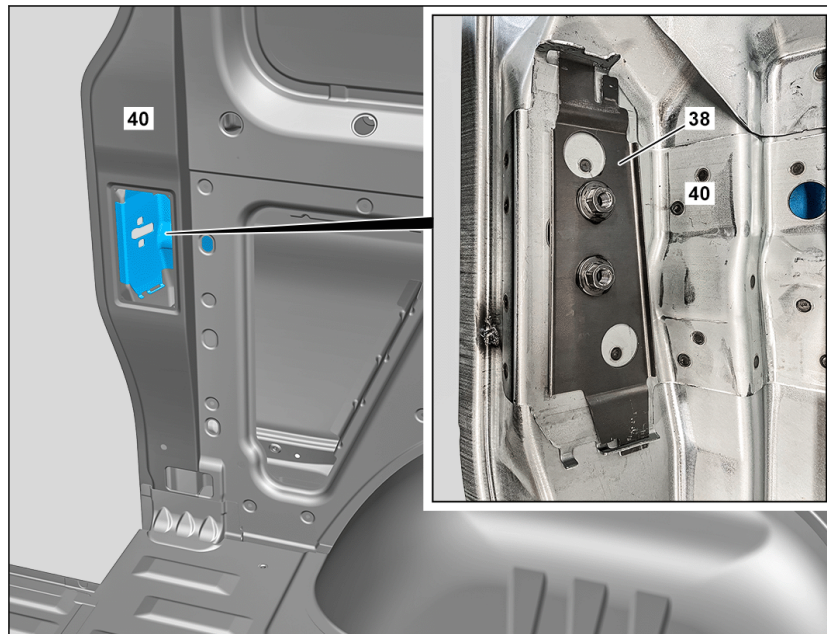

D72.16-A071-76

- 3 Install lock striker (41).



Tighten screws slightly by hand. Screws are tightened when adjusting sliding door.

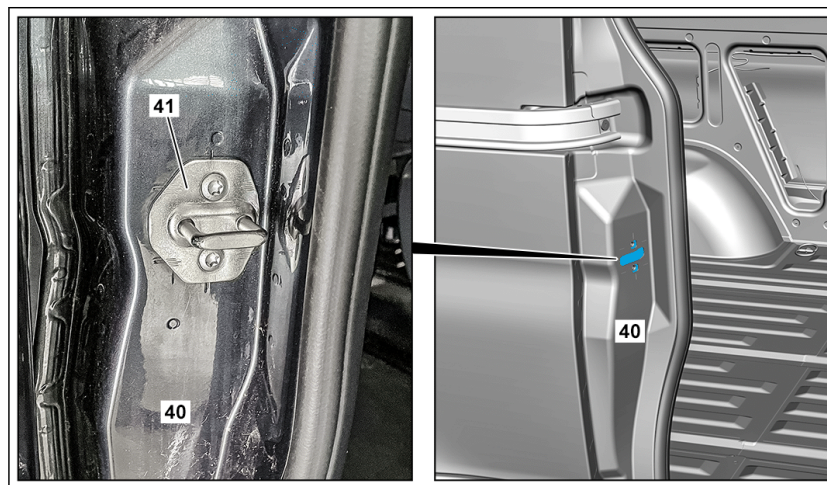

D72.16-A080-75

SM72.16-D-0009SG	Prepare vehicle interior at front for sliding door conversion (code: VS3SCHIEBT, acc. no.: 72 951 62)	18.07.2022
------------------	---	------------

**Model** 907  
with code ZU8 (National version for USA)

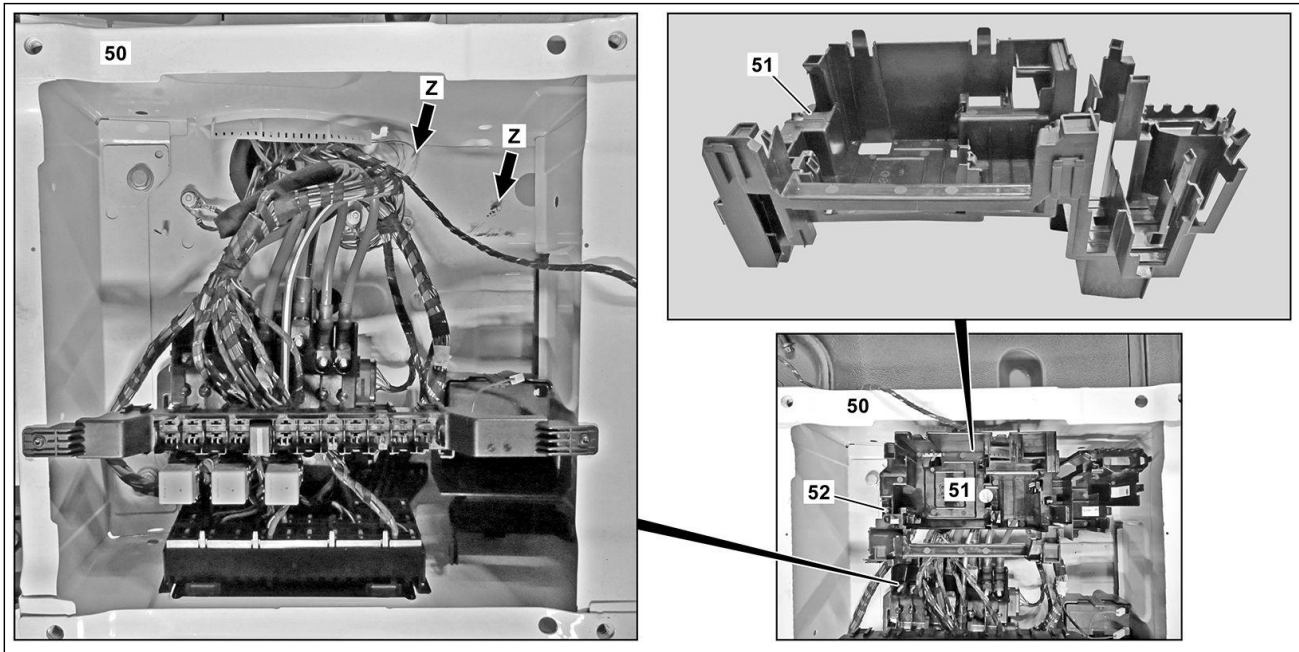

51 Control unit bracket

52 Nut

D54.21-A026-09

**Shown on model 907.7 without S23 (Front passenger bench seat)**

- 10 Cover
- 11 Nuts
- 12 Air duct







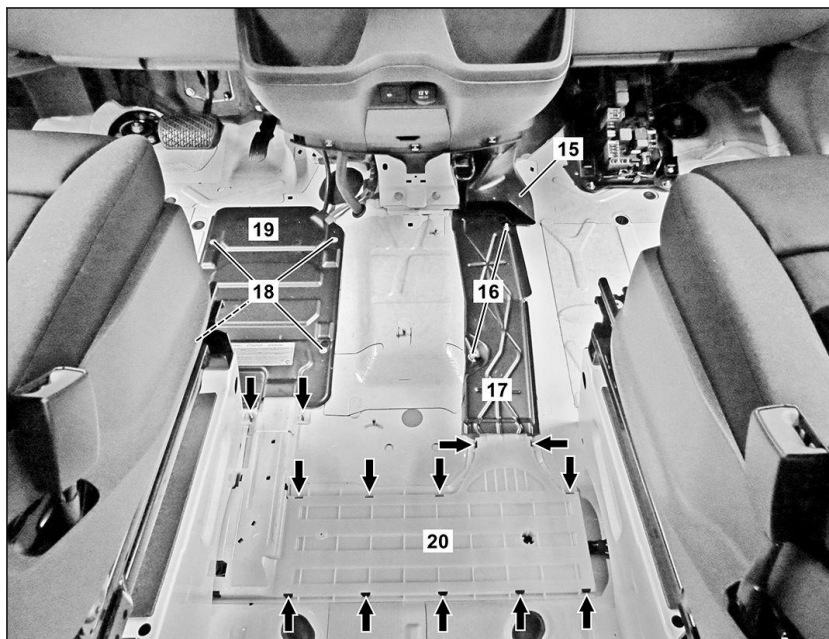

D31.19-1216-12

**Shown on model 907.7 without S23 (Front passenger bench seat)**









- 15 Air duct
- 16 Nuts
- 17 Cable duct
- 18 Bolts
- 19 Battery cover
- 20 Cover

















D31.19-1217-06

 <b>Warning</b>	<b>Risk of injury</b> caused by fingers being jammed or pinched when removing, installing or aligning hoods, doors, trunk lid/rear-end door or sliding roof.	No parts of the body or limbs should be within the operating area when the components are moving.	AS00.00-Z-0011-01A
 <b>Caution</b>	<b>Risk of injury</b> caused by scraping or cutting body parts on sharp vehicle parts	Always wear protective gloves when working on or near sharp and non-deburred vehicle parts. Deburr repair panels.	AS00.00-Z-0017-01A
<b>Notice</b>	Information on preventing damage to electronic components due to electrostatic discharge		AH54.00-P-0001-01A
<b>Notice</b>	Notes on carrying out repair work in the vehicle interior		AH68.00-D-0001-01KOS
<b>Notice</b>	Notes on retrofitting electrical/optical lines		AH82.00-P-0000-01A
	<b>Remove</b>		
1.1	Remove driver seat.	Model 907  with code ZU8 (National version for USA)  except code SR8 (Swivel base for driver' seat)	AR91.10-D-1000TS
 <b>AR</b>			
1.2	Remove turn plate with mounted driver's seat.	Model 907  with code SR8 (Swivel base for driver' seat)  with code ZU8 (National version for USA)   Do not separate driver's seat from turn plate.	AR91.10-D-1456TS
 <b>AR</b>			
2	Remove seat base cover from driver's seat.		



3	Remove control unit holder (51).	<p>If control unit holder (51) is installed.</p> <p> To do so, remove nut (52). Position control unit holder (51) so that ground points are accessible. The number of control units varies depending on the vehicle equipment.</p> <p>If control units are installed in control unit holder (51),</p> <p style="text-align: center;">↓</p> <p>unclip control units.</p> <p> Do not disconnect plugs of control units.</p>	
4.1	Remove front passenger seat.	<p>Model 907</p> <p>with code ZU8 (National version for USA)</p> <p>except code SR9 (Swivel base for co-driver' seat)</p>	AR91.10-D-1000TS
 4.2	Remove turn plate with installed front passenger seat.	<p>Model 907</p> <p>with code SR9 (Swivel base for co-driver' seat)</p> <p>with code ZU8 (National version for USA)</p> <p> Do not disconnect front passenger seat from turn plate.</p>	AR91.10-D-1456TS
5	Remove seat base cover of front passenger seat.		
 6	Remove front floor coverings.		AR68.80-D-0006TSR
 7	Remove vehicle tool kit carrier plate.		AR68.30-D-5021TS
 8	Remove lower A-pillar trim on front passenger side.		AR68.30-D-0012TSR
9	Remove cover (10).		
10	Remove air duct (12).	 For this purpose, remove nuts (11).	
11	Remove air duct (15).		

12	Remove cable duct (17).	 To do so, remove nuts (16).	
13	Remove battery cover (19).	 To do so, remove screws (18).	
14	Release cover (20).	 Release cover (20) using a suitable screwdriver (arrows). Release cover (20) until wiring harness can be routed.	
	<b>Install</b>		
15	Install cover (20).		
16	Install battery cover (19).	 To do so, tighten the screws (18).	
17	Install cable duct (17).	 To do so, attach nuts (16).  M6	<a href="#">BA00.10-Z-1002-01KOA</a>
18	Install air duct (15).		
19	Install air duct (12).	 To do this, attach nuts (11).  M6	<a href="#">BA00.10-Z-1002-01KOA</a>
20	Install cover (10).		
21	Install vehicle tool kit carrier plate.		AR68.30-D-5021TS
			
22	Install front floor coverings.		AR68.80-D-0006TSR
			
23	Install lower A-pillar trim on front passenger side.		AR68.30-D-0012TSR
			
24	Attach control unit holder (51).	If control unit holder (51) is installed.  Do not kink subharness during installation of control unit holder (51) and ensure that it is routed free of chafing. This prevents any damage.  To do so, attach nut (52). The number of control units varies depending on the vehicle equipment.  M6 If control units are installed in control unit holder (51), ↓ clip in control units.	<a href="#">BA00.10-Z-1002-01KOA</a>
25	Install seat base cover of driver's seat.		

26.1	Install driver seat.	Model 907  with code ZU8 (National version for USA)  except code SR8 (Swivel base for driver' seat)	AR91.10-D-1000TS
			
26.2	Install turn plate with driver's seat attached.	Model 907  with code SR8 (Swivel base for driver' seat)  with code ZU8 (National version for USA)	AR91.10-D-1456TS
			
27	Install seat base cover of front passenger seat.		
28.1	Install front passenger seat.	Model 907  with code ZU8 (National version for USA)  except code SR9 (Swivel base for co-driver' seat)	AR91.10-D-1000TS
			
28.2	Install turn plate with front passenger seat attached.	Model 907  with code SR9 (Swivel base for co-driver' seat)  with code ZU8 (National version for USA)	AR91.10-D-1456TS
			

 **Headless screws/bolts: screws/bolts and nuts, coarse-pitch thread**

Number	Designation		8.8	10.9
BA00.10-Z-1002-01KOA	M6	Galvanized	Nm 9	13
		Phosphated	Nm 9	12

 **Headless screws/bolts: screws/bolts and nuts, coarse-pitch thread**

Number	Designation		12.9
BA00.10-Z-1002-01KOA	M6	Galvanized	Nm 16
		Phosphated	Nm 14



Mercedes-Benz

Work instructions

---

**Van**

**Group 72**  
**CODE: VS3SCHIEBT**

**SM72.16-D-0008D**  
**17.11.2022**

**Sliding door conversion (code: VS3SCHIEBT, acc. no.: 72 951 62)**

**Model**     **907.6/7**  
**with code ZU8 (National version for USA)**  
**except code EL9 (Two-way loudspeaker system in front and rear)**  
**with electric closing assist of right sliding door**



<b>SM72.16-D-0008D</b>	<b>Sliding door conversion (code: VS3SCHIEBT, acc. no.: 72 951 62)</b>	<b>09.11.2022</b>
------------------------	--	-------------------

**Model**      **907.6/7**  
**with code ZU8 (National version for USA)**  
**except code EL9 (Two-way loudspeaker system in front and rear)**  
**with electric closing assist of right sliding door**

**Operation no. of the operation texts or standard texts and flat rates**

<b>Category</b>	<b>Op. no.</b>	<b>Operation text</b>	<b>Time</b>	<b>Damage Code</b>	<b>Code</b>
L	02 0983	Operations: Modify sliding door on vehicle with code T50, without code EL9/V40	5.0 hrs	72 951 62	VS3SCHIEBT

**Important!**

On affected vehicles, the sliding door closing assist is removed.

**Replacement parts ordering:**

Before ordering the required replacement parts, the special equipment code T50 (Electrical closing assist for right sliding door) must be removed from the Vehicle Documentation (VeDoc). Only then can the correct replacement parts can be determined using XENTRY Parts Information.

**Vehicle documentation (VeDoc):**

Changes in VeDoc can only be made by users with write permission.

If no-one with change authorization is available, a ticket must be created in the "XENTRY Support and Feedback (XSF)" system for "Vehicle data/VeDoc".

Please note that the XSF ticket has to be approved by the national organization, something which involves additional processing time.

It may take a few days for the entry to be visible in VeDoc.

**In the event of problems:**

If problems arise while carrying out the service measure, please create a PTSS case.

To do this, use the "DTS pre-case checklist".

The most recent version is always available via the XENTRY Portal.

4 Cover



D72.16-A044-72

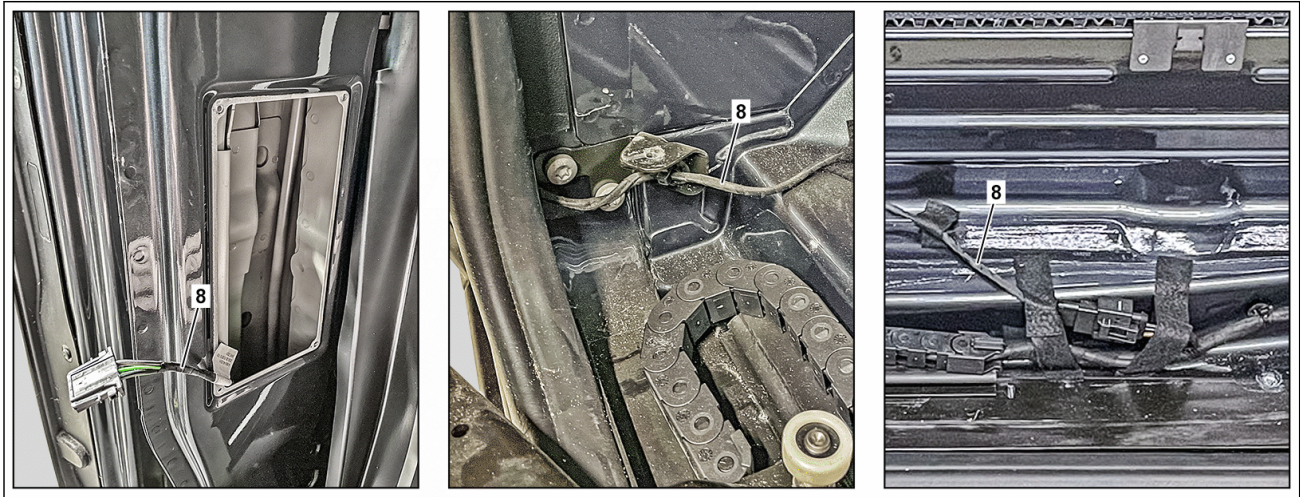



D72.16-A051-78

8 Closing assist motor electrical wiring harness

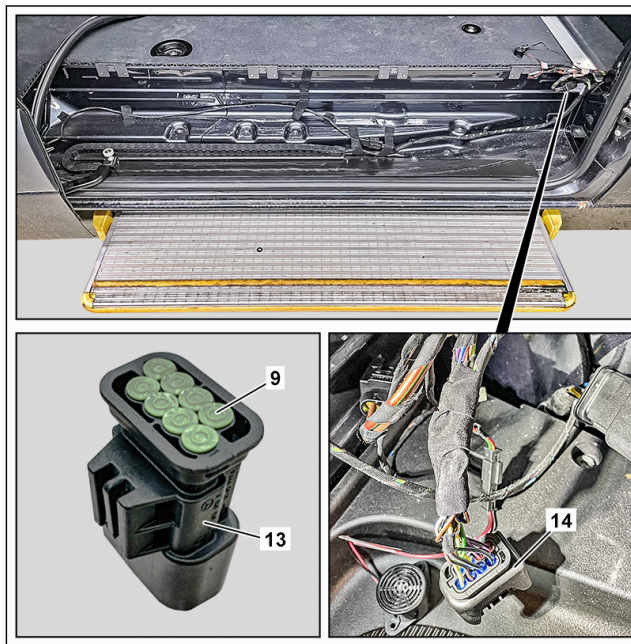











- 9 Blind plug
- 13 Connector
- 14 Connector





















D72.16-A046-82

 <b>Warning</b>	<b>Risk of injury</b> caused by fingers being jammed or pinched when removing, installing or aligning hoods, doors, trunk lid/rear-end door or sliding roof.	No parts of the body or limbs should be within the operating area when the components are moving.	AS00.00-Z-0011-01A
 <b>Caution</b>	<b>Risk of injury</b> caused by scraping or cutting body parts on sharp vehicle parts	Always wear protective gloves when working on or near sharp and non-deburred vehicle parts. Deburr repair panels.	AS00.00-Z-0017-01A
<b>Notice</b>	Information on preventing damage to electronic components due to electrostatic discharge		AH54.00-P-0001-01A
<b>Notice</b>	Notes on carrying out repair work in the vehicle interior		AH68.00-D-0001-01KOS
<b>Notice</b>	Notes on retrofitting electrical/optical lines		AH82.00-P-0000-01A
	<b>Check</b>		
1	Check if vehicle is affected by measure.		



	<b>Update Vehicle Documentation (VeDoc)</b>		
2	Remove special equipment from online vehicle data card.	 Remove existing code T50 (Electrical actuation for right sliding door).	
3	Attach "Sliding door converted as per SM72.16-D-0008D note" under field organization texts to KG72.		
	<b>Remove</b>		
4 	Detach ground line of on-board electrical system battery.		AR54.10-D-0029TS
5	Remove component parts in vehicle interior for sliding door conversion.		<a href="#">Page 24</a>
6	Remove cover(4).	 To do this, unscrew screw/bolts. Cover (4) is no longer required.	
7 	Remove closing assist motor with lock striker in C-pillar.	 The closing assist motor is no longer required.	AR72.16-D-0002TSR
8 	Remove lower guide rail for sliding door.	Model 907.6/7  The lower carriage is no longer required.	AR72.16-D-7816TS
9	Remove closing assist motor electrical subharness (8).	 To do so, unclip electrical subharness (8), guide it out of C-pillar then disconnect electrical connector.  The electrical subharness (8) is no longer required.  Clip remover	<a href="#">452 589 01 63 00</a>
10	Install blind plugs (9) into plug (13).	 A 048 545 42 28 A 000 545 78 80	
11	Connect plug (13) to plug (14).		
12	Strap down plug (14) using cable ties on factory-installed electrical wiring harness or at suitable point.	 The plug (14) is no longer required. <b>Information on wiring diagram:</b> Right sliding door electrical connector 3 (B-pillar) (100/11x3)	

	<b>Modify sliding door</b>		
13 AR	Remove electric sliding door control unit.	 The control unit is no longer required.	AR72.29-D-5898TS
14	Modify electrical wiring harness in sliding door.		<a href="#">Page 8</a>
15	Modify detachable parts on sliding door.	 Operation steps 3 to 8 of document reference.	<a href="#">Page 8</a>
	<b>Retrofit wiring harness in vehicle interior</b>		
16 PE	Fabricate wiring harness for sliding door. Wiring diagram for sliding door	 Wiring harness repair kit, basic	PE72.16-D-2001LAA <a href="#">Page 19</a> 000 589 13 99 00
17 WS AR PE	Retrofit wiring harness for sliding door. 000 588 00 84 00 Heat gun Repairing wiring harness using solder connectors Wiring diagram for sliding door	 Reflector  Adapter  Wiring harness repair kit, basic	WS54.00-P-0049B AR00.19-P-0100-09A PE72.16-D-2001LAA <a href="#">Page 12</a> 220 589 01 99 41 220 589 01 99 42 000 589 13 99 00
	<b>Install</b>		
18 AR	Install new lower sliding door carriage.	Model 907.6/7	AR72.16-D-7844TS
19 AR	Install lower guide rail for sliding door.	Model 907.6/7	AR72.16-D-7816TS
20	Retrofit reinforcement for lock striker in C-pillar.		<a href="#">Page 22</a>
21	Install removed component parts in vehicle interior for sliding door conversion.		<a href="#">Page 24</a>
22 AR	Connect ground line of on-board electrical system battery.		AR54.10-D-0029TS

	<b>SCN coding</b>		
23  AD	Connect diagnostic system.	 It is absolutely essential to precisely follow the operation steps as described in the vehicle diagnosis system.	AD00.00-D-2000-06TS
24  AR	Connect charging equipment.	 During the entire work procedure a sufficiently large voltage supply must be provided for the vehicle's on-board electrical system. Otherwise any undervoltage that occurs may damage the control units.  Follow the operating instructions for the charger.  Use the charger to ensure that an adequate power supply (min. 12.5 V) is provided for the on-board electrical system battery.	AR54.10-D-1127TS
25  AR	Perform SCN coding on signal acquisition and actuation module (SAM) control unit.	 Under the "Control unit adaptations" menu item, follow the instructions for "SCN coding".	AR54.21-D-0015TS
26  AR	Remove charger from vehicle.		AR54.10-D-1127TS
	<b>Check</b>		
27	Check sliding door for correct opening and closing.	 See Operator's Manual.	

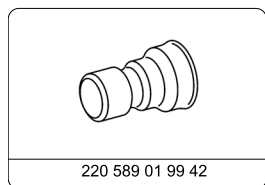

Adapter

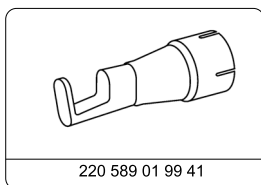

Reflector

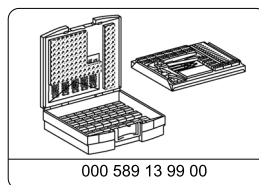
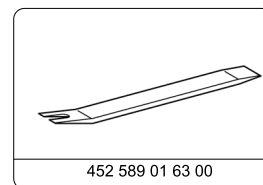
Wiring harness repair  
kit, basic

Clip remover

**Parts ordering note**

Part no.	Designation	Quantity
A 906 630 33 00	C-pillar	1
A 906 720 02 04	Lock striker	1
A 000 984 31 29	Screw	2
A 000 995 51 14	Line fastener	5
N 000000 000455	Screw	2
A 906 692 12 22 9051	Cover (on vehicle with code V36 Roof lining)	2
A 906 692 07 22 9051	Cover	1
A 910 998 02 50 9051	Cover plug	n. B.
A 910 998 00 50 9051	Cover plug	n. B.
A 037 545 35 28	Plug-in connector	1
A 048 545 42 28	Connector	1
A 000 545 78 80	Blind plug	12
	Parts for electrical wiring harness:	
	Electric lines (available on free market, observe specifications)	4
A 013 545 76 26	Female contact	1
A 001 982 57 02	Cable lug (ground connection)	1
A 009 545 81 26	Female contact	4
A 037 545 34 28	Connector	1
A 000 995 25 94	Cable tie	n. B.

SM72.16-D-0008-01SGB	Convert sliding door (code: VS3SCHIEBT, acc. no.: 72 951 62)		
----------------------	--	--	--

**Model 907.6/7**  
**with code ZU8 (National version for USA)**  
**with electric closing assist of right sliding door**

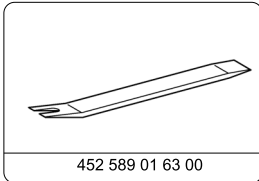

Clip remover

#### Refit electrical wiring harness

Shown on model 907.7 with code EL9 (2-way speaker system, front and rear)

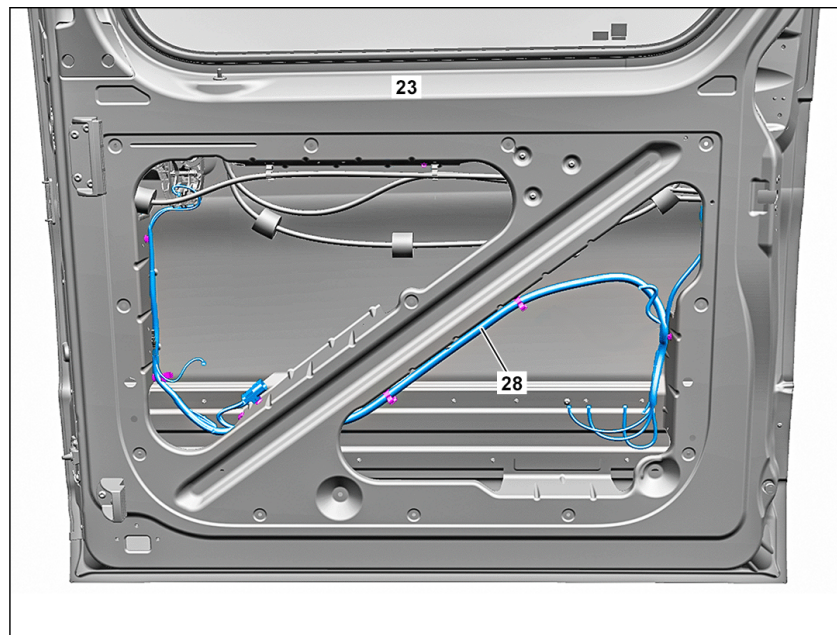

D72.16-A049-76

- 1 Remove electrical wiring harness (28).



To do so, unclip electrical wiring harness (28) from sliding door (23).

The number of fastenings can vary here, depending on the equipment installed.



The electrical wiring harness (28) is no longer required.

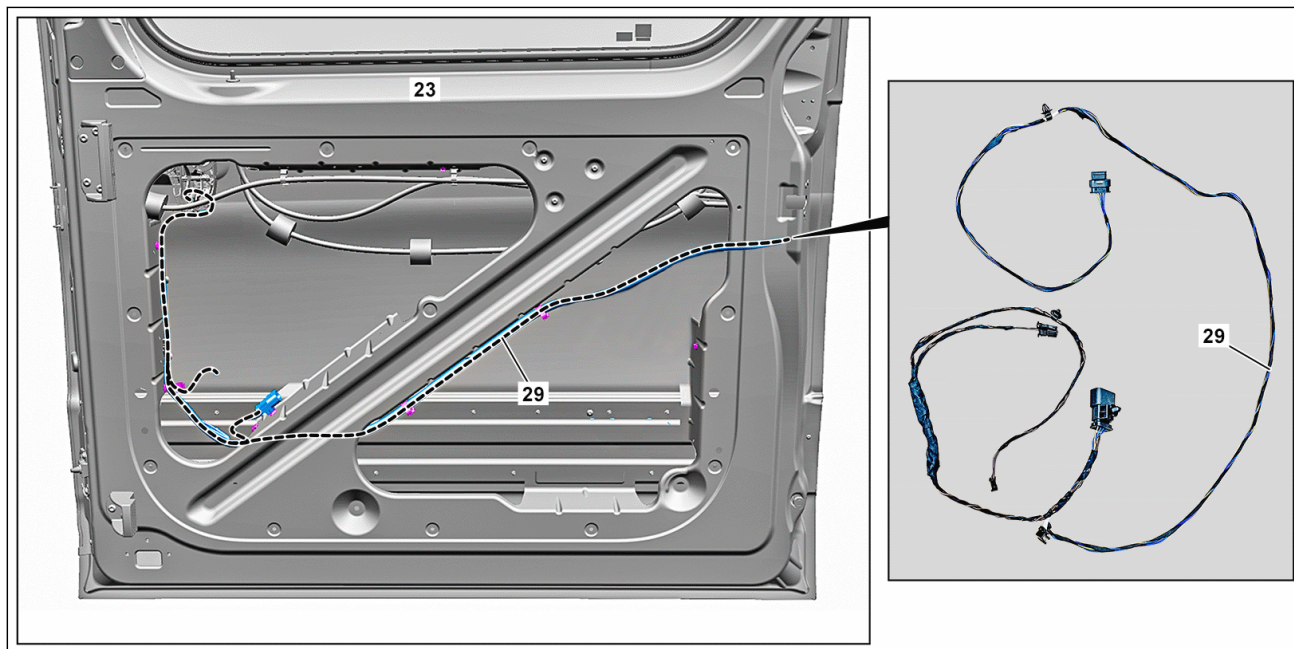

D72.16-A050-79

**Shown on model 907.7 with code EL9 (2-way speaker system, front and rear)**

- 2 Install new electrical wiring harness (29) as shown.



Order part number for electrical wiring harness (29) according to list below.



Continue in the higher-level service document.

-----  
**Modify sliding door detachable parts**

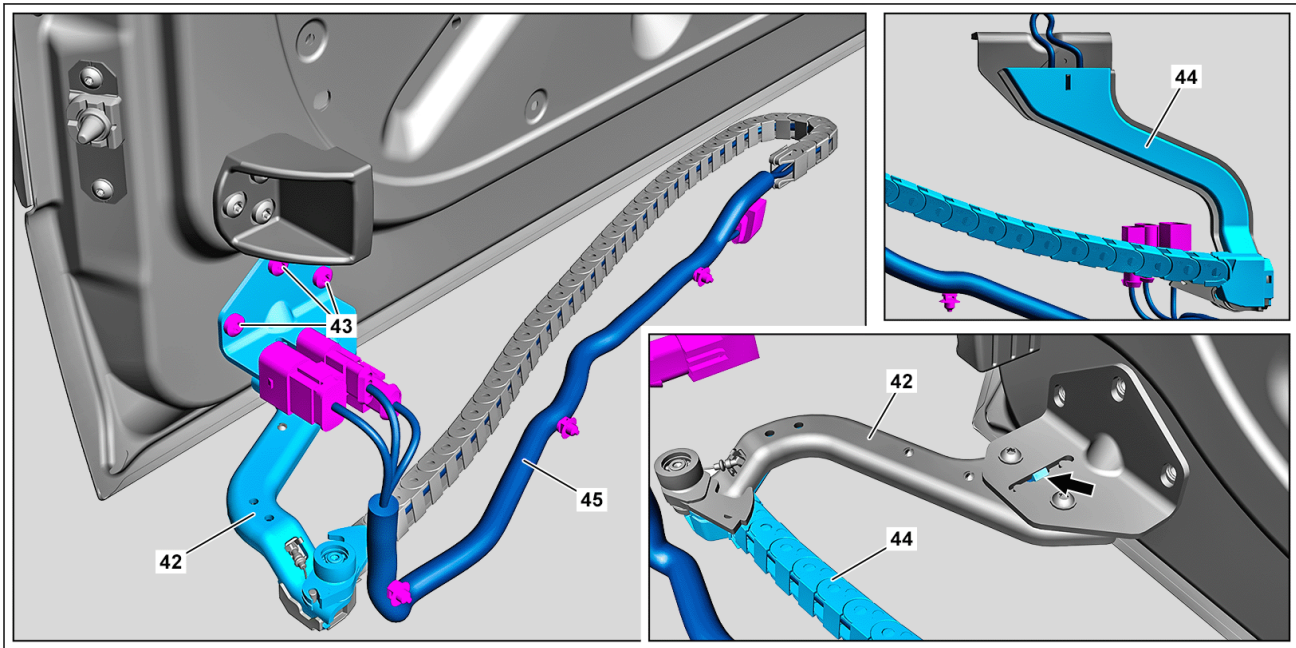

D72.16-A079-79

- 3 Remove lower carriage (42) from sliding door.



For this purpose, remove screws (43).



The removed lower carriage (42) is no longer required.

- 4 Release cable duct (44) (arrow) and remove from lower sliding carriage (42).

- 5 Remove cable duct (44) with electrical wiring harness (45).

- 6 Remove cover (46).



To do this, remove screws (47).



D72.16-A081-81

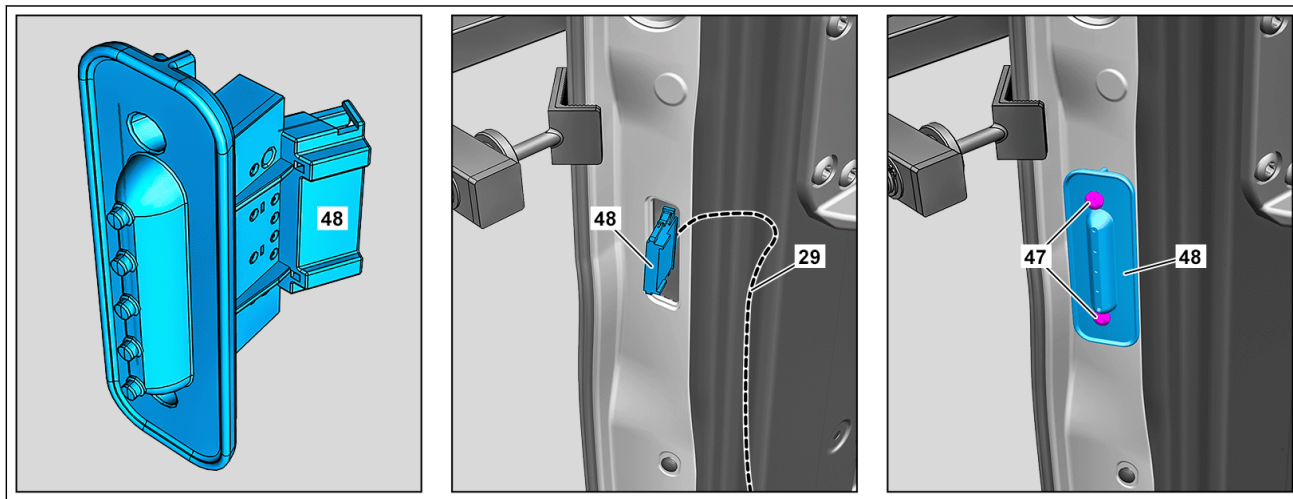

D72.16-A077-78

- 7 Connect contact switch (48) to plug connector (49) of new electrical wiring harness (29).
- 8 Install contact switch (48).



To do so, turn in screws (47).



SM72.16-D-0008-02SG	Retrofit wiring harness for sliding door (code: VS3SCHIEBT, acc. no.: 72 951 62)		
<b>Notice</b>	Information on preventing damage to electronic components due to electrostatic discharge		AH54.00-P-0001-01A
<b>Notice</b>	Notes on carrying out repair work in the vehicle interior		AH68.00-D-0001-01KOS
<b>WS</b>	000 588 00 84 00 Heat gun		WS54.00-P-0049B
<b>AR</b>	Repairing wiring harness using solder connectors		AR00.19-P-0100-09A
<b>PE</b>	Wiring diagram for sliding door		PE72.16-D-2001LAA

**Model 907.6/7**  
**with code ZU8 (National version for USA)**  
**except code EL9 (Two-way loudspeaker system in front and rear)**

**Nm** Headless screws/bolts: screws/bolts and nuts, coarse-pitch thread

Number	Designation		8.8	10.9
BA00.10-Z-1002-01KOA	M6	Galvanized	Nm 9	13
		Phosphated	Nm 9	12

**Nm** Headless screws/bolts: screws/bolts and nuts, coarse-pitch thread

Number	Designation		12.9
BA00.10-Z-1002-01KOA	M6	Galvanized	Nm 16
		Phosphated	Nm 14

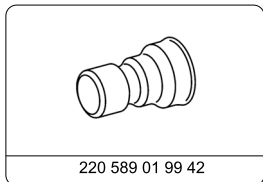

Adapter

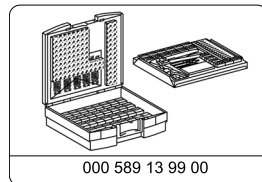

Wiring harness repair kit, basic

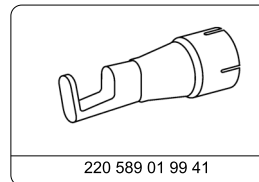

Reflector



Do not kink any electric lines and ensure that they are routed without any chafing.

This prevents any damage.

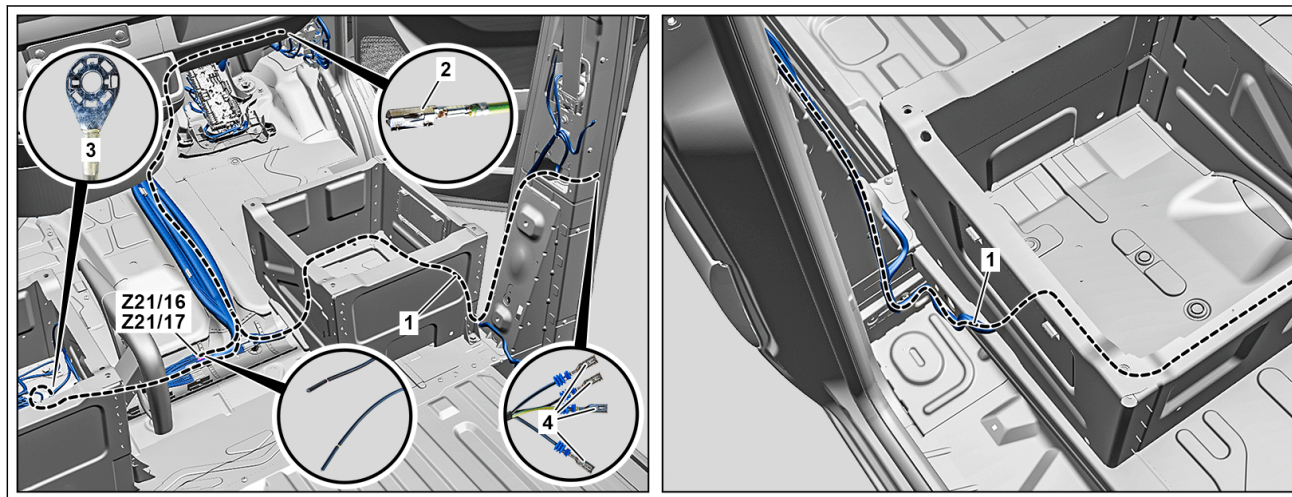

D72.16-A037-78

### Route electrical wiring harness (1)



The following specified line colors for the electric lines correspond to the series production configuration.

- 1 Route electric lines "YE/GN", "BN", "BU/BK", as shown.
- 2 Join electric lines "YE/GN", "BN", "BU/BK", "BU/BN" and wrap, section-by-section, with suitable insulation tape.



The electrical wiring harness (1) is made up of the electric lines "YE/GN", "BN", "BU/BK", "BU/BN".





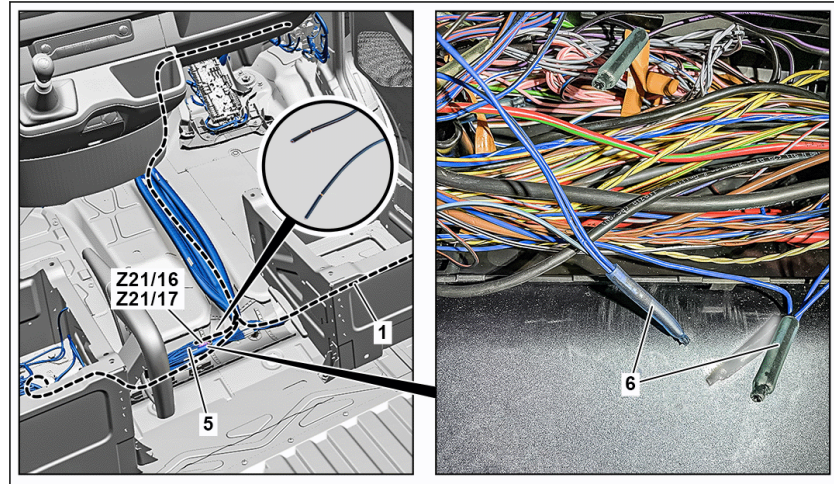

Make sure that the junctions of the electric lines "YE/GN", "BN", "BU/BK", "BU/BN" remain free at the connection end.

- 3 Loosely fasten electrical wiring harness (1) in sections at factory-installed electrical wiring harness or at a suitable position using cable ties.

### Electrical wiring harness (1) to end sleeves



D72.16-A038-75

- |   |   |
|---|---|
| <p>4</p> <p>Disconnect control circuit 1 central locking end sleeve (Z21/16) from electrical wiring harness (5).</p> <p><b>i</b><br/>Electric line "BU/BK".</p>   | <p>6</p> <p>Disconnect control circuit 1 central locking end sleeve (Z21/17) from electrical wiring harness (5).</p> <p><b>i</b><br/>Electric line "BU/BN".</p>   |
| <p>5</p> <p>Connect electric line "BU/BK" of electrical wiring harness (5) and electric line "BU/BK" of electrical wiring harness (1) to new end sleeve (6).</p> <p><b>i</b><br/>To do so, use heat gun with  reflector or  adapter.<br/> Use basic wiring harness repair kit.</p> | <p>7</p> <p>Connect electric line "BU/BN" of electrical wiring harness (5) and electric line "BU/BN" of electrical wiring harness (1) to new end sleeve (6).</p> <p><b>i</b><br/>To do so, use heat gun with  reflector or  adapter.<br/> Use basic wiring harness repair kit.</p> |

**Electrical wiring harness (1) to signal acquisition and actuation module (SAM) control unit**

- 8 Release and disconnect electrical connector (RBA1) from SAM (N10).



D72.16-A039-76

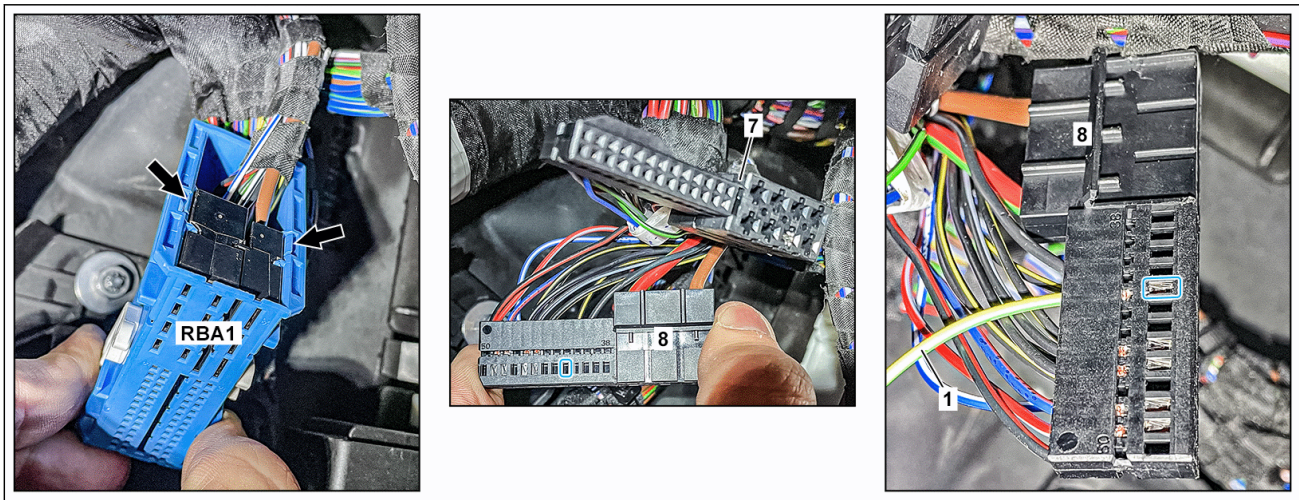

D72.16-A040-78

- 9 Disassemble electrical connector (RBA1).  
**i**  
 To do so, release plug housing (arrows A), guide out plugs (7, 8) and disconnect from each other.
- 10 Install electric line "YE/GN" of electrical wiring harness (1) into contact cavity 42 of plug (8).

- 11 Assemble electrical connector (RBA1).  
**i**  
 To do so, connect plugs (7, 8) and guide into plug housing, then lock.
- 12 Use cable ties to fasten electric line "YE/GN" directly behind plug housing of electrical connector (RBA1) to factory-installed electrical wiring harness.

- 13 Strap down extended length of electric line "YE/GN" at suitable point.

- 14 Connect electrical connector (RBA1) to SAM control unit (N10).

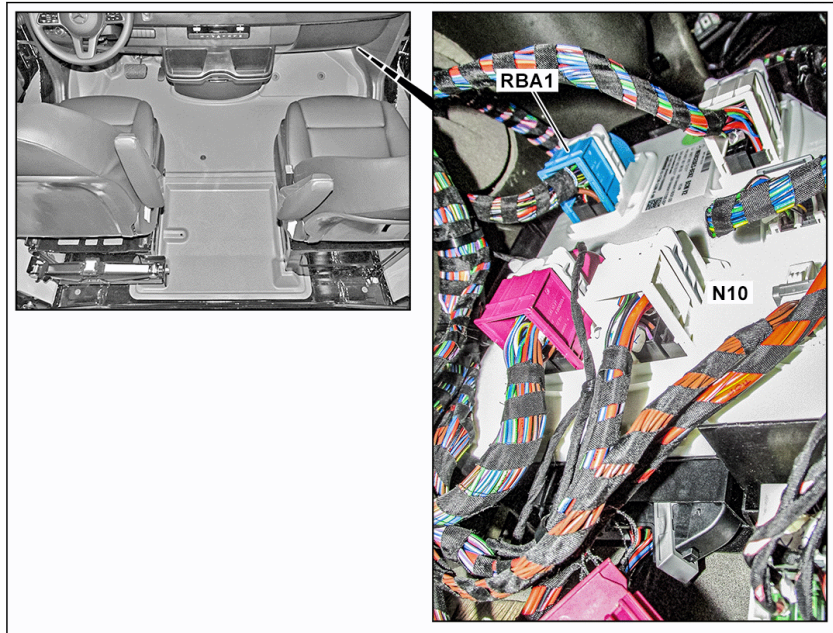

D72.16-A039-76

Electrical wiring harness (1) to "Right sliding door contact plate 1 electrical connector (X100/1)" (plug (9))

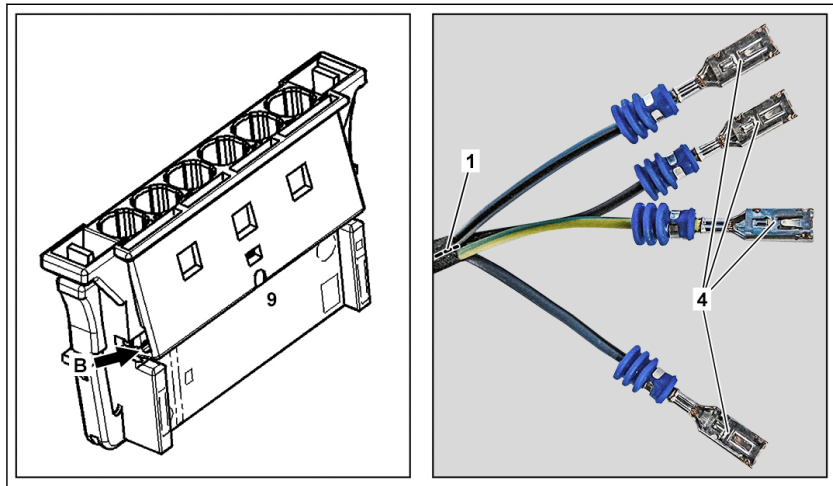

D72.16-A041-75

- 15 Release plug (9) (arrow B).



A 048 545 42 28 Plug



Contact cavity 1: Electric line "YE/GN"

Contact cavity 3: Electrical line "BN"

Contact cavity 4: Electrical line BU/BN

Contact cavity 5: Electrical line "BU/BK"

- 16 Install contact sockets (4) in plug (9).

17 Lock plug (9).

**Electrical wiring harness (1) to ground connection**

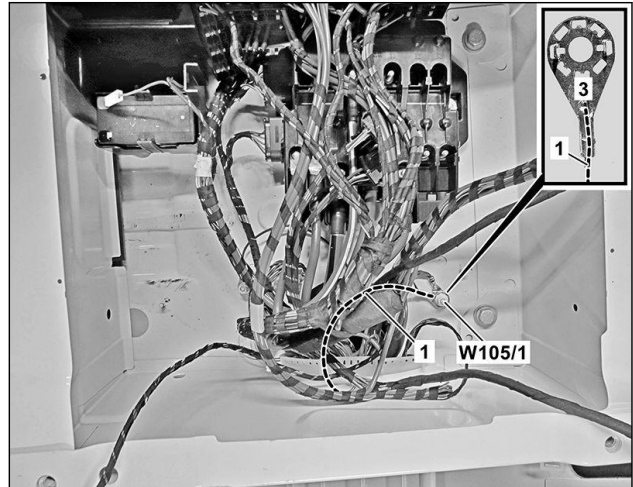

D72.16-A042-11

18 Remove nut of driver seat base ground point 1 (W105/1).

20 Attach nut of driver seat base ground point 1 (W105/1) [Nm](#).

19 Connect cable lug (3) of electrical wiring harness (1) to driver seat base ground point 1 (W105/1).

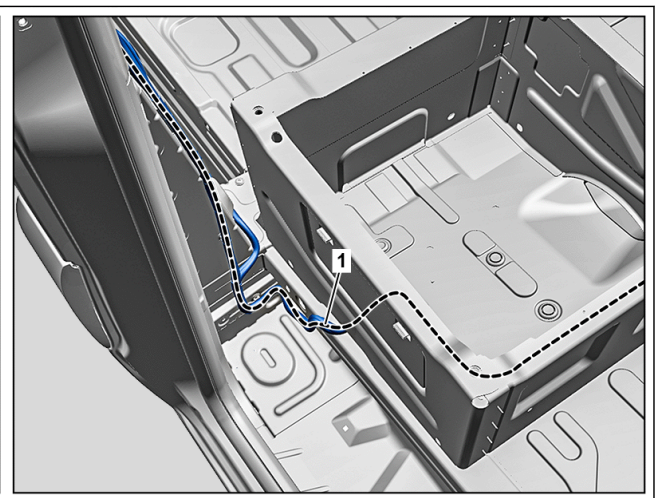
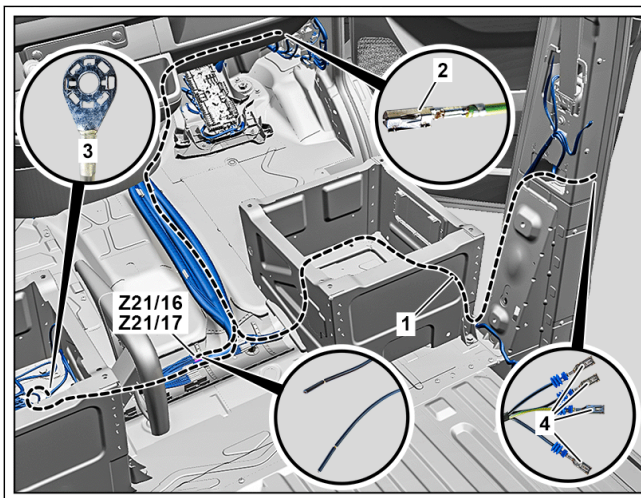

D72.16-A037-78

**Tighten electrical wiring harness (1)**

21 Tighten loosely attached cable ties on complete electrical wiring harness (1).  
If necessary,

↓  
Strap down extended length of electrical wiring harness (1) at a suitable point.

22

Install contact plate  
(38).



To do so, connect  
plug (9) and screw in  
screws.

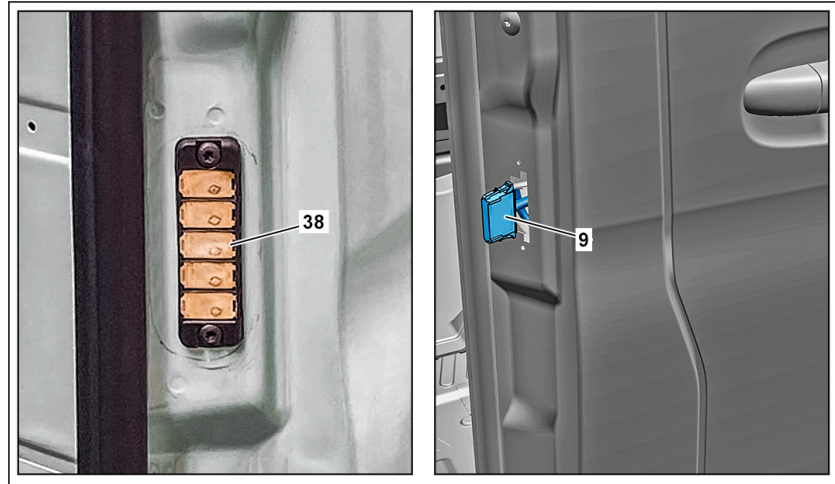

D72.16-A059-75

SM72.16-D-0008-03SG	Fabricate wiring harness for sliding door (code: VS3SCHIEBT, acc. no.: 72 951 62)		
Notice	Information on preventing damage to electronic components due to electrostatic discharge		AH54.00-P-0001-01A
Notice	Notes on carrying out repair work in the vehicle interior		AH68.00-D-0001-01KOS
Notice	Notes on retrofitting electrical/optical lines		AH82.00-P-0000-01A
PE	Wiring diagram for sliding door		PE72.16-D-2001LAA

**Model 907.6/7**  
**with code ZU8 (National version for USA)**

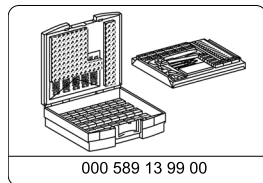

Wiring harness repair kit, basic



The following specified line colors for the electric lines correspond to the series production configuration and they can be replaced, if necessary, with similar line colors. Please ensure that electrical lines can be correctly assigned in accordance with slot assignment.



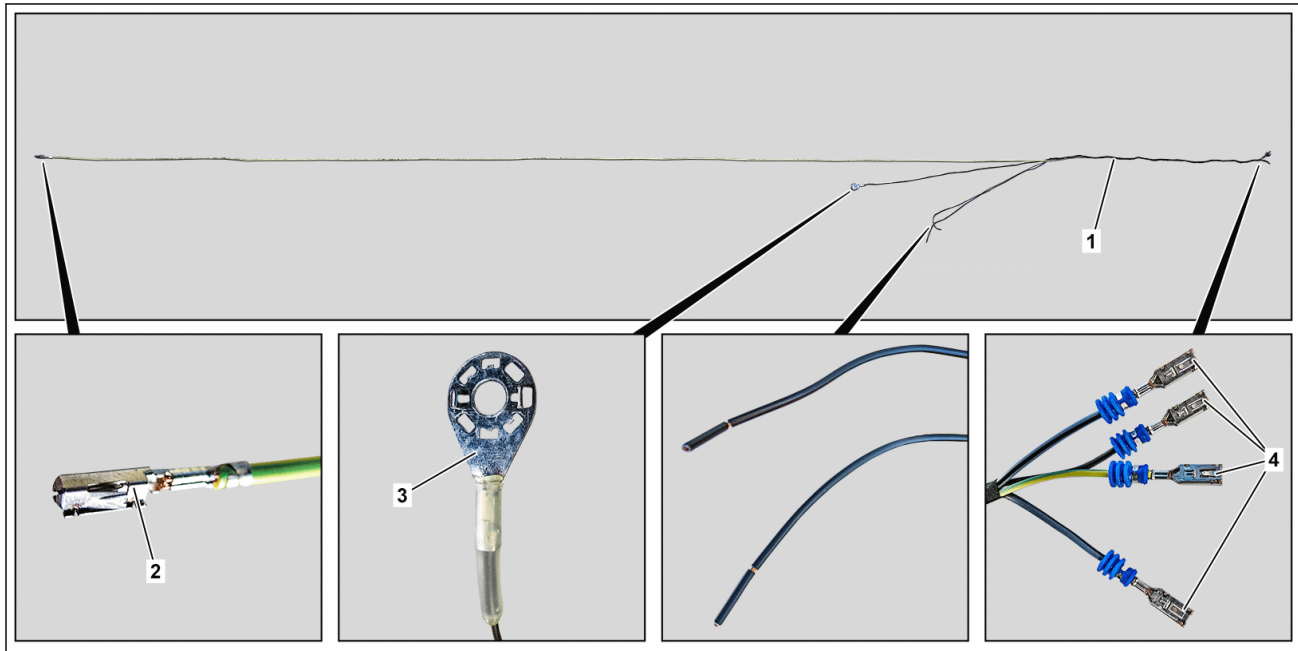

D72.16-A036-79

- |   |   |   |  |
|---|---|---|--|
| 1 | <p>Prepare electric line "YE/GN".</p> <p><b>i</b></p> <p>X100/1 to RBA1</p> <p>Line color "YE/GN"</p> <p>Length approx. 410 cm</p> <p>Cross section 0.5 mm<sup>2</sup></p>    |   | <p><b>i</b></p> <p>X100/1 to Z21/17</p> <p>Line color "BU/BN"</p> <p>Length approx. 232 cm</p> <p>Cross section 0.75 mm<sup>2</sup></p>  |
| 2 | <p>Prepare electric line "BN".</p> <p><b>i</b></p> <p>X100/1 to W105/1</p> <p>Line color "BN"</p> <p>Length approx. 255 cm</p> <p>Cross section 0.5 mm<sup>2</sup></p>        | 5 | <p>Crimp contact socket (2) onto electric line "YE/GN".</p> <p><b>i</b></p> <p> Use basic wiring harness repair kit.</p> <p><b>i</b></p> <p>A 013 545 76 26 Contact socket</p> |
| 3 | <p>Prepare electric line "BU/BK".</p> <p><b>i</b></p> <p>X100/1 to Z21/16</p> <p>Line color "BU/BK"</p> <p>Length approx. 232 cm</p> <p>Cross section 0.75 mm<sup>2</sup></p> | 6 | <p>Crimp cable lug (3) onto electric line "BN".</p> <p><b>i</b></p> <p> Use basic wiring harness repair kit.</p> <p><b>i</b></p> <p>A 001 982 57 02 Cable lug</p>              |
| 4 | <p>Prepare electric line "BU/BN".</p>   | 7 | <p>Crimp contact sockets (4) on one side onto electric lines "YE/GN", "BN", "BU/BK", "BN/BN".</p> <p><b>i</b></p> <p> Use basic wiring harness repair kit.</p>                 |



A 009 545 81 26 Contact socket

A 001 545 78 80 Seal

- 8 Attach note in online vehicle data card under field organization texts to KG72. If line colors of prepared wiring harness (1) deviate from series production configuration.



**Note:**

Line colors of retrofitted wiring harness for sliding door deviate from series production configuration.

SM72.16-D-0008-04SG	Retrofit reinforcement for lock striker in C-pillar (code: VS3SCHIEBT, acc. no.: 72 951 62)		
---------------------	---	--	--

**Model 907.6/7**  
**with code ZU8 (National version for USA)**

- 1 Remove reinforcement (38) from C-pillar new part.



To do so, bend reinforcement (38) slightly in upper area (arrow). This makes removal easier.



The new C-pillar part is not required and should be disposed of properly.

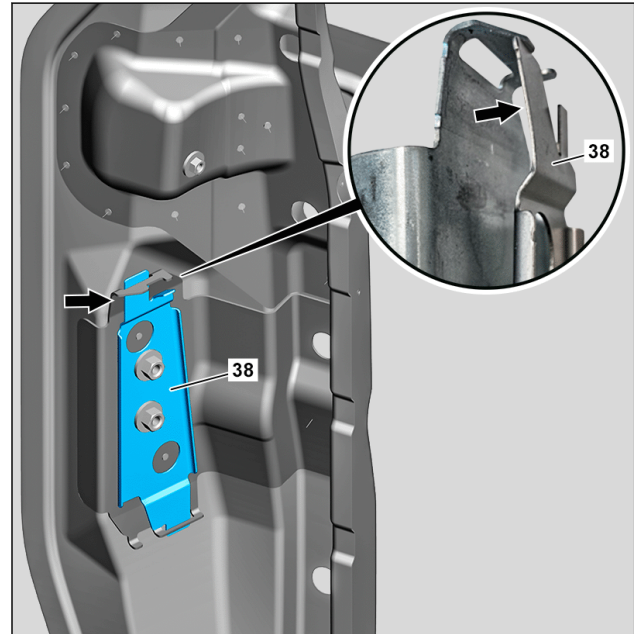

D72.16-A078-82

- 2 Install reinforcement (38) on C-pillar (40).

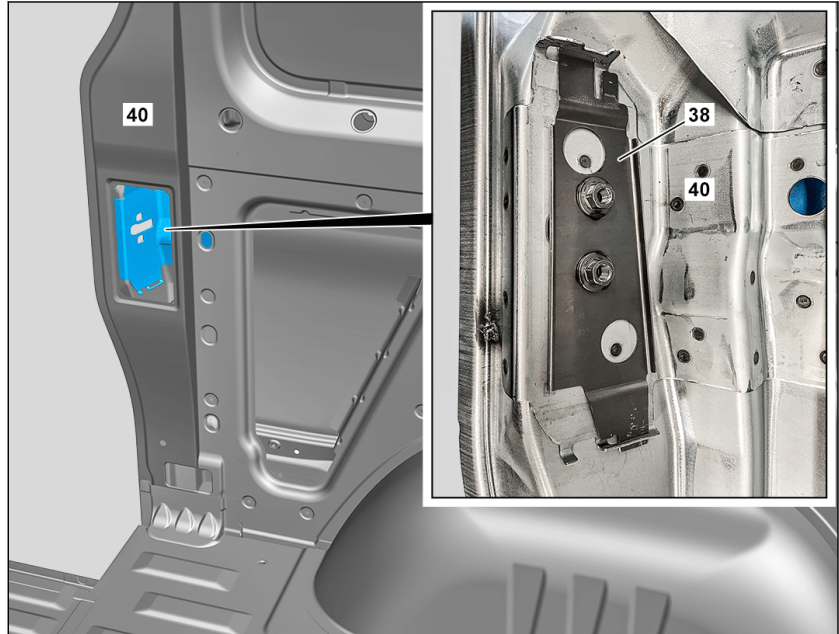

D72.16-A071-76

- 3 Install lock striker (41).



Tighten screws slightly by hand. Screws are tightened when adjusting sliding door.

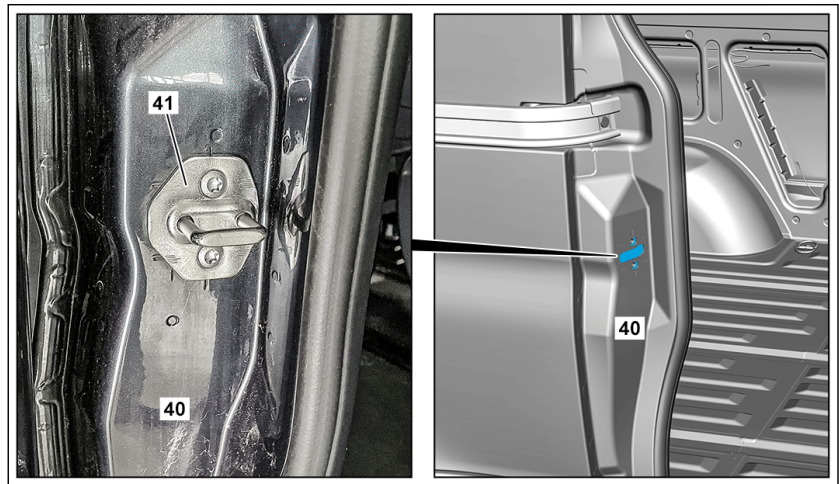

D72.16-A080-75

SM72.16-D-0009SG	Prepare vehicle interior at front for sliding door conversion (code: VS3SCHIEBT, acc. no.: 72 951 62)	18.07.2022
------------------	---	------------

**Model 907**  
**with code ZU8 (National version for USA)**

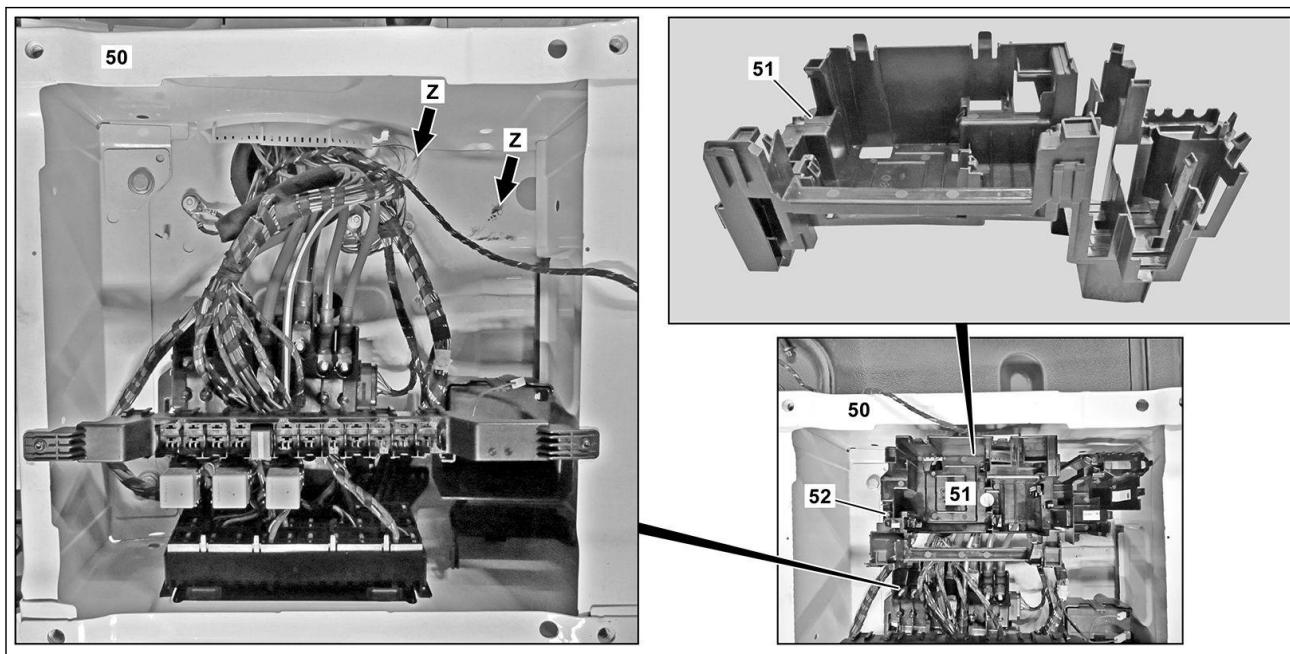

51 Control unit bracket

52 Nut

D54.21-A026-09

**Shown on model 907.7 without S23 (Front passenger bench seat)**

- 10 Cover
- 11 Nuts
- 12 Air duct







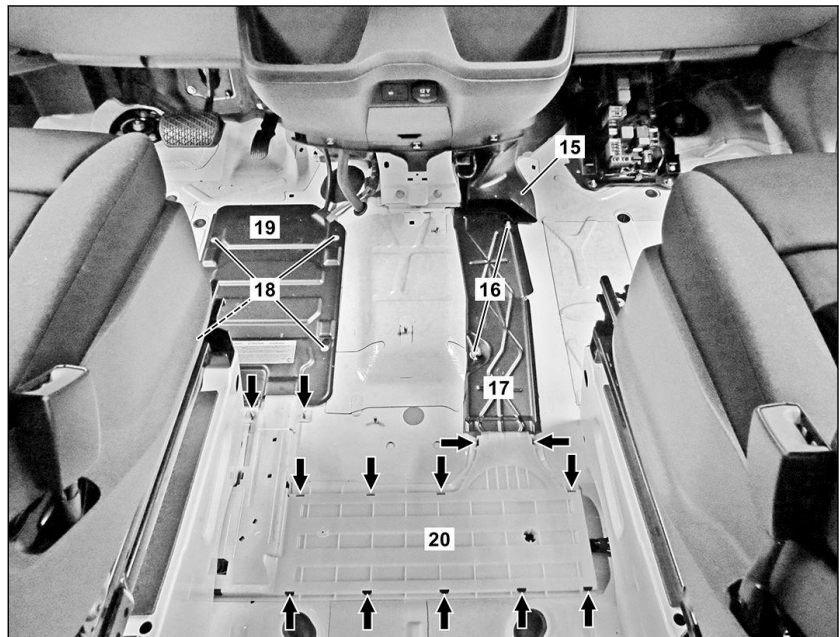

D31.19-1216-12









**Shown on model 907.7 without S23 (Front passenger bench seat)**

- 15 Air duct
- 16 Nuts
- 17 Cable duct
- 18 Bolts
- 19 Battery cover
- 20 Cover















D31.19-1217-06

 <b>Warning</b>	<b>Risk of injury</b> caused by fingers being jammed or pinched when removing, installing or aligning hoods, doors, trunk lid/rear-end door or sliding roof.	No parts of the body or limbs should be within the operating area when the components are moving.	AS00.00-Z-0011-01A
 <b>Caution</b>	<b>Risk of injury</b> caused by scraping or cutting body parts on sharp vehicle parts	Always wear protective gloves when working on or near sharp and non-deburred vehicle parts. Deburr repair panels.	AS00.00-Z-0017-01A
<b>Notice</b>	Information on preventing damage to electronic components due to electrostatic discharge		AH54.00-P-0001-01A
<b>Notice</b>	Notes on carrying out repair work in the vehicle interior		AH68.00-D-0001-01KOS
<b>Notice</b>	Notes on retrofitting electrical/optical lines		AH82.00-P-0000-01A
	<b>Remove</b>		
1.1	Remove driver seat.	Model 907  with code ZU8 (National version for USA)  except code SR8 (Swivel base for driver' seat)	AR91.10-D-1000TS
			
1.2	Remove turn plate with mounted driver's seat.	Model 907  with code SR8 (Swivel base for driver' seat)  with code ZU8 (National version for USA)   Do not separate driver's seat from turn plate.	AR91.10-D-1456TS
			
2	Remove seat base cover from driver's seat.		

3	Remove control unit holder (51).	<p>If control unit holder (51) is installed.</p> <p> To do so, remove nut (52). Position control unit holder (51) so that ground points are accessible. The number of control units varies depending on the vehicle equipment.</p> <p>If control units are installed in control unit holder (51),</p> <p style="text-align: center;">↓</p> <p>unclip control units.</p> <p> Do not disconnect plugs of control units.</p>	
4.1	Remove front passenger seat.	<p>Model 907</p> <p>with code ZU8 (National version for USA)</p> <p>except code SR9 (Swivel base for co-driver' seat)</p>	AR91.10-D-1000TS
			
4.2	Remove turn plate with installed front passenger seat.	<p>Model 907</p> <p>with code SR9 (Swivel base for co-driver' seat)</p> <p>with code ZU8 (National version for USA)</p> <p> Do not disconnect front passenger seat from turn plate.</p>	AR91.10-D-1456TS
			
5	Remove seat base cover of front passenger seat.		
6	Remove front floor coverings.		AR68.80-D-0006TSR
			
7	Remove vehicle tool kit carrier plate.		AR68.30-D-5021TS
			
8	Remove lower A-pillar trim on front passenger side.		AR68.30-D-0012TSR
			
9	Remove cover (10).		
10	Remove air duct (12).	 For this purpose, remove nuts (11).	
11	Remove air duct (15).		



12	Remove cable duct (17).	 To do so, remove nuts (16).	
13	Remove battery cover (19).	 To do so, remove screws (18).	
14	Release cover (20).	 Release cover (20) using a suitable screwdriver (arrows). Release cover (20) until wiring harness can be routed.	
	<b>Install</b>		
15	Install cover (20).		
16	Install battery cover (19).	 To do so, tighten the screws (18).	
17	Install cable duct (17).	 To do so, attach nuts (16).  M6	<a href="#">BA00.10-Z-1002-01KOA</a>
18	Install air duct (15).		
19	Install air duct (12).	 To do this, attach nuts (11).  M6	<a href="#">BA00.10-Z-1002-01KOA</a>
20	Install cover (10).		
21	Install vehicle tool kit carrier plate.		AR68.30-D-5021TS
22	Install front floor coverings.		AR68.80-D-0006TSR
23	Install lower A-pillar trim on front passenger side.		AR68.30-D-0012TSR
24	Attach control unit holder (51).	If control unit holder (51) is installed.  Do not kink subharness during installation of control unit holder (51) and ensure that it is routed free of chafing. This prevents any damage.  To do so, attach nut (52). The number of control units varies depending on the vehicle equipment.  M6 If control units are installed in control unit holder (51), ↓ clip in control units.	<a href="#">BA00.10-Z-1002-01KOA</a>
25	Install seat base cover of driver's seat.		

26.1	Install driver seat.	Model 907 with code ZU8 (National version for USA) except code SR8 (Swivel base for driver' seat)	AR91.10-D-1000TS
			
26.2	Install turn plate with driver's seat attached.	Model 907 with code SR8 (Swivel base for driver' seat) with code ZU8 (National version for USA)	AR91.10-D-1456TS
			
27	Install seat base cover of front passenger seat.		
28.1	Install front passenger seat.	Model 907 with code ZU8 (National version for USA) except code SR9 (Swivel base for co-driver' seat)	AR91.10-D-1000TS
			
28.2	Install turn plate with front passenger seat attached.	Model 907 with code SR9 (Swivel base for co-driver' seat) with code ZU8 (National version for USA)	AR91.10-D-1456TS
			

 **Headless screws/bolts: screws/bolts and nuts, coarse-pitch thread**

Number	Designation		8.8	10.9
BA00.10-Z-1002-01KOA	M6	Galvanized	Nm 9	13
		Phosphated	Nm 9	12

 **Headless screws/bolts: screws/bolts and nuts, coarse-pitch thread**

Number	Designation		12.9
BA00.10-Z-1002-01KOA	M6	Galvanized	Nm 16
		Phosphated	Nm 14

