

Technical Service Bulletin

Mazda North American Operations
Irvine, CA 92618-2922



Subject: CENTER DISPLAY OPERATES BY ITSELF (GHOST TOUCH, SURFACE PEELING, WHITE DOTS)	Bulletin No.: 09-003/23
	Last Issued : 01/03/2023

BULLETIN NOTES

This bulletin supersedes the previously issued bulletin(s) listed below. The changes are noted in Red.

Previous TSBs:	Date(s) Issued:
09-036/22	09/09/22

APPLICABLE MODEL(S)/VINS:

2016- 2017 Mazda2 (Mexico/Puerto Rico)

2019-2021 Mazda2 (Mexico/Puerto Rico) with VINS lower than 3MDDJ*****409029 (produced before July 14, 2021)

2022 Mazda2 (Mexico) with VINS lower than 3MDDJ*****452968 (produced before February 3, 2022)

2016-2017 CX-3

2019-2022 CX-3 with VINS lower than JM1DK*****604871 (produced before April 28, 2022)

2016-2017 MX-5

2020-2022 MX-5

DESCRIPTION

Some customers may complain about infotainment center display:

- Center display touchscreen operates by itself (Ghost Touch).
- The film of the center display may be peeled off.
- White dots may appear on the center display

NOTE: The occurrence of the symptoms depends on the vehicle model and the parts.

CONSUMER NOTICE: The information and instructions in this bulletin are intended for use by skilled technicians. Mazda technicians utilize the proper tools/ equipment and take training to correctly and safely maintain Mazda vehicles. These instructions should not be performed by "do-it-yourselfers." Customers should not assume this bulletin applies to their vehicle or that their vehicle will develop the described concern. To determine if the information applies, customers should contact their nearest authorized Mazda dealership. Mazda North American Operations reserves the right to alter the specifications and contents of this bulletin without obligation or advance notice. All rights reserved. No part of this bulletin may be reproduced in any form or by any means, electronic or mechanical---including photocopying and recording and the use of any kind of information storage and retrieval system ---without permission in writing.

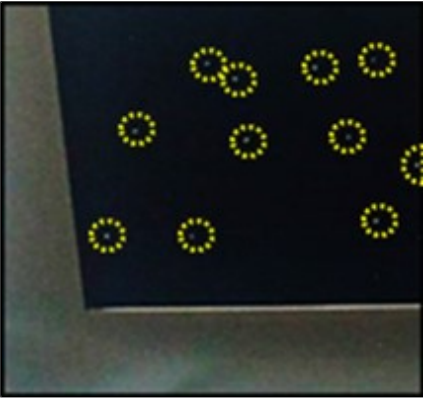
<ul style="list-style-type: none"> • Ghost Touch 	(Touch screen operates by itself)
Peeling of the film surface of the center display	
White dots on the center display	

Repair kits are available to replace just the screen. There is no need to replace the entire infotainment display unit.

Customers having this concern should have their vehicle repaired using the following repair procedure.

REPAIR PROCEDURE

1. Verify customer concern
2. Remove the center display.

NOTE: Wear the rubber gloves to protect the center display lens kit and to prevent static electricity.

3. Verify the part number on the label of the center display and ensure that the replacement kit part number is correct.

4. Place the cushion sheet that the lens is wrapped on a working table.

NOTE: This cushion sheet contains an antistatic agent that not only prevents parts from being scratched, but also prevents static electricity.

5. Replace the lens (inner part) with the modified one.

CONSUMER NOTICE: The information and instructions in this bulletin are intended for use by skilled technicians. Mazda technicians utilize the proper tools/ equipment and take training to correctly and safely maintain Mazda vehicles. These instructions should not be performed by "do-it-yourselfers." Customers should not assume this bulletin applies to their vehicle or that their vehicle will develop the described concern. To determine if the information applies, customers should contact their nearest authorized Mazda dealership. Mazda North American Operations reserves the right to alter the specifications and contents of this bulletin without obligation or advance notice. All rights reserved. No part of this bulletin may be reproduced in any form or by any means, electronic or mechanical---including photocopying and recording and the use of any kind of information storage and retrieval system ---without permission in writing.

Repair parts set:

No.	Description	Qty.	Notes
(1)	Center display lens kit	1	Cushion materials for packaging are used as work mat to protect parts from static electricity and scratches. Parts number: Refer to PARTS INFORMATION.
(2)	Rubber gloves	1	Antistatic



(1) Center display lens



(2) Rubber gloves

NOTE:

- Center display lens is packaged by a bubble wrap (3) and a cushion material (4). Unwrap the package carefully so that the packaging materials is used as an antistatic work mat.
- Unwrap the center display lens gently to avoid damaging the cable (5) (FPC: Flexible Printed Circuit) equipped on the lens.

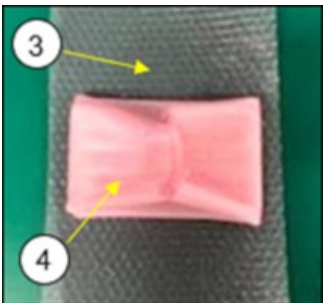

(3) Bubble wrap

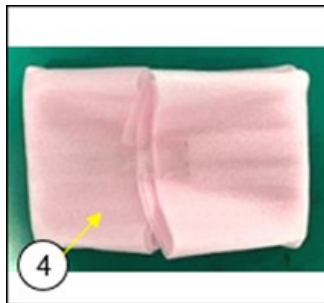

(4) Cushion material

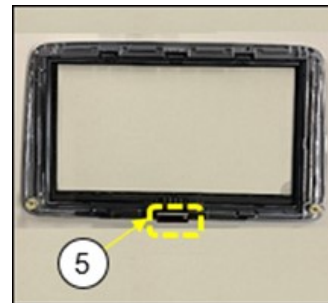

(5) Cable: Flexible Printed Circuit

CENTER DISPLAY DISASSEMBLY:

1. Remove the center display according to the instructions on MGSS.

- Mazda2: CENTER DISPLAY REMOVAL/INSTALLATION
- CX-3: CENTER DISPLAY REMOVAL/INSTALLATION
- MX-5: CENTER DISPLAY REMOVAL/INSTALLATION

CONSUMER NOTICE: The information and instructions in this bulletin are intended for use by skilled technicians. Mazda technicians utilize the proper tools/ equipment and take training to correctly and safely maintain Mazda vehicles. These instructions should not be performed by "do-it-yourselfers." Customers should not assume this bulletin applies to their vehicle or that their vehicle will develop the described concern. To determine if the information applies, customers should contact their nearest authorized Mazda dealership. Mazda North American Operations reserves the right to alter the specifications and contents of this bulletin without obligation or advance notice. All rights reserved. No part of this bulletin may be reproduced in any form or by any means, electronic or mechanical--including photocopying and recording and the use of any kind of information storage and retrieval system ---without permission in writing.

Mazda2/CX-3 Repair

1. Check the part number (2) on the label (1) of the center display and then confirm the new replacement part number in the Parts Information.

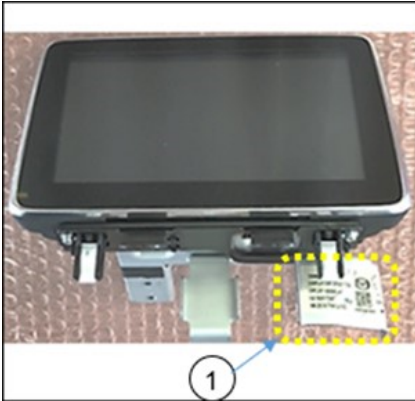

(1) Label

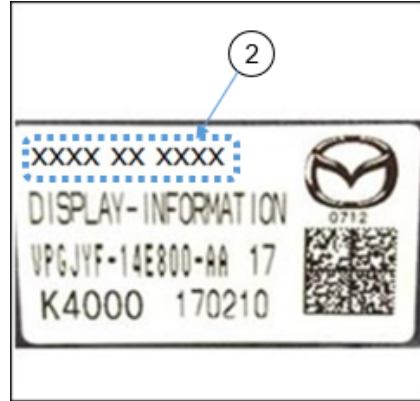

(2) Part number

2. Remove the 4 screws (1), then remove the connectivity master unit (CMU) (2) from the center display (3).

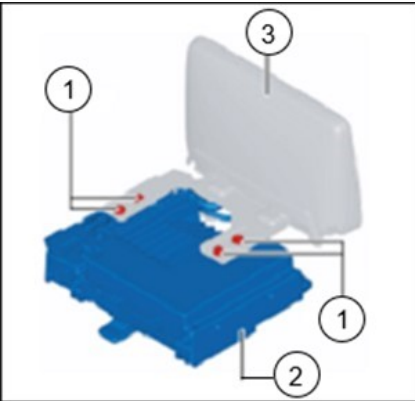

3. Place the cushion sheet (1) that the lens was wrapped in, on a workbench.

4. Put on the rubber gloves.

5. Place the center display (2) on the cushion sheet (1) with the display side facing downward.

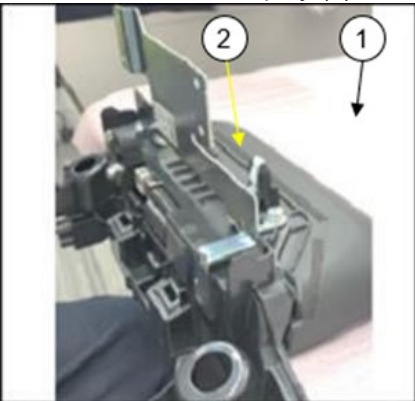

CONSUMER NOTICE: The information and instructions in this bulletin are intended for use by skilled technicians. Mazda technicians utilize the proper tools/ equipment and take training to correctly and safely maintain Mazda vehicles. These instructions should not be performed by "do-it-yourselfers." Customers should not assume this bulletin applies to their vehicle or that their vehicle will develop the described concern. To determine if the information applies, customers should contact their nearest authorized Mazda dealership. Mazda North American Operations reserves the right to alter the specifications and contents of this bulletin without obligation or advance notice. All rights reserved. No part of this bulletin may be reproduced in any form or by any means, electronic or mechanical---including photocopying and recording and the use of any kind of information storage and retrieval system ---without permission in writing.

6. Remove the 2 screws (1). Separate the center display (2) and the bracket A (3).

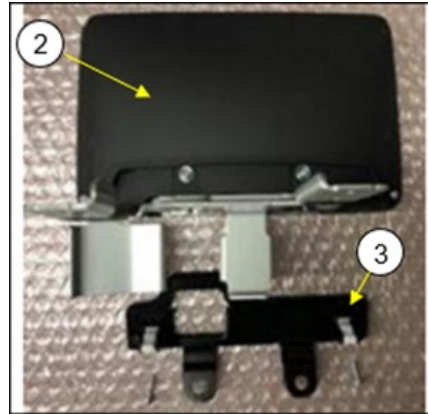
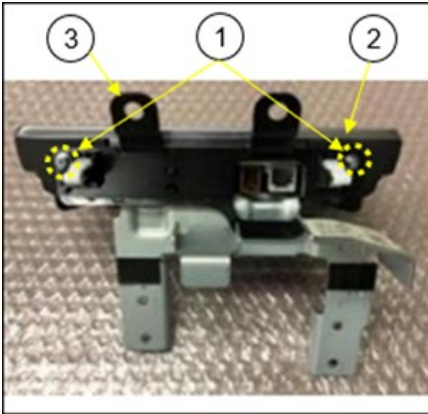

NOTE: After screwing together the center display and the bracket A (3), check that the screws (1) are seated properly, and then retighten them. (Screw: M3 x 16 mm with a washer)

7. Remove the 4 screws (1) on backside of the center display (2), unhook the 4 snap-fits (3), then remove the rear cover (4) from the center display (2).

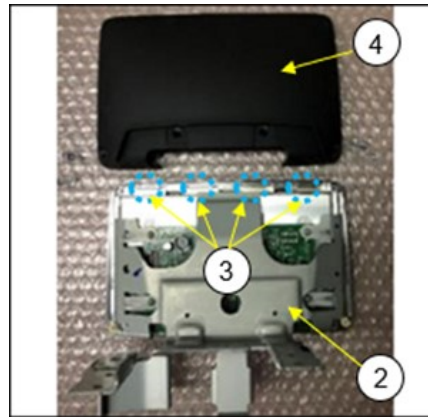
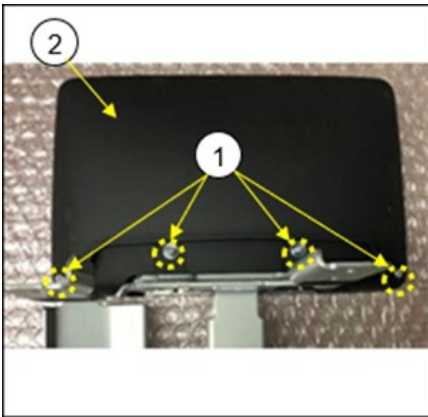

NOTE:

- When installing the rear cover (4) to the center display (2), apply the 4 snap-fits (3) properly.
- After screwing together the center display (2) and the rear cover (4), check that the screws (1) are seated properly and then retighten them. (Screw: center: M3 x 16 mm with washer, outside: M3 x 15 mm)

CONSUMER NOTICE: The information and instructions in this bulletin are intended for use by skilled technicians. Mazda technicians utilize the proper tools/ equipment and take training to correctly and safely maintain Mazda vehicles. These instructions should not be performed by "do-it-yourselfers." Customers should not assume this bulletin applies to their vehicle or that their vehicle will develop the described concern. To determine if the information applies, customers should contact their nearest authorized Mazda dealership. Mazda North American Operations reserves the right to alter the specifications and contents of this bulletin without obligation or advance notice. All rights reserved. No part of this bulletin may be reproduced in any form or by any means, electronic or mechanical---including photocopying and recording and the use of any kind of information storage and retrieval system ---without permission in writing.

8. Remove the 4 screws (1) that attach the center display (2) and the bracket B (3).

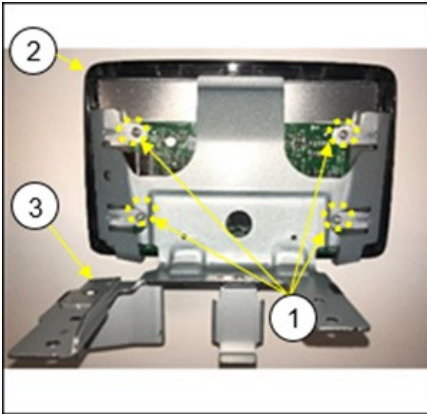

NOTE: After screwing together the bracket B (3) and the center display (2), check that the screws (1) are seated properly. (Screw: M3 x 9 mm)

9. Remove the bracket B (1) from the center display (2).

NOTE: There are 2 snap-fits (3) on the left and right side of the center display.

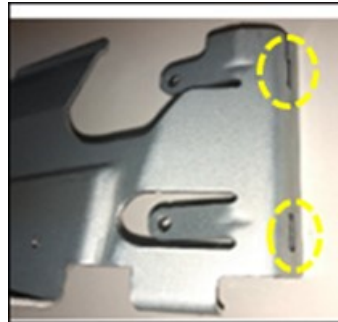
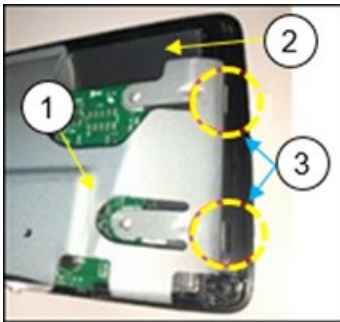

Assembly of the center display and the bracket B

Holes of the bracket B

Hooks on the center display

10. Insert a tip of a flathead screwdriver in the underside of the gap (2), and then move up the bracket B (1) partially.

NOTE: When inserting the screwdriver, be careful NOT to damage the circuit board.

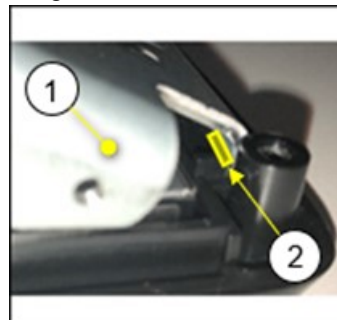
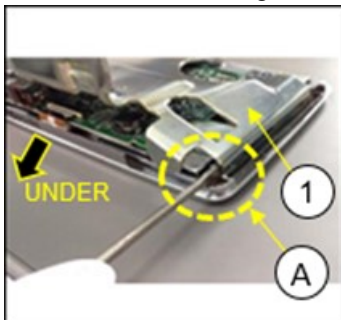

DETAIL A

Insert a flathead screwdriver.

CONSUMER NOTICE: The information and instructions in this bulletin are intended for use by skilled technicians. Mazda technicians utilize the proper tools/ equipment and take training to correctly and safely maintain Mazda vehicles. These instructions should not be performed by "do-it-yourselfers." Customers should not assume this bulletin applies to their vehicle or that their vehicle will develop the described concern. To determine if the information applies, customers should contact their nearest authorized Mazda dealership. Mazda North American Operations reserves the right to alter the specifications and contents of this bulletin without obligation or advance notice. All rights reserved. No part of this bulletin may be reproduced in any form or by any means, electronic or mechanical--including photocopying and recording and the use of any kind of information storage and retrieval system ---without permission in writing.

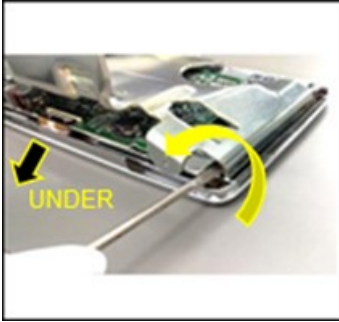

11. Insert a tip of a flathead screwdriver in upper side of the gap (1), then remove the bracket.

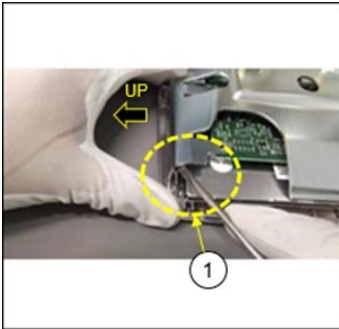

Bracket B



Center display

12. Pull up the lock tab (1) to unlock the connector.

NOTE: Pull the lock tab (1) gently to avoid the lock tab to be damaged.

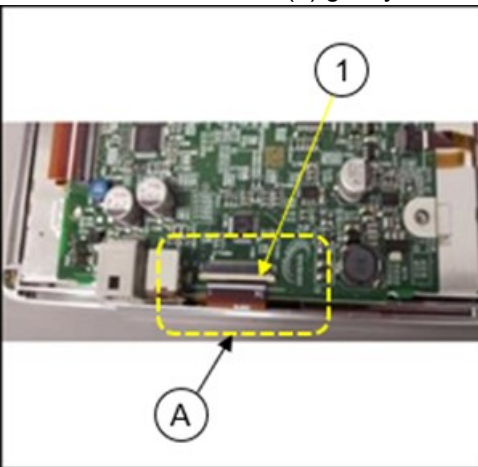

CONSUMER NOTICE: The information and instructions in this bulletin are intended for use by skilled technicians. Mazda technicians utilize the proper tools/ equipment and take training to correctly and safely maintain Mazda vehicles. These instructions should not be performed by "do-it-yourselfers." Customers should not assume this bulletin applies to their vehicle or that their vehicle will develop the described concern. To determine if the information applies, customers should contact their nearest authorized Mazda dealership. Mazda North American Operations reserves the right to alter the specifications and contents of this bulletin without obligation or advance notice. All rights reserved. No part of this bulletin may be reproduced in any form or by any means, electronic or mechanical---including photocopying and recording and the use of any kind of information storage and retrieval system ---without permission in writing.

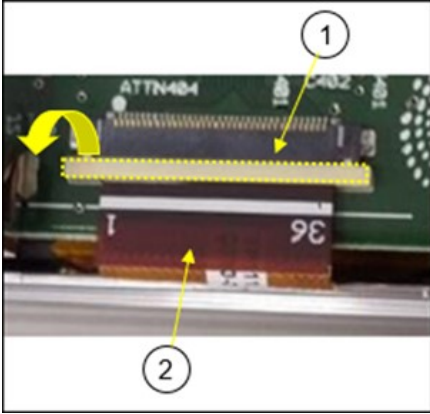

Lock:

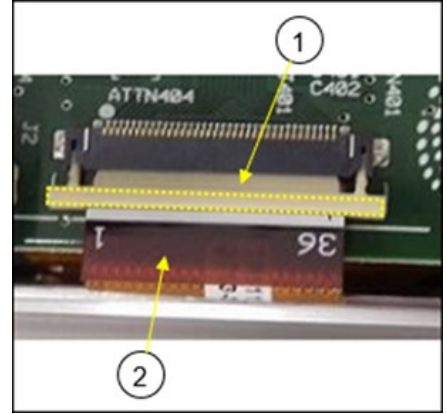

Unlock

DETAIL A
(1) Lock tab (2) Cable

NOTE: After locking the lock tab (1), check that the line of the cable (2) and the line of the circuit board (3) are aligned.

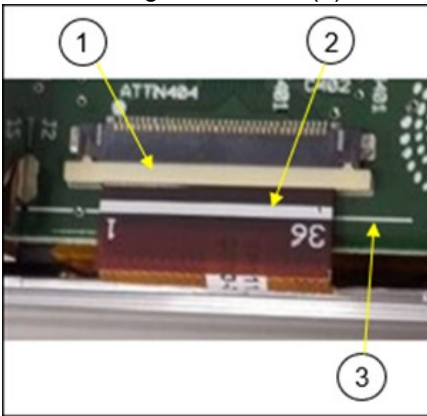

13. Hold both edges of the cable, then pull it out.

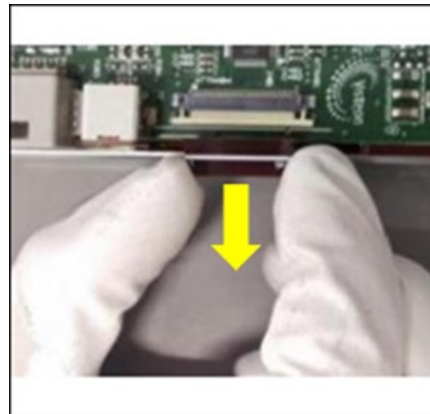
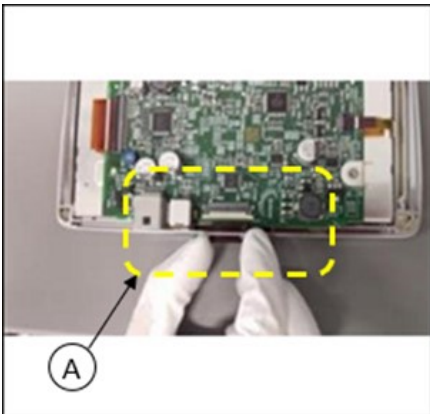

DETAIL A

CONSUMER NOTICE: The information and instructions in this bulletin are intended for use by skilled technicians. Mazda technicians utilize the proper tools/ equipment and take training to correctly and safely maintain Mazda vehicles. These instructions should not be performed by "do-it-yourselfers." Customers should not assume this bulletin applies to their vehicle or that their vehicle will develop the described concern. To determine if the information applies, customers should contact their nearest authorized Mazda dealership. Mazda North American Operations reserves the right to alter the specifications and contents of this bulletin without obligation or advance notice. All rights reserved. No part of this bulletin may be reproduced in any form or by any means, electronic or mechanical--including photocopying and recording and the use of any kind of information storage and retrieval system ---without permission in writing.

NOTE: Hold both edges of the cable and insert the cable carefully so that the cable will not be damaged.

14. Remove the center display from the lens.

15. Replace the lens with the modified one, reusing the center display.

NOTE:

- When installing the center display to the modified lens, clear foreign objects and contamination on the lens and the center display.
- When installing the center display to the modified lens, check that a gasket has been installed to the lens properly.



Replace: Lens



Reuse: Center display

16. Assemble the center display in the reverse order of disassemble.

NOTE:

- Hold both edges of the cable and insert the cable carefully so that the cable will not be damaged.
- After locking the lock tab, check that the line of the circuit board (1) and the line of the cable are aligned.
- When installing the bracket B to the center display, apply the 4 snap-fits properly.
- After screwing together the bracket B and the center display, check that the screws are seated properly. [Screw] M3 x 9 mm 4 pcs.
- When installing the rear cover the center display assy., apply the 4 snap-fits properly.
- After screwing together the center display assy. and the rear cover, check that the screws are seated properly, and then retightening them. [Screw] center: M3 x 16 mm with washer 2 pcs., outside: M3 x 15 mm 2 pcs.
- After screwing together the center display assy. and the bracket A, check that the screws are seated properly, and then retightening them. [Screw] M3 x 16 mm with washer 2 pcs.

17. Install the center display in the reverse order of removal.

18. Verify the repair.

CONSUMER NOTICE: The information and instructions in this bulletin are intended for use by skilled technicians. Mazda technicians utilize the proper tools/ equipment and take training to correctly and safely maintain Mazda vehicles. These instructions should not be performed by "do-it-yourselfers." Customers should not assume this bulletin applies to their vehicle or that their vehicle will develop the described concern. To determine if the information applies, customers should contact their nearest authorized Mazda dealership. Mazda North American Operations reserves the right to alter the specifications and contents of this bulletin without obligation or advance notice. All rights reserved. No part of this bulletin may be reproduced in any form or by any means, electronic or mechanical--including photocopying and recording and the use of any kind of information storage and retrieval system ---without permission in writing.

MX-5 Repair

1. Check the part number (2) on the label (1) of the center display and then confirm the new replacement part number in the Parts Information.

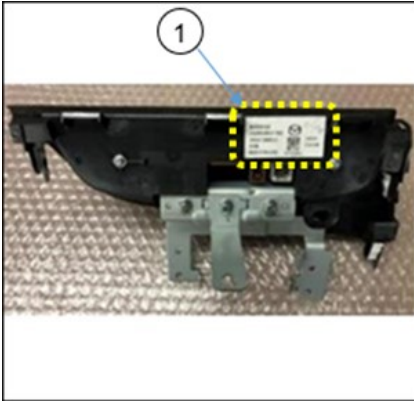

(1) Label

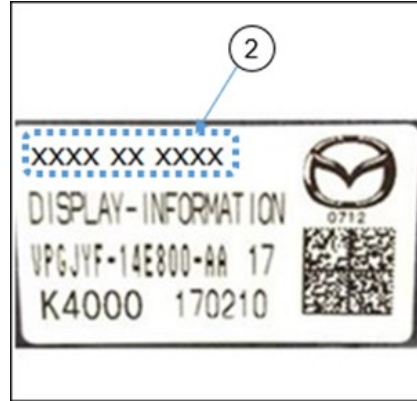

(2) Part number

2. Remove the 4 screws (1), then remove the connectivity master unit (CMU) (2) from the center display (3).

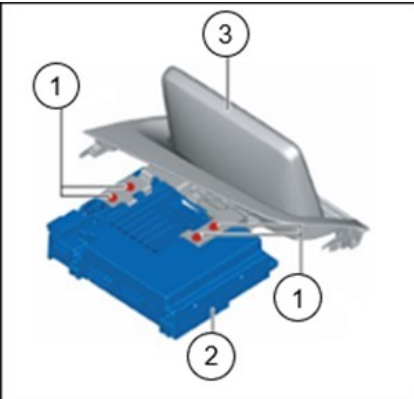

3. Place the cushion sheet (1) that the lens was wrapped in, on a workbench.

4. Put on the rubber gloves.

5. Place the center display (2) on the cushion sheet (1) with the display side facing downward.

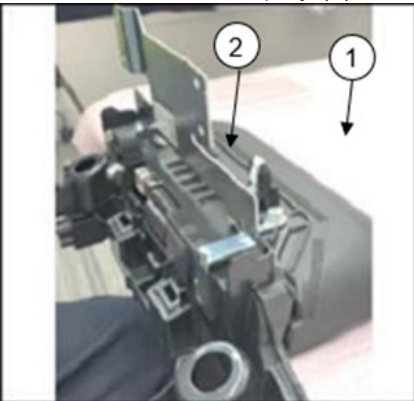

CONSUMER NOTICE: The information and instructions in this bulletin are intended for use by skilled technicians. Mazda technicians utilize the proper tools/ equipment and take training to correctly and safely maintain Mazda vehicles. These instructions should not be performed by "do-it-yourselfers." Customers should not assume this bulletin applies to their vehicle or that their vehicle will develop the described concern. To determine if the information applies, customers should contact their nearest authorized Mazda dealership. Mazda North American Operations reserves the right to alter the specifications and contents of this bulletin without obligation or advance notice. All rights reserved. No part of this bulletin may be reproduced in any form or by any means, electronic or mechanical---including photocopying and recording and the use of any kind of information storage and retrieval system ---without permission in writing.

6. Remove the 3 screws (1) and separate the center display (2) and the bracket A (3).

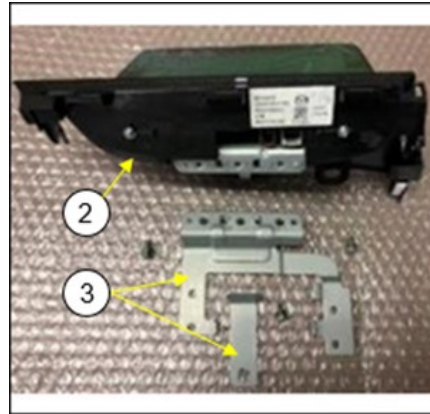
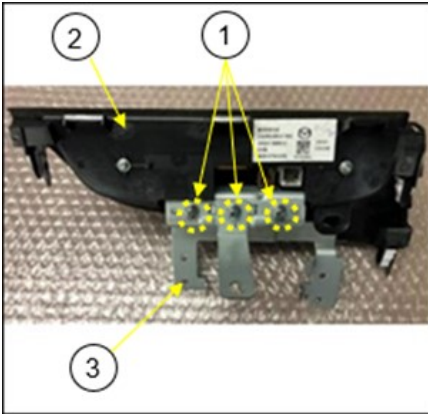

NOTE: After screwing together the center display (2) and the bracket A (3), check that the screws (1) are seated properly, and then retighten them. (Screw: M5 x 10 mm with a washer)

7. Remove the 4 screws (1) on the backside and the bottom of the center display, and then remove the panel (2) from the center display (3).

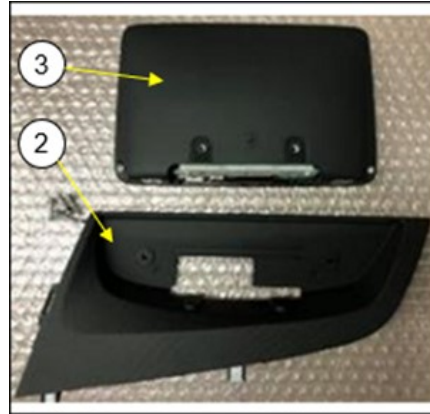
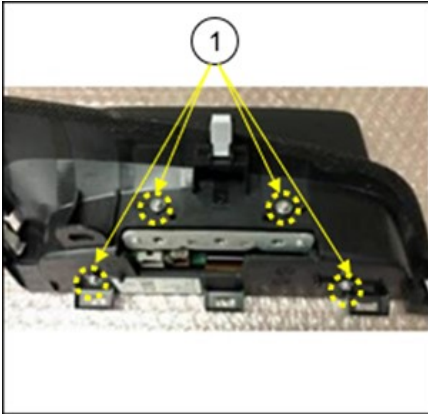

NOTE: After screwing together the center display (3) and the panel (2), check that the screws (1) are seated properly, and then retighten them. (Screw: M3 x 16 mm with a washer)

CONSUMER NOTICE: The information and instructions in this bulletin are intended for use by skilled technicians. Mazda technicians utilize the proper tools/ equipment and take training to correctly and safely maintain Mazda vehicles. These instructions should not be performed by "do-it-yourselfers." Customers should not assume this bulletin applies to their vehicle or that their vehicle will develop the described concern. To determine if the information applies, customers should contact their nearest authorized Mazda dealership. Mazda North American Operations reserves the right to alter the specifications and contents of this bulletin without obligation or advance notice. All rights reserved. No part of this bulletin may be reproduced in any form or by any means, electronic or mechanical---including photocopying and recording and the use of any kind of information storage and retrieval system ---without permission in writing.

8. Remove the 2 screws (1) on backside of the center display (2), then unhook (3) and remove the rear cover (4) from the center display (2).

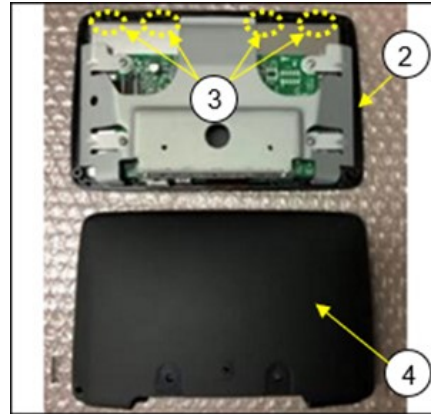
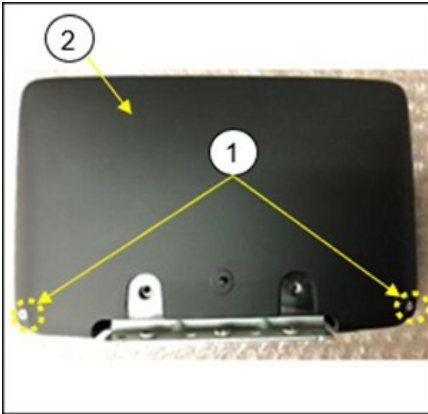

NOTE:

- When installing the rear cover (4) to the center display (2), apply the 4 snap-fits (3) properly.
- After screwing the center display (2) and the rear cover (4), check that the screws (1) are seated properly, then retighten them. (Screw: M3 x 15 mm with a washer)

9. Remove the 4 screws (1) that attach the center display (2) and the bracket B (3).

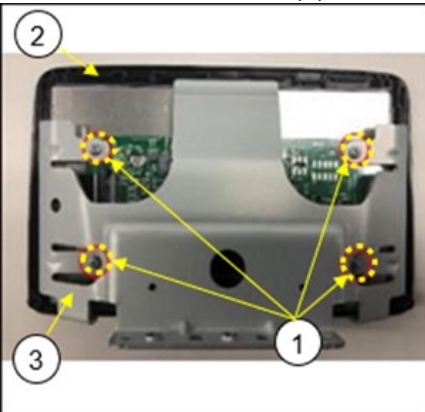

NOTE: After screwing together the bracket B (3) and the center display (2), check that the screws (1) are seated properly. (Screw: M3 x 9 mm)

CONSUMER NOTICE: The information and instructions in this bulletin are intended for use by skilled technicians. Mazda technicians utilize the proper tools/ equipment and take training to correctly and safely maintain Mazda vehicles. These instructions should not be performed by "do-it-yourselfers." Customers should not assume this bulletin applies to their vehicle or that their vehicle will develop the described concern. To determine if the information applies, customers should contact their nearest authorized Mazda dealership. Mazda North American Operations reserves the right to alter the specifications and contents of this bulletin without obligation or advance notice. All rights reserved. No part of this bulletin may be reproduced in any form or by any means, electronic or mechanical---including photocopying and recording and the use of any kind of information storage and retrieval system ---without permission in writing.

10. Remove the bracket B (1) from the center display (2).

NOTE: There are 2 snap-fits (3) on the left and right side of the center display.

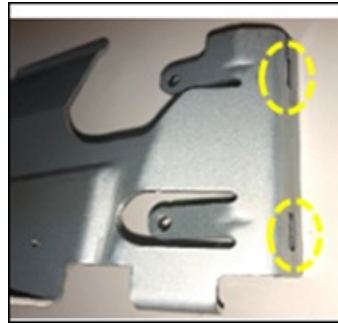
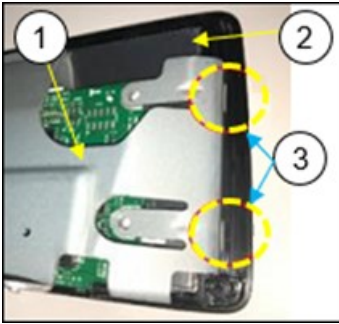

Assembly of the center display and the bracket B

Holes of the bracket B

Hooks on the center display

11. Insert a tip of a flathead screwdriver in underside the gap (2), and then remove the bracket B (1) partially.

NOTE: When inserting the screwdriver, DO NOT damage the circuit board.

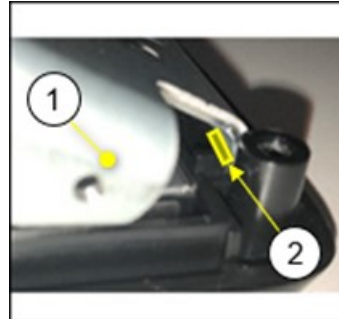
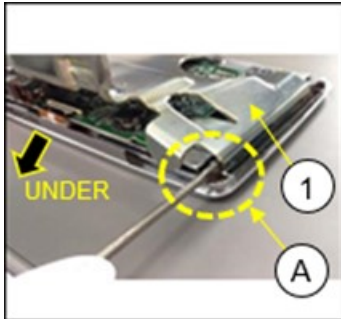

DETAIL A

Insert a flathead screwdriver.

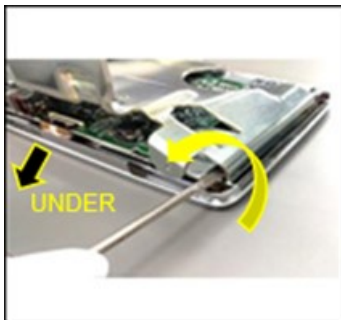

CONSUMER NOTICE: The information and instructions in this bulletin are intended for use by skilled technicians. Mazda technicians utilize the proper tools/ equipment and take training to correctly and safely maintain Mazda vehicles. These instructions should not be performed by "do-it-yourselfers." Customers should not assume this bulletin applies to their vehicle or that their vehicle will develop the described concern. To determine if the information applies, customers should contact their nearest authorized Mazda dealership. Mazda North American Operations reserves the right to alter the specifications and contents of this bulletin without obligation or advance notice. All rights reserved. No part of this bulletin may be reproduced in any form or by any means, electronic or mechanical---including photocopying and recording and the use of any kind of information storage and retrieval system ---without permission in writing.

12. Insert a tip of a flathead screwdriver in upper side of the gap (1), then remove the bracket B.

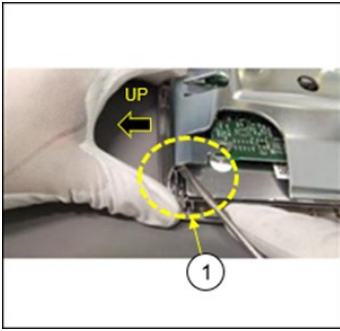

Bracket B



Center display

13. Pull up the lock tab (1) to unlock the connector.

NOTE: Pull the lock tab (1) gently to avoid the lock tab (1) from being damaged.

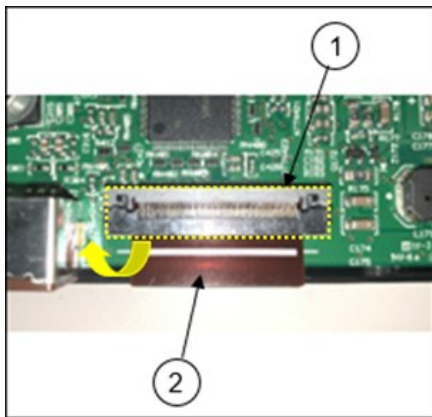
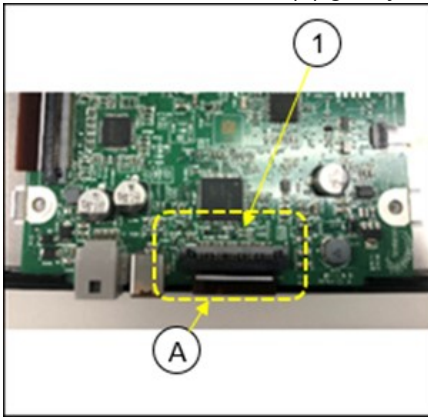

Lock:



DETAIL A
(1) Lock tab (2) Cable

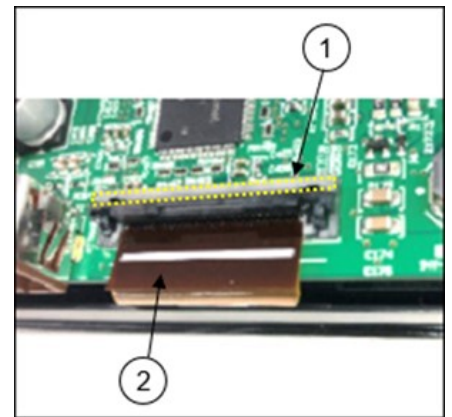

Unlock

CONSUMER NOTICE: The information and instructions in this bulletin are intended for use by skilled technicians. Mazda technicians utilize the proper tools/ equipment and take training to correctly and safely maintain Mazda vehicles. These instructions should not be performed by "do-it-yourselfers." Customers should not assume this bulletin applies to their vehicle or that their vehicle will develop the described concern. To determine if the information applies, customers should contact their nearest authorized Mazda dealership. Mazda North American Operations reserves the right to alter the specifications and contents of this bulletin without obligation or advance notice. All rights reserved. No part of this bulletin may be reproduced in any form or by any means, electronic or mechanical--including photocopying and recording and the use of any kind of information storage and retrieval system ---without permission in writing.

NOTE: After locking the lock tab (1), check that the line of the cable (2) and the line of the circuit board (3) are aligned.

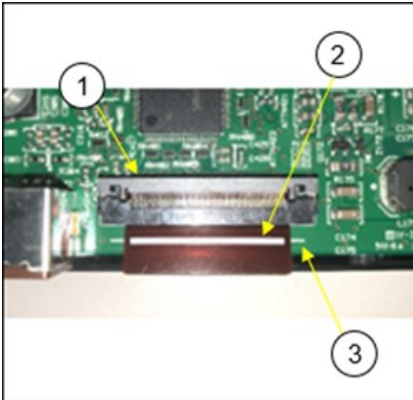

14. Hold both edges of the cable, then pull it out.

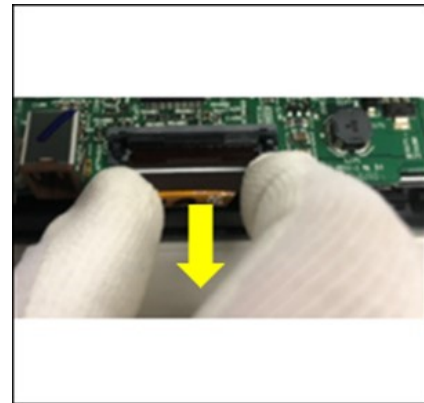
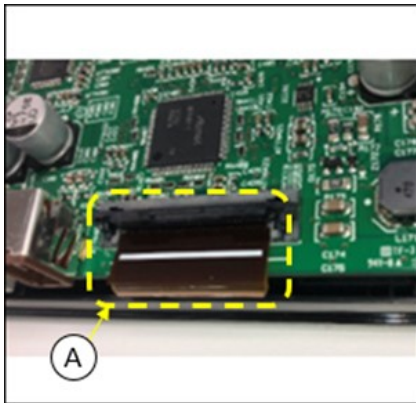

DETAIL A

NOTE: Hold both edges of the cable and insert the cable carefully so that the cable will not be damaged.

15. Remove the center display from the lens.

16. Replace the lens with a modified one, but reuse the center display

NOTE:

- When installing the center display to the modified lens, clear foreign objects and contamination on the lens and the center display.
- When installing the center display to the modified lens, check that a gasket has been installed to the lens properly.

CONSUMER NOTICE: The information and instructions in this bulletin are intended for use by skilled technicians. Mazda technicians utilize the proper tools/ equipment and take training to correctly and safely maintain Mazda vehicles. These instructions should not be performed by "do-it-yourselfers." Customers should not assume this bulletin applies to their vehicle or that their vehicle will develop the described concern. To determine if the information applies, customers should contact their nearest authorized Mazda dealership. Mazda North American Operations reserves the right to alter the specifications and contents of this bulletin without obligation or advance notice. All rights reserved. No part of this bulletin may be reproduced in any form or by any means, electronic or mechanical---including photocopying and recording and the use of any kind of information storage and retrieval system ---without permission in writing.



Replace: Lens



Reuse: Center display

17. Assemble the center display in the reverse order of disassemble.

NOTE:

- Hold both edges of the cable and insert it carefully so that the cable will not be damaged.
- After locking the lock tab, check that the line of the circuit board and the line of the cable are aligned.
- After screwing together the bracket B and the center display, check that the screws are seated properly. [Screw: M3 x 9 mm, 4 pcs.]
- When installing the rear cover to the center display, apply the 4 snap-fits properly.
- After screwing together the center display and the rear cover, check that the screws are seated properly, and then retighten them. [Screw: M3 x 15 mm with a washer, 2 pcs.]
- After screwing together the center display and panel, check that the screws are seated properly, and then retighten them. [Screw: M3 x 16 mm with washer, 2 pcs.]
- After screwing together the center display and the bracket A, check that the screws are seated properly, and then retighten them. [Screw: M5 x 10 mm with a washer, 3 pcs.]

18. Install the center display in the reverse order of removal.

19. Verify the repair.

CONSUMER NOTICE: The information and instructions in this bulletin are intended for use by skilled technicians. Mazda technicians utilize the proper tools/ equipment and take training to correctly and safely maintain Mazda vehicles. These instructions should not be performed by "do-it-yourselfers." Customers should not assume this bulletin applies to their vehicle or that their vehicle will develop the described concern. To determine if the information applies, customers should contact their nearest authorized Mazda dealership. Mazda North American Operations reserves the right to alter the specifications and contents of this bulletin without obligation or advance notice. All rights reserved. No part of this bulletin may be reproduced in any form or by any means, electronic or mechanical---including photocopying and recording and the use of any kind of information storage and retrieval system ---without permission in writing.

PARTS INFORMATION

Parts Number	Description	Qty.	Notes
D0YP-61-1JZ	Center Display Lens Kit	1	Kit repairs D09H-61-1J0B or older (for 2016-2017 Mazda2 and CX-3)
D2YN-61-1JZA			Kit repairs D23N-61-1J0B only (for 2019-2022 Mazda2 and CX-3)
D0YP-61-1JZ			Kit repairs NA1P-61-1J0B or older (for 2016-2017 MX-5)
D1YP-61-1JZ			Kit repairs ND1F-61-1J0A or older (for 2020-2022 MX-5)
D2YN-61-1JZA			Kit repairs ND1F-61-1J0B/C only (for 2020-2022 MX-5)

NOTE:

- Refer to EPC to select the applicable display assembly part number.
- D23N-61-1J0C is the modified part.

WARRANTY INFORMATION**NOTE:**

- This warranty information applies only to verified customer complaints on vehicles eligible for warranty repair.
- This repair will be covered under Mazda's New Vehicle Limited Warranty term.
- Additional diagnostic time cannot be claimed for this repair.

Warranty Type	A
Symptom Code	61
Damage Code	9W
Part Number Main Cause	****-61-1JZ*
Quantity	1
Operation Number / Labor Hours:	XXW4WBRX / 0.5 Hrs. (CX-3, Mazda2) XXW4WCRX / 0.6 Hrs. (MX-5)

CONSUMER NOTICE: The information and instructions in this bulletin are intended for use by skilled technicians. Mazda technicians utilize the proper tools/ equipment and take training to correctly and safely maintain Mazda vehicles. These instructions should not be performed by "do-it-yourselfers." Customers should not assume this bulletin applies to their vehicle or that their vehicle will develop the described concern. To determine if the information applies, customers should contact their nearest authorized Mazda dealership. Mazda North American Operations reserves the right to alter the specifications and contents of this bulletin without obligation or advance notice. All rights reserved. No part of this bulletin may be reproduced in any form or by any means, electronic or mechanical---including photocopying and recording and the use of any kind of information storage and retrieval system ---without permission in writing.