

ATTENTION:

GENERAL MANAGER
 PARTS MANAGER
 CLAIMS PERSONNEL
 SERVICE MANAGER

IMPORTANT - All
 Service Personnel
 Should Read and
 Initial in the boxes
 provided, right.



QUALITY DRIVEN® SERVICE

PRODUCT CAMPAIGN BULLETIN

APPLICABILITY: 2003-2004 Subaru Legacy and Outback
 2003-2004 Subaru Baja
 2004 Subaru Impreza (including WRX and STI)

NUMBER: WQL-48R
DATE: August 2014
REVISED: August 25, 2014
NHTSA ID: 14V-399

SUBJECT: Front Passenger Air Bag Inflator Replacement

Subaru of America, Inc. (SOA) has determined that a defect, which relates to motor vehicle safety, may exist on certain 2003-2004 model year Subaru Legacy, Outback, and Baja vehicles, and certain 2004 model year Subaru Impreza (including WRX and STI) vehicles.

The subject vehicles are equipped with front passenger air bag inflators which could have been assembled with improperly manufactured propellant wafers. In the event of a crash necessitating deployment of the passenger side frontal air bag, improperly manufactured propellant wafers inside the inflator could cause the inflator to rupture with metal fragments striking and potentially seriously injuring the vehicle occupants.

Although the percentage of affected vehicles is unknown, this recall will involve replacing the front passenger air bag inflator on all of the potentially affected vehicles.

AFFECTED VEHICLES

This condition may exist on certain 2003-2004 model year Legacy, Outback, and Baja vehicles, and certain 2004 model year Impreza, WRX, and STI vehicles listed below.

Not all vehicles within these production date ranges are affected by this recall. The potentially affected vehicles were identified based on the serial number of the front passenger air bag inflator installed during vehicle production.

Coverage for all potentially affected vehicles must be confirmed by using the Vehicle Coverage Inquiry function on subarunet.com. This data will be available when owner notification begins.

MODEL YEAR	MODEL	STARTING PRODUCTION DATE	ENDING PRODUCTION DATE
2003	Legacy	01/22/2003	05/14/2003
2004	Legacy	03/17/2003	02/10/2004
2003	Outback	02/18/2003	04/15/2003
2004	Outback	02/28/2003	02/11/2004
2003	Baja	01/22/2003	05/06/2003
2004	Baja	03/03/2003	07/21/2004
2004	Impreza, WRX, STI	01/08/2003	05/15/2003

Continued...

OWNER NOTIFICATION

Notification letters will be sent to owners of all potentially affected vehicles. Owner notification is currently scheduled to begin on August 11, 2014. A copy of the Owner Notification Letter is included at the end of this bulletin.

RETAILER AFFECTED VIN LISTS

Each Subaru retailer will receive an affected VIN list from their Zone Office when owner notification begins. Vehicles will be assigned to retailers in the affected VIN list as follows:

- Original vehicle owners are assigned to the original selling retailer when their current address is within a 100 mile radius of that retailer.
- If the original selling retailer is inactive, the VIN has been assigned to the nearest active retailer.
- For any new owners or when original owners live more than 100 miles from the original selling retailer, the VIN has been assigned to the nearest active retailer.

Important: Retailer affected VIN lists include owner name and address information for vehicles affected by this recall. This information will enable retailers to follow-up with owners of potentially affected vehicles. The lists contain owners' names and addresses obtained from State Motor Vehicle Registration Records. The use of such motor vehicle registration data for any other purpose is unlawful. Accordingly, retailers are urged to limit the use of these lists for the purpose of completion of this safety recall.

SUBARU RETAILER PROGRAM RESPONSIBILITY

Retailers are to promptly perform the applicable service procedures to correct all affected vehicles in their inventory (new, used, demo & SSLP). Additionally, whenever a vehicle subject to this recall is taken into retailer new or used inventory, or in for service, necessary steps should be taken to ensure the recall correction has been made before selling or releasing the vehicle.

New, used, demo or SSLP (Subaru Service Loaner Program) vehicles listed in a recall/campaign that are in the retailer's stock must be:

- Immediately identified.
- Tagged or otherwise marked to prevent their delivery or use prior to inspection and/or repair.
- Repaired in accordance with the repair procedures outlined in this Product Campaign Bulletin.

Continued...

PARTS INFORMATION

The parts required for this recall are the passenger air bag inflator module kits listed below:

PART NUMBER	APPLICABILITY	DESCRIPTION	ORDER QUANTITY
98279AE00A	Legacy, Outback, and Baja	WQL-48 Air Bag Inflator Module Kit	1
98279FE000	Impreza, WRX, and STI	WQL-48 Air Bag Inflator Module Kit	1

These parts are available through normal parts ordering channels. In order to maintain an adequate part supply, SOA requests that retailers only order quantities necessary to satisfy anticipated demand.

PART RETURN PROCEDURES

IMPORTANT:

Each removed air bag inflator must be returned directly to the supplier, Takata USA, in the same box in which the new one was received.

As the shipper, you are responsible for proper packing and document completion. The person packaging the inflator must have received hazardous material training per 49CFR 172.702, and the training records must be on file at your dealership. The US Department of Transportation will impose substantial fines and/or penalties on the shipper if either packaging, labeling or documentation is not properly prepared and the Customer Copy of OP 900PRP form is not kept on file for a minimum of 2 years.

IMPORTANT: Do not deploy any inflator. Return the used inflator within 1-2 business days. The person packing the used inflator must read and follow the provided instructions.

- The shipping box contains a bar code with the serial number of the new air bag inflator, which will be used by Takata USA to document the replacement of the old inflator with the new inflator. **Therefore, it is very important that the removed inflator be returned in the exact same box that contained the newly-installed inflator for that vehicle.** If the original box cannot be re-used, please refer to the shipping instructions under “Requesting a new box/shipping labels.”
- Prepaid FedEx shipping documents and shipping instructions will be included with each new air bag inflator kit. A copy of this information is included as ‘Appendix A’ of this bulletin.
- A completed SOA Warranty Parts Tag (MSA5W402A) must be attached to the returned inflator. The tag must contain the following information: claim number, repair date, full 17-digit VIN, and mileage.
- Takata USA has assigned each Subaru retailer a **ChemTrec Contract Number (CCN)**. As shown in step 5 of the shipping documentation instructions, the shipping retailer must fill in their name, address, and CCN.
 - o ChemTrec is a company that provides 24-hour emergency response and information to hazardous material shippers.
 - o The assigned CCN allows the Subaru retailer to ship hazardous material as an affiliate to Takata USA’s registration with ChemTrec. This number is required on the return shipping form.

Continued...

A list of all Subaru retailers along with their assigned CCN information is included as 'Appendix B' of this bulletin. It is SOA's intention to include a copy of this list with each new air bag inflator kit, however the first shipment of parts will not include this list as it was not available at the time the parts were packed. Future shipments will include this document for reference.

The CCN list included with future shipments will be updated periodically to include new Subaru retailer information. If a Subaru retailer is unable to find their CCN, they should contact Takata USA as described in step 5 of the shipping documentation instructions.

SOA PART RETURN NOTICE

Upon claim approval, Subaru of America, Inc. will generate a Part Return Notice requesting information only. To ensure proper claim credit, the following information must be recorded on the SOA Part Return Notice and sent to SOA Part Collection Center (PCC) as instructed on the return notice:

- The FedEx Shipper Receipt # (from shipping form)
- The OLD and NEW air bag inflator serial numbers

The Part Return Notice should then be returned using UPS 3rd party billing to the address listed at the bottom of the notice. Please keep the UPS tracking number for your records. Under no circumstances should the air bag inflator be returned to Subaru of America, Inc.

SERVICE PROCEDURE

This Campaign involves the replacement of the inflator portion of the passenger-side front airbag assembly. The subject inflators could have been assembled with improperly manufactured propellant components which may affect how the assembly inflates in the event of a collision resulting in an increased risk of injury to vehicle occupants. This procedure will outline removal of the passenger-side airbag assembly and replacement of the inflator component and related wiring harness.

VERY IMPORTANT: Failure to follow these service procedures carefully and correctly may result in an accidental deployment of the inflator and potentially cause serious injury. Please read through and understand these procedures COMPLETELY before beginning repairs. In addition, proper operation of the airbag after reassembly may be compromised if these service procedures are not followed.

Continued...

Tools Required

DESCRIPTION	BRAND OR TYPE	QUANTITY
Pliers	-	1
Wire Cutters	-	1
Needle-Nose Pliers	-	1
Torque Wrench	Inch-Pound	1
Safety Goggles	-	1
Flat-Blade Screwdriver	-	1
Scissors	-	1
Ratchet	1/4" Drive	1
8 mm Socket		1

NOTE: Although the service procedure is similar for both Legacy / Outback / Baja and Impreza models, there are some significant differences. For this reason, procedures for both models will be outlined.

CAUTION: Before starting this service procedure, perform a visual inspection of both front airbags looking for any damage or abnormality. Next, turn the ignition switch to the “ON” position and confirm the airbag warning lamp illuminates then extinguishes normally. If it does not or if **ANY** concern is noted with the airbag system, **STOP** and report these findings to the customer **BEFORE** proceeding further. Any concerns identified with the airbag system (when no airbag deployment has occurred), are not related to this campaign and must be addressed separately. Even if the system has a concern, this may not preclude completion of this campaign. If you are unsure about proceeding, document and fully diagnose the concern then contact the SOA Technical Helpline to review your findings. It is in the best interest of the retailer to fully document any concerns found during this preliminary inspection and review with the customer **BEFORE** proceeding with the campaign service procedure.

SERVICE PROCEDURE FOR LEGACY / OUTBACK AND BAJA MODELS

CAUTION: Refer to the “CAUTION” section in the General Description portion of Airbag System AB in the Body Section of the Service Manual before handling or servicing any airbag module!

STEP 1- PREPARATION:

- Turn the ignition “OFF”.
- Disconnect the Negative (ground) cable from the battery and wait **at least 20 seconds** before proceeding further.
- Remove the glove box assembly following the procedure in the applicable Service Manual and using the tips below.

The glove box is held in place by 8 screws.

- o The 2 upper left and right hand corner screws have a distinctive gold finish and 10mm hex head. It is helpful to leave these 2 screws until last when removing and install first during replacement to support the weight of the assembly.
- o It is necessary to remove the knockout plugs (stopper in the Service Manual) to gain access to all the mounting screws.
- o It is possible to leave the stoppers in place during servicing by carefully bending in the sides of the glove box until the stoppers are cleared.
- To prevent damage, do not bend them in any further than necessary.

Continued...

IMPORTANT: Whenever beginning to remove (or install) the airbag assembly, and periodically while performing the procedure or after stepping away, remove any possible static charge from your body by momentarily touching a clean, bare metal ground point on the vehicle (e.g. the door striker). Remove from your person all electronic devices including cell phones before proceeding.

- Disconnect the airbag module harness connector (A) and release it from the support beam bracket.

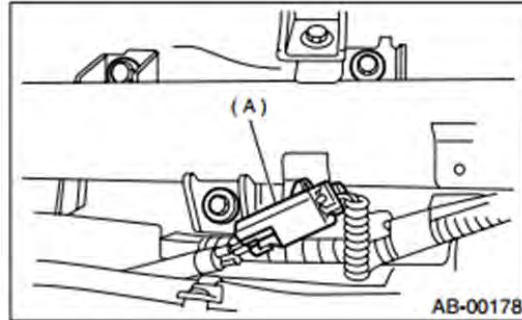

- Remove the 3 retaining bolts and **CAREFULLY** remove the airbag module from the vehicle and place it on a clean cloth to protect the dash trim outer surface portion from damage.

IMPORTANT: DO NOT destroy or damage the Kit Box as it **MUST** be used for the original inflator's return shipping.

- Open the Kit Box and confirm all the necessary components are included:
 - 4 Self-Locking nuts
 - New Inflator (yellow tape applied to one end to identify it as the replacement part)
 - New Inflator Harness
 - Electro-Tap (red shorting crimp connector)
 - Shipping Declaration document, FedEx document pouch and return shipping label



Continued...

- Throughout the inflator replacement procedure, keep the airbag assembly in a position perpendicular to the edge of the work table as shown in the photo below. With the airbag assembly in this position, should a deployment occur, risk of injury would be reduced as force would be directed toward the side, not directly toward the Technician. Always perform this work in an area away from others to reduce chances of inadvertent injury should any deployment occur. Take your surroundings into account to avoid possible hazards should inadvertent deployment occur or sources of static or other electricity that could potentially induce such a deployment.

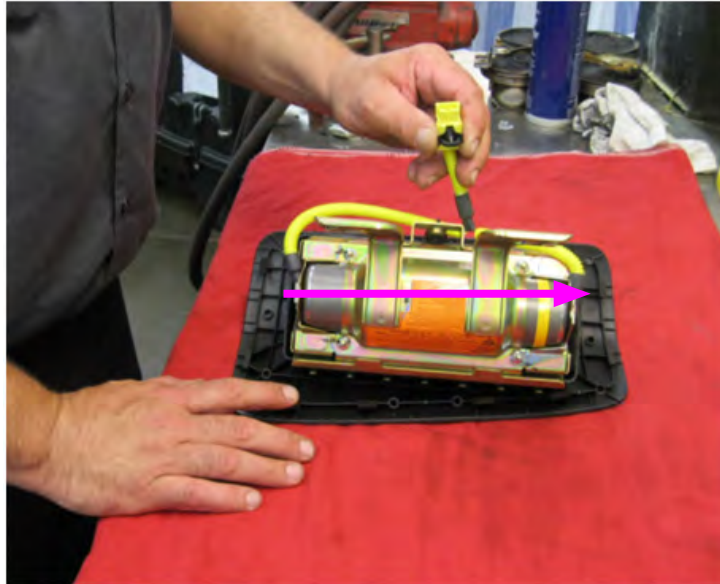

STEP 2- Remove the harness clip from the retainer bracket by rotating the harness / clip 90 degrees then releasing it from the bracket with needle-nose pliers.

STEP 3- CAREFULLY cut the yellow harness cover (approximately 1 1/2 inches) enough to expose the 2 yellow wires inside and provide enough room to install the Electro-Tap (shorting) connector using a scissor or wire cutter (no knives or razors). **TAKE YOUR TIME AND BE CAREFUL TO NOT CUT THE 2 YELLOW WIRES!**



Continued...

STEP 4- Short the 2 yellow wires together by installing the Electro-Tap connector. The connector creates a short circuit which acts as a safeguard to prevent against static discharge that may deploy the removed inflator. The tab portion of the Electro-Tap connector **MUST** be cut off prior to use to insure a good short-circuit is made as shown in the illustration below. **Follow the sequence below** for installing the Electro-Tap connector. Use pliers to squeeze closed the two sections of the connector together, **one section at a time**.

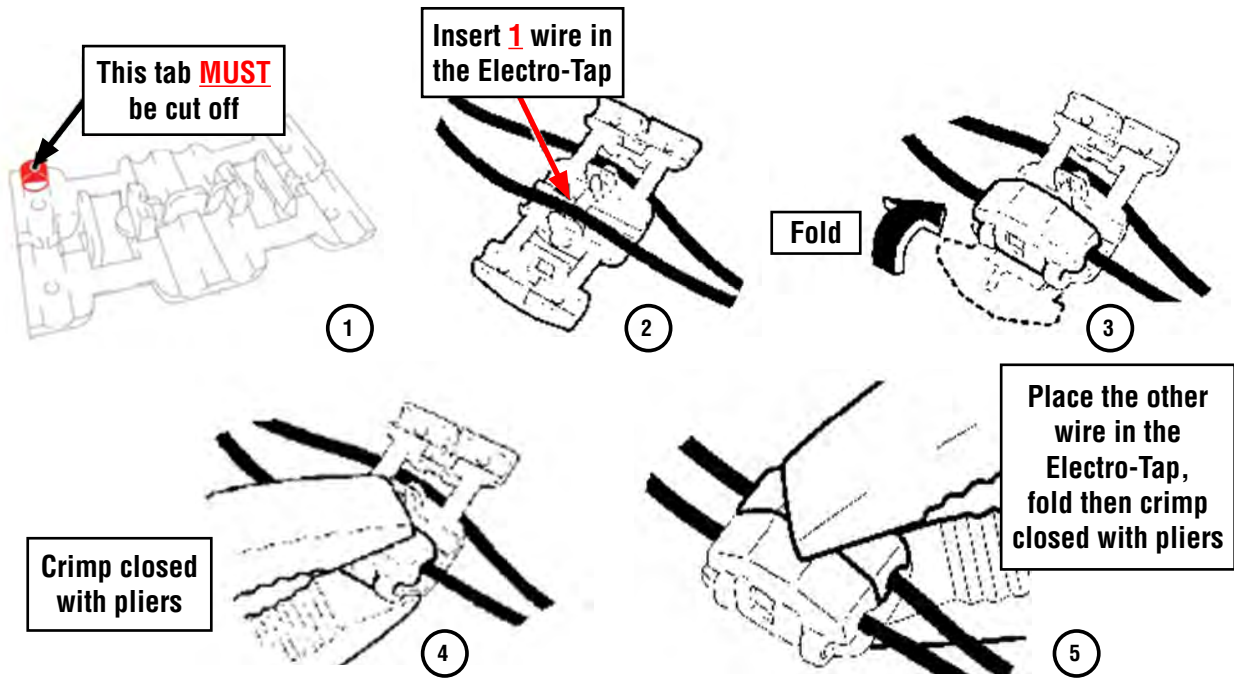

STEP 5- Once the Electro-Tap connector is fully crimped in place, cut the 2 yellow wires on the **body harness connector side** of the Electro-Tap connector.

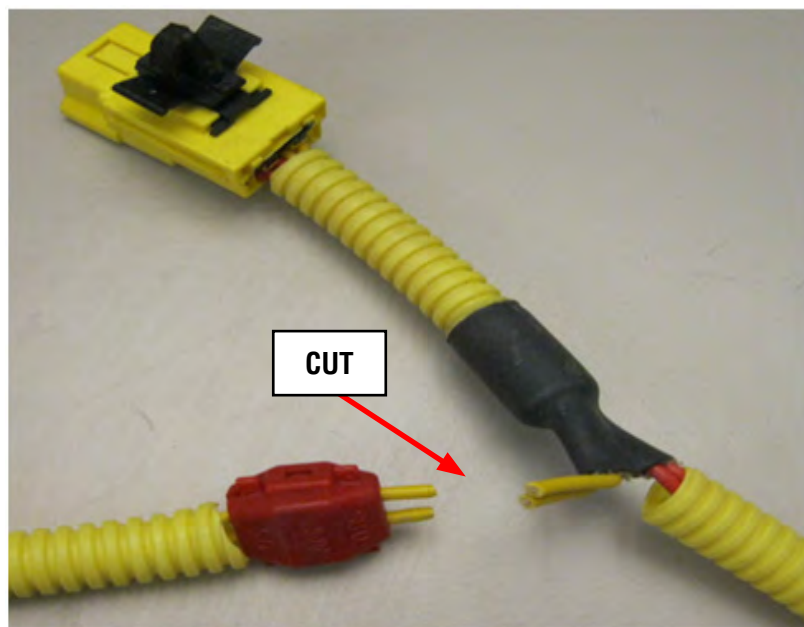

Continued...

STEP 6- Remove the two 8mm self-locking nuts securing the stopper plate. Loosen but **do not remove** the other two nuts on the mounting bracket as leaving them in place will help keep the airbag assembly together.

NEVER ATTEMPT TO REMOVE THE HARNESS CONNECTORS FROM THE INFLATOR!

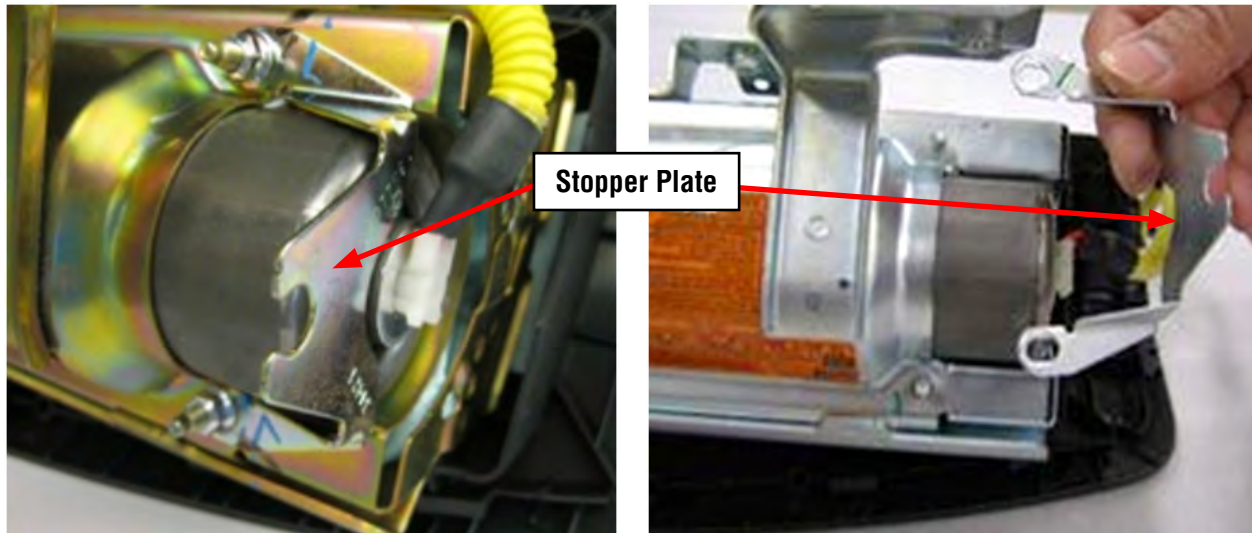

STEP 7- Slide the original inflator out of the mounting bracket while feeding the cut off portion of the wiring harness through the “D-Shaped” hole in the end plate. **NEVER ATTEMPT TO REMOVE THE HARNESS CONNECTORS FROM THE INFLATOR!** Place the removed original air bag inflator in the “cradle” of the Kit Box insert.

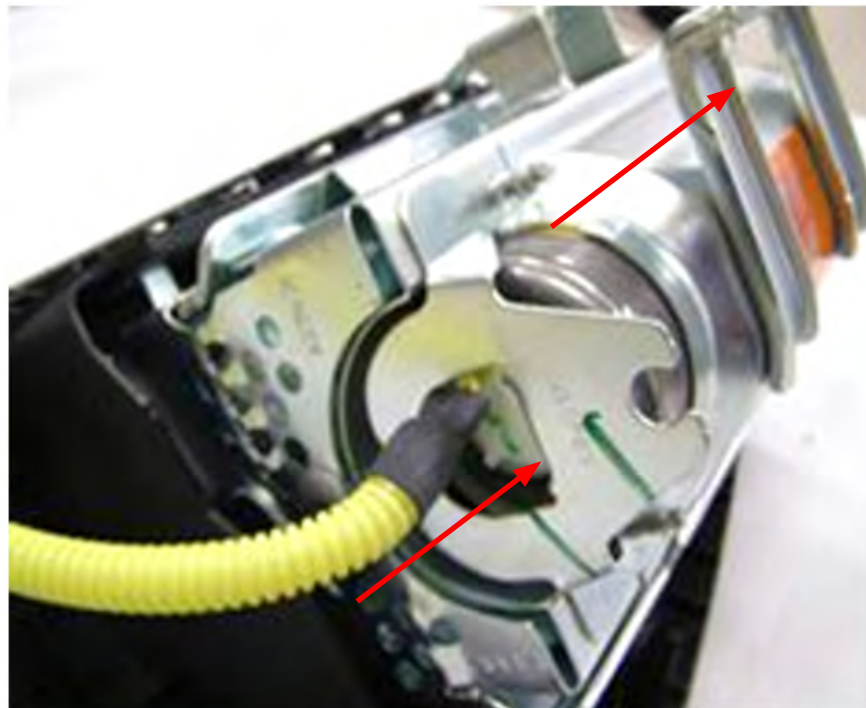

Continued...

STEP 8- VERY IMPORTANT: Record the **FedEx Shipper Receipt Number** (located at the top of the return shipping label included with the new inflator) and the **11-digit alphanumeric serial number for both the new and the removed inflators** on the hard copy of the Repair Order. This information will be required for completion of the Part Return Notice which will be forwarded by the retailer to the PCC.

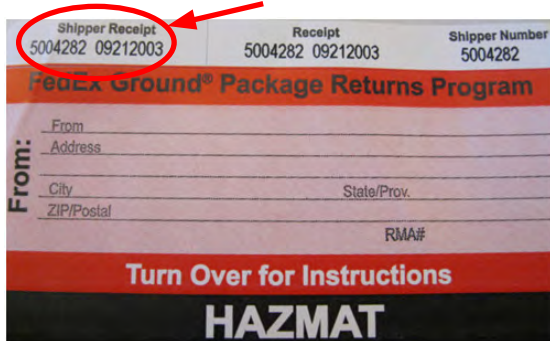

STEP 9- Install the new inflator into the mounting bracket so the yellow taped end aligns with the removed stopper plate. Make sure the “D-shaped” portion of the inflator harness connector boss aligns with the “D-shaped” portion of the hole in the end of the mounting bracket as shown below. When properly installed, the end of the inflator will be seated tight against the mounting bracket. Do not peel the white connection dust cover at this time.



Inflator properly seated against mounting bracket (NO GAP)

STEP 10- Reinstall the stopper plate using 2 of the **NEW** self-locking nuts but do not tighten them fully. Remove the nuts still installed on the mounting bracket and replace them with 2 **NEW** self-locking nuts. Once all 4 **NEW** nuts are in place, **torque to 31 - 38 inch pounds in the sequence shown below**. Use a marker to mark the nuts after torquing indicating they have been fully tightened.

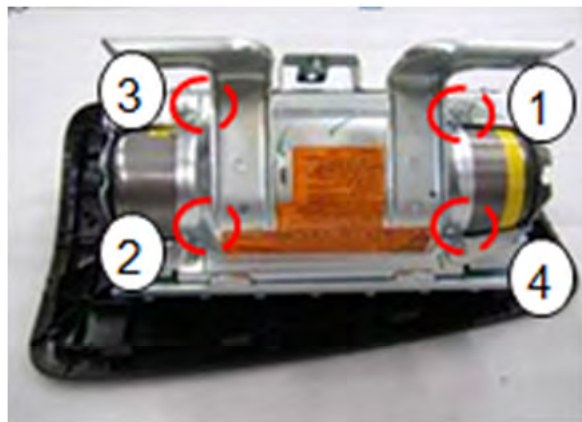

Continued...

STEP 11- The new inflator wiring harness has a “long side” and a “short side” with round 2-pin connectors on both ends. The short side with red wires will connect to the end of the inflator with the round wiring harness connector boss, yellow tape and removable stopper plate.



Peel off the white dust cover from the round connector boss end of the inflator **ONLY**. **CAREFULLY** align the pins with the female terminals of the harness connector (2 red wires) as shown in the sequence below. **IMPORTANT: NEVER PEEL BOTH THE WHITE DUST COVERS OFF AT THE SAME TIME!** Once pin alignment is confirmed, push down firmly to engage the connector’s 3 locking tangs into the locking groove inside the connector boss. Confirm the connector is locked by prying up **LIGHTLY** with a small flat-blade screwdriver. Repeat the procedure on the D-shaped connector boss end (2 yellow wires). Reinstall the black wiring harness retaining clip into the mounting bracket to complete the airbag reassembly.

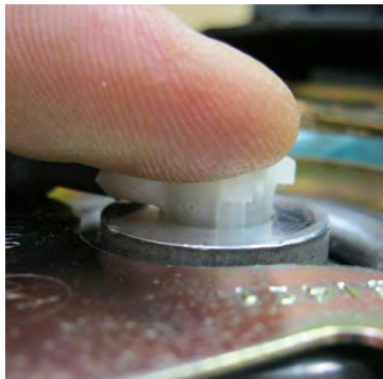
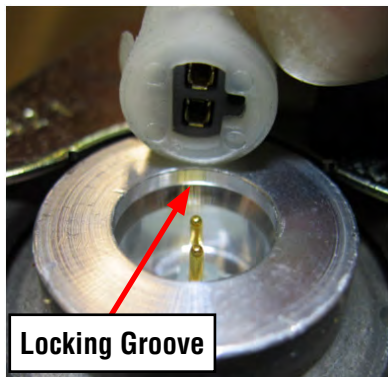

STEP 12- Reinstall the airbag assembly into the vehicle in reverse order of disassembly. Before installing the glove box assembly, reconnect the negative battery cable. Turn the ignition key “ON” and confirm the AIRBAG warning light comes on then cycles off properly. Once proper warning light operation is confirmed, reinstall the glove box assembly to complete the procedure.

STEP 13- Place the removed original air bag inflator in the “cradle” of the Kit Box insert, with a completed SOA warranty parts tag (MSA5W402A) attached to it. The tag must contain the following information: **Claim Number, Repair Date, 17-digit VIN, and vehicle mileage.** Refer to the “PARTS RETURN PROCEDURES” section of this bulletin (page 3) for further return shipping instructions and information. **Ensure both the removed and installed inflator serial numbers along with the FedEx Shipper Receipt number have been recorded correctly as previously instructed on the repair order hard copy before returning the removed part to your Parts Department.**

IMPORTANT: UNDER NO CIRCUMSTANCES SHOULD ANY AIR BAG INFLATORS BE RETURNED TO SUBARU OF AMERICA, INC.

Continued...

Refer to Page 18 for instructions on completing and installing the Recall Identification Label.

SERVICE PROCEDURE FOR IMPREZA, WRX and STI MODELS

CAUTION: Refer to the “CAUTION” section in the General Description portion of Airbag System AB in the Body Section of the Service Manual before handling or servicing the airbag module!

STEP 1- PREPARATION:

- Turn the ignition “OFF”.
- Disconnect the Negative (ground) cable from the battery and wait **at least 20 seconds** before proceeding further.
- Remove the glove box assembly following the procedure in the applicable Service Manual.

IMPORTANT: Whenever beginning to remove (or install) the airbag assembly, and periodically while performing the procedure or after stepping away, remove any possible static charge from your body by momentarily touching a clean, bare metal ground point on the vehicle (e.g. the door striker). Remove from your person all electronic devices including cellphones before proceeding.

- Disconnect the airbag module harness connector from the support beam bracket.
- Remove the 3 retaining bolts and **CAREFULLY** remove the airbag module from the vehicle and place it on a clean cloth to protect the dash trim surface portion from damage.

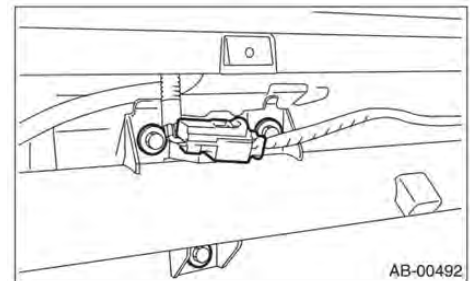

NOTE: There may be a Security Module secured with the lower airbag module mounting bolt on some models.

IMPORTANT: DO NOT destroy or damage the kit box as it **MUST** be used for the original inflator’s return shipping.

- Open the Kit Box and confirm all the necessary components are included:
 - 4 Self-Locking nuts
 - New Inflator (yellow tape applied to one end to identify it as the replacement part)
 - New Inflator Harness
 - Electro-Tap (red shorting crimp connector)
 - 1 ½” X 2 ¼” piece of self-adhesive Sponge Tape
 - Shipping Declaration document, FedEx document pouch and return shipping label



Continued...

- Throughout the inflator replacement procedure, keep the airbag assembly in a position perpendicular to the edge of the work table as shown in the photo below. With the airbag assembly in this position, should a deployment occur, risk of injury would be reduced as force would be directed toward the side, not directly toward the Technician. Always perform this work in an area away from others to reduce chances of inadvertent injury should any deployment occur. Take your surroundings into account to avoid possible hazards should inadvertent deployment occur or sources of static or other electricity that could potentially induce such a deployment.

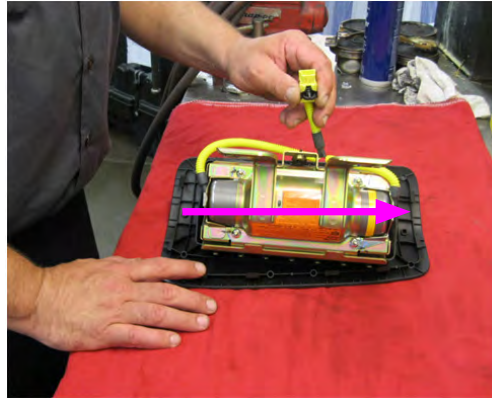

STEP 2- Peel the Sponge Tape and remove the harness clip from the retainer bracket by pushing the tangs inward with a flat-blade screwdriver as shown below. Always remove any Sponge Tape adhesive residue from the airbag mounting bracket using mild solvent on a clean shop cloth. **CAUTION:** Never use any silicone-based products for this purpose.

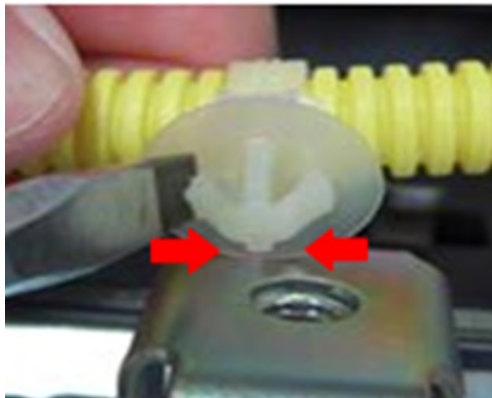

STEP 3- CAREFULLY cut the yellow harness cover enough (approximately 2 inches) to expose the 2 red or yellow wires inside and provide enough room to install the Electro-Tap (shorting) connector using a wire cutter or scissor (no knives or razors). **TAKE YOUR TIME AND BE CAREFUL TO NOT CUT THE 2 WIRES!**

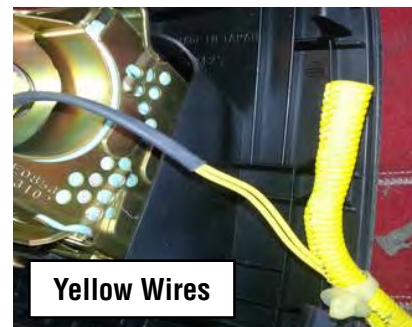
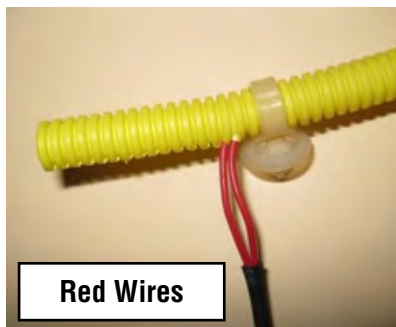

Continued...

STEP 4- Short the 2 wires together by installing the Electro-Tap connector. The connector creates a short circuit which acts as a safeguard to prevent against static discharge that may deploy the removed inflator. The tab portion of the Electro-Tap connector **MUST** be cut off prior to use to insure a good short-circuit is made as shown in the illustration below. **Follow the sequence** below for installing the Electro-Tap connector. Use pliers to squeeze closed the two sections of the connector together, **one section at a time**.

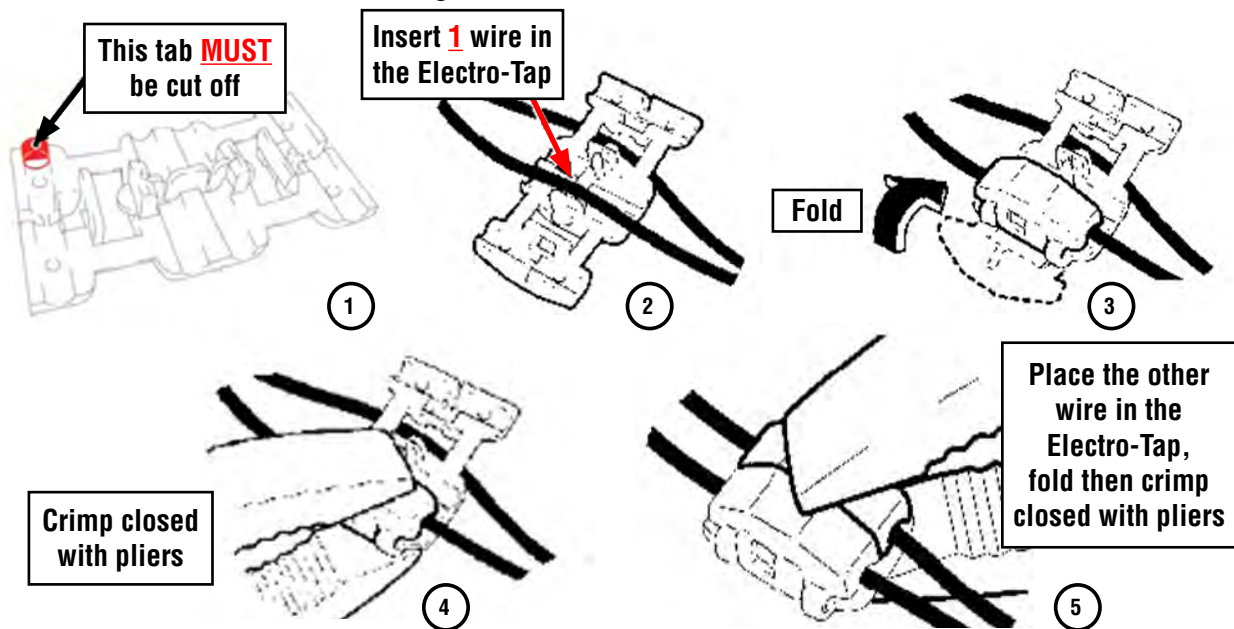

STEP 5- Once the Electro-Tap connector is fully crimped in place, cut the 2 wires on the **body harness connector side** of the Electro-Tap connector.

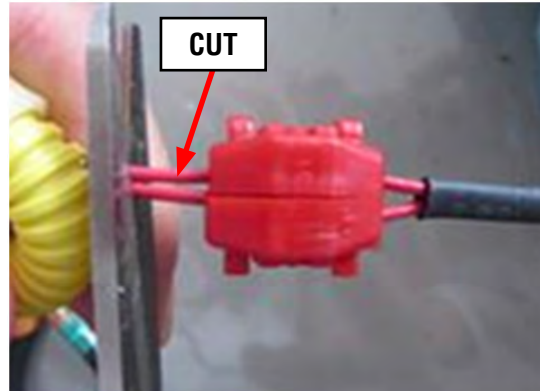

STEP 6- Remove the two 8mm self-locking nuts securing the stopper plate. Loosen but **do not remove** the other two nuts on the mounting bracket as leaving them in place will help keep the airbag assembly together.

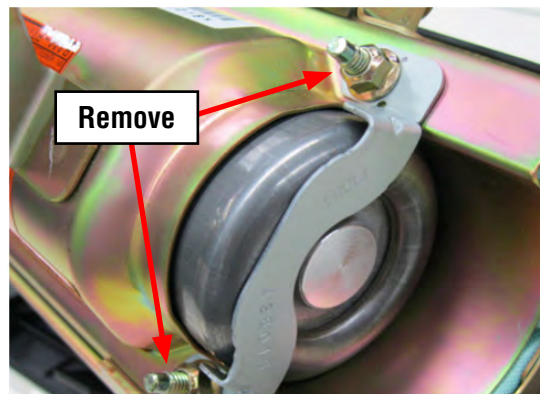

Continued...

STEP 7- Slide the inflator out of its mounting while feeding the cut off portion of the wiring harness through the “D-Shaped” hole in the end of the mounting bracket. **NEVER ATTEMPT TO REMOVE THE HARNESS FROM THE INFLATOR!** Place the removed original air bag inflator in the “cradle” of the Kit Box insert.



STEP 8- VERY IMPORTANT: Record the **FedEx Shipper Receipt Number** (located at the top of the return shipping label included with the new inflator) and the **11-digit alphanumeric serial number for both the new and the removed inflators** on the hard copy of the Repair Order. This information will be required for completion of the Part Return Notice which will be forwarded by the retailer to the PCC. The new serial number is also a requirement for claim entry.

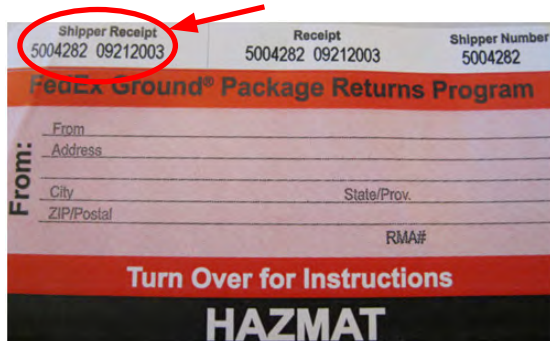

STEP 9- Install the new inflator into the mounting bracket with the harness connector end going in first toward the mounting bracket. Make sure the “D-shaped” portion of the inflator harness connector boss aligns with the “D-shaped” portion of the hole in the end of the mounting bracket as shown below. When properly installed, the end of the inflator will be seated tight against the mounting bracket. Do not peel the white connection dust cover at this time.



Inflator properly seated against mounting bracket (NO GAP)

Continued...

STEP 10- Reinstall the stopper plate using 2 of the **NEW** self-locking nuts but do not tighten them fully. Remove the nuts still installed on the mounting bracket and replace them with 2 **NEW** self-locking nuts. Once all 4 **NEW** nuts are in place, torque to 31 - 38 inch pounds in the sequence shown below. Use a marker to mark the nuts after torquing indicating they have been fully tightened.



STEP 11- The new inflator wiring harness (with 2 red wires inside) connects to the end of the inflator with the “D-shaped” connector boss. Peel off the white dust cover and **CAREFULLY** align the 2 inflator pins with the female terminals of the harness connector as shown in the sequence below. Once pin alignment is confirmed, push down firmly to engage the connector’s 2 locking tangs into the locking groove of the connector boss. Confirm the connector is fully locked by prying up **LIGHTLY** with a small flat-blade screwdriver.

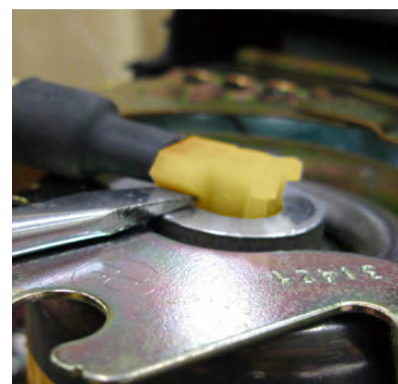
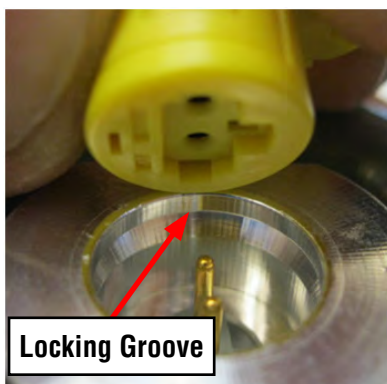

STEP 12- Reinstall the wiring harness retaining clip into its position on the mounting bracket.

Continued...

STEP 13- Peel the adhesive backing and install the new Sponge Tape onto the yellow harness tube first then adhere it to the airbag mounting bracket as shown in the illustrations below.

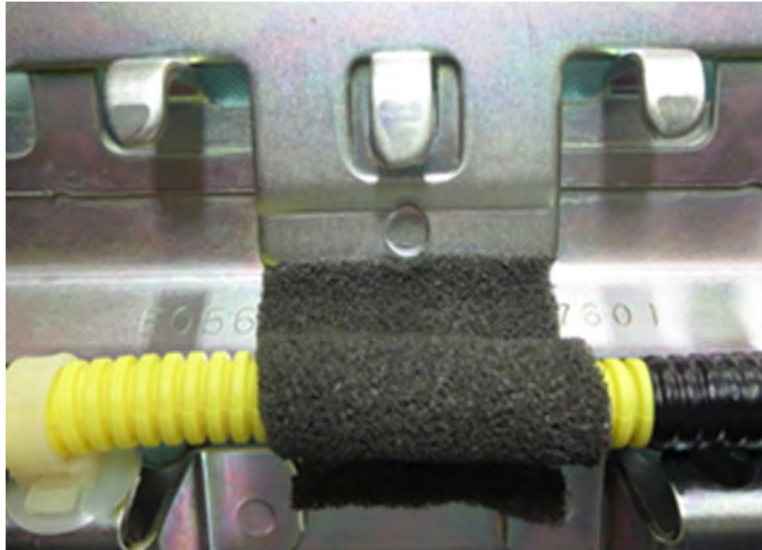

Placement of Sponge Tape

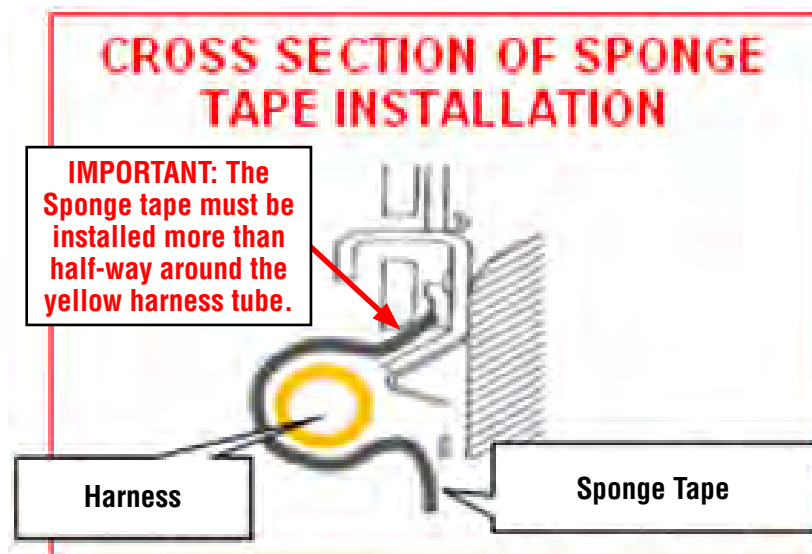

STEP 14- Reinstall the airbag assembly into the vehicle in reverse order of disassembly.
NOTE: If the accessory security module is installed to one of the airbag module mounting bolts, torque that specific bolt to 7.5 +/-1ft. lb. rather than the normal 5.4 ft. lb. specified in the Service Manual. Before installing the glove box assembly, reconnect the negative battery cable. Turn the ignition key “ON” and confirm the AIRBAG warning light comes on then cycles off properly. Once proper warning light operation is confirmed, reinstall the glove box assembly to complete the procedure.

STEP 15- Place the removed air bag inflator in the “cradle” of the Kit Box insert, with a completed SOA warranty parts tag (MSA5W402A) attached to it. The tag must contain the following information: **Claim Number, Repair Date, 17-digit VIN, and vehicle mileage.** Refer to the “PARTS RETURN PROCEDURES” section of this bulletin (page 3) for further return shipping instructions and information.

IMPORTANT: UNDER NO CIRCUMSTANCES SHOULD ANY AIR BAG INFLATORS BE RETURNED TO SUBARU OF AMERICA, INC.

Continued...

RECALL IDENTIFICATION LABEL

Type or print the necessary information on a Service Program identification label. The completed label should be attached to the vehicle's upper radiator support.

Additional labels are available through normal parts ordering channels. The part number is MSA6P1302. Ordering qty 1 = 1 sheet of 20 labels.

PART NUMBER	APPLICABILITY	DESCRIPTION	ORDER QUANTITY
MSA6P1302	All models	Campaign Completion Labels (contains one sheet of 20 labels)	1

SUBARU
Campaign Code
WQL-48
COMPLETED
DIST./DEALER NO.
SERIAL NO.
DO NOT REMOVE

CLAIM REIMBURSEMENT AND ENTRY PROCEDURES

Credit to perform this recall will be based on the submission of properly completed repair order information. Retailers may submit claims through 'Vehicle Claim Entry' on Subarunet.com.

Listed below is claim entry information:

CLAIM TYPE	CAMPAIGN CODE	LABOR	DESCRIPTION	LABOR TIME
RC	WQL-48	A182-031	Front Passenger Air Bag Inflator Replacement	0.7

PART NUMBER	APPLICABILITY	DESCRIPTION	QUANTITY
98279AE00A	Legacy, Outback, and Baja	WQL-48 Air Bag Inflator Module Kit	1
98279FE000	Impreza, WRX, and STI	WQL-48 Air Bag Inflator Module Kit	1

Miscellaneous Detail	Enter the serial number of the NEW air bag inflator installed in the "Misc. Details" field.
-----------------------------	--

Continued...

OWNER NOTIFICATION LETTER

IMPORTANT SAFETY RECALL

This notice applies to the VIN identified
in the address section printed below.



Subaru of America, Inc
Subaru Plaza
PO Box 6000
Cherry Hill, NJ 08034-6000
800-782-2783
www.subaru.com

Subaru Recall Campaign WQL-48
NHTSA Recall No. 14V-399
August 2014

Dear Subaru Owner:

This notice is sent to you in accordance with the National Traffic and Motor Vehicle Safety Act.

SUBARU OF AMERICA, INC. has decided that a defect, which relates to motor vehicle safety, exists in certain 2003-2004 model year Legacy, Outback, and Baja vehicles, and certain 2004 model year Impreza, WRX, and STI vehicles.

You received this notice because our records indicate that you currently own one of these vehicles.

DESCRIPTION OF THE SAFETY DEFECT AND SAFETY HAZARD

Subaru was notified by its supplier that the subject vehicles are equipped with front passenger air bag inflators which could have been assembled with improperly manufactured propellant wafers. In the event of a crash necessitating deployment of the passenger side frontal air bag, improperly manufactured propellant wafers could cause the inflator to rupture with metal fragments striking and potentially seriously injuring the vehicle occupants.

REPAIR

Subaru will replace the inflator for your front passenger air bag at no cost to you.

WHAT YOU SHOULD DO

You should immediately contact your Subaru retailer (dealer) for an appointment to have the front passenger air bag inflator replaced with a new one.

HOW LONG WILL THE REPAIR TAKE?

The time to replace the front passenger air bag inflator is approximately 40 minutes. However, it may be necessary to leave your vehicle for a longer period of time on the day of your scheduled appointment to allow your Subaru retailer flexibility in scheduling. Please present this letter to your Subaru retailer at the time this repair procedure is performed.

CHANGED YOUR ADDRESS OR SOLD YOUR SUBARU?

If you have moved or sold your vehicle, please complete the enclosed prepaid postcard and mail it to us. Or, if you prefer to update this information online, please go to www.subaru.com, select Contact Us then select Update Address from the drop down menu.

Continued...

IF YOU NEED FURTHER ASSISTANCE:

To locate the nearest Subaru Dealer you can access our website at www.subaru.com and select “Find a Dealer”.

For additional information and the most Frequently Asked Questions, please go to:

- <http://www.wql48.service-campaign.com>

If you need additional assistance, please contact us directly:

- E-mail: Go to www.subaru.com and select “Contact Us”.
- Telephone: 1-800-SUBARU3 (1-800-782-2783)
Monday through Thursday between 7:30 a.m. and 8:00 p.m. ET.
Friday between 10:30 a.m. and 5:00 p.m. ET
Saturday between 9:00 a.m. and 3:30 p.m. ET
- U.S. Postal mail: Write us at Subaru of America, Inc.
Attn: CDS Department, P.O. Box 6000, Cherry Hill, NJ 08034-6000.

Please contact us immediately if the Subaru retailer fails or is unable to make the necessary repairs free of charge.

You may also contact the Administrator, National Highway Traffic Safety Administration, 1200 New Jersey Ave. SE, West Building, Washington, DC 20590 or call the toll free Auto Safety Hotline at 1-888-327-4236 (TTY: 1-800-424-9153) or go to <http://www.safercar.gov> if you believe the Subaru retailer has failed or is unable to remedy your vehicle without charge within a reasonable amount of time.

Your continued satisfaction with your Subaru is important to us. Please understand that we have taken this action in the interest of your safety and your vehicle’s proper operation. We sincerely apologize for any inconvenience this matter may cause and urge you to schedule an appointment as soon as possible to have this repair performed.

Sincerely,
Subaru of America, Inc.

Notice to Lessors: Under Federal law the lessor of a vehicle who receives this letter must provide a copy of it to the vehicle lessee(s) within 10 business days from receipt. The lessor must also keep a record of the lessee(s) to whom this letter is sent, the date sent, and the applicable vehicle identification number (VIN). (For the purposes of this section, a lessor means a person or entity that in the last twelve months prior to the date of this notification has been the owner, as referenced on the vehicle’s title, of any five or more leased vehicles. A leased vehicle is a vehicle leased to another person for a term of at least four months.)

A subsidiary of Fuji Heavy Industries Ltd.

SHIPPING DOCUMENTATION AND INSTRUCTIONS (Appendix A)

CAMPAIGN WQL48 – 48 STATE FEDEX GROUND SHIPMENT PREPARATION

As the shipper, you are responsible for proper packing and document completion. The person packaging the inflator must have received hazardous material training per 49CFR 172.702, and the training records must be on file at your dealership. The US Department of Transportation will impose substantial fines and/or penalties on the shipper if either packaging, labeling or documentation is not properly prepared and Customer Copy of OP 900PRP form is not kept on file for a minimum of 2 years.

IMPORTANT: Do not deploy any inflator. Return the used inflator within 1-2 business days. The person packing the used inflator must read and follow the provided instructions.

NOTE: Dealers in **Alaska, Canada, Hawaii, and Puerto Rico CANNOT** follow these shipping instructions. The dealer **MUST** contact the following Takata USA representative directly for shipping instructions: Miguel Prigadaa – Tel #: 210-250-5078 or Email: MLGTakataRestrains_International@menloworldwide.com

1. Shipping Documents

OP 900PRP Hazardous Materials Certification Form



FedEx Ground Shipping Label



FedEx Ground Shipping Envelope



5. Shipping Documentation Instructions (Cont.)

a) Fill in the following on the FedEx Copy and the customer copy:

- Shipper Name (dealer)
- Address
- CCN (The CCN # can be found in the enclosed Subaru dealer list. If you are unable to locate your CCN, please contact Cheryl Malloy at Takata: Cheryl.Malloy@Takata.com or TEL # 843-537-8284)

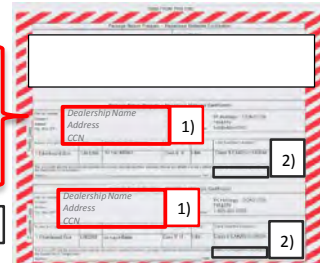

b) Date the FedEx Copy and Customer copy (MM/DD/YY)

2. Packing Instructions

a) Confirm box is in acceptable condition. If a new box is needed, follow the New Box instructions located on the next page.

b) Place the un-deployed air bag inflator in the "cradle" of the box insert, with a completed SOA warranty parts tag (MSA5W402A) attached to it. The tag must contain the following information: Claim No, Repair Date, 17-digit VIN, and Mileage



6. Shipping Documentation Instructions (Cont.)

a) Peel off the SHIPPER RECEIPT from the top of the FedEx Ground PRP Shipping label, place it in the Tracking ID box on the Customer Copy of the OP 900PRP form.

b) Peel off the RECEIPT & SHIPPER NUMBER from the top of the FedEx Ground PRP Shipping label, and place it in the Tracking ID box on the FedEx copy.



3. Closure Instructions

a) Close the top box flap, per box closure instructions located on front panel of box.

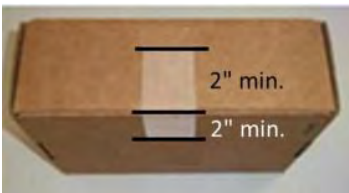

7. Shipping Documentation Instructions (Cont.)

a) Separate the FedEx Copy and Customer Copy of the OP 900PRP form. Keep the FedEx copy with the box. Attach the Customer Copy to the Repair Order.

Note: Dealers must retain the Customer Copy of OP 900PRP form in their records for 2 years.



4. Shipping Documentation Instructions

a) Separate the bottom 4 labels (OP 900PRP form), place them in the FedEx Ground envelope, remove the backing and firmly place on bottom side of box.

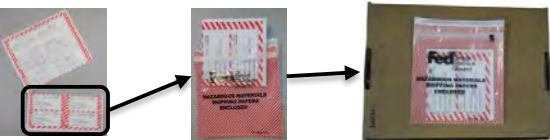

b) Peel off the Box Copy of the OP 900PRP form and firmly apply to the front side of the box.

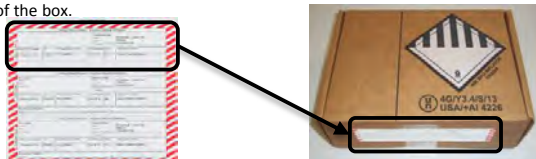

8. FedEx Ground PRP Shipping label

a) Fill in Shipper Name & Address in the upper section of the FedEx Ground Shipping label. Note: (RMA# is not required).

b) Peel off the backing of the FedEx Ground PRP Shipping label and affix to top of box to left of the Class 9 label.

- Use the scribe line on the box as a guide
- The FedEx Ground PRP Shipping label must not touch any portion of the printing to the right of the scribe line.

c) Provide the package and the FedEx Copy of the OP 900PRP form to the FedEx Ground Driver.

Note: If you don't receive regular pickups from FedEx, call 888-777-6040 to schedule a pickup of the package.

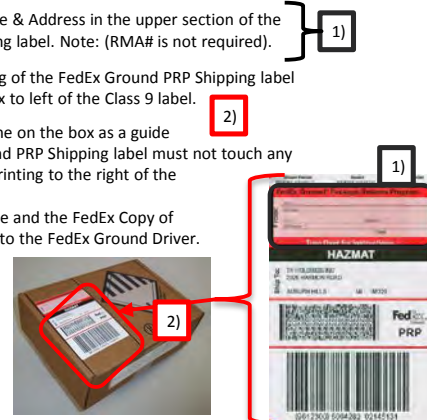

Continued...

Requesting a New Box / Shipping Labels

If a new box or replacement shipping labels are needed, please contact a Takata USA representative listed below by phone or email to request replacement materials.

Primary Contact: **Miguel Prigadaa - Tel #: 210-250-5078**

E-Mail: MLGTakataRestraints_International@menlowworldwide.com

To help expedite your request, please be prepared to provide the following information:

- a) Serial number on the original box
- b) What Type of shipping material needed
 - OP-900prp Hazardous Materials Certification Form
 - FedEx Ground Shipping Label
 - FedEx Ground Shipping Envelope
- c) Dealer Shipping Information
 - Contact name
 - Dealer address
 - Phone Number

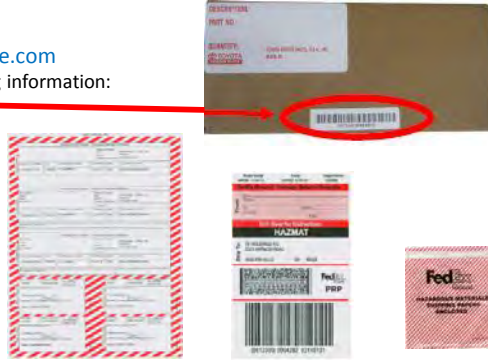

ATTENTION SOA DEALERS →

IMPORTANT: All removed air bag inflators must be returned directly to Takata USA as described in this shipment document and in the recall bulletin.

Upon claim approval, Subaru of America, Inc. will generate a parts return notice to you, requesting the following information:

- The FedEx Shipper Receipt #
- The OLD and NEW air bag inflator serial numbers

To ensure proper claim credit, the above information must be recorded on the Part Return Notice and sent to SOA Part Collection Center as instructed on the Return Notice.

The instructions on the Return Notice will read as follows:

IMPORTANT: Part should be returned to Takata as instructed in Recall Bulletin. Note the FedEx Shipper #, the OLD and NEW serial number on this form and return to the address below.

Under no circumstances should the air bag inflator be returned to Subaru of America, Inc.

Continued...

CCN LIST (Appendix B)

If you are unable to locate your CCN, please contact Cheryl Malloy at Takata: Cheryl.Malloy@Takata.com or TEL # 843-537-8284

Subaru Dealer code	CCN
010101	708201
010108	708240
010126	708228
010132	708241
010141	708189
010143	708215
010145	708229
010147	708230
010150	708216
010153	708190
010157	708242
010166	708202
010168	708217
010172	708203
010182	708191
010185	708243
010187	708244
010191	708204
010194	708231
010199	708218
010201	708232
010205	708233
010209	708234
010212	708192
010217	708219
010220	708245
010225	708205
010231	708220
010232	708206
010237	708235
010241	708221
010243	708222
010246	708207
010255	708246
010261	708247
010266	708193
010270	708208
010287	708209
010296	708248
010335	708210
010350	708194
010351	708195
010355	708211
010356	708249
010357	708236
010358	708237
010359	708223
010371	708224
010372	708212
010373	708196
010377	708225
010378	708213
010379	708197
010383	708198
010384	708214
010385	708238
010386	708239
010387	708226
010388	708199
010389	708250
010390	708200
010391	708251
010392	708227
020125	708296
020128	708306
020131	708285

Subaru Dealer code	CCN
020138	708274
020143	708297
020144	708275
020145	708252
020148	708276
020151	708307
020155	708277
020161	708298
020162	708286
020163	708253
020165	708287
020166	708308
020167	708288
020171	708278
020175	708309
020182	708254
020183	708255
020184	708263
020186	708256
020187	708289
020190	708264
020194	708257
020196	708290
020197	708310
020198	708311
020199	708258
020200	708291
020204	708292
020205	708279
020206	708312
020207	708265
020208	708266
020209	708267
020211	708293
020215	708259
020216	708299
020218	708268
020219	708269
020220	708270
020222	708271
020223	708260
020224	708280
020225	708300
020227	708301
020229	708302
020230	708294
020236	708295
020244	708303
020249	708304
020250	708281
020255	708282
020256	708283
020259	708261
020264	708313
020273	708272
020279	708314
020283	708315
020284	708305
020286	708273
020287	708284
020289	708262
020290	708316
030102	708331
030112	708356
030114	708345
030118	708317

Subaru Dealer code	CCN
030121	708346
030129	708332
030130	708366
030131	708318
030132	708333
030133	708319
030134	708334
030135	708335
030136	708367
030139	708336
030141	708347
030142	708320
030143	708321
030144	708322
030145	708368
030149	708357
030150	708358
030151	708359
030158	708348
030161	708360
030162	708337
030164	708369
030168	708370
030169	708371
030170	708323
030172	708324
030180	708372
030181	708325
030182	708373
030186	708338
030197	708412
030201	708339
030207	708374
030210	708388
030212	708375
030214	708376
030219	708326
030220	708327
030225	708340
030226	708349
030230	708361
030232	708362
030235	708341
030237	708363
030242	708413
030247	708377
030249	708389
030258	708414
030260	708378
030263	708390
030268	708379
030277	708415
030281	708391
030290	708416
030291	708328
030292	708350
030294	708364
030295	708380
030296	708351
030301	708352
030302	708342
030306	708353
030310	708329
030311	708381
030313	708382
030314	708330

Subaru Dealer code	CCN
030315	708392
030356	708383
030378	708393
030415	708394
030481	708384
030560	708395
030618	708417
030619	708396
030648	708385
030660	708418
030661	708419
030672	708420
030674	708386
030675	708399
040100	708400
040103	708446
040123	708447
040132	708401
040135	708402
040171	708433
040198	708423
040209	708403
040221	708448
040229	708434
040232	708404
040238	708472
040261	708459
040272	708405
040294	708460
040301	708435
040339	708424
040346	708496
040357	708449
040384	708473
040398	708474
040399	708436
040403	708450
040404	708421
040427	708437
040428	708475
040438	708451
040446	708476
040451	708406
040458	708452
040459	708461
040475	708477
040477	708407
040483	708462
040486	708453
040491	708438
040503	708425
040533	708463
040535	708426
040554	708454
040561	708464
040565	708455
040566	708627
040573	708408
040574	708465
040576	708439
040577	708497
040578	708409
040582	708628
040585	708427
040586	708639
040587	708486

Subaru Dealer code	CCN
040588	708456
040589	708498
040599	708466
040602	708629
040605	708487
040617	708499
040621	708640
040622	708630
040623	708410
040624	708467
040632	708631
040634	708500
040635	708488
040641	708478
040643	708632
040644	708489
040647	708501
040650	708428
040654	708440
040657	708429
040658	708411
040659	708441
040669	708479
040673	708490
040682	708605
040690	708606
040698	708633
040721	708442
040724	708491
040725	708634
040730	708502
040731	708503
040733	708641
040736	708651
040738	708652
040739	708635
040741	708653
040743	708654
040750	708468
040756	708469
040757	708504
040833	708655
040835	708656
040910	708657
040917	708642
040928	708658
040929	708643
040950	708659
040963	708644
040982	708645
070100	708564
070101	708507
070116	708617
070117	708535
070128	708607
070129	708521
070136	708593
070141	708608
070145	708579
070151	708536
070155	708618
070161	708550
070173	708609
070174	708594
070179	708595
070203	708537

Continued...

If you are unable to locate your CCN, please contact Cheryl Malloy at Takata: Cheryl.Malloy@Takata.com or TEL # 843-537-8284

Subaru Dealer code	CCN
070218	708522
070225	708596
070233	708580
070240	708538
070241	708508
070243	708551
070261	708581
070263	708523
070283	708582
070291	708565
070298	708509
070347	708583
070359	708524
070361	708610
070362	708584
070370	708552
070372	708597
070378	708525
070379	708553
070399	708510
070416	708526
070420	708554
070421	708511
070425	708611
070433	708619
070436	708585
070438	708539
070440	708540
070443	708612
070449	708598
070453	708512
070454	708513
070456	708586
070457	708566
070458	708541
070459	708620
070464	708621
070467	708542
070469	708543
070471	708514
070473	708599
070475	708622
070479	708600
070480	708527
070481	708544
070484	708545
070485	708555
070486	708613
070490	708528
070491	708515
070492	708516
070495	708601
070497	708567
070502	708568
070521	708556
070527	708569
070528	708570
070529	708557
070532	708558
070534	708571
070548	708572
070550	708529
070551	708573
070552	708559
070553	708546
070554	708623
070557	708560
070560	708587

Subaru Dealer code	CCN
070568	708530
070572	708574
070573	708561
070575	708602
070578	708614
070579	708517
070587	708588
070590	708589
070593	708531
070594	708562
070596	708615
070598	708575
070599	708576
070602	708590
070751	708563
070844	708532
070874	708533
090179	708680
090180	708662
090183	708681
090185	708663
090207	708682
090223	708664
090342	708665
090345	708666
090473	708670
090491	708683
090507	708684
090525	708667
090528	708685
090535	708686
090537	708671
090542	708672
090543	708673
090597	708801
090651	708782
090652	708773
090664	708792
090667	708783
090670	708793
090677	708674
090681	708794
090694	708795
090707	708802
090747	708784
090752	708687
090753	708675
090754	708796
090768	708797
090771	708668
090772	708774
090775	708803
090777	708775
090782	708804
090784	708776
090787	708798
090794	708785
090796	708786
090797	708669
090798	708805
090799	708660
090801	708676
090802	708806
140100	708712
140101	708713
140111	708722
140138	708765
140140	708744

Subaru Dealer code	CCN
140151	708745
140156	708723
140162	708755
140172	708733
140175	708766
140189	708714
140192	708701
140193	708702
140203	708734
140214	708715
140230	708690
140240	708735
140242	708716
140243	708703
140245	708736
140246	708724
140258	708691
140265	708737
140274	708738
140275	708692
140276	708704
140278	708705
140279	708706
140377	708693
140383	708694
140389	708739
140408	708717
140409	708695
140413	708696
140486	708767
140494	708756
140511	708768
140514	708757
140516	708769
140524	708746
140529	708747
140533	708697
140538	708707
140548	708740
140550	708748
140552	708718
140555	708770
140560	708758
140588	708708
140593	708749
140596	708725
140647	708698
140659	708719
140666	708699
140668	708726
140671	708720
140676	708741
140689	708742
140697	708677
140705	708727
140714	708721
140717	708750
140718	708751
140768	708771
140769	708743
140771	708709
140772	708759
140773	708752
140776	708760
140777	708761
140779	708710
400005	708624
400009	708492

Subaru Dealer code	CCN
400020	708807
400043	708787
400048	708728
400054	708577
400058	708480
400059	708481
400060	708636
400061	708518
400063	708519
400064	708762
400065	708625
400069	708763
400071	708482
400072	708637
400099	708387
400101	708483
400103	708430
400105	708431
400106	708788
400144	708626
400145	708493
400159	708777
400183	708772
400201	708470
400202	708646
400205	708778
400210	708764
400230	708799
400293	708647
400310	708729
400316	708779
400331	708688
400332	708397
400350	708678
400353	708789
400370	708800
400391	708730
400432	708471
400453	708494
400472	708780
400532	708520
400552	708505
400572	708790
400612	708661
400712	708443
400732	708444
400852	708638
400960	708591
400992	708753
401014	708495
401032	708354
401047	708648
401068	708603
401120	708547
401136	708711
401139	708578
401146	708616
401147	708604
401157	708649
401158	708506
401187	708484
401190	708731
401191	708700
401192	708457
401213	708398
401214	708791
401232	708548
401252	708485

Subaru Dealer code	CCN
401271	708650
401277	708808
401278	708365
401285	708754
401286	708432
401289	708592
401312	708534
401313	708679
401346	708422
401374	708445
401395	708732
401396	708355
401408	708549
401559	708343
401560	708781
401605	708344
401606	708458
401607	708689