



---

# SERVICE CAMPAIGN BULLETIN

---

Reference:

NTB12-100

Date:

November 8, 2012

## VOLUNTARY SERVICE CAMPAIGN 2009 – 2011 VERSA SEDAN SPEEDOMETER AND ODOMETER INACCURACY

**CAMPAIGN ID #:** P2508**APPLIED VEHICLES:** 2009 – 2011 Versa (C11)**Check Service COMM to confirm campaign eligibility.**

### INTRODUCTION

On certain model year 2009 – 2011 Nissan Versa Sedan vehicles the speedometer and/or odometer may be reading out of specification. To remedy this condition, Nissan is conducting this voluntary service campaign to recalibrate the speedometer and/or odometer at no charge for parts or labor.

### IDENTIFICATION NUMBER

Nissan has assigned identification number P2508 to this campaign. This number must appear on all communications and documentation of any nature dealing with this campaign.

### DEALER RESPONSIBILITY

Dealers are to repair vehicles falling within range of this campaign that enter the service department. This includes vehicles purchased from private parties, vehicles presented by transient (tourists) owners, and vehicles in a dealer's inventory.

Nissan Bulletins are intended for use by qualified technicians, not 'do-it-yourselfers'. Qualified technicians are properly trained individuals who have the equipment, tools, safety instruction, and know-how to do a job properly and safely. NOTE: If you believe that a described condition may apply to a particular vehicle, DO NOT assume that it does. See your Nissan dealer to determine if this applies to your vehicle.

## REPAIR OVERVIEW

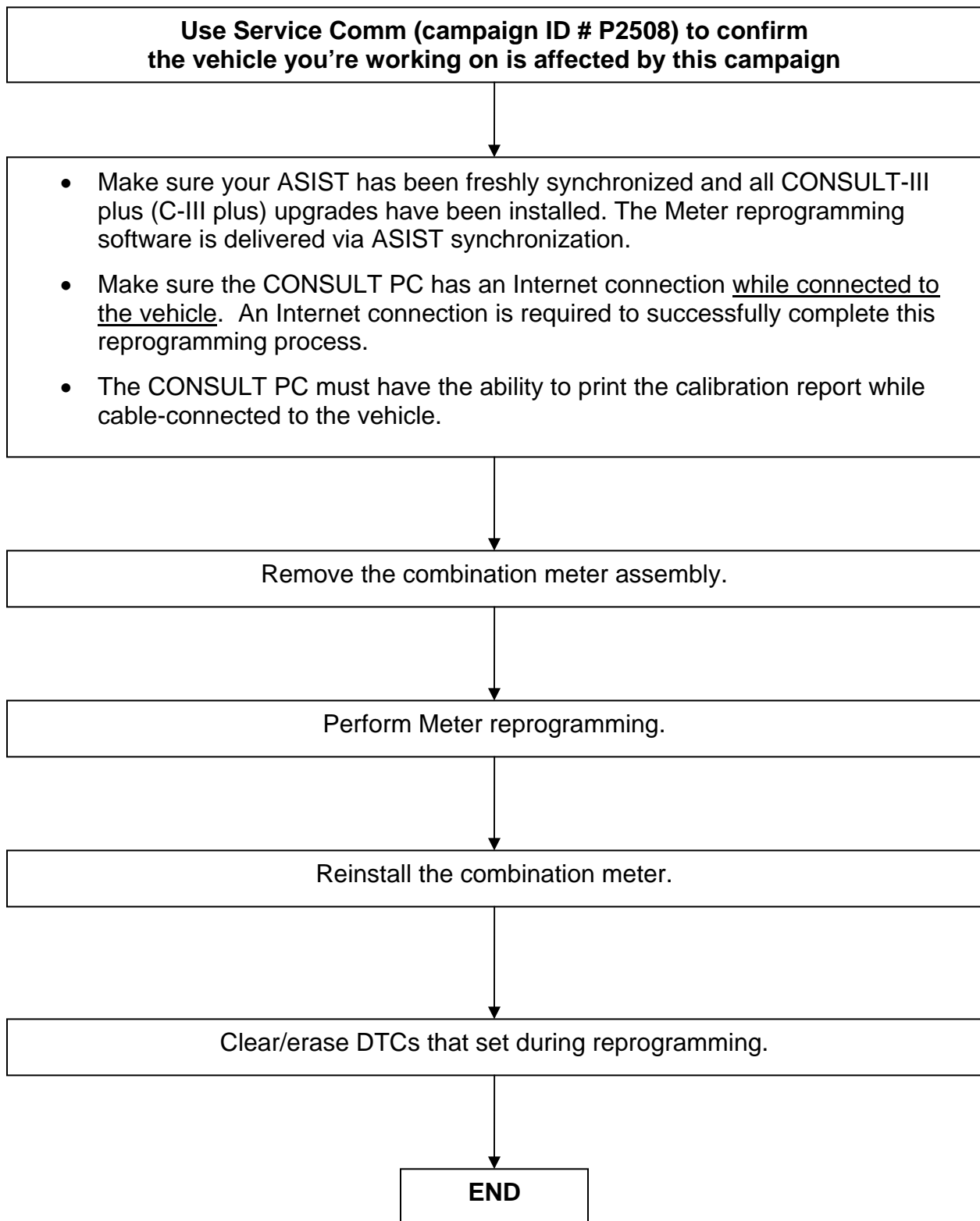

## REQUIRED SPECIAL TOOL – Versa Reprogram Tool (J-50777)

- Each dealer will be shipped, at no charge, one Versa Reprogram Tool.
- Additional tools can be ordered from Tech-Mate at 1-800-662-2001.

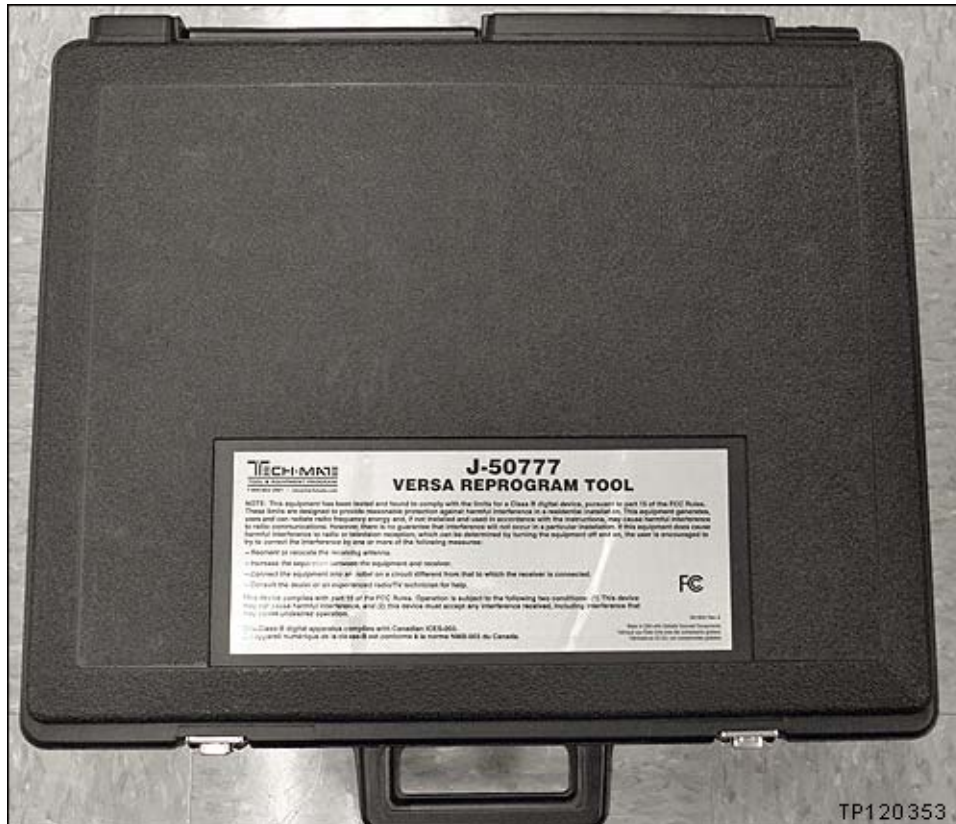

### NOTE:

- The above reprogramming tool and the reprogramming software (delivered via ASIST synchronization) can only be applied to vehicles affected by this campaign (campaign ID # P2508).
- The software will not allow reprogramming of vehicles that are not affected by this campaign. Also, the software will not allow reprogramming of vehicles that have already been reprogrammed.
- The reprogramming can only be applied one time to each affected vehicle. Vehicle identification is validated against data located on NNA's servers before reprogramming is allowed.

## SERVICE PROCEDURE

### Combination Meter Removal

1. Adjust and lock the steering column to the Full Down position.
2. Remove instrument finisher E as follows (see Figure 1).
  - a. Use a plastic trim tool to raise the front edge.
  - b. Grasp and pull rearward (toward you) to unsnap and remove.



Figure 1

3. Pull the driver's door seal loose in the area shown in Figure 2.



Figure 2

4. Snap loose and remove the A-pillar finisher.
  - Use a plastic trim tool as needed.



Figure 3

5. Snap loose and remove the instrument side panel LH.
  - Use a plastic trim tool as needed.



Figure 4

6. Snap loose and remove the instrument side finisher.
  - Use a plastic trim tool as needed.



Figure 5

7. Remove the instrument side mask LH (vent finisher LH) as follows:

- a. Use a hook tool to release the lower clips (see Figure 6).

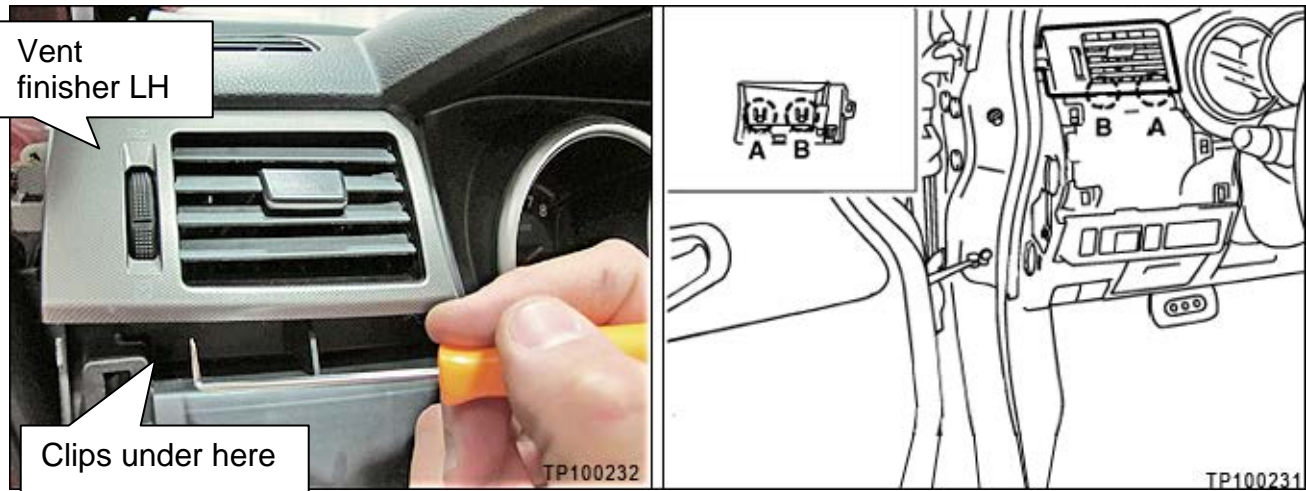

Figure 6

- b. Lift the bottom of the vent finisher UP then pull to unsnap the upper clips.

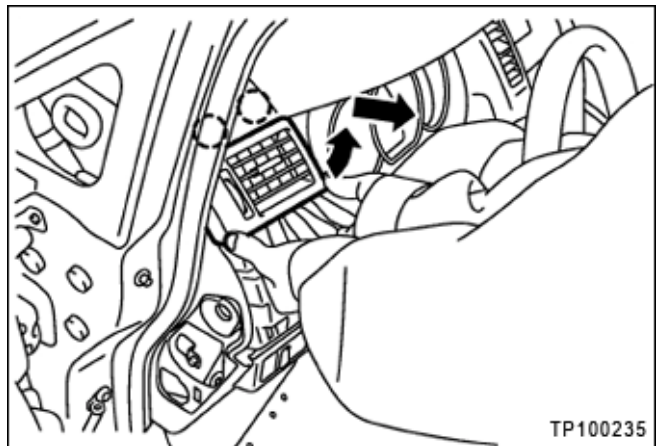

Figure 7

8. Remove the bolt shown in Figure 15.

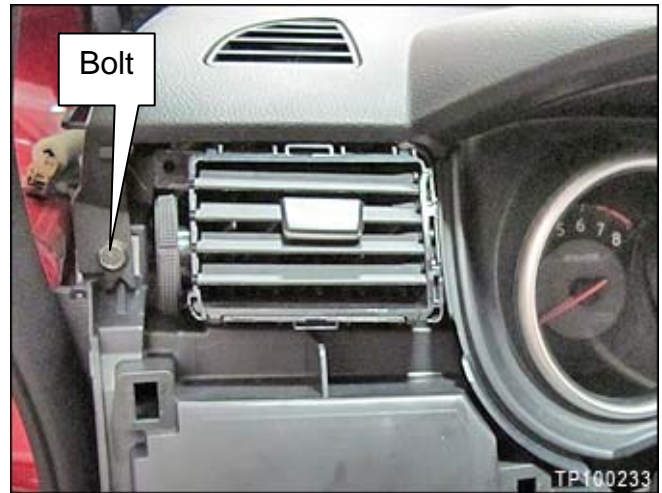

Figure 8

9. Remove the steering column upper cover as follows:
  - a. Remove 1 screw from the bottom.

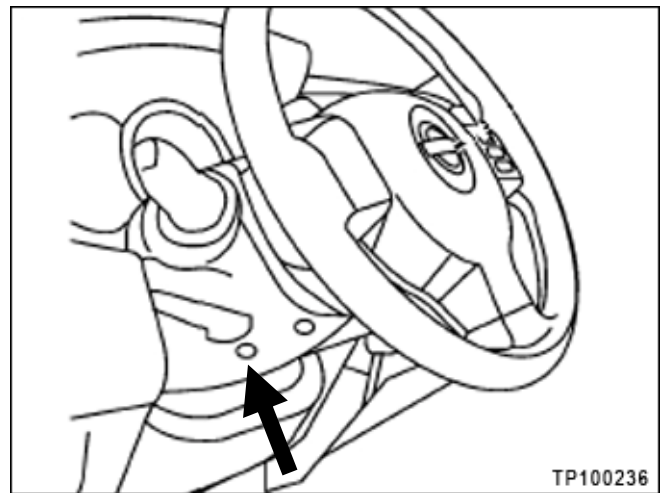

Figure 9

- b. Snap loose and remove the steering column upper cover.



Figure 10

10. Cover the steering column with a fender cover or other protective cloth to prevent scratching of the meter lens.

**CAUTION:** Be careful; do not scratch the clear meter lens.

11. Remove cluster lid A as follows:

- a. Push up on the instrument panel to snap it loose from cluster lid A.
- b. Grasp cluster lid A and pull it rearward (toward you) to unsnap and remove it.

**NOTE:** Approximate clip locations are shown in Figure 11.

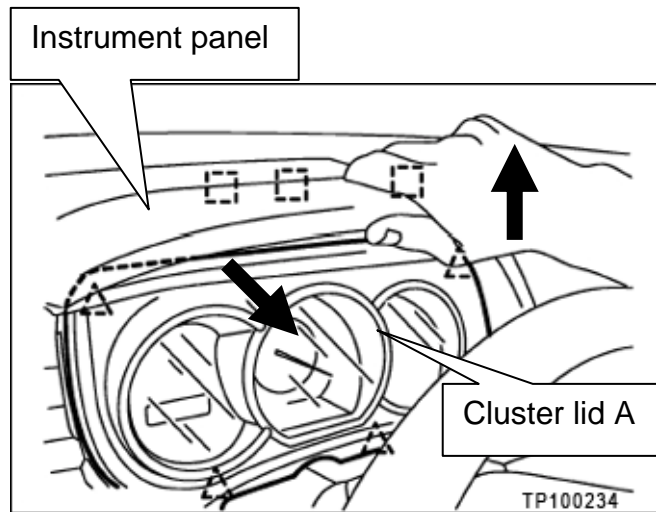

Figure 11

12. Remove the combination meter as follows:

- a. Remove screw **A** shown in Figure 12.
- b. Carefully pull the combination meter rearward (toward you) to unsnap lower clips **B**.
- c. Pull the meter far enough rearward (toward you) to tilt it and access the electrical connector.

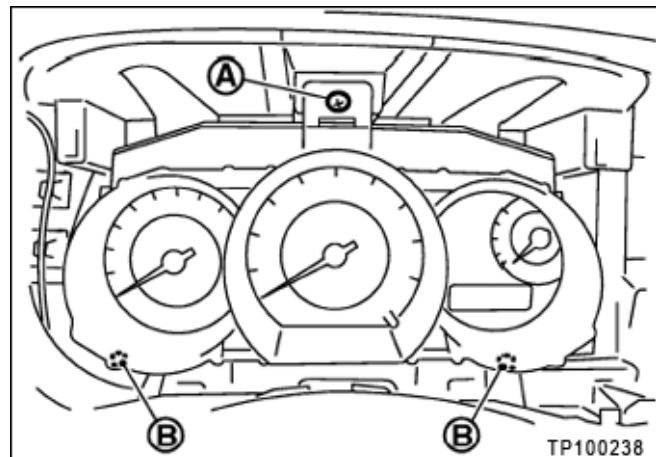

Figure 12



- d. Use a plastic trim tool to unlatch and disconnect the electrical connector.

13. Remove the combination meter from the vehicle.

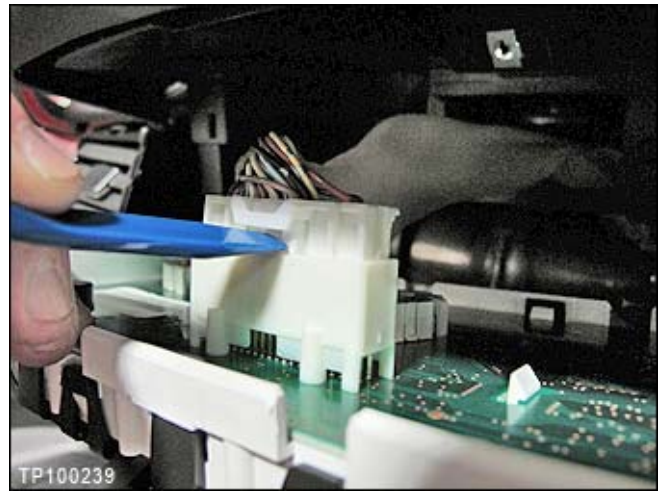

Figure 13

### **Prepare for Reprogramming**

1. Attach the combination meter to the Reprogramming Tool J-50777 as follows:

- a. Connect the Reprogramming Tool meter cable to the back of the combination meter.

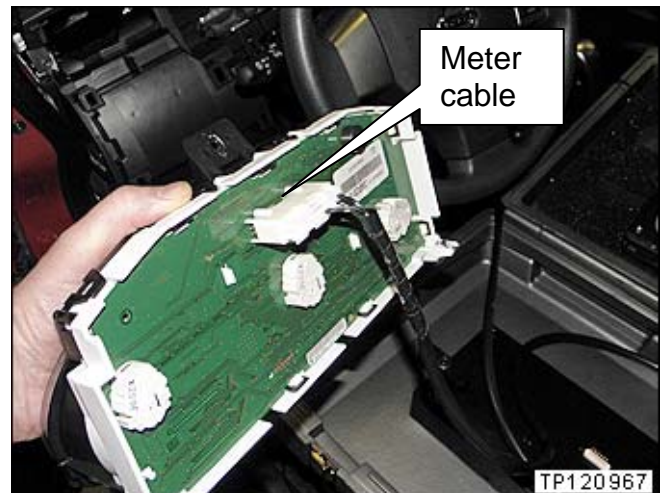

Figure 14

- b. Connect the other end of the Reprogramming Tool meter cable to the combination meter harness.

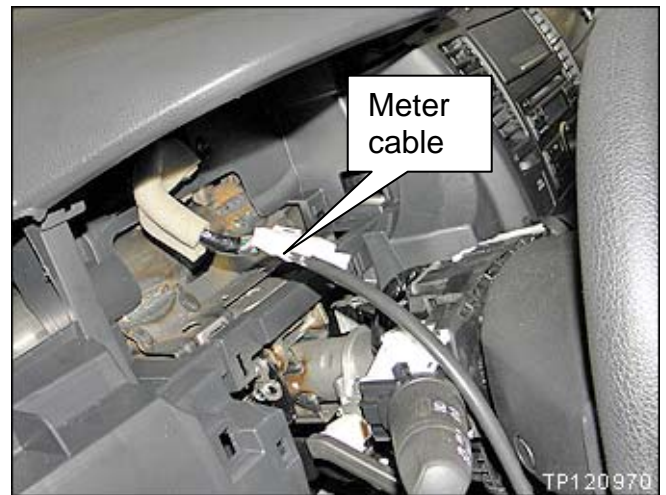

Figure 15

- c. Inspect the electrical contacts on the Reprogramming Tool. Make sure they are not damaged (see Figure 16).
- d. Secure the combination meter on the Reprogramming Tool platform (see Figures 16 and 17).
  - Electrical contacts on the tool platform need to touch the electrical contacts on the meter.
  - Clips on meter fit into side slots on the platform.

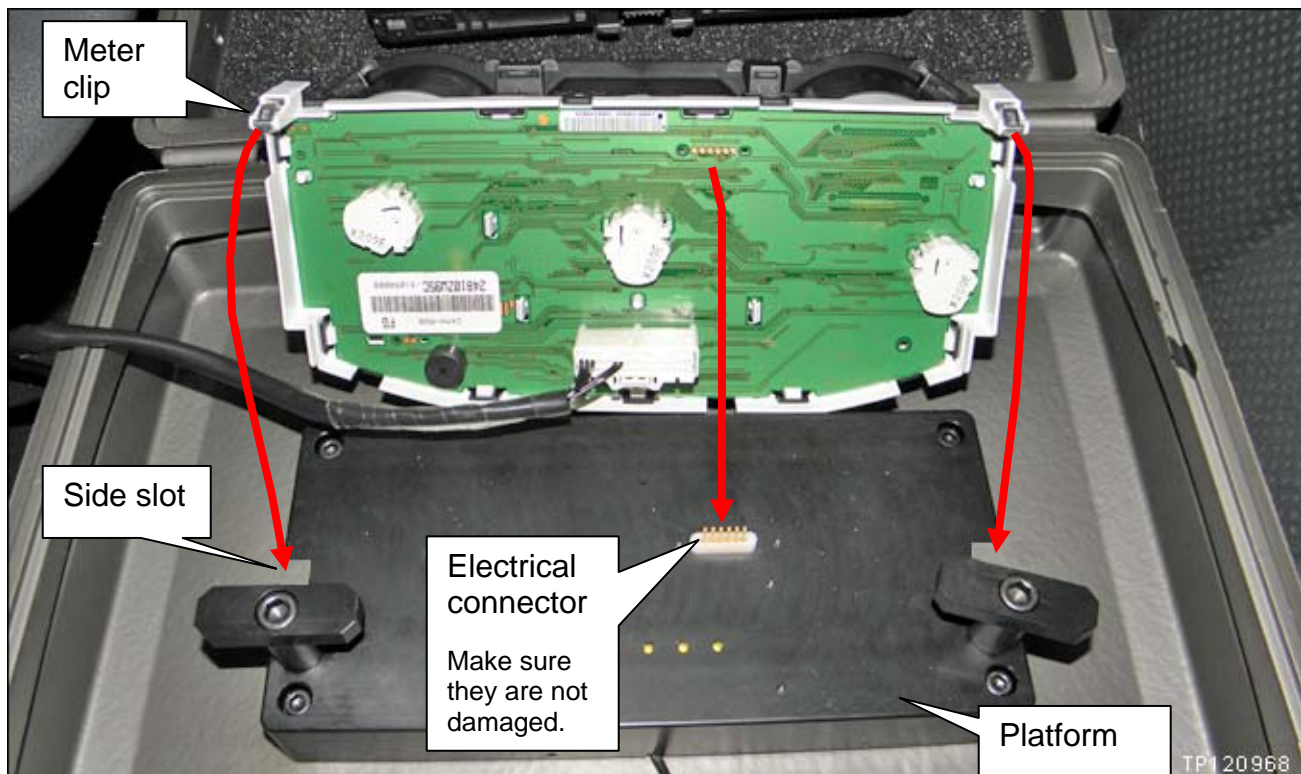

Figure 16

- Use the spring-loaded locks to hold the combination meter in place (see Figure 17 and 18).

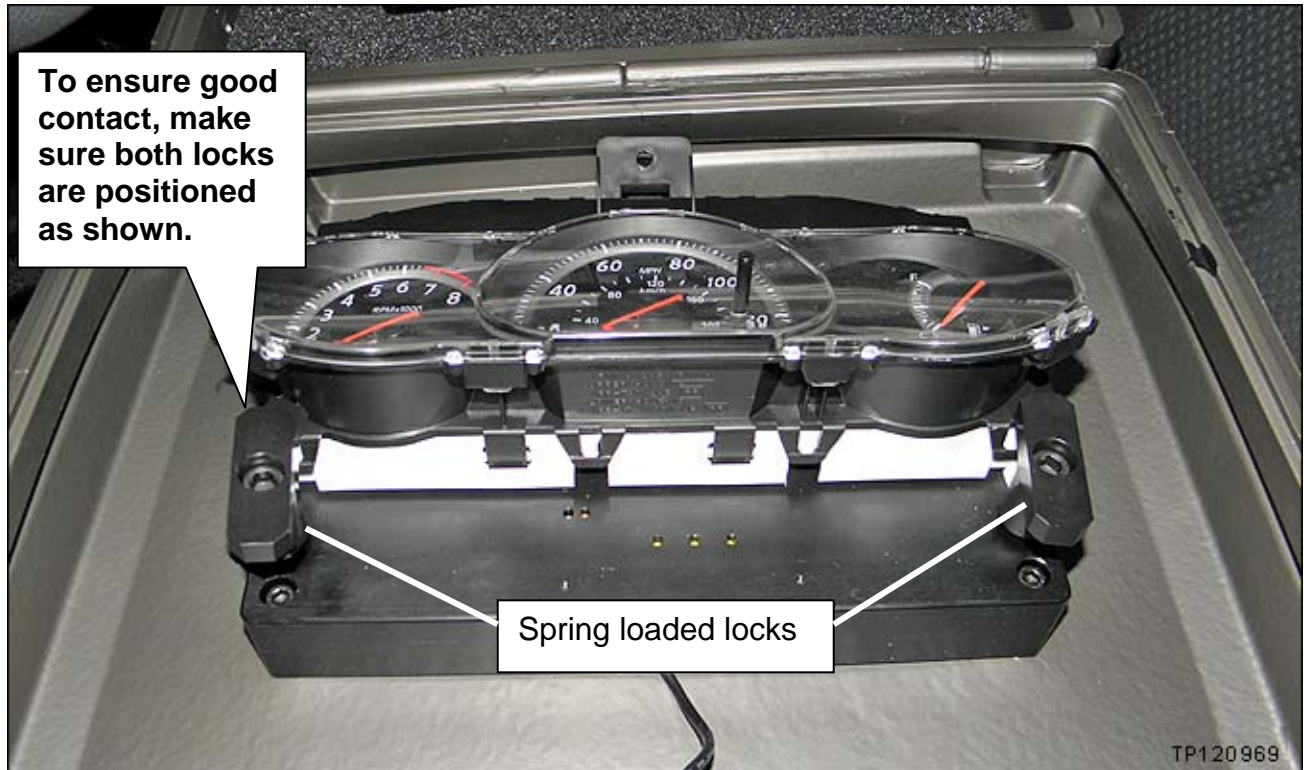

Figure 17



Figure 18

2. Connect the USB cable from the Reprogramming Tool to the CONSULT PC (see Figure 19).
3. Connect the AC Adapter to the CONSULT PC (see Figure 19).



Figure 19

4. Connect the C-III plus VI to the vehicle.



Figure 20

5. Connect a battery charger to the vehicle battery set to a 20 amp charge rate.
  - The GR-8 (Battery and Electrical Diagnostic Station) set to “Power Supply” mode is recommended.



Figure 21

TP080203

## **Reprogram the Meter**

### **IMPORTANT:**

- Before starting, make sure your ASIST has been freshly synchronized and all C-III plus upgrades have been installed. The Meter reprogramming software is delivered via ASIST synchronization.
- This reprogramming process requires an Internet connection. Make sure the CONSULT PC has an Internet connection (cable or WI-FI) before starting.
- The CONSULT PC must have the ability to print the calibration report while cable-connected to the vehicle.
- The software will not allow reprogramming of vehicles that are not affected by this campaign.
- The reprogramming can only be applied one time to each affected vehicle. Vehicle identification is validated against data located on NNA's servers before reprogramming is allowed.

## Pre Start Check List

- ASIST freshly synchronized
- Internet connection for CONSULT PC
- Meter cable securely connected – both ends
- Spring locks for meter correctly in place
- USB cable from Reprogramming Tool to CONSULT PC securely connected
- AC Adapter for CONSULT PC connected
- C-III plus VI securely connected to the vehicle DLC
- GR-8/battery charger connected to the vehicle battery

1. Turn the Ignition ON.

**NOTE:** With the ignition ON, the meter will light up and the odometer will display the mileage.

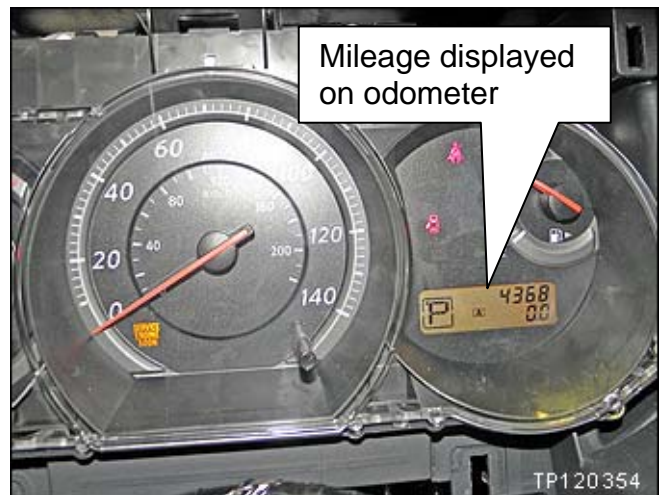

Figure 1a

2. Turn ON the CONSULT PC (do not start C-III plus at this time).
  - The first time the reprogramming kit (PC converter box) is attached to either of the C-III USB ports, the following screens (Figures 1b – 1d on the next page) will display.
  - If this **is not** the first time, these screens will not display – go to step 3 on page 15.

a. Select **Install the software automatically (Recommended)**.

b. Select **Next**.



Figure 1b

c. Select **Continue Anyway**.



Figure 1c

d. Select **Finish**.

e. Disconnect and then reconnect the USB cable at the CONSULT PC.



Figure 1d

3. The left side LED on the Reprogramming tool should be ON and Green (see Figure 1e).
  - LED is Green; go to the next step.
  - LED is not ON or is Red; the Reprogramming Tool may need repair. Call Tech-Mate at 1-800-662-2001 for assistance.

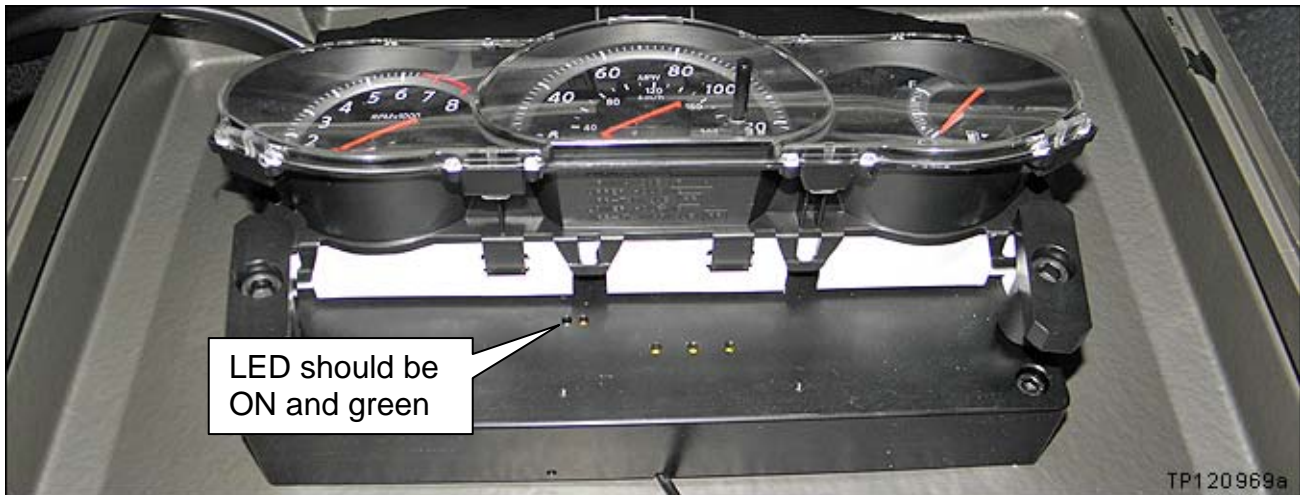

Figure 1e

4. Open/start ASIST.
5. Select **Specialty Tools** and then **C11 Odometer Calibration Tool**.

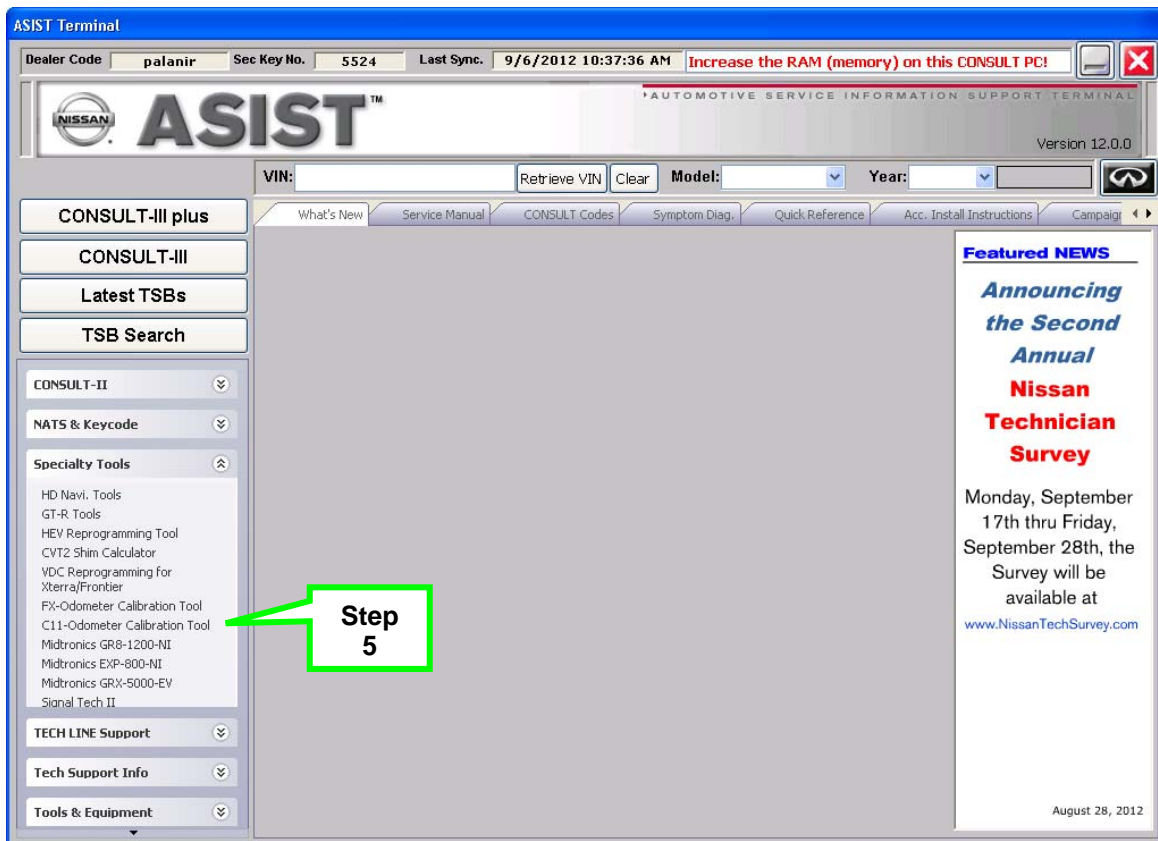

Figure 1f



6. After selecting **C11 Odometer Calibration Tool**, C-III plus will launch automatically.
7. Wait for the plus VI to be recognized.
  - Serial number will display when the plus VI is recognized.

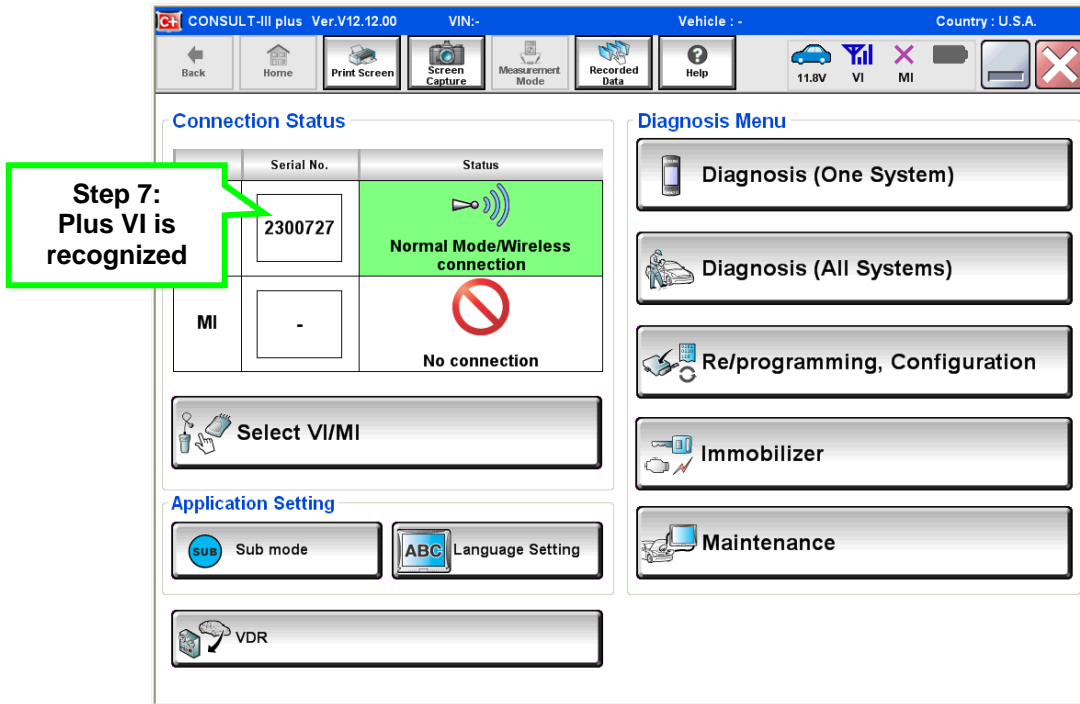

Figure 1g

8. Select **Diagnosis (All Systems)**.

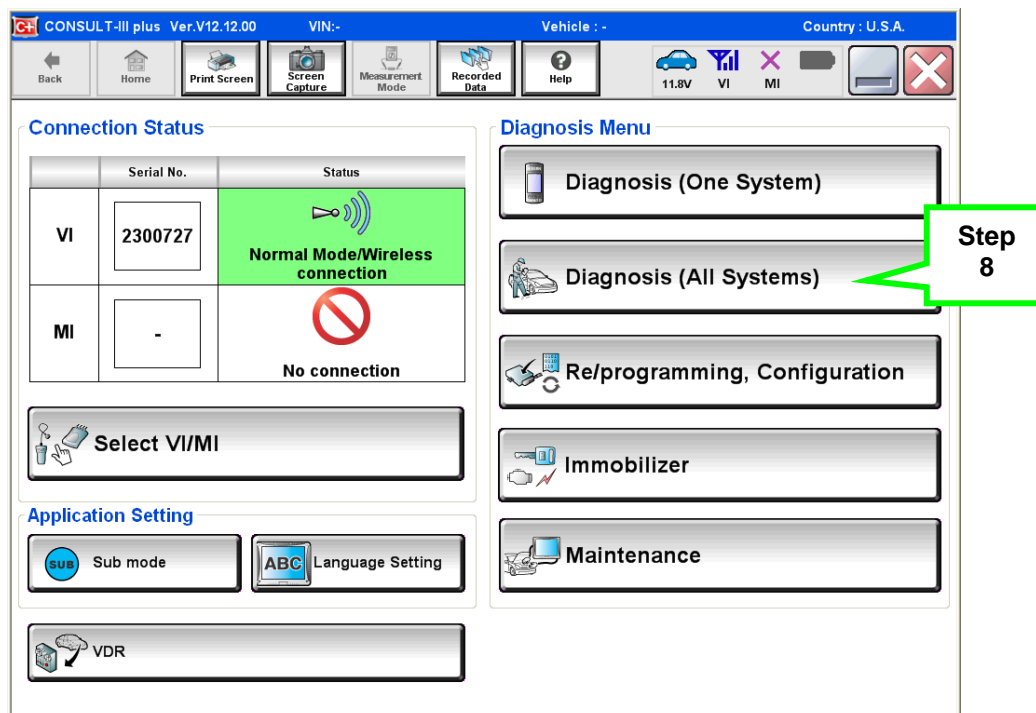

Figure 1h

9. Make sure **VIN or Chassis #** matches the vehicle's VIN.

10. Select **Confirm**.

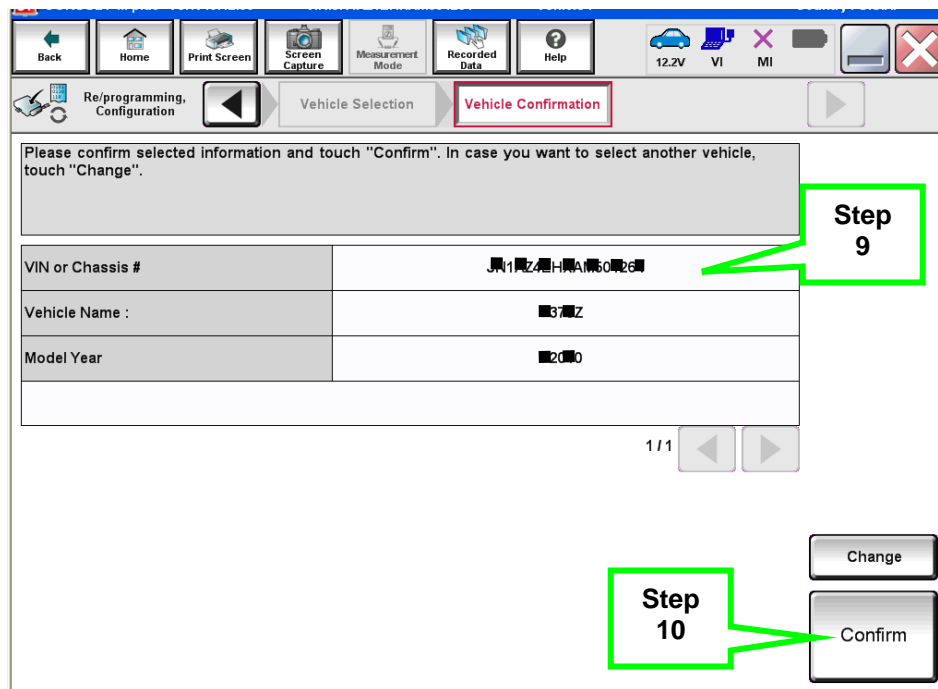

Figure 1i

11. Wait for a few seconds while the progress bar completes.

12. The C11 Odometer Calibration Tool will launch automatically (Figure 1j)

13. The VIN will automatically display.

- **Make sure the displayed VIN matches the vehicle's VIN.**

14. Enter the Technician Name (use the CONSULT PC keyboard).

15. Select **Start**.

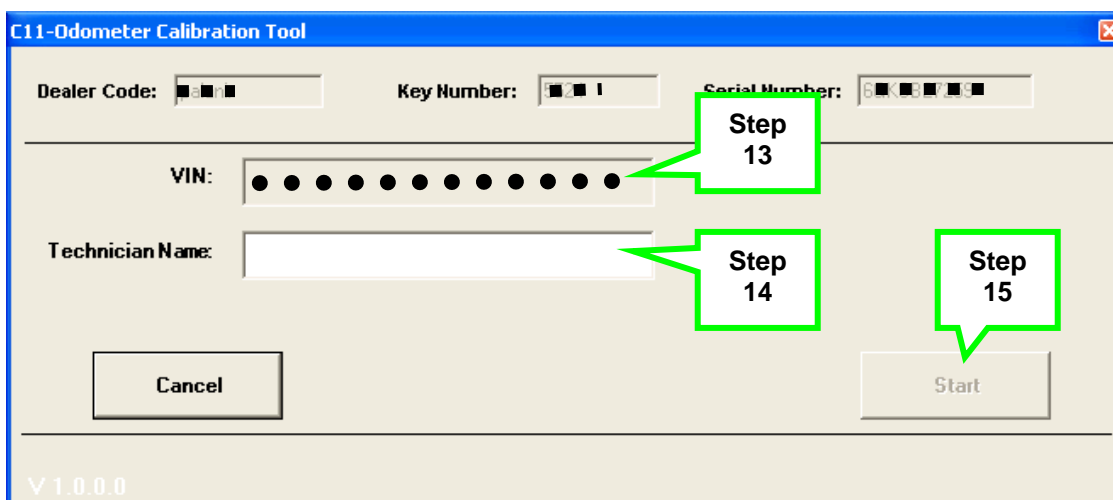

Figure 1j

## 16. Select I Agree.

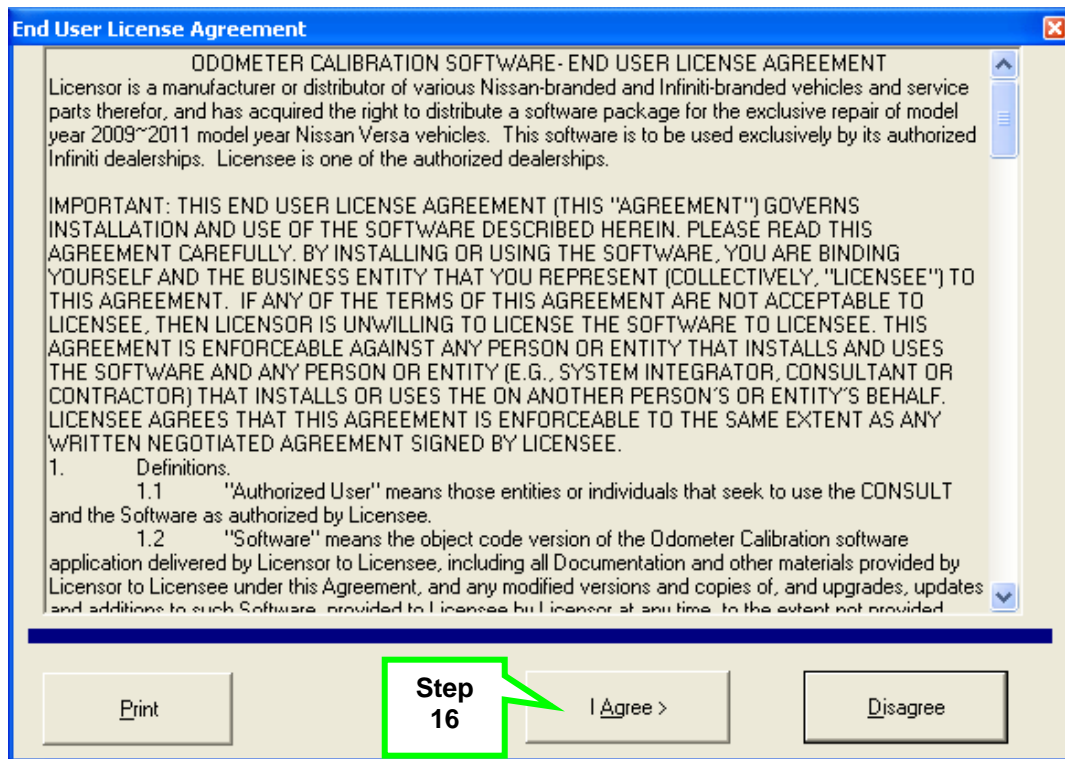

Figure 1k

- After selecting "I Agree" the reprogramming / calibration process will begin automatically and take only a few seconds to complete.

**If the calibration process does not complete within 1 minute, or an error message is displayed:**

- Turn the ignition OFF.**
- Turn the CONSULT PC OFF.**
- Make sure all cables and tools are securely connected.
  - Refer to Prepare for Reprogramming, steps 1 -5, starting on page 9.
  - Disconnect and securely reconnect all tools, cables, and connections.
- Make sure the Internet connection is working.
- Go back to page 13, Reprogram the Meter, and restart.

17. When the calibration process has completed successfully, the message in Figure 1L will display.

18. Turn the ignition OFF

19. Select **Continue**.

20. Wait for 2 minutes.

- The screen in Figure 1m will display with a 2 minute countdown.

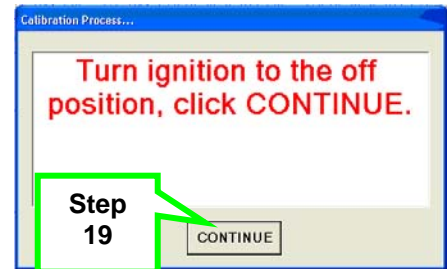

Figure 1L



Figure 1m

21. After waiting 2 minutes, the “Calibration Completion Report” will display (Figure 1n).

22. Print the “Calibration Completion Report” and attach it to the repair order for warranty documentation.

23. Select Exit.

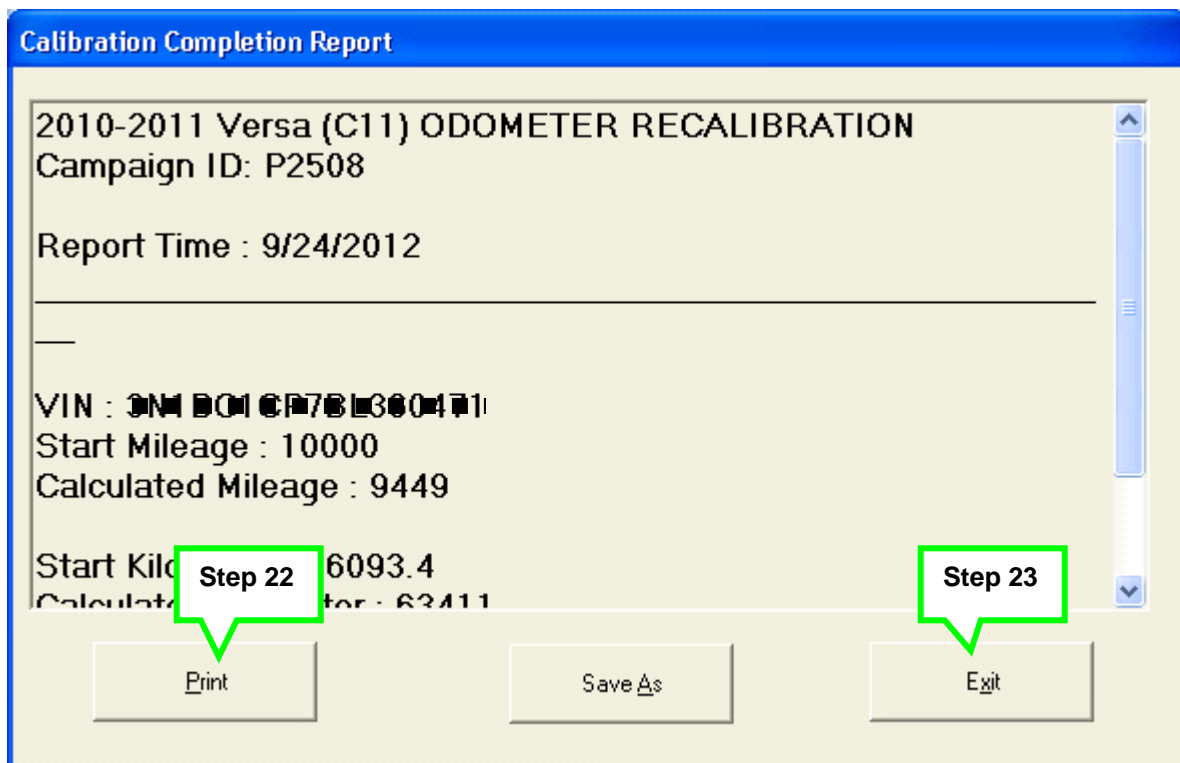

Figure 1n

## Wrap Up (Complete the Procedure)

1. Close the software: C-III plus, C11 Odometer Calibration Tool, and ASIST.
2. Disconnect the combination meter from the meter Reprogramming Tool.
3. Disconnect the reprogramming meter cable from the vehicle.
4. Disconnect the Reprogramming Tool from the CONSULT PC.
5. Reinstall the combination meter in reverse of removal.  
**CAUTION:** Be careful; do not scratch the clear meter lens.
6. Turn the ignition ON.
7. Make sure the mileage on the odometer matches the Calibrated Mileage on the Calibration Completion Report (see example previous page – Figure 1n).
8. Clear DTCs that stored during the meter reprogramming.
  - a. Confirm the VI is still connected to the vehicle's DLC.
  - b. Open/launch C-III plus.
  - c. Wait for the plus VI to be recognized.
    - Serial number will display when the plus VI is recognized.

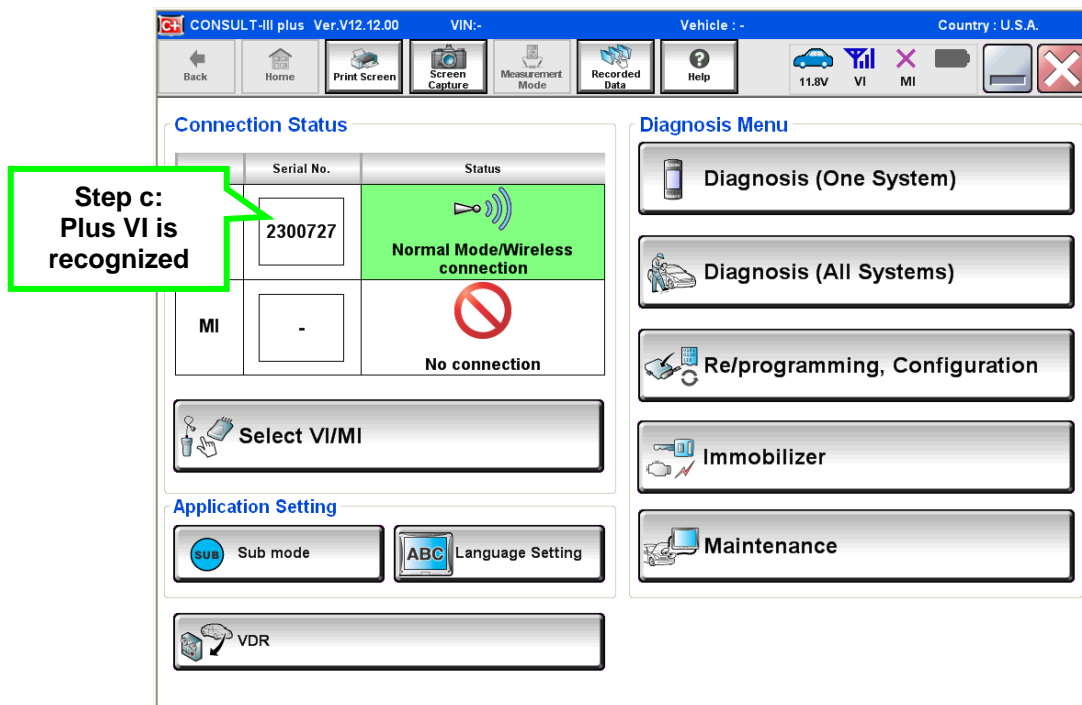

Figure 2a

d. Select Diagnosis (All Systems).

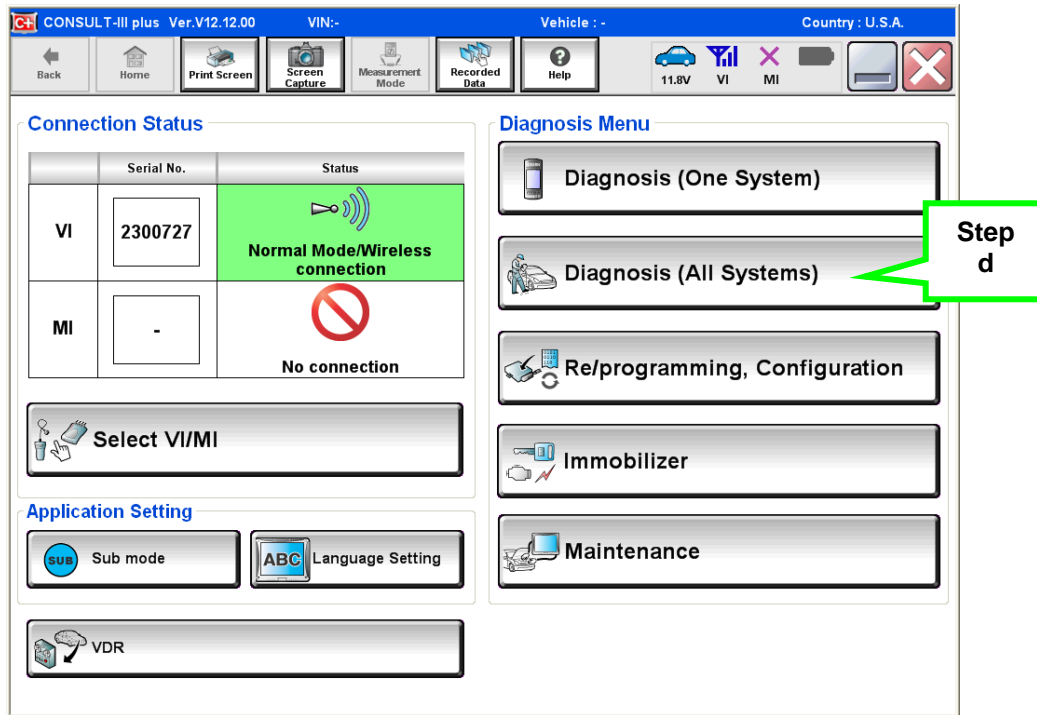

Figure 2b

e. Make sure **VIN or Chassis #** matches the vehicle's VIN.

f. Select **Confirm**.

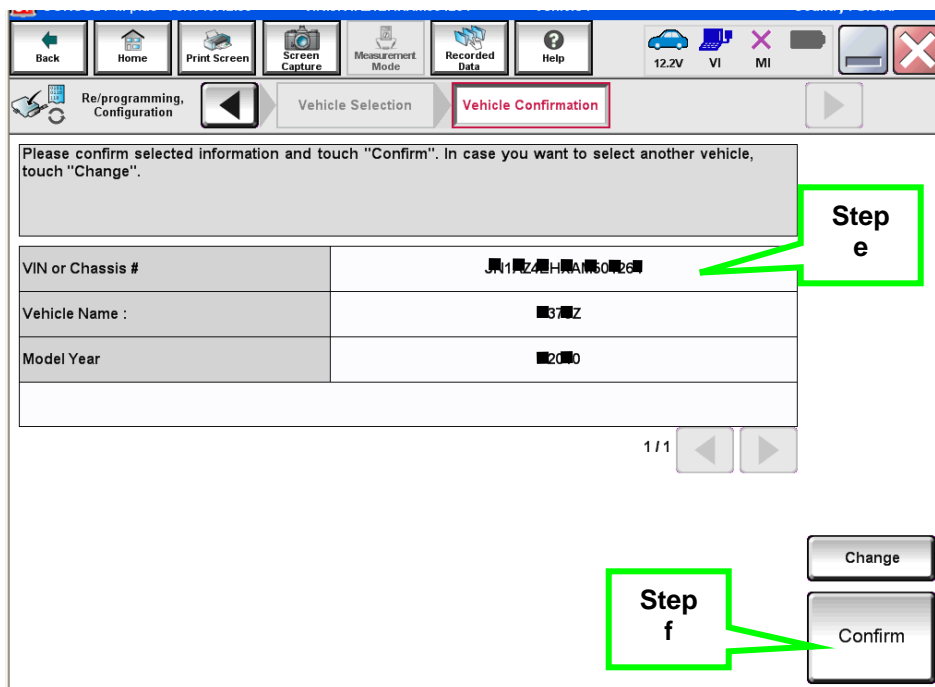

Figure 2c

g. Wait for System Call to complete.

h. Select **Erase**.

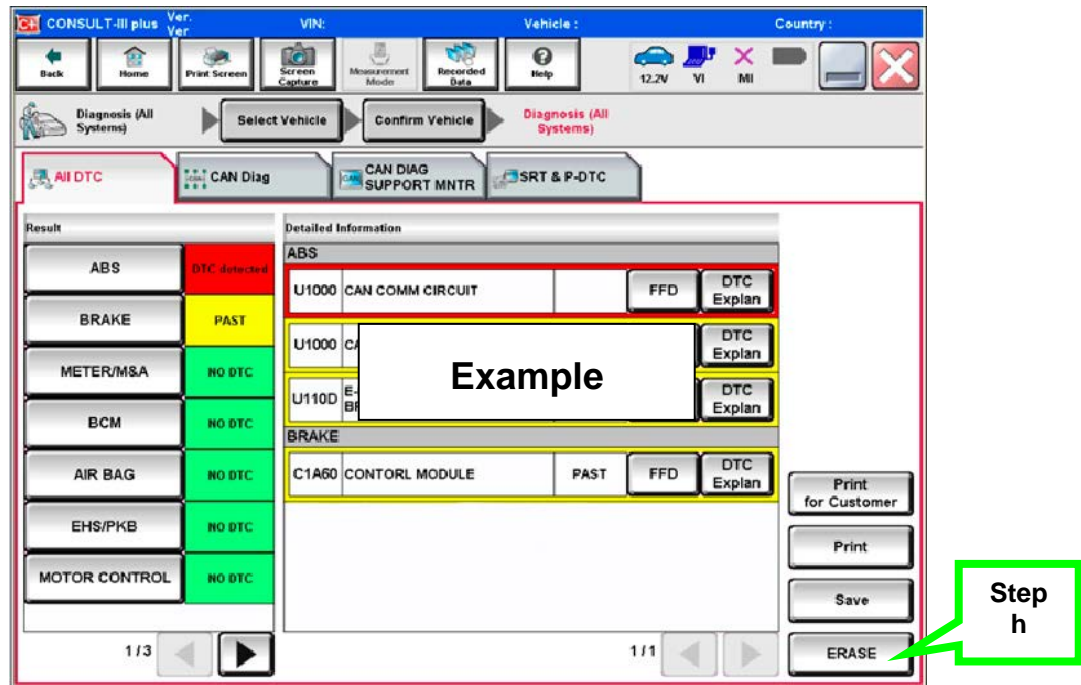

Figure 2d

9. Close C-III plus.

10. Turn OFF the CONSULT PC.

11. Disconnect the VI.

12. Turn the ignition OFF.

13. Disconnect the battery charger from the vehicle battery.

**END**

## CLAIMS INFORMATION

Submit a Campaign (CM) line claim using the following claims coding:

CAMPAIGN (CM) I.D. #	DESCRIPTION	OP CODE	FRT
P2508 *	Reprogram Speedometer and Correct Odometer	P25080	0.6 hrs.

**\* Be sure that you input the updated mileage in your Dealer Management System (DMS) on the claim prior to the claim being submitted. Failure to do so may cause subsequent claims to suspend.**

***The mileage on this claim should reflect the correct and updated mileage after reprogramming is complete. This is being done to ensure the NEW CORRECT mileage is on the campaign claim to reduce further suspensions.***

***If additional repairs are to be submitted as Factory Warranty (FW) or Service Contract (SC) they must be claimed on a separate repair order, with calibrated mileage. Although, additional campaign claims may be submitted on the same repair order.***



## OWNER'S LETTER

Dear Versa Owner:

Nissan is committed to providing the highest levels of product quality and customer satisfaction. We believe that our current and future success depends on your continued satisfaction with Nissan. With that in mind, we want to bring to your attention important information regarding your Nissan Versa Sedan.

### REASON FOR SERVICE CAMPAIGN

Nissan has identified a parts application error relating to an electronic module that is part of the speedometer and odometer in certain 2009–2011 Nissan Versa base and 1.8S vehicles. The error will cause the speedometer to slightly overstate the vehicle's speed and may cause the odometer to slightly over-accrue vehicle mileage. This is not a safety issue, and the vehicle still meets and/or exceeds all applicable safety standards.

### WHAT NISSAN WILL DO

To assure your continued satisfaction and confidence in your vehicle, your Nissan dealer will reprogram the electronic module on all affected vehicles so that it displays vehicle speed and accrues vehicle mileage as designed, and will further adjust the odometer reading to the mileage it would have displayed had it not been for the error at no charge to you for parts or labor. In addition to correcting this inadvertent error, Nissan will stand behind its customers to ensure they are not disadvantaged by this error. Nissan will provide reimbursement of documented costs incurred for any repairs that should have been covered under warranty or for excess mileage charges on lease vehicle returns that resulted from this error.

### WHAT YOU SHOULD DO

Nissan encourages you to contact your Nissan dealer at your earliest convenience in order to arrange an appointment. The service should take about two hours to complete, but your Nissan dealer may require your vehicle for a longer period of time based upon their work schedule. To ensure the least inconvenience for you, it is important that you have an appointment before bringing your vehicle to the Nissan dealer for service. Please bring this notice with you when you keep your service appointment. Instructions have been sent to your Nissan dealer. In the meantime, because the speedometer displays a speed that is higher than it should, you should continue to rely upon the displayed speed as correct and do not attempt to compensate in any manner for the parts application error referenced above.

In addition, please contact Nissan Consumer Affairs at **1-800-Nissan1 (1-800-647-7261)** for instructions on possible reimbursement for related charges if you fall into one of the below categories:

1. You paid for repairs that would otherwise have been covered by the New Vehicle Limited Warranty, but your vehicle's mileage exceeded the mileage limit under the warranty due to the parts application error.
2. You have returned a lease vehicle and paid an amount for excess mileage charges.

If the dealer fails, or is unable to complete the service free of charge, you may contact the National Consumer Affairs Department, Nissan North America, Inc., P.O. Box 685003, Franklin, TN 37068-5003. The toll free number is 1-800-NISSAN1 (1-800-647-7261).

Thank you for providing us an opportunity to ensure on-going satisfaction with your Nissan vehicle.