 HYUNDAI NEW THINKING. NEW POSSIBILITIES. Technical Service Bulletin	GROUP CAMPAIGN	NUMBER 14-01-018
	DATE MAY 2014	MODEL(S) Tucson (JM)

SUBJECT: FRONT AND REAR UNDER BODY
CORROSION PREVENTION TREATMENT
SERVICE CAMPAIGN TT2

*** IMPORTANT**

***** RETAIL VEHICLES ONLY *****

Dealers must perform this Service Campaign whenever an affected vehicle is in the shop for any maintenance or repair.

When a vehicle arrives at the Service Department, access Hyundai Motor America's "Warranty Vehicle Information" screen via WEBDCS to identify open Campaigns.

Description: This bulletin provides a preventative procedure to apply cavity wax and undercoating to the front and rear under body.



APPLICABLE VEHICLES:

VERIFY THAT THE VEHICLE IS IDENTIFIED AS AFFECTED BY THE SERVICE CAMPAIGN VIA WEBDCS.

1. **Model:** Tucson (JM) 2005 – 2009 Model Years
2. **Production Date Range:** From AUG. 10, 2004 to OCT. 10, 2009
3. **Areas:** Connecticut, Delaware, Illinois, Indiana, Iowa, Maine, Maryland, Massachusetts, Michigan, Minnesota, Missouri, New Hampshire, New Jersey, New York, Ohio, Pennsylvania, Rhode Island, Vermont, West Virginia, Wisconsin, and the District of Columbia

★ IMPORTANT

There are circumstances under which vehicles not currently or never registered in the “salt belt” states listed may be eligible for this service campaign. For example: vehicles that have relocated into a “salt belt” area and/or vehicles registered in a “non-salt belt” state and driven in a “salt belt” area. If it is determined that an owner of a vehicle within the affected VIN production date range relocates or has operated their vehicle in a “salt belt” area, the dealer should perform the campaign procedure. The dealer should perform this procedure at no cost to the customer, and the dealer’s District Parts and Service Manager must be contacted prior to repair and submission of Warranty Claim.

★ NOTE

If the owner of a vehicle within the affected VIN production date range requests an undercarriage inspection of their vehicle, the inspection should be performed at no charge to the customer.

PARTS INFORMATION:

PART IMAGE	PART NUMBER	DESCRIPTION
	00232-19034	Cavity Wax 1/2 bottle is required per vehicle.
	00232-19035	Black Undercoating (non-rubberized type) 2 cans required per vehicle.

TOOLS AND EQUIPMENT (DEALER'S RESPONSIBILITY):

WAX SPRAY GUN P/N: 00232-19036	HAMMER – 16oz	AIR NOZZLE	WIRE BRUSH	GOGGLES & RESPIRATORY PROTECTION
				
PLASTIC BAGS				

*** NOTE**

- Use the wax spray gun and nozzle provided in TSB 13-01-039 (Campaign 113).
- Set the air compressor pressure regulator to 70 psi before using the wax spray gun.

CAUTION

Wear protective goggles and respiratory protection when performing the procedures in this bulletin. The vehicle should be in a well-ventilated area.

WARRANTY INFORMATION:

OP CODE	OPERATION	OP TIME
40C010R0	APPLY CAVITY WAX AND UNDER COATING TO UNDER BODY	0.7 M/H

NOTE 1: Submit Claim on Campaign Claim Entry Screen.

NOTE 2: Each labor operation will reimburse applicable undercoating and cavity wax in sublet.

NOTE 3: If a part is found in need of replacement while performing Service Campaign TT2, please submit a separate claim using the same Repair Order used for the Service Campaign.

SERVICE PROCEDURE:

1. Lift the vehicle on a hoist. Remove the engine under cover (A) referring to the workshop manual.

CAUTION

Wear protective goggles and respiratory protection when performing the procedures in this bulletin. The vehicle should be in a well-ventilated area.

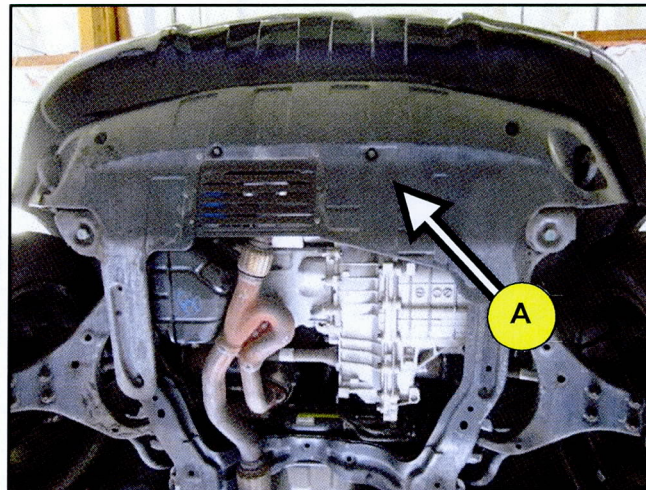

2. Using a 16 oz. hammer, lightly tap on and around the areas marked with a red dot, to remove loose debris and the PVC coating. Refer to the photos on the right.

Front crossmember (B) and front lower arms (C).

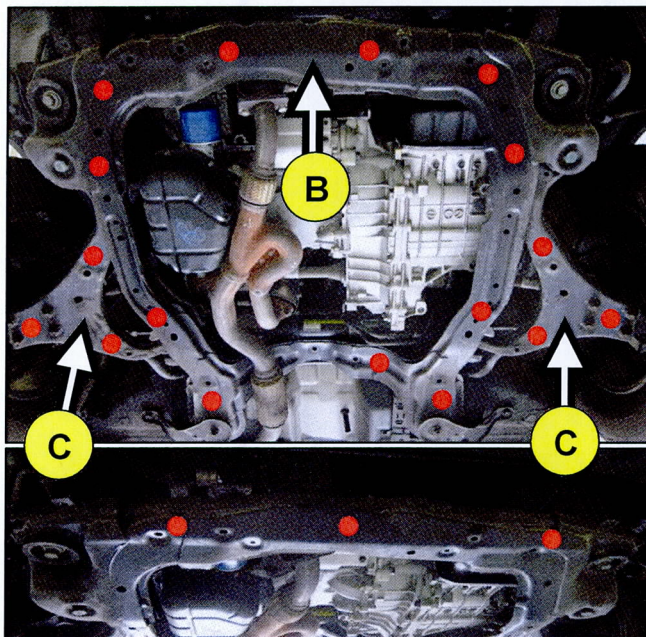

SUBJECT: FRONT AND REAR UNDER BODY CORROSION PREVENTION TREATMENT

Rear crossmember (D), left and right suspension arms (E), and left and right trailing arms (F).

*** NOTE**

Rear components will differ between 2WD and AWD. Refer to the illustrations on the following pages.

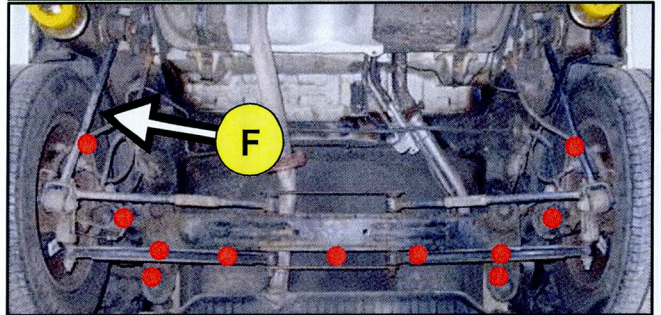
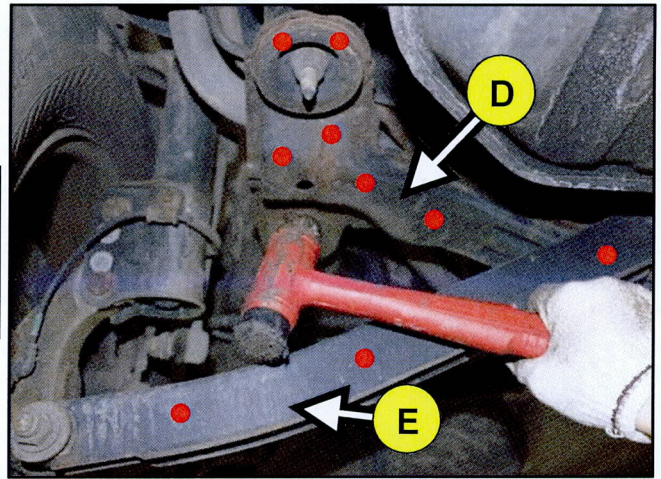

2WD rear crossmember (G), suspension arms (H), trailing arms (I), and brackets (J).

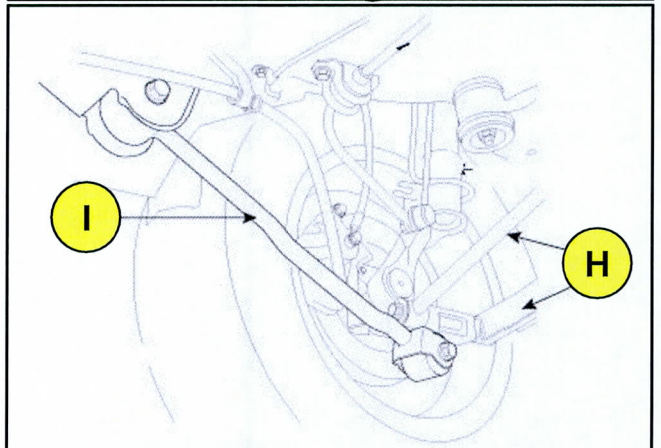
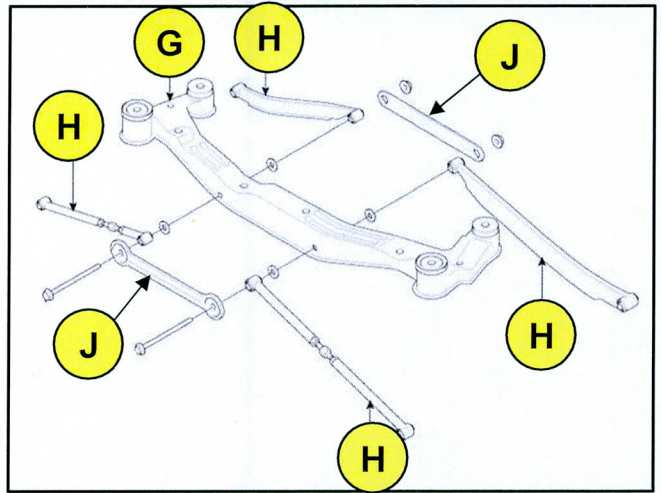

AWD rear crossmember (J), suspension arms (K), and rear trailing arms (L).

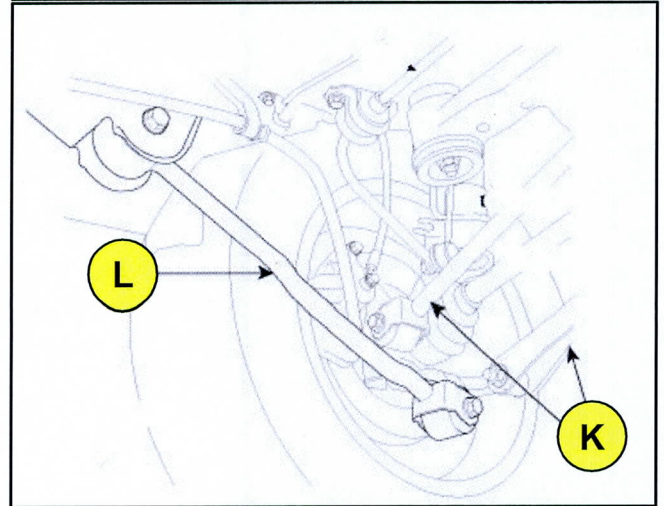
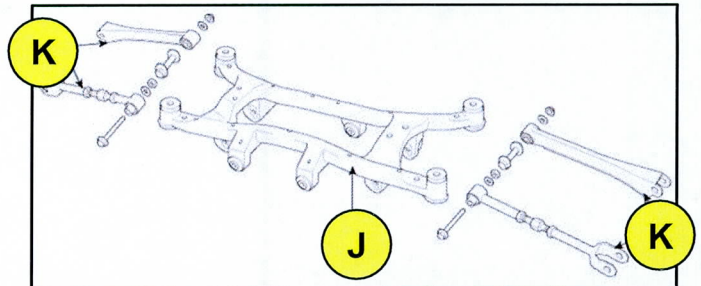

3. Use a wire brush or clean rag to remove debris from the front and rear crossmembers, front lower arms, rear suspension arms, rear trailing arms, brackets, and fuel tank.

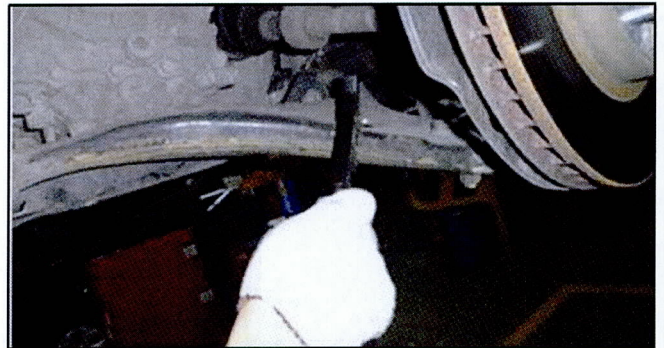

4. Remove the remaining debris in the components by inserting an air gun into the circled holes. Blow the air in multiple directions to remove as much debris as possible. Refer to the photos on the right.

Repeat this step two to three times to remove the remaining debris from inside the components.

Left and right front lower arms.

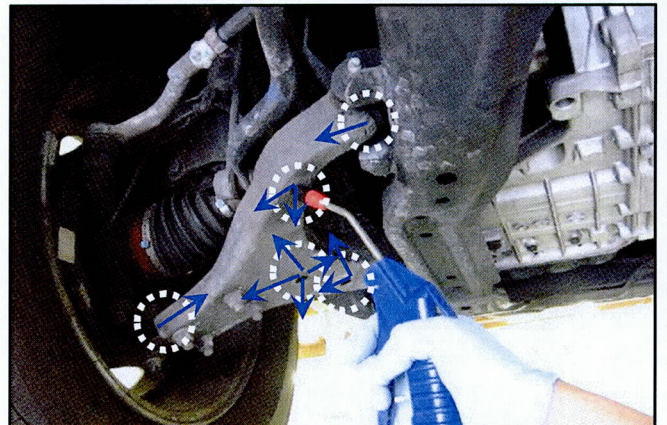

Rear crossmember.

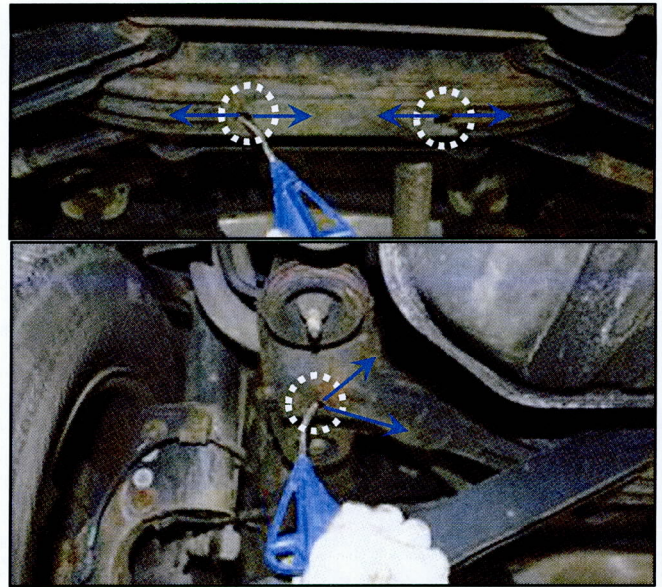

Exterior of left and right rear suspension, left and right trailing arms, and brackets.

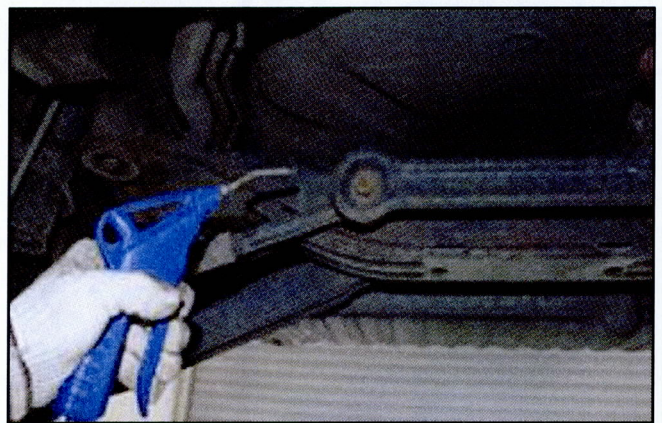

Top, bottom and sides of the fuel tank (M).

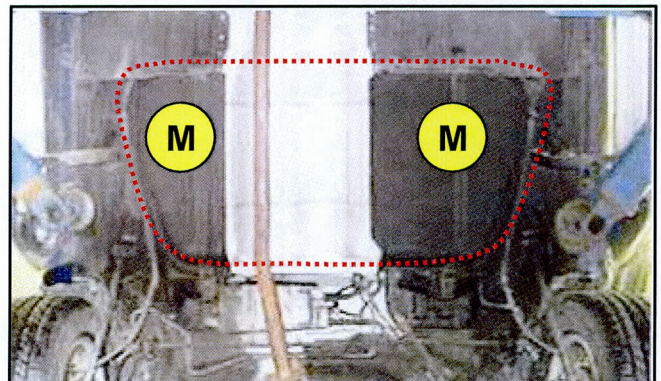

5. Wrap plastic bags around all tire/wheel/brake assemblies and exhaust tubing to protect it from overspray.

*** NOTE**

Exhaust tubing must be sufficiently cooled before it is wrapped.

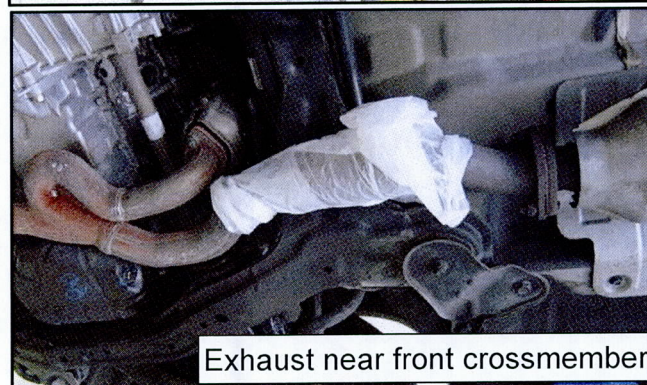
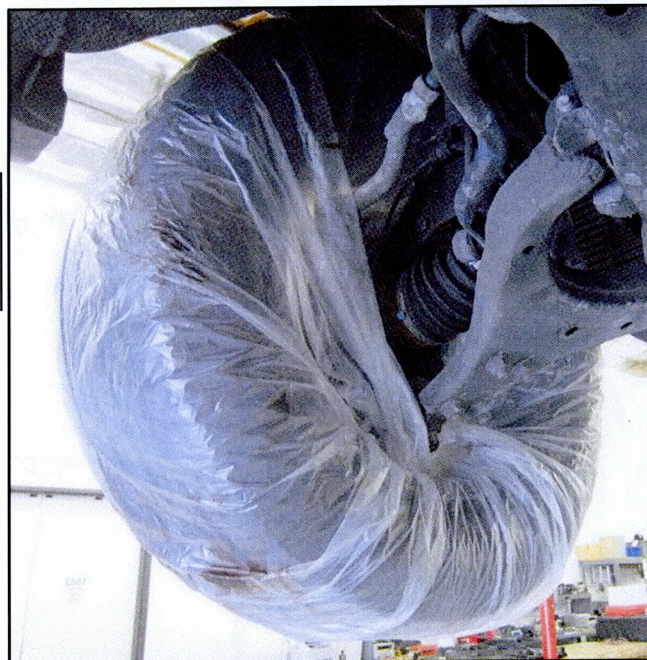
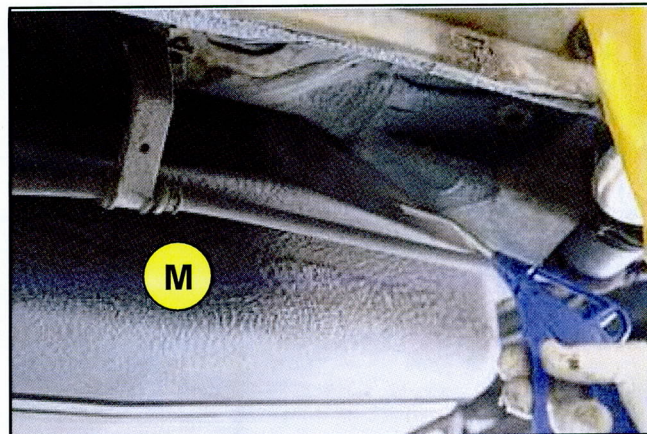

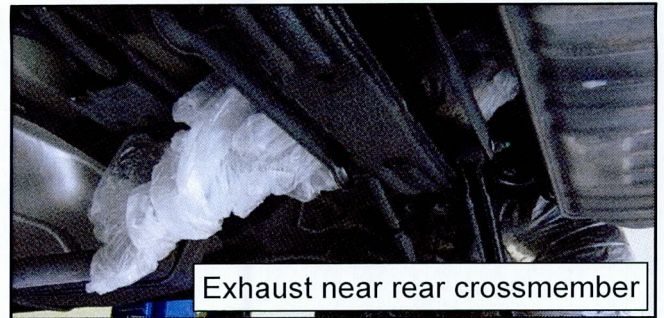

- 6. Select the nozzle shown to the right to spray the interior of the lower arm.

*** NOTE**

Supply air pressure must be set to 70 PSI.

CAUTION

Wear protective goggles and respiratory protection when performing the procedures in this bulletin. The vehicle should be in a well-ventilated area.

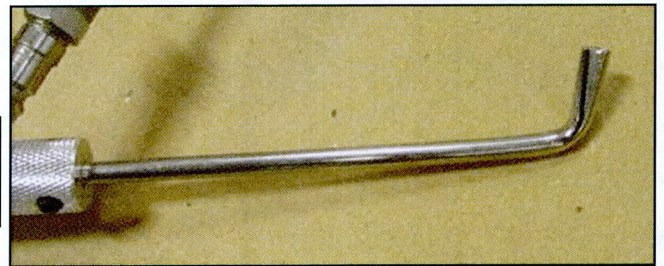

When spraying the wax, a light mist should be visible. If no mist is seen, point the nozzle in a safe direction, and press the gun's trigger until a mist is visible.

- 7. Spray cavity wax through the marked holes into the inside of the rear crossmember, front lower arms, Spray in multiple directions to coat the interior surface. Refer to the photos on the right.

Left and right front lower arms.

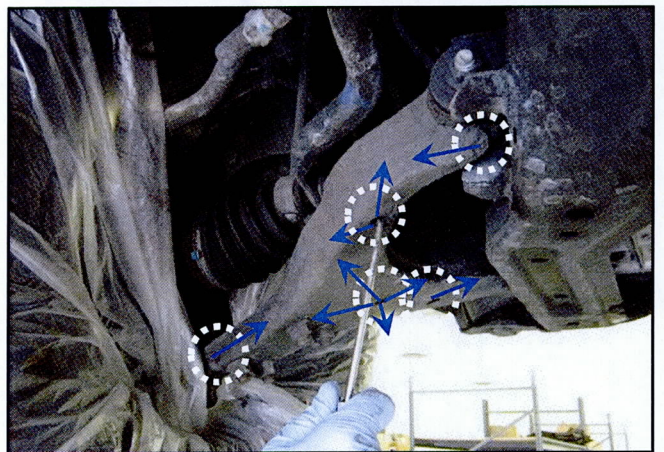

Rear crossmember

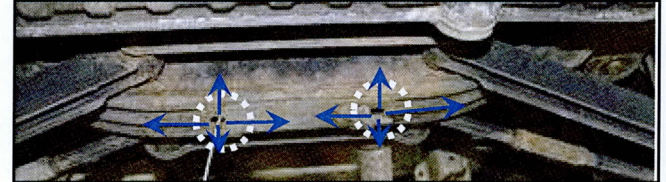
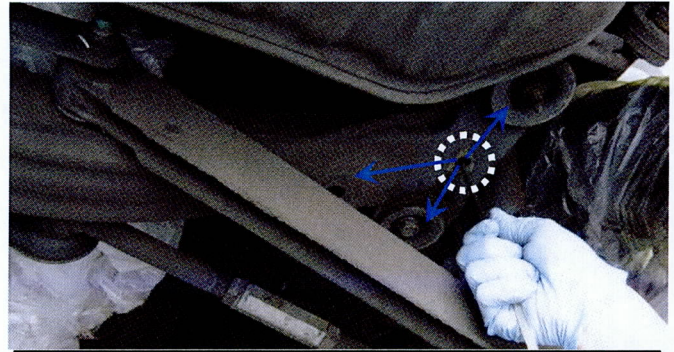

- 8. Wipe off the excess wax that may have flowed out.

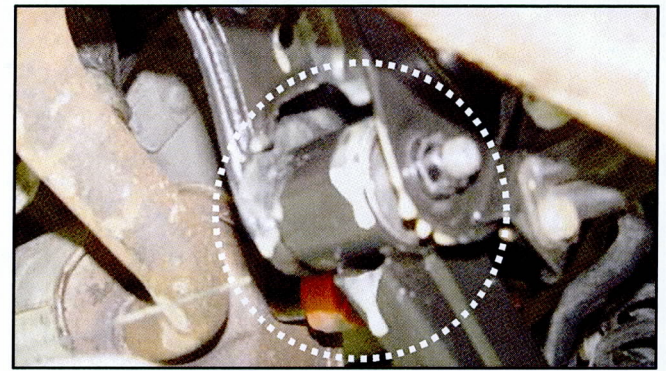

- 9. Spray the black undercoating on all exterior surfaces of the front and rear crossmembers, front lower arms, and rear suspension and trailing arms, brackets, and fuel tank. Refer to the photos on the right.

Front crossmember.

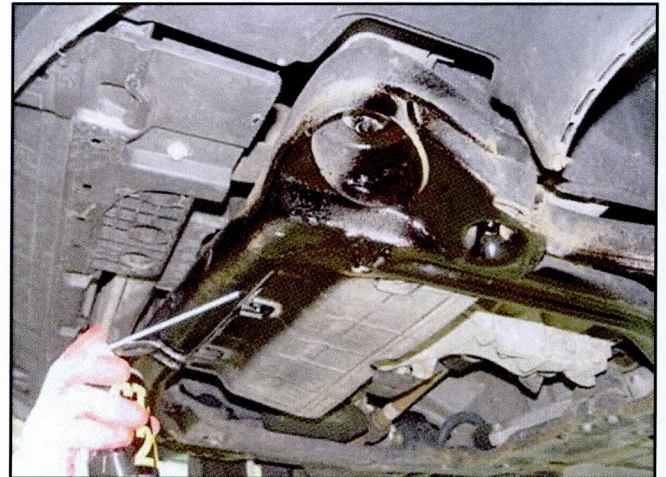

Left and right front lower arms.



Rear crossmember, left and right rear suspension, left and right trailing arms, and brackets.

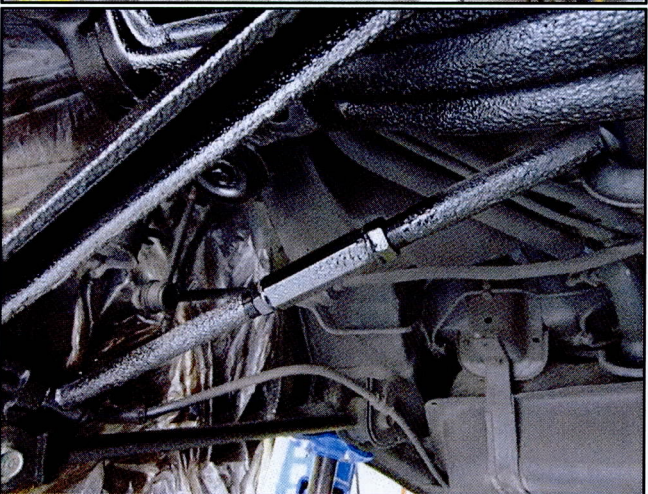

Fuel tank.

*** NOTE**

Spray undercoating on all exposed areas of the fuel tank, including the top half.

Avoid spraying the exhaust tube (N).

