



Service Bulletin

File in Section: 08 - Body and Accessories

Bulletin No.: 15-08-44-001H

Date: June, 2016

INFORMATION

Subject: GM of Canada OnStar® Cellular Communication Upgrade

Models: 2000-2014 GM Passenger Cars and Light Duty Trucks
2015 Buick Enclave
2015 Cadillac Escalade Models (Built W/O VV4)
2015 Chevrolet Camaro, Express, Traverse
2015 Chevrolet Silverado 2500/3500, Suburban, Tahoe (Built W/O VV4)
2012 Chevrolet Colorado
2015 GMC Acadia, Savana
2015 GMC Sierra 2500/3500, Yukon Models (Built W/O VV4)
2012 GMC Canyon
2005-2010 Pontiac Vibe
Equipped with OnStar® (RPO UE1)

Attention: This Bulletin does not apply to vehicles equipped with RPO UE0.

This Bulletin has been revised to add Software issues related to this bulletin section. Please discard Corporate Bulletin Number 15-08-44-001G.

Canadian Upgrade Program Overview

Canadian wireless service providers plan to decommission their 2G Code Division Multiple Access (CDMA) network through 2015. OnStar® currently depends on active and functioning 2G CDMA networks to deliver services. As a result, in order to continue to provide OnStar® services without interruption, Canadian vehicles that do not have OnStar® 3G/4G LTE will need a hardware upgrade.

In order to upgrade their vehicle hardware and continue receiving OnStar® services, a customer will receive a letter from OnStar® with instructions for the upgrade process when the hardware is available for installation on their vehicle. There are different versions of hardware required for vehicles that will be available at different times in early 2015, so it is important that customers first receive the communication from OnStar® to begin the upgrade process.

Note: Refer to PI1533 for additional repair instructions that may be required for select models to ensure proper handsfree voice recognition performance.

Notice: Canadian OnStar® equipped vehicles travelling into the United States are to be serviced as would any U.S. vehicle while visiting, or relocating, to the United States. Follow normal diagnostic and repair procedures to support customer satisfaction regardless of vehicle point of origin.

Software Calibrations within the Procedures Below that MUST be Completed before Proceeding with this Bulletin:

Volt and ELR

- 2011-2014 Chevrolet Volt and 2014 Cadillac ELR – #PIC5920: Vehicle Will Not Charge And Hybrid Loss Of Isolation With DTC P0AA6

Note: 2011-2014 Chevrolet Volt and 2014 Cadillac ELR — the HPCM2 and BECM **Must Be** updated with the latest calibrations available on TIS2WEB prior to proceeding with OnStar® cellular communication upgrade. Use the unique labor operation in the #PIC5920.

- 2011-2012 Chevrolet Volt – #11342E: Customer Satisfaction - Enhancements for Side Impact Pole Performance

All Vehicles with Radio RPOs IO3, IO4, IO5, IO6, or (RAO – UA3)

- 2013-2015 Vehicles with radio RPOs IO3, IO4, IO5, IO6, or (RAO – UA3) (ATS Base Radio) – use latest version of PI1238: No XM on Start-Up when Manually Tuned and/or Using Voice Recognition, No Radio Wake-Up

Note: 2013-2015 Vehicles with radio RPO's IO3, IO4, IO5, IO6, or (RAO-UA3) (ATS Base Radio) Ensure that the radio has the latest calibration available on TIS2WEB prior to proceeding with the OnStar® cellular

communication upgrade. As stated in this PI, the "Audio Soft Version" label should be 000474 or lower before continuing. If version 000477 is already installed, reprogramming is not necessary. DO NOT reprogram. Software corruption may occur. Use the unique labor operation in the #PI1238.

Please Be Sure To Read These Important Guidelines:

- The customer must accept OnStar's "User Terms, Privacy Statement and Software Terms" in order to get the hardware upgrade. The customer can provide their acceptance at www.onstar.ca by logging into their OnStar® account.
- After accepting the OnStar® User Terms and Conditions the customer will need to call the OnStar® call center to begin the ordering process. English/French: 1-877-935-8717
- Some customers will be required to purchase a 1-year, non-refundable OnStar® Service Plan at the regular retail price (no discounts are available):
 - ⇒ 1-year OnStar Protection Plan: \$249.90 + tax
 - ⇒ 1-year OnStar Security Plan: \$299.90 + tax
 - ⇒ 1-year OnStar Guidance Plan: \$399.90 + tax
- The 1-year OnStar® Service Plan is non-refundable or transferable to another person. Upgrades can apply unused subscription months to a new or Certified Pre-Owned OnStar® equipped GM vehicle purchase or lease prior to the expiration date.
- Hardware will be ordered and shipped to the customers selected dealer for installation.
- Hardware upgrade sets are VIN specific and must be installed on the vehicle that the set was ordered for.
- Actual odometer reading must be used on the Repair Order (RO).

Note: DO NOT estimate the odometer reading of the vehicle.

- Customers will receive a new Hands-Free Calling number once the new hardware is installed and configured.
- Any nametags that were stored in the old system will need to be reset by the subscriber once the new hardware is installed.
- Customers are responsible for the charges described in the communication from OnStar® regardless of whether their vehicle is in or out of the New Vehicle Warranty period. In addition, customer should not be charged labor costs. Dealers can charge GM the labor for the upgrade as specified at the end of this bulletin used the listed labor operation.
- All GM vehicles built in 2000 and after, and that are equipped with digital hardware, are eligible for an OnStar® hardware upgrade.

Aftermarket Equipment Installed

Prior to starting the upgrade the technician should inspect the radio to verify that the GM original equipment radio is present and functioning. If an aftermarket radio, navigation, amplifier, or bluetooth has been hard-wired into the vehicle, ensure that the Service Advisor is aware and the customer has approved to go ahead with the upgrade given the risk that their aftermarket accessory and/or OnStar® might not work after the upgrade has been completed.

Note: The following statement was presented to the customer in their original offer communication.

"Vehicles equipped with hard-wired aftermarket electronic equipment, such as radios, receivers, navigation systems, amplifiers and bluetooth systems may not be compatible with the upgraded OnStar hardware. If this type of equipment is installed in your vehicle and you choose to upgrade your OnStar hardware, your OnStar® system and the aftermarket equipment may not operate after the upgrade, and you will be responsible for any extra costs associated with upgrading the vehicle's OnStar® hardware, including any costs to reverse the installation."

Part Ordering Process – Active OnStar® Subscribers

To upgrade their vehicle to an OnStar® 4GLTE (Generation 10) or 3G (Generation 9.4) system, the customer must do the following:

1. Currently have an active OnStar® service plan.
2. Have received an upgrade communication letter from OnStar®.

Note: OnStar® will communicate to subscribers when their specific hardware is available. Not all hardware types will be available at the start of the program.

3. Go to the website www.onstar.ca and sign into their OnStar® Account to accept OnStar's "User Terms, Privacy Statement and Software Terms."
4. Contact OnStar® to initiate the hardware order:
 - "User Terms, Privacy Statement and Software Terms" must be accepted prior to ordering hardware.
 - English/French 1-877-935-8717
5. Purchase a one year (annual) service plan (as required) on the OnStar® website or through the OnStar® Advisor.
 - Service Plan is non-refundable, when required.
 - Current Basic Plan, 2014 Remotelink Key Fob Service, and Factory Trail Service customers may not require a commitment.
 - Unused portions of the annual package is transferable to a new OnStar® 4G LTE equipped vehicle.
6. Wait for selected Dealer to schedule an appointment with the customer.

Take the vehicle to the dealership on the appointment date for the hardware installation and activation.

Part Ordering Process and Hardware Installation – New Unsold Vehicles on Dealers Lot

1. Dealers will automatically receive OnStar® hardware upgrade kits for affected dealer new vehicle inventory beginning spring 2015.

Note: Not all upgrade modules will be available at program launch, modules will be release for dealer inventory when they are available. Upgrade kits are VIN specific, installing a kit in another vehicle will cause configuration issues and might result in damaging the module.

2. Dealer will be provided a summary by e-mail of the parts being shipped (FEDEX) to their dealership from York Electronics.

Note: On reviewing the list, if the vehicle is no longer in the dealer inventory (either due to sale or dealer trade) contact York by phone, e-mail, or fax to get a Return Material Authorization. Parts should not be forwarded to the dealer or installed in the customer's vehicle.

York Contact Information:

Eastern Canada

Phone: English 1-888-650-9675 ext. 307

Phone: French 1-888-650-9675 ext. 302

Fax: 1-888-650-9677

E-mail: info@yorkelec.com

Western Canada

Phone: 1-800-361-2894 ext. 1

Fax: 1-800-361-5396

E-mail: info@yorkelec.com

3. Technician will install parts, program the module using Service Programming System (SPS) available on TIS2WEB and confirm connection.
 - Service Technician will follow the installation instructions below.
4. If successful, the technician will simply verify activation is complete.

Upon confirmation of successful hardware installation, apply the OnStar® 4G Wi-Fi sticker to the vehicle near the price and fuel economy label, the vehicle is ready for sale.

Note: These vehicles will not behave exactly like those with factory installed modules. The OnStar® activation message will begin to play once the vehicle is driven 1.6 km (1 mile) and will play at each key cycle until the vehicle is sold and the customer has accepted the OnStar® User Terms, Privacy Statement and Software Terms. For some vehicles the OnStar® icon on the radio display screen will be grayed out and inactive after the upgrade. This icon becomes active once an active OnStar® account is added to the vehicle. It is important to note that the Wi-Fi feature will be active and can be used in demonstrations.

Customer Hardware Upgrade

To complete the hardware upgrade for a customer's vehicle to an OnStar® 4G LTE (Generation 10) or 3G (Generation 9.4) system, the dealership will complete following below:

1. Direct all customer questions to OnStar®.
 - If the customer has received the upgrade letter and they have additional questions, they can call OnStar® at 1-877-935-8717 (English/French) or by pressing their blue button.
2. Dealers will be notified daily by e-mail of orders placed for their dealership with related customer contact information.
3. Dealers will contact the customer to schedule an appointment.
 - Technician will verify VIN and customer information on Kit with VIN of installation vehicle (do not install hardware if VIN does not match).

Note: Installing the hardware in the wrong vehicle might damage the hardware.

- Tech will complete installation of hardware.
- Tech will use Service Programming System (SPS) to activate the hardware.
- The upgrade module can only communicate with the GDS 2 diagnostic tool.

Tip: Some 2013 and prior vehicles are supported by the Tech 2 diagnostic scan tools. The Tech 2 is not capable of communicating with the upgraded OnStar® module. GDS 2 must be utilized to perform diagnostics specific to the upgraded OnStar® system on these vehicles.

Note: It is important to correctly complete the following step in order to avoid manual configuration.

4. The technician will push the OnStar® Blue Button to confirm successful activation.
5. Upon confirmation of successful activation, the vehicle is ready for customer pick up.

Software issues related to this bulletin:

Issue #1

Issue Description:

After Gen 9.4 CDMA EOL Upgrade the vehicle will not be capable of a door lock/unlock from an OnStar Advisor. Unlock service for the customer will be provided with Roadside Assistance, which is included in all paid OnStar Service Plans. There is no impact to customer key FOB functionality.

Cause:

The vehicle requires discrete signal to operate the door locks. This functionality was not turned on in the design of the hardware and cannot be fixed.

Customer Questions:

If the customer has further questions or concerns about the loss of the door lock/unlock functionality, they may call the OnStar CDMA End Of Life (EOL) Team at 877-935-8717.

Impacted Vehicles

- 2003-2005 Buick Terraza
- 2003-2005 Chevrolet Venture
- 2003-2005 Oldsmobile Silhouette
- 2003-2005 Pontiac Montana

Impacted Vehicle Table

Year	Make	Model
2003	Chevrolet	Venture
2003	Chevrolet	Venture AWD
2003	Oldsmobile	Silhouette
2003	Oldsmobile	Silhouette AWD
2003	Pontiac	Montana
2003	Pontiac	Montana AWD
2004	Chevrolet	Venture
2004	Oldsmobile	Silhouette
2004	Pontiac	Montana
2005	Buick	Terraza
2005	Chevrolet	Venture
2005	Pontiac	Montana
2005	Pontiac	Montana SV6

Issue #2**Issue Description:**

After CDMA EOL Upgrade the vehicle's Driver Information Center may display a message stating "Phone Not Present." This message cannot be fixed/turned off permanently, but can be cleared on every ignition cycle. There is no impact to OnStar services or vehicle functionality in any way.

Cause:

The vehicle originally used a GM approved cell phone that could plug into the vehicle. That handset has been discontinued, and is thus not present. The functionality to disable the message was not included in the CDMA EOL upgrade programming.

Customer Questions:

If the customer has further questions or concerns about the error message, they may call the OnStar CDMA End Of Life (EOL) Team at 877-935-8717.

Impacted Vehicles

- 2002-2005 Cadillac Seville, Deville and DHS

Impacted Vehicle Table

Year	Make	Model
2002	Cadillac	Deville
2002	Cadillac	Deville DHS
2002	Cadillac	Deville DTS
2002	Cadillac	Seville SLS
2002	Cadillac	Seville STS
2003	Cadillac	Deville
2003	Cadillac	Deville Luxury
2003	Cadillac	Deville Touring
2003	Cadillac	Seville SLS
2003	Cadillac	Seville STS
2004	Cadillac	DHS
2004	Cadillac	Deville
2004	Cadillac	Seville
2005	Cadillac	DHS
2005	Cadillac	Deville

Issue #3**Issue Description:**

After CDMA EOL Upgrade, the vehicle will not receive Engine Oil Life data.

Cause:

The functionality design of the hardware does not support Onstar OVD email oil life data.

Impacted Vehicles

- 2006 Buick Lucerne with 3.8 L26 V6 engine (models CX, CXL and CSX)

Replacement Instructions

For the HUMMER H2 MY 2003-2007 Follow the Instructions Listed Below:

Note: Technician will verify VIN and customer information on Kit with VIN of installation vehicle (do not install hardware if VIN does not match.)

1. To access the OnStar® module, refer to the Service Information (SI) for the appropriate procedure.

Note: After the removal of the original OnStar® module, modification of the new module is required to secure the module into place.

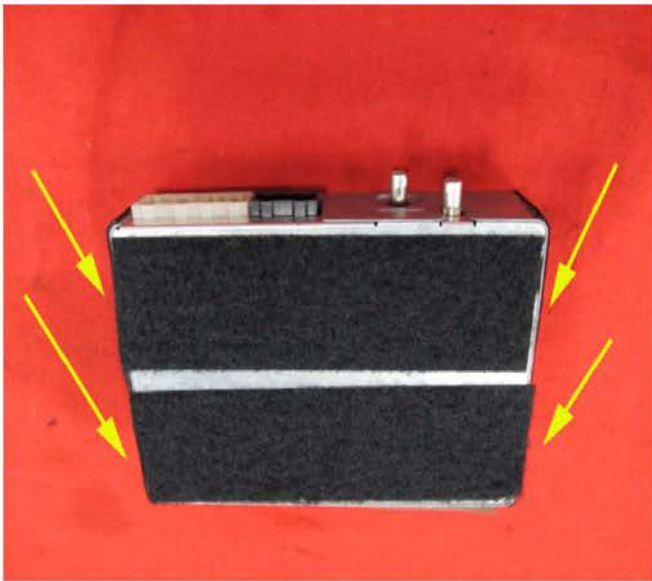

4032379

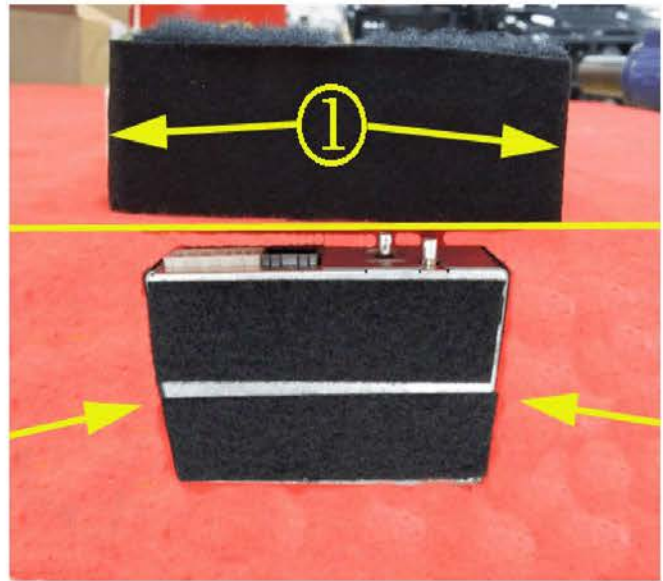

4068796

- Obtain two strips, approximately 177 mm (7 inches) in length, of 2" Velcro® 191195 Reclosable Loop Fastener Tape (hook and loop) or equivalent and apply one side of the tape to the bottom of the module as shown above.

- Cover both sides of the module with BRS Tape KT13487 (1) or equivalent, as shown above.



4032430

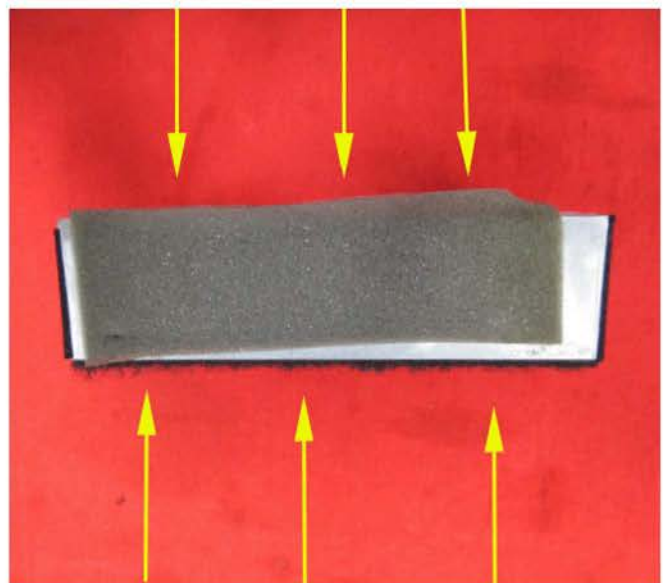

4032567

- In the open space in the instrument panel (I/P), where the original module was, install on the bottom portion of I/P the other side of the 2" Velcro® 191195 Reclosable Loop Fastener Tape (hook and loop) or equivalent as shown above.

- Cover the back of the module with 3M™ 4314 Urethane Foam (½" x 7") or equivalent as shown above.
- Install the female to male cable (P/N 23242476) to the vehicle's GPS antenna cable.
- Install the UHF adaptor cable (P/N 23242478) to the vehicle's cellular (purple) cable.

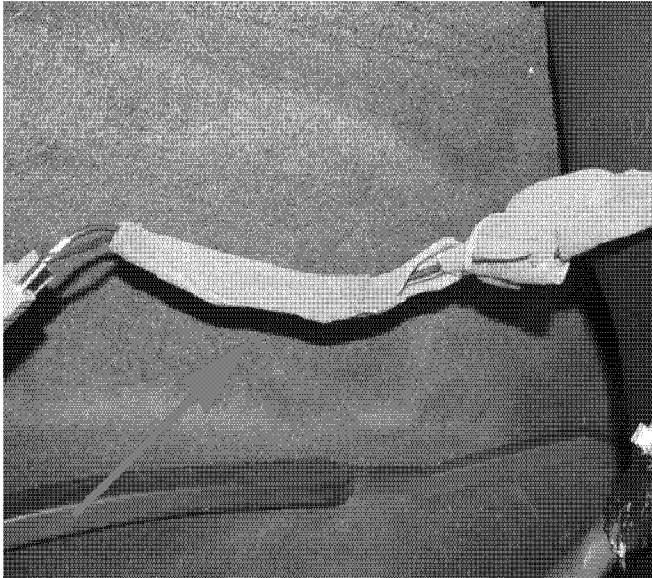

4034965

8. Wrap the female to male cable and the UHF adaptor cable with 3M™ 4314 Urethane Foam Tape or equivalent to eliminate any potential noise as shown above.
9. Transfer the Bluetooth Antenna, if equipped, to the new module.
10. Connect the female to male cable (P/N 23242476) to the module's outboard connector (GPS).
11. Connect the UHF adaptor cable (P/N 23242478) to the module's inboard connector (cellular).

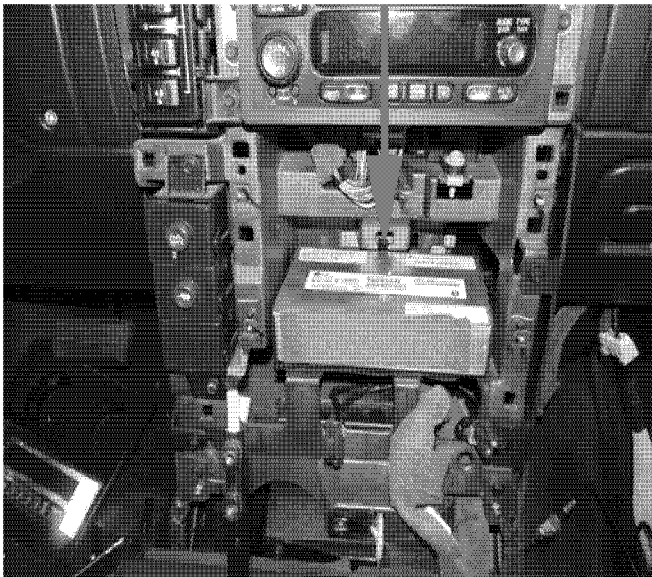

4034924

12. Secure the module to the recently installed Velcro® 191195 Reclosable Loop Fastener Tape (hook and loop) or equivalent inside the I/P as shown above. Ensure to position the cables out of the way of the module while installing.
13. To reassemble the vehicle, refer to the Service Information (SI) for the appropriate procedure.

14. To program the control module, perform the following procedure:

- 14.1. Install EL-49642 SPS programming support tool.

Note: Due to a change in SPS you must select 'Reprogram ECU', for Telematics Communication Interface Control Module Programming from the Selected Programming Process even if the unit is being replaced.

If 'Replace and Program ECU' is selected the Telematics Communication Interface Control Module will not be listed in the Supported Controllers screen. You must go back and select 'Reprogram ECU.'

- 14.2. In the SPS Supported Controllers screen, depending the model year, there will be one of three options that are listed below.

Select the appropriate option for the vehicle:

- Mobile Telephone Communications Interface Control Module (Use ONLY per Bulletin 15-08-44-001)
- Telematics Communication Interface Control Module (Use ONLY per Bulletin 15-08-44-001)
- Vehicle Communication Interface Module (Use ONLY per Bulletin 15-08-44-001)

- 14.3. Follow the on-screen instructions to complete programming.

Note: If there is a programming issue, please contact Techline Customer Support Center (TCSC) at 1-800-828-6860 (1-800-503-3222 for French).

15. Turn the ignition to the OFF position and wait ten minutes.

Notice: A 10 minute wait time is required to avoid configuration errors.

Note: Do **NOT** press the RED (OnStar® Emergency Button) at any time during the installation. This will cause module configuration issues.

If you inadvertently press the RED (OnStar® Emergency Button) during installation, you will not be able to complete the final configuration with the advisor until the next day.

16. Turn the ignition to the ON position and press the OnStar® Blue Button to call OnStar®.

Note: The vehicle must be located in an area with a strong cellular network to perform this step.

Important: The customer **SHOULD NOT** be the first one to press the OnStar® Blue Button after installation.

- 16.1. The technician will hear a message stating "Hello and welcome to OnStar®. Your OnStar® account is currently inactive". Please push the OnStar® Blue Button again to activate your account, learn more about OnStar® services, or speak to an OnStar® Advisor.

- 16.2. The technician will announce themselves by first name, dealership name and explain the vehicle has been upgraded for **Canadian CDMA Transitions**.

Note: During activation with the OnStar® Advisor, the French Language option may be requested.

- 16.3. OnStar® advisor will confirm that the vehicle is set up correctly and if no issues were identified.
17. If the OnStar® advisor identifies an issue they will complete a manual configuration while on the call. The technician will complete the manual configuration call with the OnStar® Advisor.
- 17.1. The technician will need to provide the following information for a manual configuration:
- Customer Name
 - Dealer Code with Division
 - Vehicle VIN or:
- ⇒ OnStar® Account Number
- ⇒ Old STID – located on the label of the original module (for customer vehicles this is also located on the Upgrade kit packing slip)
- ⇒ Customer Phone Number
18. Upon confirmation of successful hardware installation, the procedure is complete.

For Vehicle MY 2005-2010 Vibe, Follow the Instructions Listed Below:

Note: Technician will verify VIN and customer information on Kit with VIN of installation vehicle (do not install hardware if VIN does not match)

Important: Certain OnStar® equipped vehicles may be equipped with a back-up battery. The back-up battery is a non-rechargeable, lithium battery intended to provide an auxiliary power source for the telematics communication interface module in the event of a vehicle collision where power from the main vehicle battery is lost. Disconnecting power to the OnStar® module in any way while the ignition is ON or with retained accessory power (RAP) activated may cause activation of the OnStar® Back-Up Battery. Once the Back-Up Battery is activated it will stay on until the power is restored back to the telematics communication interface control module. The back-up battery is not rechargeable and once discharged below a specified voltage threshold the back-up battery must be replaced.

- MAKE SURE IGNITION IS OFF AND RAP IS DEACTIVATED PRIOR TO REMOVAL OF THE ONSTAR® MODULE.

1. To access the OnStar® module, refer to the Service Information (SI) for the appropriate procedure.

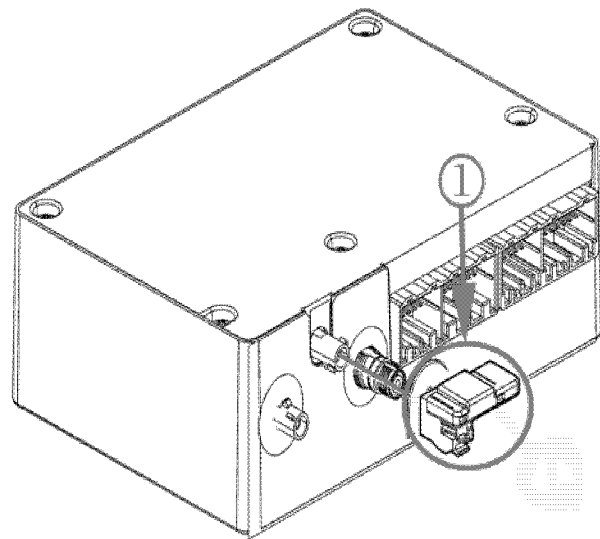

4003867

Note:

- During the installation of the OnStar® 3G/4G LTE module there may be interference with the module to the bracket not allowing the module to fully seat into place. If this occurs please refer to the “OnStar® Module Bracket Modification” section at the end of this bulletin.
 - Some modules are not as thick as the original modules and require installation of foam to the mounting bracket to prevent movement of the module. Refer to the “OnStar® Bracket Modification” section at the end of this bulletin.
 - For labor time adjustment for the modification, please refer to the “OnStar® Bracket Modification” section at the end of this bulletin for information.
2. If installing the modules P/N 23230482, 23230536, 23230537, 23235220, 23235227, 23235234 and 23383877, transfer the Bluetooth Antenna (1), if equipped, to the new module.
- Note:** For all other module P/Ns the Bluetooth Antenna is not required and may be discarded.
3. Install the new module and connect the electrical connectors as necessary.

Note: The vehicle may have two different configurations, with or without UHF cable. Use the appropriate procedure below:

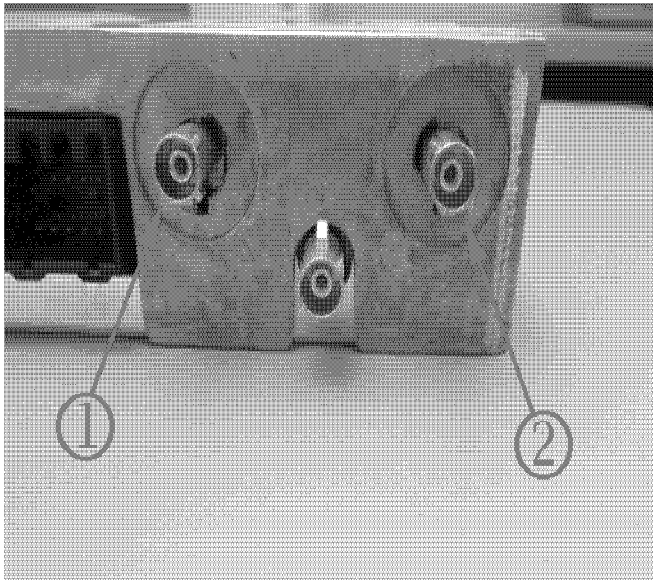

4004061

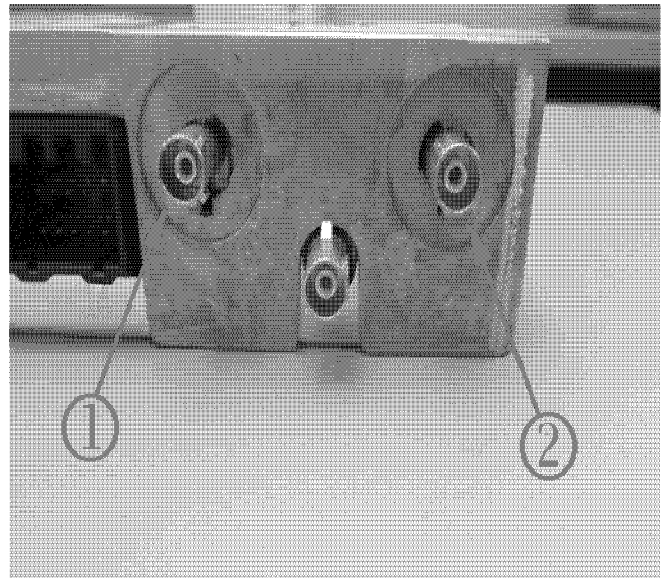

4004061

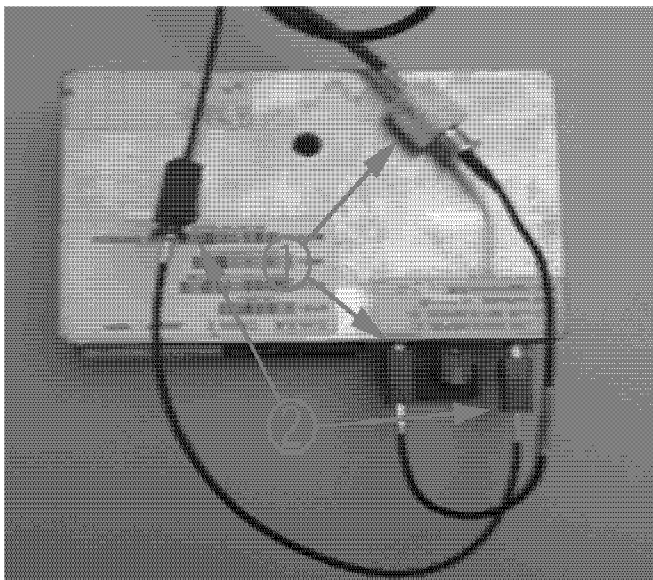

4069297

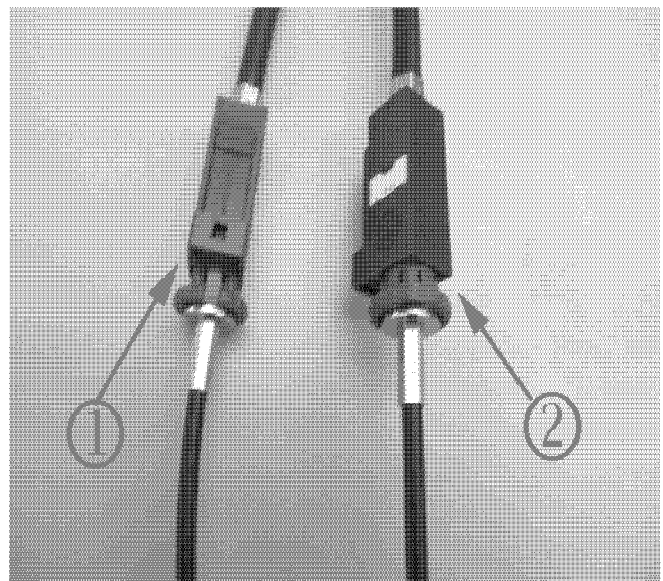

4004070

4. If the vehicle requires a UHF adaptor cable (P/N 23242478) proceed with this step:
 - 4.1. Install the UHF adapter cable (P/N 23242478) to the antenna connector (1) of the module.
 - 4.2. Install the female to male cable (P/N 23242476) to the module (2).
 - 4.3. Connect the UHF adapter (1) and the female to male (2) connector to the vehicle cables.

5. If the vehicle does not require a UHF adaptor cable (P/N 23242478) proceed with this step:
 - 5.1. Install one female to male cable (P/N 23242476) to the antenna connector of the module (1).
 - 5.2. Install one female to male cable (P/N 23242476) to the module connector (2).
 - 5.3. Connect both female to male cables to the vehicle cables.
6. To reassemble the vehicle, refer to the Service Information (SI) for the appropriate procedure.
7. To program the control module, perform the following procedure:

Important: Verify the battery voltage is more than 12 volts but less than 16 volts before proceeding with reprogramming. The battery must be fully charged **BEFORE** reprogramming.

Important: During reprogramming, the battery voltage must be maintained within the proper range of 12-15.5 volts. **CONNECT** the approved Midtronics® PSC 550 Battery Maintainer (SPS Programming Support Tool (EL-49642) to the vehicle or the GR8 (EL50313) in the power supply mode.

8. 2005-2010 Vibe Programming Instructions

Important: The EL-49642 SPS programming support tool cannot be used to program the new Telematics Communication Interface Control Module on Vibe vehicles. The following steps are required to complete the programming of the new module. The new module programming will be performed by on OnStar over-the-air.

- 8.1. Ensure that the vehicle is in an area with good cellular coverage.
- 8.2. Contact OnStar TAC at 1-800-263-7740 English or 1-800-263-7960 French, Option 4 (OnStar) for programming direction between hours of 8AM and 4PM EST. Have OnStar 3G/4G Upgrade Program Packing Slip available for reference.
- 8.3. Complete instruction provide by OnStar advisor.
- 8.4. Move to Step 9.

9. Turn the ignition to the OFF position and wait ten minutes.

Notice: A 10 minute wait time is required to avoid configuration errors.

Note: Do **NOT** press the RED (OnStar® Emergency Button) at any time during the installation. This will cause module configuration issues.

If you inadvertently press the RED (OnStar® Emergency Button) during installation you will not be able to complete the final configuration with the advisor until the next day.

10. Turn the ignition to the ON position and press the OnStar® Blue Button to call OnStar®.

Note: The vehicle must be located in an area with a strong cellular network to perform this step.

Important: The customer **SHOULD NOT** be the first one to press the OnStar® Blue Button after installation.

10.1. The technician will hear a message stating "Hello and welcome to OnStar®. Your OnStar® account is currently inactive". Please push the OnStar® Blue Button again to activate your account, learn more about OnStar® services, or speak to an OnStar® Advisor.

10.2. The technician will announce themselves by first name, dealership name and explain the vehicle has been upgraded for **Canadian CDMA Transitions**.

Note: During activation with the OnStar® Advisor, the French Language option may be requested.

10.3. OnStar® advisor will confirm that the vehicle is set up correctly and if no issues were identified.

11. If the OnStar® advisor identifies an issue they will complete a manual configuration while on the call. The tech will complete the manual configuration call with the OnStar® Advisor.

11.1. The technician will need to provide the following information for a manual configuration:

Customer Name

Dealer Code with Division

Vehicle VIN or:

⇒ OnStar® Account Number

⇒ Old STID – located on the label of the original module

⇒ Customer Phone Number

12. Upon confirmation of successful hardware installation, the procedure is complete.

For Vehicle MY 2010 and Older, Follow the Instructions Listed Below:

Note: Technician will verify VIN and customer information on Kit with VIN of installation vehicle (do not install hardware if VIN does not match)

Important: Certain OnStar® equipped vehicles may be equipped with a back-up battery. The back-up battery is a non-rechargeable, lithium battery intended to provide an auxiliary power source for the telematics communication interface module in the event of a vehicle collision where power from the main vehicle battery is lost. Disconnecting power to the OnStar® module in any way while the ignition is ON or with retained accessory power (RAP) activated may cause activation of the OnStar® Back-Up Battery. Once the Back-Up Battery is activated it will stay on until the power is restored back to the telematics communication interface control module. The back-up battery is not rechargeable and once discharged below a specified voltage threshold the back-up battery must be replaced.

- MAKE SURE IGNITION IS OFF AND RAP IS DEACTIVATED PRIOR TO REMOVAL OF THE ONSTAR® MODULE.

1. To access the OnStar® module, refer to the Service Information (SI) for the appropriate procedure.

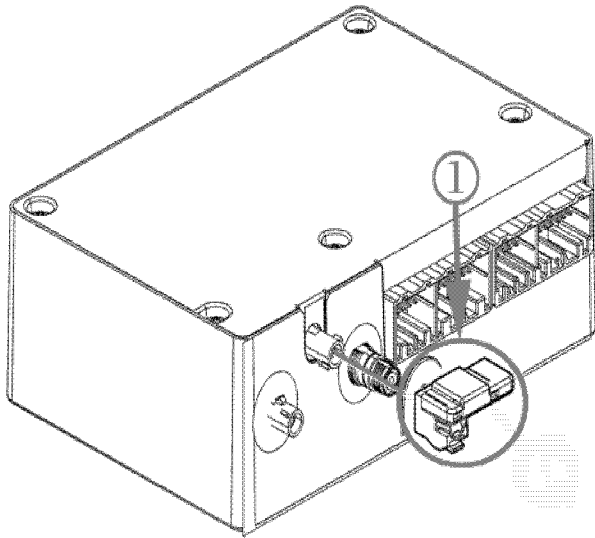

4003867

Note:

- During the installation of the OnStar® 3G/4G LTE module there may be interference with the module to the bracket not allowing the module to fully seat into place. If this occurs please refer to the “OnStar® Module Bracket Modification” section at the end of this bulletin.
 - Some modules are not as thick as the original modules and require installation of foam to the mounting bracket to prevent movement of the module. Refer to the “OnStar® Bracket Modification” section at the end of this bulletin.
 - For labor time adjustment for the modification, please refer to the “OnStar® Bracket Modification” section at the end of this bulletin for information.
2. If installing the modules P/N 23230482, 23230536, 23230537, 23235220, 23235227, 23235234 and 23383877, transfer the Bluetooth Antenna (1), if equipped, to the new module.

Note: For all other module P/Ns the Bluetooth Antenna is not required and may be discarded.

Important: Vehicles with voice recognition systems may have a performance issue after the upgrade. “PI1533 - Poor Radio Hands-free Voice Recognition Performance” is required to prevent this issue.

3. Vehicles with Bluetooth or Navigation with RPOs (U3U, UZR, UUM, UH4, U2X, UY2, UAV, PCK, GQM, UYS, UFU+UP9, UEW), perform PI1533.
4. Install the new module and connect the electrical connectors as necessary.

Note: The vehicle may have two different configurations, with or without UHF cable. Use the appropriate procedure below:

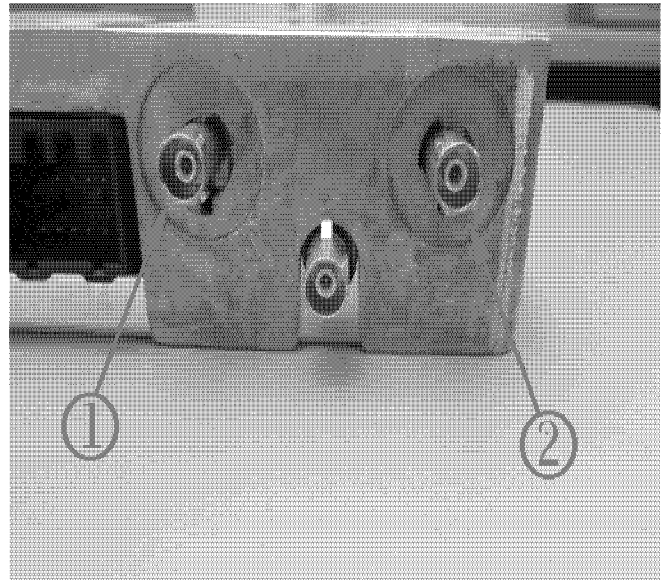

4004061

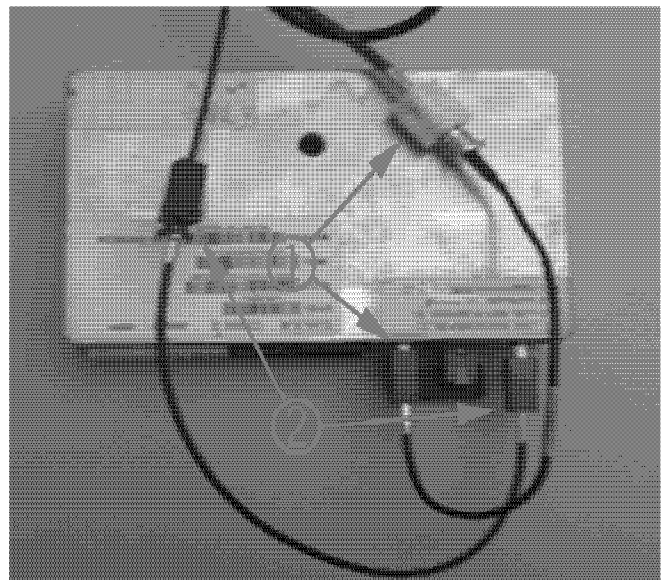

4069297

5. If the vehicle requires a UHF adaptor cable (P/N 23242478) proceed with this step:
 - 5.1. Install the UHF adapter cable (P/N 23242478) to the antenna connector (1) of the module.
 - 5.2. Install the female to male cable (P/N 23242476) to the module (2).
 - 5.3. Connect the UHF adapter (1) and the female to male (2) connector to the vehicle cables.

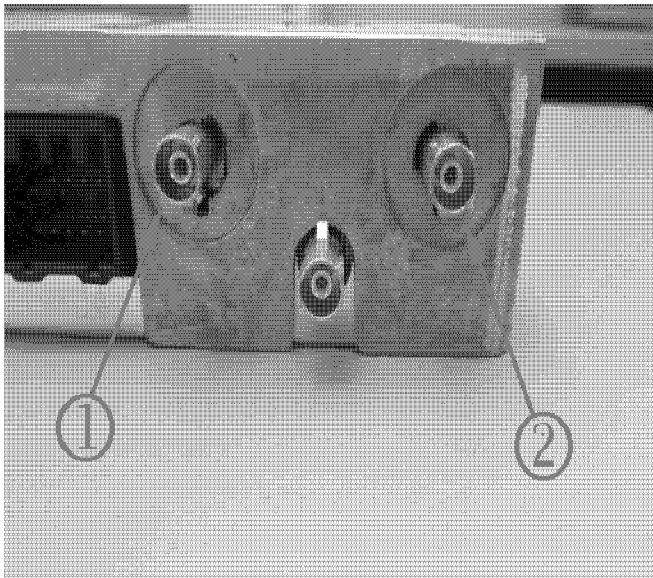

4004061

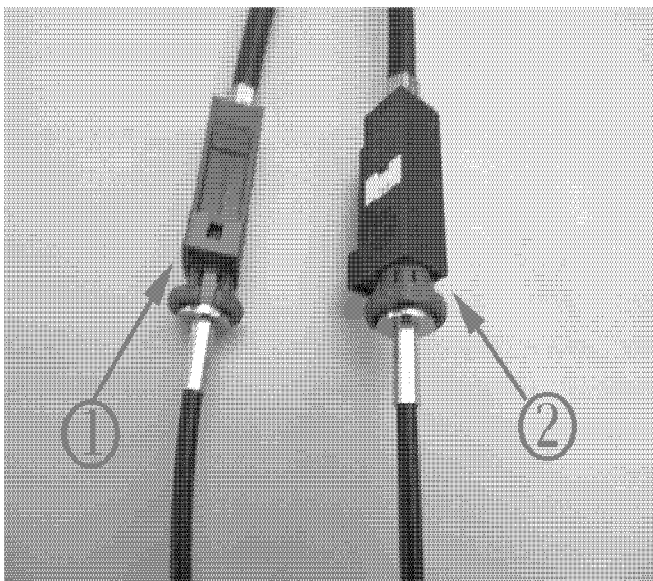

4004070

6. If the vehicle does not require a UHF adaptor cable (P/N 23242478) proceed with this step:
 - 6.1. Install one female to male cable (P/N 23242476) to the antenna connector of the module (1).
 - 6.2. Install one female to male cable (P/N 23242476) to the module connector (2).
 - 6.3. Connect both female to male cables to the vehicle cables.

7. To reassemble the vehicle, refer to the Service Information (SI) for the appropriate procedure.
8. To program the control module, perform the following procedure:

Important: Verify the battery voltage is more than 12 volts but less than 16 volts before proceeding with reprogramming. The battery must be fully charged **BEFORE** reprogramming.

Important: During reprogramming, the battery voltage must be maintained within the proper range of 12-15.5 volts. **CONNECT** the approved Midtronics® PSC 550 Battery Maintainer (SPS Programming Support Tool (EL-49642) to the vehicle or the GR8 (EL50313) in the power supply mode.

- 8.1. Install EL-49642 SPS programming support tool.

Note: Due to a change in SPS you must select 'Reprogram ECU', for Telematics Communication Interface Control Module Programming from the Selected Programming Process even if the unit is being replaced.

If 'Replace and Program ECU' is selected the Telematics Communication Interface Control Module will not be listed in the Supported Controllers screen. You must go back and select 'Reprogram ECU.'

- 8.2. In the SPS Supported Controllers screen, depending the model year, there will be one of three options that are listed below.

Select the appropriate option for the vehicle:

- Mobile Telephone Communications Interface Control Module (Use **ONLY** per Bulletin 15-08-44-001)
- Telematics Communication Interface Control Module (Use **ONLY** per Bulletin 15-08-44-001)
- Vehicle Communication Interface Module (Use **ONLY** per Bulletin 15-08-44-001)

- 8.3. Follow the on-screen instructions to complete programming.

Note: If there is a programming issue, please contact Techline Customer Support Center (TCSC) at 1-800-828-6860 (1-800-503-3222 for French).

9. Review table below for specific module/vehicle configuration steps.

Item	Steps
<p>Step 9a. P/Ns 23230538, 23232607, 23233066 or 84021666, 23230483 or 84021667 ONLY (GEN 10 modules)</p>	<p>Important: Failure to perform this step may result in an "Engine Power Reduced" message on DIC or "Check Engine light illumination" while maintaining normal engine performance. This may occur immediately after an OnStar blue button press configuration or soon afterwards.</p> <p>Perform Remote Vehicle Speed Limiting Reset using GDS2 as follows: (GEN 10 modules only, see note above).</p> <p>⇒ Navigation path for vehicles with GDS2 support for ALL vehicle modules:</p> <ul style="list-style-type: none"> - Module Diagnostics Telematics Communication Interface Module Configuration/Reset Functions Remove/Reset Module Remote Vehicle Speed Limiting Reset <p>⇒ Navigation path for vehicles with GDS2 support for the OnStar module ONLY (all other module communications remain supported by Tech 2 (refer to Bulletin 15-08-73-001))</p> <ul style="list-style-type: none"> - Additional Options OnStar Canada GSM Module Diagnostics Telematics Communication Interface Module Configuration/Reset Functions Remove/Reset Module Remote Vehicle Speed Limiting Reset

Item	Steps
<p>Step 9b. Vehicles with a "glass" <u>mounted OnStar</u> <u>antenna</u> ONLY.</p>	<p>Important: This step should not be performed for vehicles with a "roof" mounted antenna.</p> <p>Important: Failure to perform the Window Antenna Calibration steps may result in the OnStar system status displaying a "Red light" indicating a problem. (Blue OnStar button operates normally)</p> <p>Perform Mobile Telephone Antenna Setup using GDS2 as follows: (required for vehicles equipped with a "Glass" mounted OnStar antenna, see note above).</p> <p>⇒ Navigation path for vehicles with GDS2 support for the OnStar module ONLY (all other module communications remain supported by Tech 2 (refer to Bulletin 15-08-73-001))</p> <ul style="list-style-type: none"> - Additional Options OnStar Canada GSM Module Diagnostics Telematics Communication Interface Module Configuration/Reset Functions Remove/Reset Module Mobile Telephone Antenna Setup <p>Important: Back out of the scan tool page and perform a power cycle of the OnStar module by disconnecting it or pulling the fuse</p>

10. Turn the ignition to the OFF position and wait ten minutes.

Notice: A 10 minute wait time is required to avoid configuration errors.

Note: Do **NOT** press the RED (OnStar® Emergency Button) at any time during the installation. This will cause module configuration issues.

If you inadvertently press the RED (OnStar® Emergency Button) during installation you will not be able to complete the final configuration with the advisor until the next day.

11. Turn the ignition to the ON position and press the OnStar® Blue Button to call OnStar®.

Note: The vehicle must be located in an area with a strong cellular network to perform this step.

Important: The customer **SHOULD NOT** be the first one to press the OnStar® Blue Button after installation.

11.1. The technician will hear a message stating "Hello and welcome to OnStar®. Your OnStar® account is currently inactive". Please push the OnStar® Blue Button again to activate your account, learn more about OnStar® services, or speak to an OnStar® Advisor.

11.2. The technician will announce themselves by first name, dealership name and explain the vehicle has been upgraded for **Canadian CDMA Transitions**.

Note: During activation with the OnStar® Advisor, the French Language option may be requested.

11.3. OnStar® advisor will confirm that the vehicle is set up correctly and if no issues were identified.

12. If the OnStar® advisor identifies an issue they will complete a manual configuration while on the call. The tech will complete the manual configuration call with the OnStar® Advisor.

12.1. The technician will need to provide the following information for a manual configuration:

Customer Name

Dealer Code with Division

Vehicle VIN or:

- ⇒ OnStar® Account Number
- ⇒ Old STID – located on the label of the original module
- ⇒ Customer Phone Number

13. Upon confirmation of successful hardware installation, the procedure is complete.

For Vehicle MY 2011 and Above, Follow the Instructions Listed Below:

Note:

- 2013-2015 Vehicles with radio RPO's IO3, IO4, IO5, IO6, or (RAO-UA3) (ATS Base Radio) Ensure that the radio has the latest calibration available on TIS2WEB prior to proceeding with the OnStar® cellular communication upgrade. As stated previously in this bulletin, the "Audio Soft Version" label should be 000474 or lower before continuing. If version 000477 is already installed, reprogramming is not necessary. **DO NOT** reprogram. Software corruption may occur.

Important: The radio calibration update will erase or reset some customer radio and/or vehicle settings to factory default.

- The colors of the cable in the images in the instructions listed below may not depict the colors of the cables received. The use of colored cables are for illustration purposes only. Technician will verify VIN and customer information on Kit with VIN of installation vehicle (do not install hardware if VIN does not match).

Important: Certain OnStar® equipped vehicles may be equipped with a back-up battery. The back-up battery is a non-rechargeable, lithium battery intended to provide an auxiliary power source for the telematics communication interface module in the event of a vehicle collision where power from the main vehicle battery is lost. Disconnecting power to the OnStar® module in any way while the ignition is ON or with retained accessory power (RAP) activated may cause activation of the OnStar® Back-Up Battery. Once the Back-Up Battery is activated it will stay on until the power is restored back to the telematics communication

interface control module. The back-up battery is not rechargeable and once discharged below a specified voltage threshold the back-up battery must be replaced.

- **MAKE SURE IGNITION IS OFF AND RAP IS DEACTIVATED PRIOR TO REMOVAL OF THE ONSTAR® MODULE.**

1. To access the OnStar® module, refer to the Service Information (SI) for the appropriate procedure.

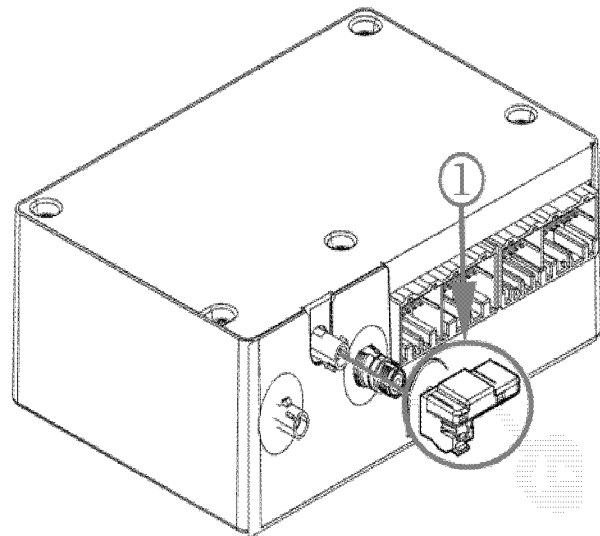

4003867

Note:

- During the installation of the OnStar® 3G/4G LTE module there may be interference with the module to the bracket not allowing the module to fully seat into place. If this occurs please refer to the "OnStar® Module Bracket Modification" section at the end of this bulletin.
 - Some modules are not as thick as the original modules and require installation of foam to the mounting bracket to prevent movement of the module. Refer to the "OnStar® Bracket Modification" section at the end of this bulletin
 - For labor time adjustment for the modification, please refer to the "OnStar® Bracket Modification" section at the end of this bulletin for information.
2. If installing the modules P/N 23230482, 23230536, 23230537, 23235220, 23235227, 23235234 and 23383877, transfer the Bluetooth Antenna (1), if equipped, or supplied (2012 Colorado/Canyon, P/N15938939) to the new module. Refer to *Wireless Communication Interface Antenna Replacement* in SI.

Note: For all other module P/Ns the Bluetooth Antenna is not required and may be discarded.

3. Install the new module and connect the electrical connectors as necessary.

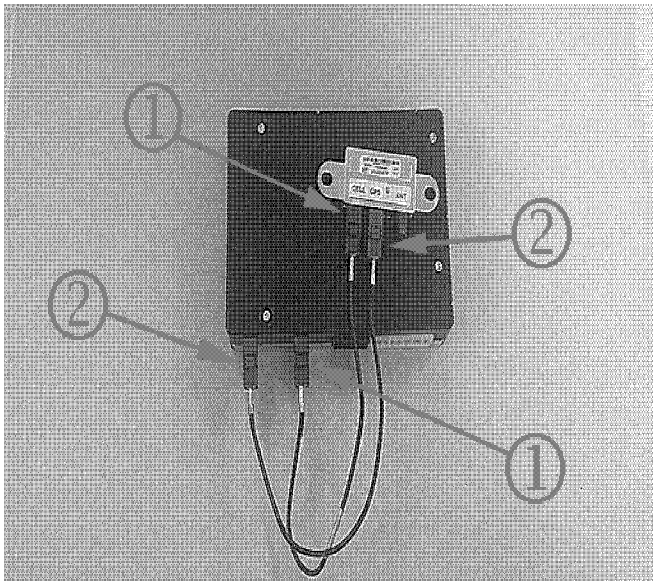

4013102

Note: During installation of the antenna cable and the cellular cable to the splitter, if the cables inadvertently become incorrectly installed, the technician may notice a red LED with DTCs B101D-3C and B101D-F0 set as current in the OnStar VCIM.

Note: The “upgrade” splitter is an additional piece of hardware and must be installed at the VCIM. If present, DO NOT remove any existing splitters during installation.

4. Connect the male to male cable (P/N 23310710) to the cellular connector (1) to the splitter as shown above.
5. Connect the male to male cable (P/N 23242477) to the GPS connector (2) to the splitter as shown above.

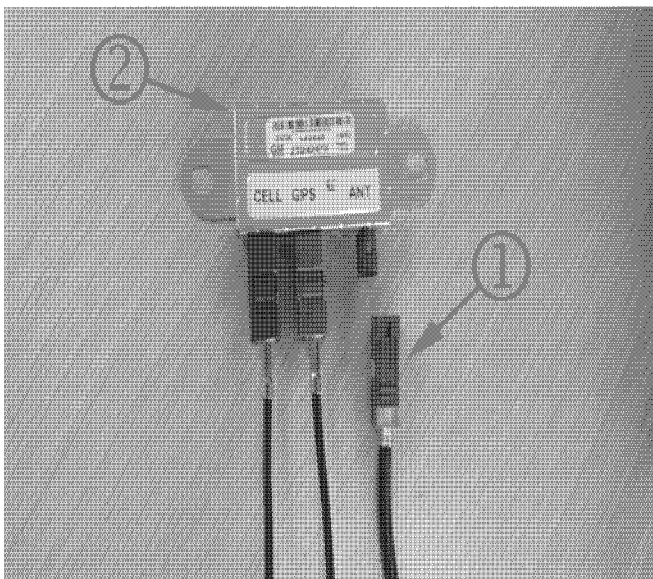

4013203

6. Connect the antenna cable (1) from the vehicle to the “upgrade” splitter (2).

7. If no mounting location for the splitter, secure the splitter (1) to the vehicle to prevent a rattle or damage to the splitter.
8. To reassemble the vehicle, refer to the Service Information (SI) for the appropriate procedure.

Important: Verify the battery voltage is more than 12 volts but less than 16 volts before proceeding with reprogramming. The battery must be fully charged **BEFORE** reprogramming.

Important: During reprogramming, the battery voltage must be maintained within the proper range of 12-15.5 volts. **CONNECT** the approved Midtronics® PSC 550 Battery Maintainer (SPS Programming Support Tool (EL-49642) to the vehicle or the GR8 (EL50313) in the power supply mode.

9. To program the control module, perform the following procedure:
 - 9.1. Install EL-49642 SPS programming support tool .

Note: Due to a change in SPS you must select ‘Reprogram ECU’, for Telematics Communication Interface Control Module Programming from the Selected Programming Process even if the unit is being replaced.

If ‘Replace and Program ECU’ is selected the Telematics Communication Interface Control Module will not be listed in the Supported Controllers screen. You must go back and select ‘Reprogram ECU.’

- 9.2. In the SPS Supported Controllers screen, depending the model year, there will be one of three options that are listed below. Select the appropriate option for the vehicle:
 - Mobile Telephone Communications Interface Control Module (Use ONLY per Bulletin 15-08-44-001)
 - Telematics Communication Interface Control Module (Use ONLY per Bulletin 15-08-44-001)
 - Vehicle Communication Interface Module (Use ONLY per Bulletin 15-08-44-001)
- 9.3. Follow the on-screen instructions to complete programming.

Note: If there is a programming issue, please contact Techline Customer Support Center (TCSC) at 1-800-828-6860 (1-800-503-3222 for French).

Notice: Step 10 is an additional step required for GEN 10 modules ONLY (module P/Ns 23230538, 23232607, 23233066 or 84021666, 23230483 or 84021667).

Important: Failure to perform this step may result in an “Engine Power Reduced” message on DIC or “Check Engine light illumination” while maintaining normal engine performance. This may occur immediately after an OnStar blue button press configuration or soon afterwards

10. Perform **Remote Vehicle Speed Limiting Reset** using GDS2 as follows: (GEN 10 modules only, see note above).
- ⇒ Navigation path for vehicles with GDS2 support for ALL vehicle modules:
 - Module Diagnostics | Telematics Communication Interface Module | Configuration/Reset Functions | Remove/Reset Module | Remote Vehicle Speed Limiting Reset
 - ⇒ Navigation path for vehicles with GDS2 support for the OnStar module ONLY (all other module communications remain supported by Tech 2 (refer to Bulletin 15-08-73-001))
 - Additional Options | OnStar Canada GSM | Module Diagnostics | Telematics Communication Interface Module | Configuration/Reset Functions | Remove/Reset Module | Remote Vehicle Speed Limiting Reset
11. Turn the ignition to the OFF position and wait ten minutes.

Notice: A 10 minute wait time is required to avoid configuration errors.

Note: Do **NOT** press the RED (OnStar® Emergency Button) at anytime during the installation. This will cause module configuration issues.

If you inadvertently press the RED (OnStar® Emergency Button) during installation you will not be able to complete the final configuration with the advisor until the next day.

12. Turn the ignition to the ON position and press the OnStar® Blue Button to call OnStar®.

Note: The vehicle must be located in an area with a strong cellular network to perform this step.

Important: The customer **SHOULD NOT** be the first one to press the OnStar® Blue Button after installation.

- 12.1. The technician will hear a message stating "Hello and welcome to OnStar®. Your OnStar® account is currently inactive". Please push the OnStar® Blue Button again to activate your account, learn more about OnStar® services, or speak to an OnStar® Advisor.

- 12.2. The technician will announce themselves by first name, dealership name and explain the vehicle has been upgraded for **Canadian CDMA Transitions**. If the vehicle is a new unsold unit, inform the advisor so the OnStar® demo setting is initiated.

Note: During activation with the OnStar® Advisor, the French Language option may be requested.

- 12.3. OnStar® advisor will confirm that the vehicle is set up correctly and if no issues were identified

13. If the OnStar® advisor identifies an issue they will complete a manual configuration while on the call. The technician will complete the manual configuration call with the OnStar® Advisor.

- 13.1. The technician will need to provide the following information for a manual configuration:

- Customer Name
- Dealer Code with Division
- Vehicle VIN or:

⇒ OnStar® Account Number

⇒ Old STID – located on the label of the original module

⇒ Customer Phone Number

14. Upon confirmation of successful hardware installation, the procedure is complete unless the vehicle is an unsold vehicle on a dealer lot, proceed to the next step.

15. Apply the OnStar® 4G Wi-Fi sticker to the vehicle near the price and fuel economy label, the vehicle is ready for sale.

Parts Information

OnStar® Module Chart

Vehicle Line and Model Year	Module Part Number	Model Year 2011 & Above			Model Year 2010 & Under	
		Splitter	Male to Male Universal	Male to Male Keyed	Female to Male Cable	UHF Adaptor Cable
Buick Allure 2005-2009	23230482				23242476	23242478
Buick Century 2004	23230482				23242476	23242478
Buick Enclave 2008-2015	23233066 or 84021666	23242479	23242477	23310710	23242476 (2X)	
Buick Encore 2013-2014	23230538	23242479	23242477	23310710		
Buick LaCrosse 2005-2009	23230482				23242476	23242478
Buick LaCrosse 2010-2014	23230538	23242479	23242477	23310710	23242476 (2X)	
Buick LeSabre 2000-2005	23230482				23242476	23242478
Buick Lucerne 2006-2011	23230483 or 84021667	23242479	23242477	23310710	23242476 (2X)	
Buick Rainier 2004-2007	23235234				23242476	23242478
Buick Regal 2004	23230482				23242476	23242478
Buick Regal 2011-2014	23230538	23242479	23242477 (May require 90 degree cable 13581153)	23310710	23242476 (2X for 2011 MY without RPO AUA)	
Buick Rendezvous 2003-2007	23235234				23242476	23242478
Buick Terraza 2005-2007	23235234				23242476	23242478
Buick Verano 2012-2014	23230538	23242479	23242477 (May require 90 degree cable 13581153)	23310710		
Cadillac ATS 2013-2014	23232607	23242479	23242477	23310710		
Cadillac CTS 2003-2007	23230482				23242476	23242478
Cadillac CTS 2008-2010	23230483 or 84021667				23242476 (2X)	
Cadillac CTS Sedan 2011-2013	23230483 or 84021667	23242479	23242477	23310710		
Cadillac CTS Sedan 2014	23232607	23242479	23242477	23310710		

OnStar® Module Chart (cont'd)

Cadillac CTS except Sedan	2008-2015					
	23230483 or 84021667	23242479	23242477	23310710	23242476	23242478
	2003-2007					
	23230482				23242476	23242478
Cadillac DeVille DHS/DTS 2002-2005	23235234				23242476	23242478
Cadillac DTS 2006-2011	23230483 or 84021667	23242479	23242477	23310710	23242476 (2X)	
Cadillac ELR* 2014	23230538	23242479	23242477	23310710		
Cadillac Escalade Models	2015					
	23230538	23242479	23242477	23310710		
	2007-2014					
	23233066 or 84021666	23242479	23242477	23310710	23242476 (2X)	
	2003-2006					
	23230482				23242476	23242478
Cadillac Funeral Coach 2007-2010	23230483 or 84021667				23242476 (2X)	
Cadillac Funeral Coach 2011	23230483 or 84021667	23242479	23242477	23310710	23242476 (2X)	
Cadillac Funeral Coach 2013-2015	23230538	23242479	23242477	23310710	23242476 (2X)	
Cadillac Limousine	23230483 or 84021667	23242479	23242477	23310710	23242476 (2X)	
Cadillac Seville SLS/STS 2002-2003	23235234				23242476	23242478
Cadillac SRX	2013-2014					
	23232607	23242479	23242477	23310710	23242476 (2X)	
	2010-2012					
	23230538	23242479	23242477	23242477	23242476 (2X)	
	2007-2009					
	23230483 or 84021667				23242476 (2X)	
	2004-2006					
	23235234				23242476	23242478
Cadillac STS 2005-2011	23235227				23242476	23242478
Cadillac XLR Roadster 2004-2009	23230536				23242476	23242478

OnStar® Module Chart (cont'd)

Cadillac XTS 2013-2014	23230538	23242479	23242477	23310710		
Chevrolet Avalanche	2007-2013					
	23233066 or 84021666	23242479	23242477	23310710	23242476 (2X)	
	2003-2006					
	23235234					
Chevrolet Aveo 2009-2011	23230483 or 84021667				23242476 (2X)	
Chevrolet Camaro 2010-2015	23230538	23242479	23242477	23310710	23242476 (2X)	
Chevrolet Captiva (VIN L) 2012-2015	23230483 or 84021667	23242479	23242477	23310710		
Chevrolet Cavalier 2004	23235234				23242476	23242478
Chevrolet Cobalt 2005-2010	23235220				23242476	23242478
Chevrolet Colorado 2004-2012	23235234	23242479	23242477	23310710	23242476	23242478
Chevrolet Colorado 2012	Bluetooth Antenna 15938939					
Chevrolet Corvette	2014					
	23230538	23242479	23242477	23310710		
	2007-2008 Z06 and 2009-2013 All Models					
	23230536	23242479	23242477	23310710	23242476	23242478
	2005-2008 Coupe and Convertible					
	23230537	23242479		23310710	23242476	23242478
Chevrolet Cruze 2011-2014	23230538	23242479	23242477	23310710		
Chevrolet Equinox	2010-2014					
	23232607	23242479	23242477	23310710	23242476 (2X)	
	2007-2009					
	23230483 or 84021667				23242476 (2X)	
	2005-2006					
	23399653				23242476	23242478
Chevrolet Express	2011-2015					
	23233066 or 84021666	23242479	23242477	23310710		
	2004-2005					
	23230482				23242476	23242478
Chevrolet HHR 2006-2011	23235227				23242476	23242478

OnStar® Module Chart (cont'd)

Chevrolet Impala	2014					
	23232607	23242479	23242477	23310710		
	2006-2013					
	23230483 or 84021667	23242479	23242477	23310710	23242476 (2X)	
	2001-2005					
	23230482				23242476	23242478
Chevrolet Malibu	2013-2014					
	23230538	23242479	23242477	23310710		
	2004-2012					
	23235227	23242479	23242477	23310710	23242476	23242478
Chevrolet Monte Carlo	2006-2007					
	23230483 or 84021667				23242476 (2X)	
	2001-2005					
	23230482				23242476	23242478
Chevrolet Orlando 2011-2014	23230538	23242479	23242477	23310710		
Chevrolet SS 2014	23230538	23242479	23242477	23310710	23242476 (2X)	
Chevrolet Silverado	2014 Silverado 1500 and 2015 Silverado 2500/3500					
	23230538	23242479	23242477	23310710		
	2007-2013 Silverado and 2014 Silverado 2500/3500					
	23233066 or 84021666	23242479	23242477	23310710	23242476 (2X)	
	2003-2006 Silverado and 2007 Silverado Classic					
	23230482				23242476	23242478
Chevrolet Sonic 2012-2014	23230538	23242479	23242477	23310710		
Chevrolet Spark 2013-2014	23232607	23242479	23242477	23310710		
Chevrolet Suburban	2015					
	23230538	23242479	23242477	23310710		
	2007-2014					
	23233066 or 84021666	23242479	23242477	23310710	23242476 (2X)	
	2003-2006					
	23230482				23242476	23242478
Chevrolet Trail Blazer 2002-2009	23235234				23242476	23242478
Chevrolet Tahoe	2015					
	23230538	23242479	23242477	23310710		
	2007-2014					
	23233066 or 84021666	23242479	23242477	23310710	23242476 (2X)	
	2003-2006					
	23230482				23242476	23242478

OnStar® Module Chart (cont'd)

Chevrolet Traverse 2009-2015	23233066 or 84021666	23242479	23242477	23310710	23242476 (2X)	
Chevrolet Trax 2013-2014	23230538	23242479	23242477	23310710		
Chevrolet Uplander 2005-2009	23235234				23242476	23242478
Chevrolet Venture 2003-2005	23235234				23242476	23242478
Chevrolet Volt* 2011-2014	23230538	23242479	23242477	23310710		
GMC Acadia 2007-2015	23233066 or 84021666	23242479	23242477	23310710	23242476 (2X)	
GMC Canyon 2004-2012	23235234	23242479	23242477	23310710	23242476	23242478
GMC Canyon 2012	Bluetooth Antenna 15938939					
GMC Envoy 2002-2009	23235234				23242476	23242478
GMC Savana	2011-2015					
	23233066 or 84021666	23242479	23242477	23310710	23242476 (2X)	
	2004-2005					
	23230482				23242476	23242478
	2003					
23230482				23242476	23242478	
GMC Sierra Models	2014 Sierra 1500 and 2015 Sierra 2500/3500					
	23230538	23242479	23242477	23310710		
	2007-2013 Sierra and 2014 Sierra 2500/3500					
	23233066 or 84021666	23242479	23242477	23310710	23242476 (2X)	
	2003-2006 Sierra and 2007 Sierra Classic					
23230482				23242476	23242478	
GMC Terrain 2010-2014	23232607	23242479	23242477	23310710	23242476 (2X)	
GMC Yukon Models	2015					
	23230538	23242479	23242477	23310710		
	2007-2014					
	23233066 or 84021666	23242479	23242477	23310710	23242476 (2X)	
	2003-2006					
23230482				23242476	23242478	
HUMMER H2	2008-2010					
	23233066 or 84021666				23242476 (2X)	
	2003-2007					
23235234				23242476	23242478	
HUMMER H3 2006-2010	23235234				23242476	23242478

OnStar® Module Chart (cont'd)

Oldsmobile Aurora 2001-2003	23230482				23242476	23242478
Oldsmobile Bravada 2002-2004	23235234				23242476	23242478
Oldsmobile Silhouette 2003-2004	23235234				23242476	23242478
Pontiac Aztek 2003-2005	23235234				23242476	23242478
Pontiac Bonneville 2000-2005	23230482				23242476	23242478
Pontiac G3 2009-2011	23230483 or 84021667					
Pontiac G5 2007-2010	23235220				23242476	23242478
Pontiac G6 2005-2010	23235227	23242479	23242477	23310710	23242476	23242478
Pontiac G8 2008-2009	23233066 or 84021666				23242476 (2X)	
Pontiac Grand Prix 2004-2008	23383877				23242476	23242478
Pontiac Montana/SV6 2003-2009	23235234				23242476	23242478
Pontiac Pursuit 2005-2006	23235220				23242476	23242478
Pontiac Solstice 2006-2010	23235227				23242476	23242478
Pontiac Sunfire Coupe 2003-2005	23235234				23242476	23242478
Pontiac Torrent	2007-2009					
	23230483 or 84021667				23242476 (2X)	
	2006					
	23399653				23242476	23242478
Pontiac Vibe	2009-2010					
	23230483 or 84021667				23242476 (2X)	
	2005-2008					
	23230482				23242476	23242478
Saturn Astra 2008-2009	23230537				23242476	23242478
Saturn AURA 2007-2011	23235227	23242479	23242477	23310710	23242476	23242478
Saturn ION 2004-2007	23235234				23242476	23242478
Saturn L300 2002-2004	23230482				23242476	23242478
Saturn OUTLOOK 2007-2010	23233066 or 84021666				23242476 (2X)	

OnStar® Module Chart (cont'd)

Saturn RELAY 2005-2007	23235234					
Saturn SKY 2007-2009	23235227				23242476	23242478
Saturn VUE	2008-2010					
	23230483 or 84021667				23242476 (2X)	
	2003-2007					
	23230482				23242476	23242478
*As stated in the Recommendation/Instructions of this bulletin, the #11342: Customer Satisfaction - Enhancements for Side Impact Pole Performance and #PIC5920: Vehicle Will Not Charge And Hybrid Loss Of Isolation With DTC P0AA6 must be completed on the Volt and ELR, if applicable, before proceeding with this bulletin.						

For product ordering information, call a local automotive equipment supplier or call Velcro at 800-683-5276, Kent Automotive at 1-800-563-1717 and 3M™ at 1-800-364-3577.

Part Number	Description	Material Allowance
Velcro 191195*	Velcro® Reclosable Loop Fastener Tape (hook and loop) 2 in X 25 yard	\$2.20 CAD (per vehicle)
KT13487**	BRS Tape KT13487 8 in X 10 in	\$3.25 CAD (per vehicle)
4314***	3M™ Urethane Foam Tape 1/2 in X 18 yards, 1/4 inch thick	\$0.90 CAD (per vehicle)
P46505>	Kent Automotive Adhesive-Back Shim Stock 3/4" Wide X 30 Feet X 7/16" Thick	\$1.50 CAD (per vehicle)
130C<	Scotch™ (3M™) Linerless Rubber Splicing Tape 3/4 in X 30 Feet X .030 in	\$0.80 (per vehicles)

*There is enough material to repair multiple vehicles. Store the remaining materials for future use.

**There is enough material to repair approximately 8 vehicles. Store the remaining materials for future use.

***There is enough material to repair multiple vehicles. Store the remaining material for future use.

>There is enough material to repair about 40 vehicles. Store the remaining material for future use.

<There is enough material to repair about 40 vehicles. Store the remaining material for future use.

Parts Issue (Defective, Damaged, Wrong Parts, Missing Parts, Dealer Trades)

Dealer should contact York Electronics by phone, e-mail, or fax:

Eastern Canada

Phone: English 1-888-650-9675 ext. 307

Phone: French 1-888-650-9675 ext. 302

Fax: 1-888-650-9677

E-mail: info@yorkelec.com

Western Canada

Phone: 1-800-361-2894 ext. 1

Fax: 1-800-361-5396

E-mail: info@yorkelec.com

Warranty Replacements

Article 1.1.3.1 Passenger Cars and Light Duty Trucks

Warranty Does Not Cover

- Condition resulting from negligence, alteration, accident or use for which the part or accessory was not designed or approved by GM;
- Parts and accessories used in racing or other competition;
- Loss of time, inconvenience, loss of use of the vehicle or other economic loss;
- Damage due to the lack of maintenance or use of wrong fluids, fuel, oil, refrigerant or lubricants.

Article 1.2.4.1 Service Agent Replacement Parts and Accessories Warranty Coverage

- GM warrants GM Service Replacement Parts and Accessories to the Service Agent, and it will pay Service Agent for repair or replacement of any defective or malfunctioning part or accessory. The Service Agent Parts and Accessories Warranty applies to all GM Parts and Accessories sold at retail by Service Agent, or used in warranty repairs.
- All new or remanufactured GM Parts and Accessories installed by Service Agent and used in New Vehicle Limited or Emission Warranty repairs are covered, parts and labour, for any remaining unused portion of the Vehicle or Emission Warranty or 12 months/ 20,000 kms. Whichever is greater (12 months, regardless of odometer reading on medium duty trucks). For details see Article 1.1.3.

Note: Effective January 1, 2013 the mileage limitation was removed.

Core Processing

- Cores are **NOT** to be returned to York Electronics.
- Parts are to be disposed as referenced in Article 1.7.3 of the Service Policies and Procedures Manual.

Note: After the 7-day retention period the old modules can be scrapped in the metal recycling or e-recycling as proscribed in your local area.

Claiming Information

Labor Codes	Description
0602058	OnStar® 3G/4G Upgrade – Installation Labour
0602068	OnStar® 3G/4G Upgrade – Mobile Service Admin Allowance
0602078	OnStar® 3G/4G Upgrade – Courtesy Transportation

OnStar® 3G/4G Upgrade Performed by Dealer Service Technician:

Labor Code 0602058: The component R&R labor time should be entered in the Base Labor Time field and the 0.2 hr administrative allowance should be included in the Administration Time field. The \$25 net amount should be submitted in the net item administrative allowance field. (The administrative allowance for electronic components exchanged through York is 0.2 hr handling allowance and \$25 net amount.) This net amount compensation is intended to compensate the Parts Department's effort during the exchange process. For further information, please refer to Article 1.5.10 of the Service Policies and Procedures Manual.

OnStar® 3G/4G Upgrade Performed by York Mobile Service:

For Canadian dealerships only (in Ontario using the York Mobile Service): In the event that a mobile service is provided at the dealership, the R&R labor time and the \$25 net amount are NOT to be claimed; however, the 0.2 hr administrative allowance is claimed once per warranty repair/exchange. (Labor Code 0602068)

Returning The Upgraded Vehicle To The Customer

Leave new OnStar® services information pamphlet in the vehicle.

Labor Time Information

Labor Operation	Vehicle Line and Model Year	Labor Time
OnStar® Module Replacement and Cables Installation 0602058	Buick Allure 2005-2009	0.6 hr
	Buick LaCrosse 2005-2009	0.6 hr
	Buick LaCrosse 2010-2014	Use Published Labor Operation Time for Labor Code: 3422790
	Buick Century 2004	0.7 hr
	Buick Enclave 2008-2015	Use Published Labor Operation Time for Labor Code: 3422790
	Buick Encore 2013-2014	Use Published Labor Operation Time for Labor Code: 3422790. Bracket Modification Add Time: 0.2 hr
	Buick LeSabre 2000-2005	0.5 hr
	Buick Lucerne 2006	0.7 hr
	Buick Lucerne 2007-2011	Use Published Labor Operation Time for Labor Code: 3422790
	Buick Rainier 2004-2007	0.6 hr
	Buick Regal 2004	0.7 hr
	Buick Regal 2011-2014	Use Published Labor Operation Time for Labor Code: 3422790
	Buick Rendezvous 2003	1.0 hr**
	Buick Rendezvous 2004-2007	0.9 hr**
	Buick Terraza 2005-2007	0.9 hr**
	Buick Verano 2012-2014	Use Published Labor Operation Time for Labor Code: 3422790
	Cadillac ATS 2013-2014	Use Published Labor Operation Time for Labor Code: 3422790
	Cadillac CTS 2003-2007	0.7 hr
	Cadillac CTS Sedan 2014	Use Published Labor Operation Time for Labor Code: 3422790
	Cadillac CTS (except Sedan) 2003-2007	0.7 hr
	Cadillac CTS (except Sedan) 2008-2015	Use Published Labor Operation Time for Labor Code: 3422790
	Cadillac DeVille DHS/DTS 2002-2006	0.9 hr**
	Cadillac DTS 2007-2011	Use Published Labor Operation Time for Labor Code: 3422790

	Cadillac ELR* 2014	Use Published Labor Operation Time for Labor Code: 3422790
	Cadillac Escalade Models 2003-2006	1.0 hr
	Cadillac Escalade Models 2007-2015	Use Published Labor Operation Time for Labor Code: 3422790
	Cadillac Funeral Coach 2007-2011	Use Published Labor Operation Time for Labor Code: 3422790
	Cadillac Limousine	Use Published Labor Operation Time for Labor Code: 3422790
	Cadillac Seville SLS/STS 2002-2003	0.8 hr
	Cadillac SRX 2004-2006	1.3 hrs
	Cadillac SRX 2007-2014	Use Published Labor Operation Time for Labor Code: 3422790
	Cadillac STS 2005-2006	1.1 hrs
	Cadillac STS 2007-2011	Use Published Labor Operation Time for Labor Code: 3422790
	Cadillac XLR Roadster 2004-2006	0.5 hr
	Cadillac XLR Roadster 2007-2009	Use Published Labor Operation Time for Labor Code: 3422790
	Cadillac XTS 2013-2014	Use Published Labor Operation Time for Labor Code: 3422790
	Chevrolet Avalanche 2003-2006	1.0 hr
	Chevrolet Avalanche 2007-2013	Use Published Labor Operation Time for Labor Code: 3422790
	Chevrolet Aveo 2009-2011	Use Published Labor Operation Time for Labor Code: 3422790
	Chevrolet Camaro 2010-2015	Use Published Labor Operation Time for Labor Code: 3422790
	Chevrolet Captiva (VIN L) 2012-2015	Use Published Labor Operation Time for Labor Code: 3422790
	Chevrolet Cavalier 2004	1.1 hrs
	Chevrolet Cobalt 2005-2006	1.2 hrs**
	Chevrolet Cobalt 2007-2010	Use Published Labor Operation Time for Labor Code: 3422790 Bracket Modification Add Time: 0.2 hr
	Chevrolet Corvette 2005-2006	0.6 hr
	Chevrolet Corvette 2007-2014	Use Published Labor Operation Time for Labor Code: 3422790
	Chevrolet Colorado 2004-2006	0.9 hr
	Chevrolet Colorado 2007-2012	Use Published Labor Operation Time for Labor Code: 3422790

		Bracket Modification Add Time: 0.2 hr
	Chevrolet Cruze 2011-2014	Use Published Labor Operation Time for Labor Code: 3422790
	Chevrolet Equinox 2006	0.7 hr**
	Chevrolet Equinox 2007-2014	Use Published Labor Operation Time for Labor Code: 3422790
	Chevrolet Express 2004-2005	0.5 hr
	Chevrolet Express 2011-2015	Use Published Labor Operation Time for Labor Code: 3422790
	Chevrolet HHR 2006-2011	Use Published Labor Operation Time for Labor Code: 3422790
	Chevrolet Impala 2001-2006	0.6 hr
	Chevrolet Impala 2007-2014	Use Published Labor Operation Time for Labor Code: 3422790
	Chevrolet Malibu 2004-2006	1.7 hrs
	Chevrolet Malibu 2007-2014	Use Published Labor Operation Time for Labor Code: 3422790
	Chevrolet Monte Carlo 2001-2007	0.6 hr
	Chevrolet Orlando 2011-2014	Use Published Labor Operation Time for Labor Code: 3422790
	Chevrolet SS 2014	Use Published Labor Operation Time for Labor Code: 3422790
	Chevrolet Silverado 2003-2006, 2007 (Classic)	1.0 hr
	Chevrolet Silverado 2007 (New Style), 2008-2015	Use Published Labor Operation Time for Labor Code: 3422790
	Chevrolet Sonic 2012-2014	Use Published Labor Operation Time for Labor Code: 3422790
	Chevrolet Spark 2013-2014	Use Published Labor Operation Time for Labor Code: 3422790
	Chevrolet Suburban 2003-2006	1.0 hr
	Chevrolet Suburban 2007-2015	Use Published Labor Operation Time for Labor Code: 3422790
	Chevrolet TrailBlazer 2002-2009	0.6 hr
	Chevrolet Tahoe 2003-2006	0.6 hr
	Chevrolet Tahoe 2007-2015	Use Published Labor Operation Time for Labor Code: 3422790
	Chevrolet Traverse 2009-2015	Use Published Labor Operation Time for Labor Code: 3422790
	Chevrolet Trax 2013-2014	Use Published Labor Operation Time for Labor Code: 3422790 Bracket Modification Add Time: 0.2 hr

	Chevrolet Uplander 2005-2009	0.9 hr**
	Chevrolet Venture 2003-2005	0.8 hr**
	Chevrolet Volt* 2011-2014	Use Published Labor Operation Time for Labor Code: 3422790
	GMC Acadia 2007-2015	Use Published Labor Operation Time for Labor Code: 3422790
	GMC Canyon 2004-2006	0.9 hr**
	GMC Canyon 2007-2012	Use Published Labor Operation Time for Labor Code: 3422790 Bracket Modification Add Time: 0.2 hr
	GMC Envoy 2007-2009 2002-2006	0.6 hr
	GMC Savana 2003-2005	0.5 hr
	GMC Savana 2011-2015	Use Published Labor Operation Time for Labor Code: 3422790
	GMC Sierra Models 2003-2006	1.0 hr
	GMC Sierra Models 2007-2015	Use Published Labor Operation Time for Labor Code: 3422790
	GMC Terrain 2010-2014	Use Published Labor Operation Time for Labor Code: 3422790
	GMC Yukon Models 2003-2006	1.0 hr
	GMC Yukon Models 2007-2015	Use Published Labor Operation Time for Labor Code: 3422790
	OnStar® Module Replacement and Cables Installation 0602058	HUMMER H2 2003-2007
HUMMER H2 2008-2010		Use Published Labor Operation Time for Labor Code: 3422790
HUMMER H3 2006		0.7 hr
HUMMER H3 2007-2010		Use Published Labor Operation Time for Labor Code: 3422790
Oldsmobile Aurora 2001-2003		0.5 hr
Oldsmobile Bravada 2002-2004		0.6 hr
Oldsmobile Silhouette 2003-2004		0.8 hr**
Pontiac Aztek 2003		0.7 hr
Pontiac Aztek 2004-2005		0.6 hr
Pontiac Bonneville 2000-2005		0.5 hr

Pontiac G3 2009-2011	Use Published Labor Operation Time for Labor Code: 3422790
Pontiac G5 2007-2010	Use Published Labor Operation Time for Labor Code: 3422790 Bracket Modification Add Time: 0.2 hr
Pontiac G6 2005-2006	1.7 hrs
Pontiac G6 2007-2010	Use Published Labor Operation Time for Labor Code: 3422790
Pontiac G8 2008-2009	Use Published Labor Operation Time for Labor Code: 3422790
Pontiac Grand Prix 2004-2006	0.5 hr
Pontiac Grand Prix 2007-2008	Use Published Labor Operation Time for Labor Code: 3422790
Pontiac Montana 2003-2005	0.8 hr**
Pontiac Montana SV6 2005-2009	0.9 hr**
Pontiac Pursuit 2005-2006	1.2 hrs**
Pontiac Solstice 2006	0.8 hr
Pontiac Solstice 2007-2010	Use Published Labor Operation Time for Labor Code: 3422790
Pontiac Sunfire Coupe 2003-2005	1.1 hrs
Pontiac Torrent 2006	0.7 hr**
Pontiac Torrent 2007-2009	Use Published Labor Operation Time for Labor Code: 3422790
Pontiac Vibe 2005-2006	0.6 hr
Pontiac Vibe 2007-2010	Use Published Labor Operation Time for Labor Code: 3422790
Saturn Astra 2008-2009	Use Published Labor Operation Time for Labor Code: 3422790 Bracket Modification Add Time: 0.2 hr
Saturn AURA 2007-2011	Use Published Labor Operation Time for Labor Code: 3422790
Saturn ION 2004-2006	1.2 hrs
Saturn ION 2007	Use Published Labor Operation Time for Labor Code: 3422790
Saturn L300 2002-2004	0.3 hr (Wagon) 0.2 hr (Except Wagon)
Saturn OUTLOOK 2007-2010	Use Published Labor Operation Time for Labor Code: 3422790
Saturn RELAY 2005-2007	0.9 hr**

	Saturn SKY 2007-2009	Use Published Labor Operation Time for Labor Code: 3422790
	Saturn VUE 2003-2006	0.4 hr
	Saturn VUE 2007-2010	Use Published Labor Operation Time for Labor Code: 3422790

*As stated in the Recommendation/Instructions of this bulletin, the #11342: Customer Satisfaction - Enhancements for Side Impact Pole Performance and #PIC5920: Vehicle Will Not Charge And Hybrid Loss Of Isolation With DTC P0AA6 must be completed on the Volt and ELR, if applicable, before performing this bulletin.

**Labor times have been adjusted to provide time allowance for bracket modification on these vehicles.

OnStar® Module Bracket Modification

During the installation of the OnStar® 3G/4G LTE module, there may be interference with the module to the bracket not allowing the module to fully seat into place.

Vehicles listed below may require bracket modifications. For early model vehicles (mostly model year 2007 and older), labor times have been adjusted to provide time allowance for bracket modification. For later model vehicles (mostly model year 2008 and newer), refer to the Labor Time Information section above to utilize "add time" when processing the transaction.

- Buick Encore (2012-2014)
- Buick Rendezvous (2003-2007)
- Buick Terraza (2005-2007)
- Cadillac DeVille/DHS/DTS (2002-2005)
- Chevrolet Cobalt (2005-2010)
- Chevrolet Colorado (2004-2012)
- Chevrolet Cruze (2011-2014)
- Chevrolet Equinox (2006)
- Chevrolet Trax (2013-2014)
- Chevrolet Uplander (2005-2009)
- Chevrolet Venture (2003-2005)
- GMC Canyon (2004-2012)
- Oldsmobile Silhouette (2003-2004)
- Pontiac G5 (2007-2010)
- Pontiac Montana (2003-2005)
- Pontiac Montana SV6 (2005-2009)
- Pontiac Pursuit (2005-2006)
- Pontiac Torrent (2006)
- Saturn Astra (2008-2009)
- Saturn RELAY (2005-2007)

Bracket Modification Instructions

Modification of the bracket and/or installation of material to the module may be required to secure the new 3G/4G LTE module into place.

Follow the appropriate instructions if this condition exists:

Buick Encore (2013-2014) / Chevrolet Trax (2013-2014)

After the original module and bracket is removed.

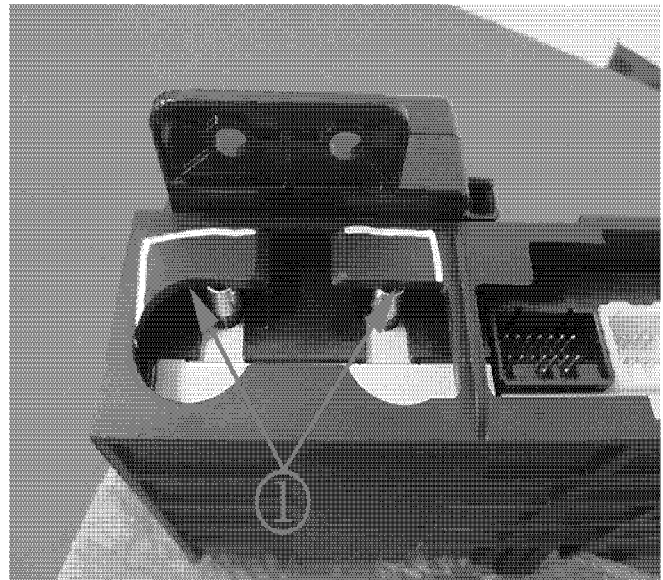

4217690

Remove the illustrated sections (1) of the bracket to allow the module's connectors access.

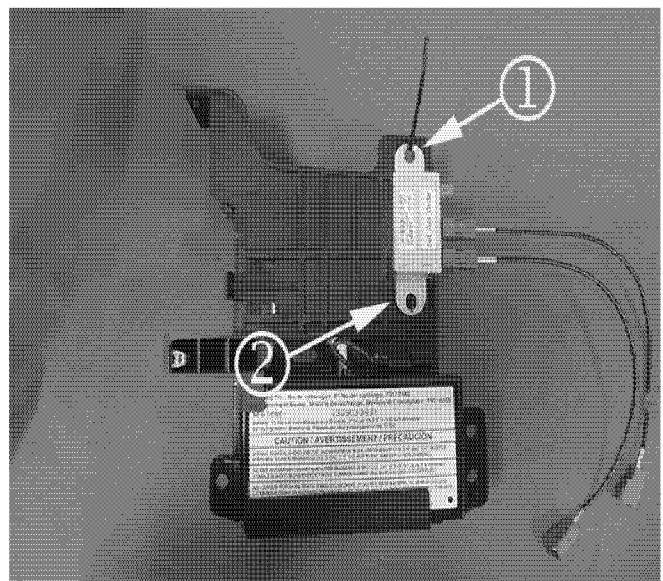

4217741

Secure the splitter to the side of the bracket as illustrated above.

- Install splitter to the hook (2) and position the splitter's connectors toward the module's connectors.
- Secure the splitter with nylon wire tie as illustrated. Trim the excess wire tie material.

Continue with the installation procedure.

Buick Rendezvous (2003-2007)

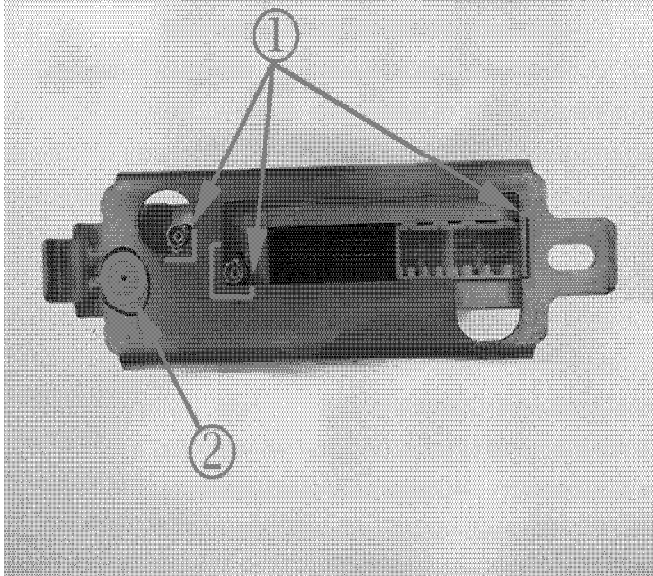

4204771

After the original module is removed.

Remove enough material (1) from the bracket to allow the new module connectors access through the bracket.

Drill a 22.25 mm (7/8 in) hole (2) as illustrated above to allow the module's connector access.

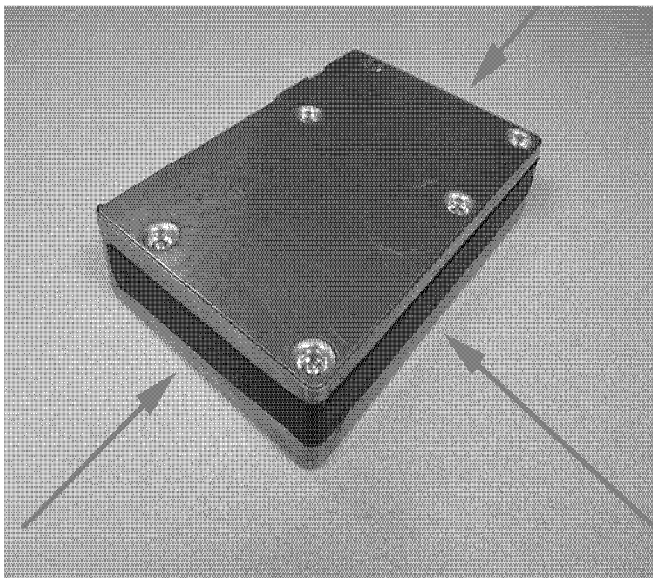

4204795

Wrap the new module with Scotch™ Linerless Rubber Splicing Tape 130C, 19 mm (¾ in) wide, (rubber tape) or equivalent from left to right, covering the back side of the module as illustrated.

Note: Wrapping the module with rubber tape will help prevent movement in the bracket after installed.

Continue with the installation procedure.

Cadillac DeVille/DHS/DTS (2002-2005)



4204917

After the original module is removed.

Remove the corner as illustrated above from the electrical component mounting bracket.

Install two strips of Kent Automotive Adhesive-Back Shim Stock (1) 19 mm (¾ in) thick or equivalent to the bottom of the electrical component mounting bracket as illustrated above.

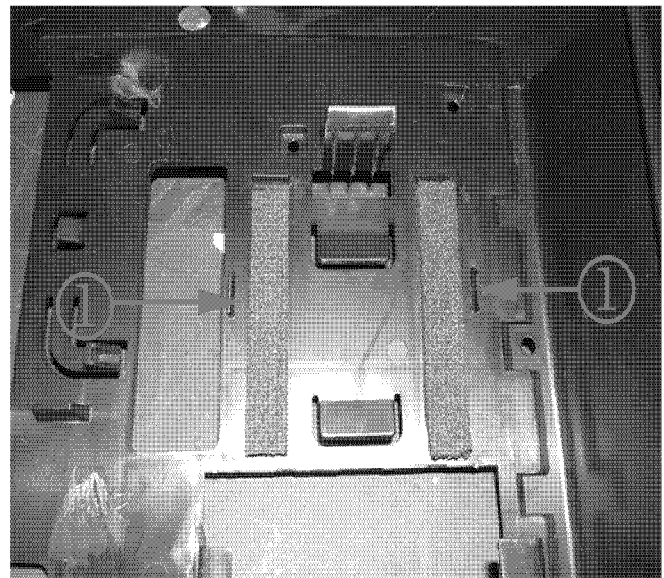

4204940

Install the OnStar® module and secure the module with nylon wire tie as illustrated. Trim the excess wire tie material.

Continue with installation procedure.

Chevrolet Cobalt (2005-2010) / Pontiac G5, Pursuit (2005-2010)

After the original module is removed.

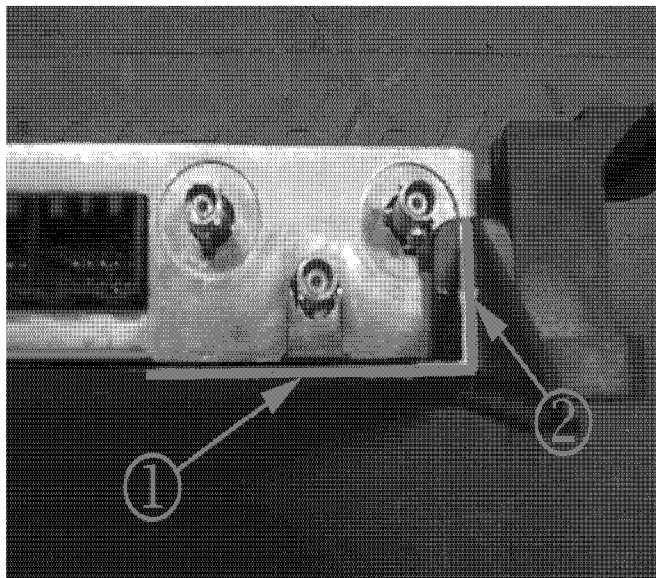

4205304

Remove only enough material from the lower edge (1) and shoulder (2) from the bracket to allow the module to seat fully.

Continue with the installation procedure.

Chevrolet Colorado (2004-2012) / GMC Canyon (2004-2012)

After the original module is removed.

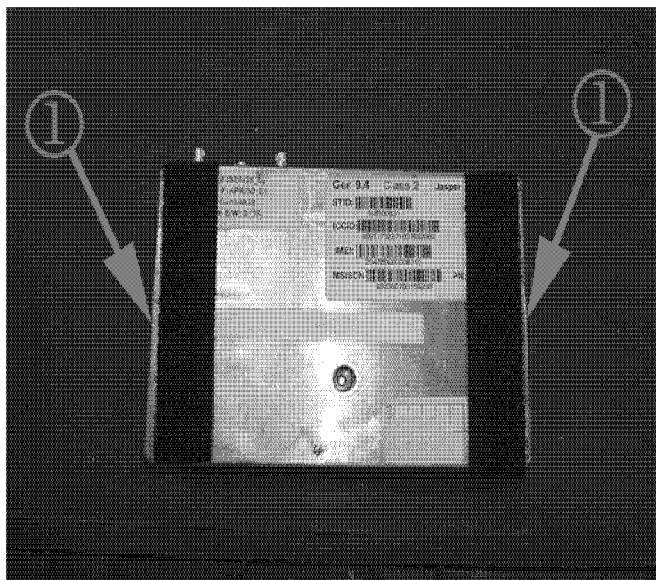

4205316

Install one side of 2" Velcro® 191195 Reclosable Loop Fastener Tape (hook and loop) or equivalent as shown above to the new OnStar® module.



4205326

Install the other side of the 2" Velcro® 191195 Reclosable Loop Fastener Tape (hook and loop) or equivalent to the OnStar® module bracket as illustrated.

Use the Reclosable Loop Fastener Tape or equivalent to secure the OnStar® module to the bracket. Continue with the installation procedure.

Chevrolet Venture (2003-2005) / Pontiac Montana (2003-2005) / Oldsmobile Silhouette (2003-2004) / Buick Terraza (2005-2007) / Chevrolet Uplander (2005-2009) / Pontiac Montana SV6 (2005-2009) / Saturn RELAY (2005-2007)

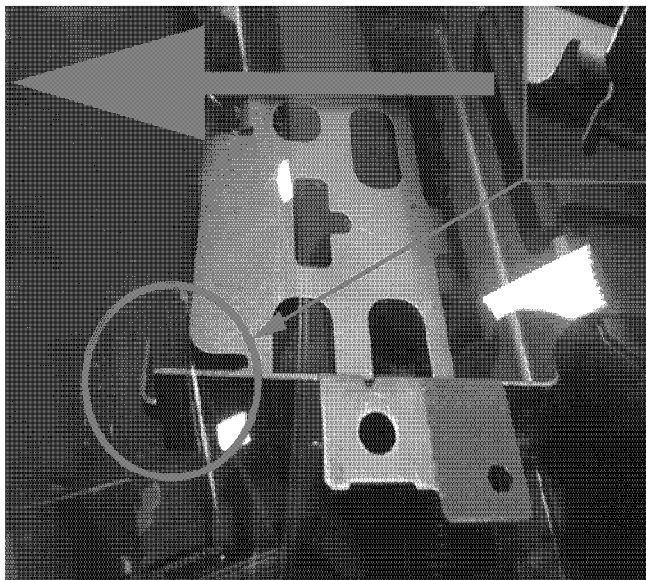

4205378

After the original module removed. Bend the OnStar® bracket tap forward as illustrated.

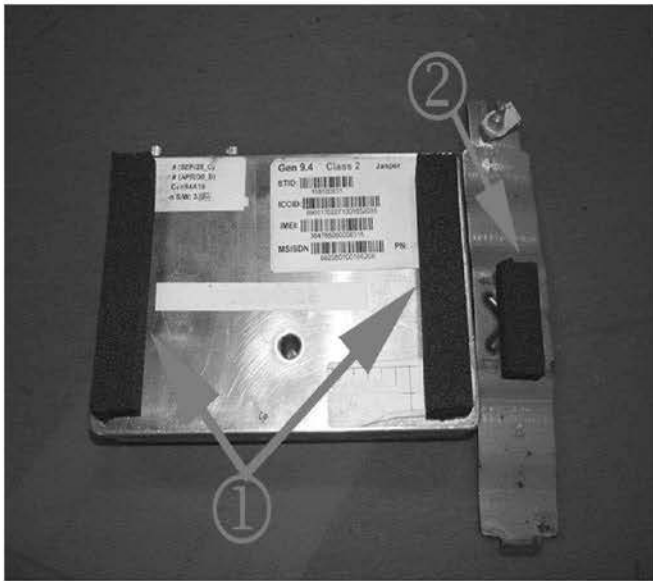

4205427

Install two strips of Kent Automotive Adhesive-Back Shim Stock 3/4" Wide X 7/16" thick or equivalent to the bottom of the OnStar® module and install a piece of foam (2) to the locking strap as illustrated.

Continue with the installation procedure.

Chevrolet Equinox (2006) / Pontiac Torrent (2006)

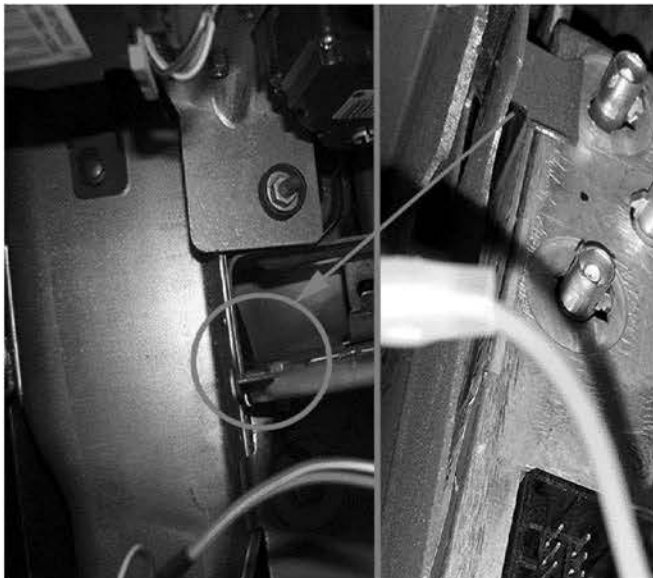

4205480

After the original module is removed.

Bend the tab, illustrated above, out of the way so the OnStar® module connector does not contact the bracket.

Continue with the installation procedure.

Saturn Astra (2008-2009)

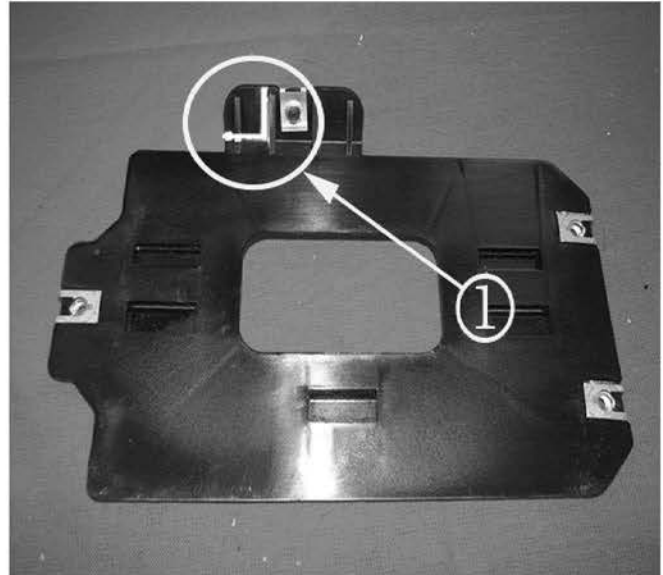

4205582

After the original module is removed.

Remove the corner of the OnStar® bracket as illustrated above.

Continue with the installation procedure.

