

ATTENTION:
 GENERAL MANAGER
 PARTS MANAGER
 CLAIMS PERSONNEL
 SERVICE MANAGER

IMPORTANT - All Service Personnel Should Read and Initial in the boxes provided, right.



QUALITY DRIVEN® SERVICE

SERVICE BULLETIN

APPLICABILITY: 2014MY Subaru Vehicles **NUMBER:** 15-168-13R
SUBJECT: 2014 Exchange Component Identification and Procedures **DATE:** 08/09/13
REVISED: 05/11/15

INTRODUCTION

This bulletin contains illustrations of exchange components and their manufacturer as well as a description of the proper exchange procedure. The exchange program policy can also be found in Sections 8.4.9 and 11.2.10 of your Service Policies and Procedures Manual found in subarunet.

8.4.9.1 AUDIO/FACE PLATE EXCHANGE PROGRAM

Within the terms of the Basic New Car Warranty and one year Replacement Part Warranty, the Exchange Program provides for replacement of a defective audio chassis and/or faceplate with an exchange unit from the manufacturer. The manufacturer will supply an exchange unit, or a new unit in the case of a “New” and “In-stock” vehicle.

Note: DO NOT disassemble an In-Dash CD Changer to retrieve any lodged CD(s) prior to returning to the manufacturer. See Section 8.4.9.4 for the policy on returning the CD(s) to the customers.

Genuine Subaru audio systems are manufactured by Panasonic and Clarion. Audio visual navigation units are manufactured by Kenwood Corporation and Fujitsu Ten Corporation. In the event an audio chassis/faceplate requires an exchange, it is not necessary to remove the unit from the vehicle. The procedures listed below should be followed:

- (1) The defective chassis should remain in the vehicle until the exchange unit is installed.
- (2) The applicable Service Center should be contacted.

The Panasonic Service Center may be contacted either by phone or by faxing a legible copy of the Panasonic Exchange Form (Section 17.15). The on-line Exchange Form is also found on Subarunet, under “Service then Forms”. The Panasonic Service Center is open from 8AM to 8PM Eastern Time.

PANASONIC	
SERVICE CENTER TELEPHONE	FAX TELEPHONE
1-800-228-0473	1-800-682-8056

continued...

<p>CAUTION: VEHICLE SERVICING PERFORMED BY UNTRAINED PERSONS COULD RESULT IN SERIOUS INJURY TO THOSE PERSONS OR TO OTHERS. Subaru Service Bulletins are intended for use by professional technicians ONLY. They are written to inform those technicians of conditions that may occur in some vehicles, or to provide information that could assist in the proper servicing of the vehicle. Properly trained technicians have the equipment, tools, safety instructions, and know-how to do the job correctly and safely. If a condition is described, DO NOT assume that this Service Bulletin applies to your vehicle, or that your vehicle will have that condition.</p>	<p>SUBARU OF AMERICA, INC. IS “ISO 14001 COMPLIANT” The international standard for excellence in Environmental Management Systems. Please recycle or dispose of automotive products in a manner that is friendly to our environment and in accordance with all local, state and federal laws and regulations.</p>
--	---

The Clarion Service Center may be contacted by phone. The Service Center is open from 8AM to 6PM Eastern.

CLARION
1-800-347-8933

The Kenwood Service Center should be contacted, preferably through their website or by faxing a legible copy of the Kenwood Exchange Request Form (Section 17.9). The on-line Exchange Form is found in Subarunet, under Service, then Forms. The Service Center is open from 9AM – 5:30PM Pacific Time. Requests arriving after 2:00PM PST are processed the following business day.

KENWOOD CORPORATION		
ON-LINE EXCHANGE FORM	FAX TELEPHONE	SERVICE CENTER TELEPHONE
www.fthgroupinc.com	1-626-333-2407	1-626-333-2435

The Fujitsu Ten Service Center may be contacted by phone, fax or e-mail. The Subaru Advance Exchange Fax Form is found in Subarunet, under Service, then Forms. The Service Center is open from 7AM – 5PM Pacific Time. Exchange Units will be shipped to the dealer via 2nd-day service.

NOTE: Activation of all XM subscription based services is the responsibility of the vehicle owner.

FUJITSU TEN		
E-MAIL ADDRESS	FAX TELEPHONE	SERVICE CENTER TELEPHONE
ftenservice@lao.ten.fujitsu.com	1-800-438-5410	1-800-237-5413

SPECIAL NOTE: Audio/Navigation Unit SD (memory) cards must be returned along with the complete unit itself for all exchange transactions made with Fujitsu Ten. Please confirm the correct SD card part number is included with the unit. The correct part number combinations of SD card and head units are provided below with the illustrations.

NOTE: In the event the vehicle is “New” and “In-stock”, inform the Service Center. A new unit will be supplied rather than an exchange unit. If the Service Center is unable to provide a new unit, immediately contact a Subaru of America, Inc. Dealer Claims Specialist at 1-866-SUBARU2 for further instructions.

Vehicles that have been placed in demo service should use exchange units only.

Replacement of an audio chassis/faceplate with a new unit, other than units supplied through the exchange program, requires authorization from Subaru of America, Inc. Dealer Claims Specialist. An authorization code will be provided and must be included upon claim submission.

- (3)** Provide the Service Center with the following information:
 Dealer Code
 Dealer Name and Address
 VIN - All 17 Characters

continued...

Date of Vehicle Sale
 Vehicle Mileage
 Caller's Name and Telephone Number
 Dealer RO Number
 Chassis Model Number, ID Code and/or the Subaru Part Number (Clarion requires the front faceplate ID number)
 Customer Complaint
 Customer Last Name

At this time, the Service Center will issue an exchange number. It is required that this number be provided upon claim submission.

Panasonic Exchange Number Example SUS0000001

Clarion Exchange Number Example... (ERS#)..... 000000001

Kenwood Exchange Number Example... (RM#)..... 0000(0)

Fujitsu Ten Exchange/Claim Id Number Example..... 4YB000000

Please note that the Fujitsu Ten Exchange Number is known as their Claim Number which is located at the bottom of the returned Exchange Fax Form.

An exchange chassis along with an exchange form will be shipped within 72 hours. If the exchange chassis is not received within 5 days, call the Service Center. Provide the operator with the exchange number when making inquiries.

(4) Install the exchange unit as soon as possible upon receipt. Return the defective chassis to the manufacturer within 30 days. Return freight charges may be claimed as sublet, provided the repair was performed under the terms of the Basic New Car Warranty or one year Replacement Part Warranty. Copies of the freight invoice should be attached to the repair order.

If the exchange unit has not been installed or the failed chassis returned within 30 days, contact the Service Center. Reference the exchange number and explain the circumstances causing the delay. An extension will be granted or the dealer will be instructed to return the exchange unit. Failure to comply will result in a “charge back” to the dealer for the cost of the exchange unit and/or the SD Card.

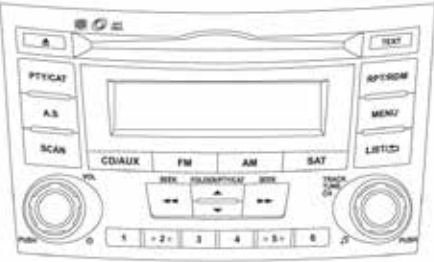
ILLUSTRATION	DESCRIPTION	MANUFACTURER	PART NUMBER
	Legacy / Outback Type A AM/FM Single disc CD player	Clarion	86201AJ61A Audio Unit Only

continued...

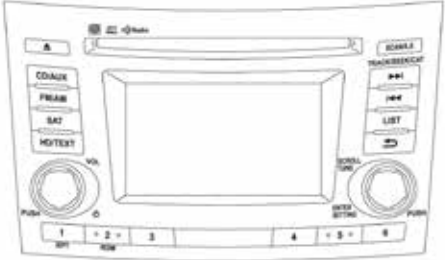
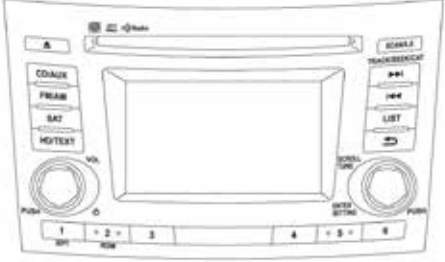
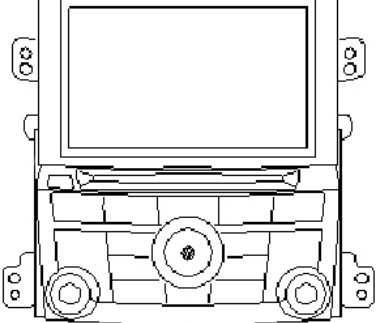
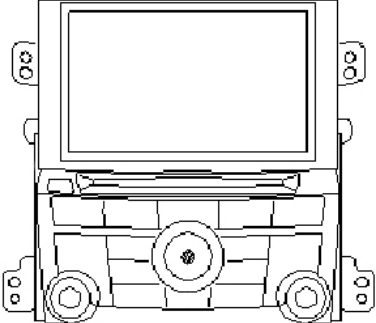
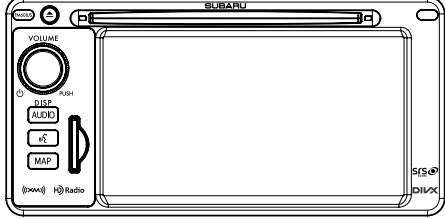
ILLUSTRATION	DESCRIPTION	MANUFACTURER	PART NUMBER
	Legacy / Outback Type B AM/FM Single Disc CD Player (Display Type) SAT	Panasonic	86201AJ65A *Audio/Faceplate Assembly (See note at bottom) Return of Assembly Includes Harness
	Legacy / Outback Type B AM/FM Single Disc CD Player (Display Type) SAT	Panasonic	86201AJ66A *Audio/Faceplate Assembly (See note at bottom) Return of Assembly Includes Harness
	Legacy/Outback Navigation & Audio Complete Head Unit (AVN) w/Aha & Harman Kardon Face Plate ID No. FE688US	Fujitsu Ten	886271AJ80A Audio with SD Card SD Card Part No. 86283AJ66A
	Legacy/Outback Navigation & Audio Complete Head Unit (AVN) w/Aha Face Plate ID No. FE699US	Fujitsu Ten	886271AJ81A Audio with SD Card SD Card Part No. 86283AJ69A
	BRZ Audio & Navigation Unit Assembly w/XM built-in and Aha Face Plate ID No. FA632US	Fujitsu Ten	86271CA630 Audio with SD Card SD Card Part No. 86283CA630

* For either Audio or Face Plate failures, order the assembly

continued...

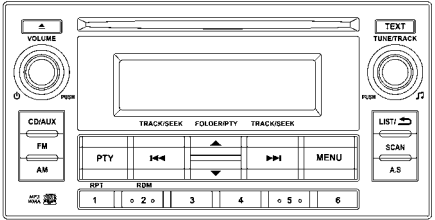
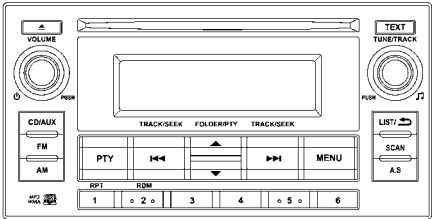
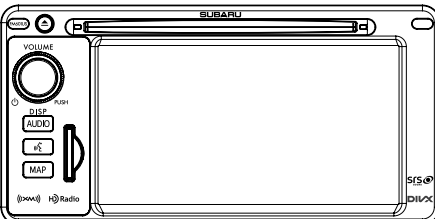
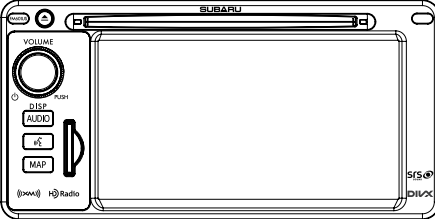
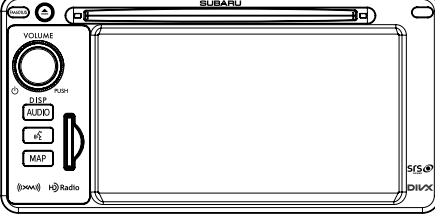
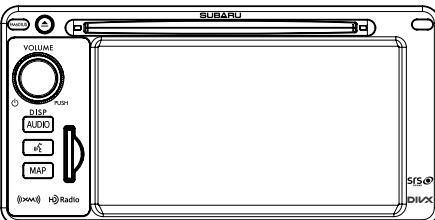
ILLUSTRATION	DESCRIPTION	MANUFACTURER	PART NUMBER
	Forester Type A AM/FM Single Disc CD Player, Bluetooth, USB	Clarion	86201SG600
	Forester Type A AM/FM Single Disc CD Player, Bluetooth, USB	Clarion	86201SG620
	Forester Audio & Navigation Unit Assembly w/XM built-in and Aha Face Plate ID No. FF605US	Fujitsu Ten	86271SG600 Audio with SD Card SD Card Part No. 86283SG600
	Forester Audio & Navigation Unit Assembly w/XM built-in, Aha & Harman Kardon Face Plate ID No. FF615US	Fujitsu Ten	86271SG610 Audio with SD Card SD Card Part No. 86283SG600
	Forester Audio & Navigation Unit Assembly w/XM built-in and Aha Face Plate ID No. FF605US	Fujitsu Ten	86271SG620 Audio with SD Card SD Card Part No. 86283SG620
	Forester Audio & Navigation Unit Assembly w/XM built-in, Aha & Harman Kardon Face Plate ID No. FF615US	Fujitsu Ten	86271SG630 Audio with SD Card SD Card Part No. 86283SG620

continued...

8.4.9.2. REAR SEAT ENTERTAINMENT EXCHANGE PROGRAM

Genuine Subaru Rear Seat Entertainment systems are manufactured by Panasonic (Tribeca) and Myron and Davis (Legacy and Outback).

Within the terms of the Basic New Car Warranty and the one year Replacement Part Warranty, the Audio / Rear Seat Entertainment Exchange Program through Panasonic provides for replacement of a defective rear seat entertainment unit (DVD player only) with an exchange unit from the manufacturer. Headphones and Rear Seat Entertainment remote control units are orderable through the Subaru Parts Dept. and not covered by this exchange program. Myron and Davis will provide an electronics module that includes the LCD screen and integrated DVD player. Headphones and the remote control units are also orderable through the Subaru Parts Dept. and not covered by this exchange program. The manufacturer will supply an exchange unit, or a new unit in the case of a “New” and “In-stock” vehicle.

In the event a rear seat entertainment unit or module requires an exchange, it is not necessary to remove the unit from the vehicle. The procedures listed below should be followed:

- (1) The defective chassis should remain in the vehicle until the exchange unit is installed.
- (2) The applicable Service Center should be contacted by either calling their toll free number or by faxing a legible copy of the Exchange Request Form.

The Panasonic Service Center may be contacted either by phone or by faxing a legible copy of the Panasonic Exchange Form (Section 17.15). The online Exchange Form is also found on Subarunet, under Service, then Forms. The Panasonic Service Center is open from 8AM to 8PM Eastern Time.

PANASONIC	
SERVICE CENTER TELEPHONE	FAX TELEPHONE
1-800-228-0473	1-800-682-8056

The Myron and Davis Service Center may be contacted by phone or by faxing a legible copy of the Myron and Davis Exchange Form (Section 17). The online Exchange Form is also found on Subarunet, under Service, then Forms. The Service Center is open from 8AM to 5PM Pacific Time.

MYRON AND DAVIS	
SERVICE CENTER TELEPHONE	FAX TELEPHONE
1-866-435-6789	1-909-796-0597

NOTE (1): In the event the vehicle is “New” and “In-stock”, inform the Service Center. A new unit will be supplied rather than an exchange unit. If the Service Center is unable to provide a new unit, immediately contact your Subaru Service Representative for further instructions.

Vehicles that have been placed in demo service should use exchange units only.

Replacement of a rear seat entertainment unit with a new unit, other than units supplied through the exchange program, requires authorization from your Subaru Service Representative (see Section 8.4.10). An authorization code will be provided and must be included upon claim submission.

continued...

NOTE (2): DO NOT disassemble a Rear Seat Entertainment Unit to retrieve a lodged DVD prior to returning to the manufacturer. See Section 8.4.9.4 for the policy on returning the DVDs to the customers.

(3) Provide the Service Center with the following information:

Dealer Code

Dealer Name and Address

VIN - All 17 Characters

Date of Vehicle Sale

Vehicle Mileage

Caller's Name and Telephone Number

Claim Number

Chassis Model Number, ID Code and/or the Subaru Part Number

Customer Complaint

Customer Last Name

At this time, the Service Center will issue an exchange number. It is required that this number be provided upon claim submission.

PANASONIC EXCHANGE NUMBER EXAMPLE..... SUS0000001

MYRON AND DAVIS EXCHANGE NUMBER



EXAMPLE..... RA(followed by 5 numerics)

Panasonic will ship an exchange chassis along with an exchange form within 72 hours. Myron and Davis will ship an exchange module along with an exchange form same day UPS 2nd Day Air when the exchange form is received by 12:00PM PST, Monday through Friday.

(4) Install the exchange unit as soon as possible upon receipt. Return the defective chassis to the manufacturer within 30 days. Return freight charges may be claimed as sublet, provided the repair was performed under the terms of the Basic New Car Warranty or the one year Replacement Part Warranty. Copies of the freight invoice should be attached to the repair order

If the exchange unit has not been installed or the failed chassis returned within 30 days, contact the Service Center. Reference the exchange number and explain the circumstances causing the delay. An extension will be granted or the dealer will be instructed to return the exchange unit. Failure to comply will result in a "charge back" to the dealer for the cost of the exchange unit.

continued...

ILLUSTRATION	DESCRIPTION	MANUFACTURER	PART NUMBER
	Legacy / Outback Headrest DVD Monitor Assembly (Left or Right)	Myron and Davis	H001SAJ320
	Legacy / Outback Aii Module	Myron and Davis	H001SAJ370

8.4.9.3 NAVIGATION SYSTEM EXCHANGE PROGRAM

Within the terms of the Basic New Car Warranty and the one year Replacement Part Warranty, the Navigation System Exchange Program provides for replacement of a defective navigation assembly and/or display screen with an exchange unit from the manufacturer. The manufacturer will supply an exchange unit, or a new unit in the case of a “New” and “In-stock” vehicle. Vehicles that have been placed in demo service should use exchange units only.

Note: DO NOT disassemble a Navigation Assembly to retrieve a lodged DVD prior to returning to the manufacturer. See Section 8.4.9.4 for the policy on returning the DVD to the customer.

Genuine Subaru navigation systems are manufactured by Kenwood Corporation and Fujitsu Ten Corporation. In the event a navigation unit or display screen requires an exchange, it is not necessary to remove the unit from the vehicle. The procedures listed below must be followed:

- 1) The defective unit should remain in the vehicle until the exchange unit is installed.
- 2) The applicable Service Center should be contacted, preferably through their website or by faxing a legible copy of the Exchange Request Form.

The Kenwood Corporation may be contacted through their website or by faxing a legible copy of the Kenwood Exchange Form (Section 17.9). The on-line Exchange Form is found in Subarunet, under Service, then Forms. Service Center is open from 9 AM – 5:30 PM Pacific Time. Requests arriving after 2:00 PM PST are processed the following business day.

KENWOOD CORPORATION		
ON-LINE EXCHANGE FORM	FAX TELEPHONE	SERVICE CENTER TELEPHONE
www.fthgroupinc.com	1-626-333-2407	1-626-333-2435

The Fujitsu Ten Service Center may be contacted by phone, fax or e-mail. The Subaru Advance Exchange Fax Form is found in Subarunet, under Service, then Forms. The Service Center is open from 7AM – 5PM Pacific Time. Exchange Units will be shipped to the dealer via 2nd-day service.

continued...

FUJITSU TEN		
E-MAIL ADDRESS	FAX TELEPHONE	SERVICE CENTER TELEPHONE
ftenservice@lao.ten.fujitsu.com	1-800-438-5410	1-800-237-5413

SPECIAL NOTE: Audio/Navigation Unit SD (memory) cards must be returned along with the complete unit itself for all exchange transactions made with Fujitsu Ten. Please confirm the correct SD card part number is included with the unit. The correct part number combinations of SD card and head units are provided below with the illustrations.

Note: In the event the vehicle is “New” and “In-stock”, indicate this on the exchange form. A new unit will be supplied rather than an exchange unit.

- 3) Kenwood or Fujitsu Ten will either ship an exchange unit or reject the request by the next business day.

Upon acceptance of the Exchange Request, Kenwood or Fujitsu Ten will ship the exchange unit directly to the dealer via second day air. Documentation shipped with the unit will include an order number or an RMA Number (Kenwood) or an Exchange Number (Fujitsu Ten). It is required that these numbers provided upon claim submission.

KENWOOD EXCHANGE NUMBER EXAMPLE... (RMA #)... 0000(0)

FUJITSU TEN EXCHANGE/ CLAIM ID NUMBER EXAMPLE... 4YB000000

If the exchange is rejected, Kenwood or Fujitsu Ten will promptly notify the dealer of reason for rejection. Kenwood or Fujitsu Ten may reject the request if the Exchange Request Form has not been properly and legibly completed.

- 4) The dealer must return the failed component to Kenwood or Fujitsu Ten in the same approved packaging that the exchange unit arrived in. A hard copy of the printout from the on-line order or the Exchange Request Form must be included in the core return package. Return freight charges may be claimed as sublet, provided the repair was performed under the terms of the Basic New Car Warranty. Copies of the freight invoice should be attached to the repair order.

If replacement DVD(s) are supplied with the exchange, the original navigation DVD(s) must accompany the returned unit or a charge will be incurred.

Failure to use proper packaging could result in a “charge back” for the cost of the exchange unit and shipping.

If the exchange component has not been installed or returned to Kenwood or Fujitsu Ten within 30 days from the receipt of the exchange unit, the dealer will receive a “charge back” for the cost of the exchange unit and/or the SD Card with shipping.

continued...

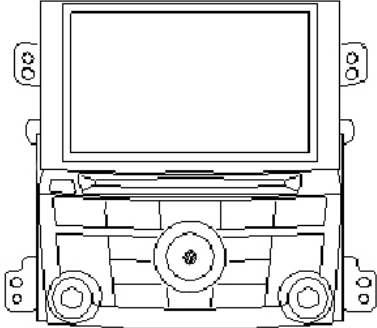
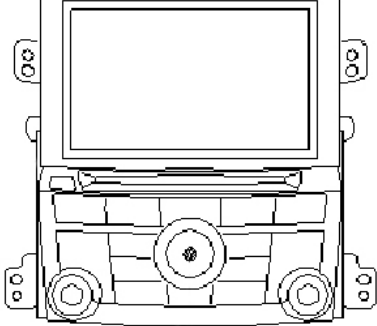
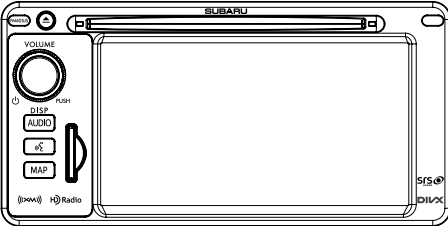
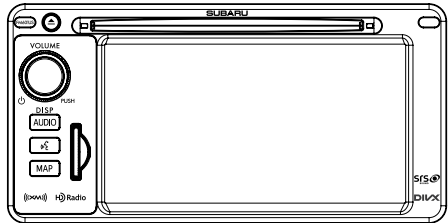
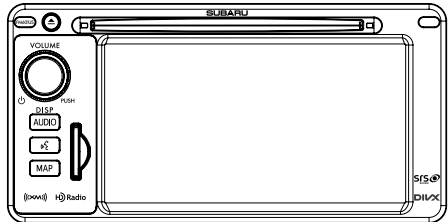
ILLUSTRATION	DESCRIPTION	MANUFACTURER	PART NUMBER
	Legacy / Outback Navigation & Audio Complete Head Unit (AVN) w/Aha and Harman Kardon Face Plate ID No. FB688US	Fujitsu Ten	86271AJ80A Audio with SD Card SD Card Part No. 86283AJ66A
	Legacy / Outback Navigation & Audio Complete Head Unit (AVN) w/Aha and Harman Kardon Face Plate ID No. FE699US	Fujitsu Ten	86271AJ81A Audio with SD Card SD Card Part No. 86283AJ69A
	BRZ Audio & Navigation Unit Assembly w/XM built-in w/Aha Face Plate ID No. FA632US	Fujitsu Ten	86271CA630 Audio with SD Card SD Card Part No. 86283CA630
	Forester Audio & Navigation Unit Assembly w/XM built-in and Aha Face Plate ID No. FF605US	Fujitsu Ten	86271SG600 Audio with SD Card Exchange SD Card Part No. 86283SG600
	Forester Audio & Navigation Unit Assembly w/XM built-in, Aha & Harman Kardon Face Plate ID No. FF615US	Fujitsu Ten	86271SG610 Audio with SD Card Exchange SD Card Part No. 86283SG600

continued...

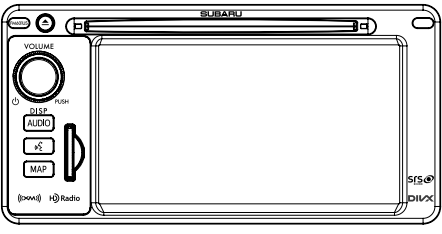
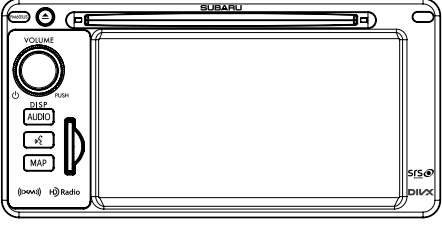
ILLUSTRATION	DESCRIPTION	MANUFACTURER	PART NUMBER
	Forester Audio & Navigation Unit Assembly w/XM built-in and Aha Face Plate ID No. FF605US	Fujitsu Ten	86271SG620 Audio with SD Card Exchange SD Card Part No. 86283SG620
	Forester Audio & Navigation Unit Assembly w/XM built-in, Aha & Harman Kardon Face Plate ID No. FF615US	Fujitsu Ten	86271SG630 Audio with SD Card Exchange SD Card Part No. 86283SG620

8.4.9.4. RETURN OF LODGED CD/DVD(S)

In the event a DVD/ CD(s) becomes lodged in the In-Dash CD Changer, Rear Seat Entertainment Unit or Navigation Assembly, do not disassemble the unit to retrieve the DVD/ CD(s). Please use the following procedure:

- (1) Follow the normal exchange procedures for requesting a replacement unit. In the case of Navigation DVDs, notify the manufacturer at the time the exchange unit is requested that the DVD is lodged in the unit. A new DVD will be supplied with the exchange unit.
- (2) For all DVD/CD(s) other than Navigation DVDs, record a daytime telephone number where the customer can be reached and retain in customer's file.
- (3) Remove the defective unit from the vehicle and return it to the manufacturer. DVD/ CD(s) that have been successfully removed by the manufacturer will be returned directly to the dealer within 10 calendar days. It is the dealer's responsibility to notify the customer when the DVD/CD(s) are returned.

In the event a DVD/CD(s) has been damaged (except Navigation DVDs); the manufacturer will reimburse the customer through the dealer at \$15.00 per damaged CD or \$20.00 per damaged DVD. Panasonic will forward a check for this reimbursement to the dealer. The dealer must in turn reimburse the customer. Only commercially produced DVD/ CD(s) can be included in the reimbursement program.

8.4.9.5. SATELLITE RADIO EXCHANGE PROGRAM

Within the terms of the Basic New Car Warranty, and the one year Replacement Part Warranty, the Satellite Radio Exchange Program provides for replacement of a defective control module with an exchange module from the manufacturer. The manufacturer will supply an exchange unit, or a new unit in the case of a "New" and "In-stock" vehicle.

Genuine Subaru Satellite Radio Accessories are manufactured by Clarion. In the event the control module requires an exchange, it is not necessary to remove the unit from the vehicle.

continued...

The procedures listed below should be followed:

- (1) The defective module should remain in the vehicle until the exchange unit is installed.
- (2) The Clarion Service Center should be contacted. The Service Center is open from 8 AM - 6 PM Eastern Time:

CLARION
1-800-347-8933

The Fujitsu Ten Service Center may be contacted by phone, fax or e-mail. The Subaru Advance Exchange Fax Form is found in Subarunet, under Service, then Forms. The Service Center is open from 7AM – 5PM Pacific Time. Exchange Units will be shipped to the dealer via 2nd-day service.

Note: Activation of all XM subscription based services is the responsibility of the vehicle owner.

FUJITSU TEN		
E-MAIL ADDRESS	FAX TELEPHONE	SERVICE CENTER TELEPHONE
ftenservice@lao.ten.fujitsu.com	1-800-438-5410	1-800-237-5413

SPECIAL NOTE: Audio/Navigation Unit SD (memory) Cards must be returned along with the complete unit itself for all exchange transactions made with Fujitsu Ten. Please confirm the correct SD card part number is included with the unit. The correct part number combinations of SD card and head units are provided below with the illustrations.

Note: In the event the vehicle is “New” and “In-stock”, inform the Service Center. A new unit will be supplied rather than an exchange unit. If the Service Center is unable to provide a new unit, immediately contact a Subaru of America, Inc. Dealer Claims Specialist at 1-866-SUBARU2 for further instructions.

Vehicles that have been placed in demo service should use exchange units only.

Replacement of the control module with a new unit, other than units supplied through the exchange program, requires authorization from Subaru of America, Inc. Dealer Claims Specialist. An authorization code will be provided and must be included upon claim submission.

- (3) Provide the Service Center with the following information:

- Dealer Code
- Dealer Name and Address
- VIN - All 17 Characters
- Vehicle Year
- Vehicle Model
- Date of Vehicle Sale
- Vehicle Mileage
- Subaru Part Number
- Customer Complaint
- Customer Last Name

continued...

At this time, the Service Center will issue an exchange number. It is required that this number be provided upon claim submission.

Clarion Exchange Number Example....(ERS#)... 000000001

Fujitsu Ten Exchange/Claim Id Number Example ...4YB000000

An exchange module along with an exchange form will be shipped within 72 hours. If the exchange module is not received within 5 days, call the Service Center. Provide the operator with the exchange number when making inquiries.



- (4) Install the exchange unit as soon as possible upon receipt. Return the defective module to the manufacturer within 30 days. Return freight charges may be claimed as sublet, provided the repair was performed under the terms of the Basic New Car Warranty. Copies of the freight invoice should be attached to the repair order.

If the exchange unit has not been installed or the failed module returned within 30 days, contact the Service Center. Reference the exchange number and explain the circumstances causing the delay. An extension will be granted or the dealer will be instructed to return the exchange unit. Failure to comply will result in a “charge back” to the dealer for the cost of the exchange unit.

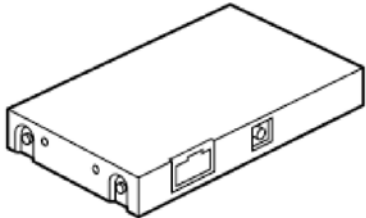
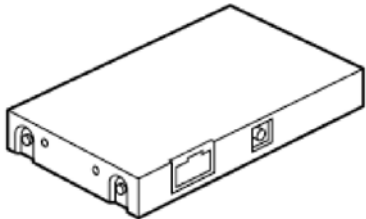
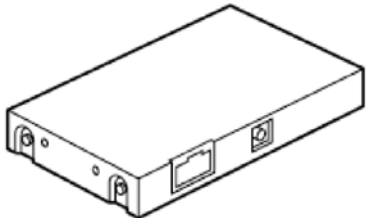
Note: Activation of all subscription based services is the responsibility of the vehicle owner.

ILLUSTRATION	DESCRIPTION	MANUFACTURER	PART NUMBER
	Legacy / Outback Sirius Satellite Tuner Module	Clarion	H621SFG021
	Forester Sirius Satellite Tuner Module	Clarion	H621SFG020
	Legacy / Outback / Forester XM Satellite Tuner Module	Clarion	H621SXA120

continued...

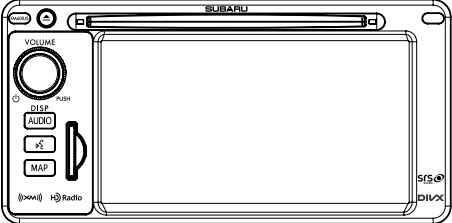
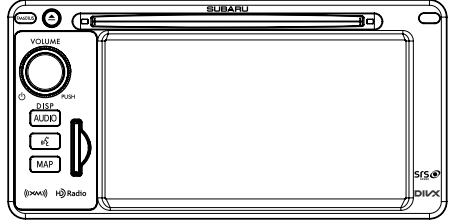
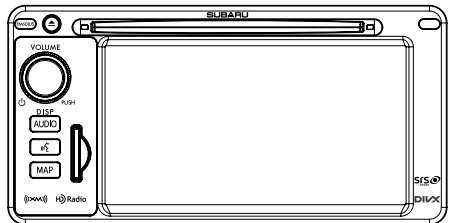
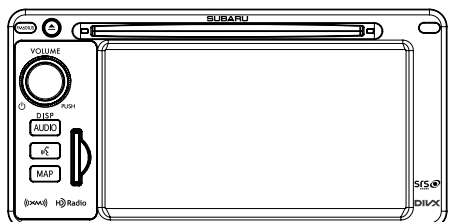
ILLUSTRATION	DESCRIPTION	MANUFACTURER	PART NUMBER
	Legacy/Outback Navigation & Audio Complete Head Unit (AVN) w/Aha & Harman Kardon Face Plate ID No. FE688US	Fujitsu Ten	86271AJ80A Audio with SD Card SD Card Part No. 86283AJ66A
	Legacy/Outback Navigation & Audio Complete Head Unit (AVN) w/Aha Face Plate ID No. FE699US	Fujitsu Ten	86271AJ81A Audio with SD Card SD Card Part No. 86283AJ69A
	BRZ Audio & Navigation Unit Assembly w/XM built-in w/Aha Face Plate ID No. FA632US	Fujitsu Ten	86271CA630 Audio with SD Card SD Card Part No. 86283CA630
	Forester Audio & Navigation Unit Assembly w/XM built-in and Aha Face Plate ID No. FF605US	Fujitsu Ten	86271SG600 Audio with SD Card SD Card Part No. 86283SG600
	Forester Audio & Navigation Unit Assembly w/XM built-in, Aha & Harman Kardon Face Plate ID No. FF615US	Fujitsu Ten	86271SG610 Audio with SD Card SD Card Part No. 86283SG600
	Forester Audio & Navigation Unit Assembly w/XM built-in and Aha Face Plate ID No. FF605US	Fujitsu Ten	86271SG620 Audio with SD Card SD Card Part No. 86283SG620

continued...

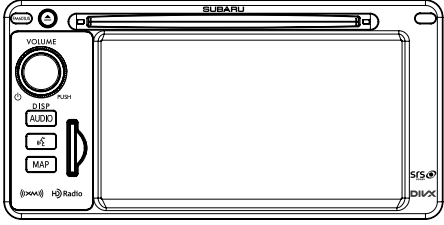
ILLUSTRATION	DESCRIPTION	MANUFACTURER	PART NUMBER
	Forester Audio & Navigation Unit Assembly w/XM built-in, Aha & Harman Kardon Face Plate ID No. FF615US	Fujitsu Ten	86271SG630 Audio with SD Card SD Card Part No. 86283SG620

8.4.9.6 POWER AMPLIFIER EXCHANGE PROGRAM

Within the terms of the Basic New Car Warranty and the one year Replacement Part Warranty, the Power Amplifier Exchange Program provides for replacement of a defective amplifier with an exchange unit. All amplifiers provided through the exchange program are new units.

Genuine Subaru amplifier units are manufactured by Harman Becker. In the event an amplifier assembly requires an exchange, it is not necessary to remove the unit from the vehicle. The procedures listed below should be followed:

- (1) The defective unit should remain in the vehicle until the exchange unit is installed.
- (2) The applicable Service Center should be contacted. Harman Becker Service Center is open from 8 AM to 8 PM Eastern Time.

Harman Becker
1-800-448-0944

- (3) Provide the Service Center with the following information:

- Dealer Code
- Dealer Name and Address
- VIN - All 17 Characters
- Date of Vehicle Sale
- Vehicle Mileage
- Caller's Name and Telephone Number
- Claim Number
- Chassis Model Number, ID Code and/or the Subaru Part Number
- Customer Complaint
- Customer Last Name

At this time, the Service Center will issue an exchange number. It is required that this number be provided upon claim submission.

Harman Becker Exchange Number Example...4MW741

R.A. Number (1 Digit 2 Letters 3 Digits)

An exchange unit along with an exchange form and return shipping label will be shipped within 48 hours. If the exchange unit is not received within 5 days, call the Service Center.

Provide the operator with the exchange number when making inquiries.

continued...

(4) Install the exchange unit as soon as possible upon receipt. Return the defective unit to the manufacturer within 30 days. All exchange units have return shipping labels included and should be returned in the same packaging the exchange unit arrived in.

If the exchange unit has not been installed or the failed unit returned within 30 days, contact the Service Center. Reference the exchange number and explain the circumstances causing the delay. An extension will be granted or the dealer will be instructed to return the exchange unit.

Failure to comply will result in a “charge back” to the dealer for the cost of the exchange unit.

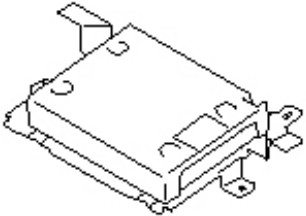
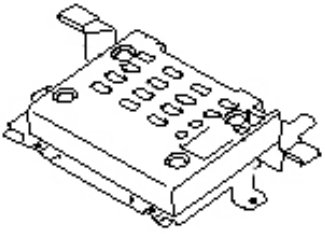
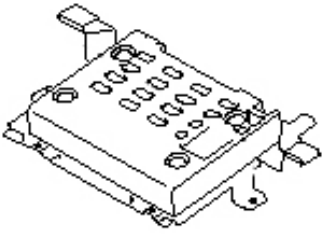
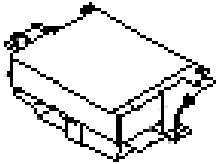
ILLUSTRATION	DESCRIPTION	MANUFACTURER	PART NUMBER
	Forester Power Amplifier Assy	Harman Kardon	86221SG010
	Legacy/Outback Power Amplifier Assy (Base Models)	Harman Kardon	86221AJ20A
	Legacy/Outback Power Amplifier Assy (Limited Models)	Harmon Kardon	86221AJ21A
	Tribeca Power Amplifier Assy (Limited & Touring Models)	Harmon Kardon	86221XA20A

SIRIUS XM WARRANTY EXCHANGE PROCESS

If you need to perform a warranty exchange on any radio that is factory equipped with satellite radio, please follow the below instructions. Going through the below process will ensure the any fees for the new radio is waived and will ensure your customer continues to receive their satellite radio programming without any interruption of service.

Step 1. Call SiriusXM Dealer Support at 1-800-852-9696 and let the agent know you are doing a warranty exchange on a Subaru vehicle.

continued...

Step 2. Provide the agent with the old Radio ID and ask them to transfer the service on this radio to the new Radio ID. Confirm with the agent that the old Radio ID has been deactivated.

(To find the Radio ID, go into satellite radio mode and tune to channel “0”, the Radio ID will display for you, it will be 8 alpha-numeric characters long).

Step 3. Confirm which services you are transferring e.g. Audio only or Audio and Traffic.

Step 4. Ask the SXM Dealer support agent to send an activation signal to the new radio and confirm the radio is working. Dealers can also perform a signal refresh if necessary by entering in the Radio ID into the following url. www.siriusxm.com/oemrefresh

11.2.10 AUDIO COMPONENT OUT-OF-WARRANTY EXCHANGE / REPAIR PROGRAM

Vehicles outside the terms of the New Car Basic or Parts Warranties may utilize the Audio Exchange/Repair Program which is to be referenced as an “Out-of Warranty Exchange Program”. Subaru Added Security Gold Plus customers are entitled to this “out-of-warranty” exchange program when the failure meets the terms of the Agreement.

The out-of-warranty exchange program is intended to enhance customer satisfaction by providing a prompt exchange with a quality factory serviced audio unit which has been refurbished to the highest standards.

All out-of-warranty orders will be subject to availability. In case of low stock, “in-warranty” orders will take priority over “out-of-warranty” orders. In general, this program is for internal failures and does not include exchanges for damage (spilled liquid, scratches, etc.) Speak with the manufacturer to determine exchange eligibility.

Out of Warranty Exchange Program procedures are outlined below. Please have the following information available when contacting the Service Center.

Dealer Code

Dealer Name and Address

VIN – All 17 Characters

Date of Vehicle Sale

Vehicle Mileage

Caller’s Name and Telephone Number

Claim Number

Chassis Model Number, ID Code and/or the Subaru Part Number (Clarion requires the front faceplate ID Number)

Customer Complaint

Customer Last Name

Clarion: 1-800-347-8933

- The program includes 2002 and later model years based on availability
- Exchange cores will be shipped UPS Ground within 72 hours.
- Clarion offers a 1 year manufacturer’s warranty on these exchange units.
- Clarion will invoice the dealer for the cost of the exchange unit.
- Shipping charges for return of the core is the responsibility of the dealership.

continued...

- Cores must be returned to Clarion within 30 days
- Delinquent cores will be invoiced to SOA who in turn will issue a debit to the dealership
- There will be a restocking fee of 20% for all unused returned cores. Dealers will be invoiced by Clarion and are to make payment directly to Clarion for this fee.

Panasonic: 1-800-228-0473

- The program includes 2002 and later model years based on availability
- Exchange cores will be shipped UPS Ground within 72 hours
- Panasonic offers a 1 year manufacturer's warranty on these exchange units.
- Dealers will be invoiced by Panasonic for the cost of the exchange unit
- Payments are to be made directly to Panasonic
- Shipping charges for return of the core is the responsibility of the dealership
- Cores must be returned to Panasonic within 30 days

Kenwood: 1-626-333-2435

NOTE: Kenwood does not offer an "Out of Warranty" exchange program; however, they do offer an "Out of Warranty" repair program.

- The Kenwood Service Center should be contacted preferably through their web-site www.fthgroupinc.com
- The dealer places the repair request with the Kenwood Service Center and pays a minimum analysis and shipping fee.
- The dealer removes the unit from the vehicle and sends it to the Kenwood Service Center for repair.
- The Kenwood Service Center analyzes the unit and informs the dealer of additional repair costs. Repair costs will vary depending on the condition of the unit.
- If the customer does not agree to additional costs, the unit is returned to the dealer "as is" with no additional charges.
- If the customer agrees to the repair, Kenwood invoices the dealer and payments are to be made by the dealer directly to Kenwood.
- The Kenwood Service Center repairs the unit and returns it to the dealer.

Fujitsu Ten 1-800-237-5413

- The program includes 2010 and later model years based on availability
- Exchange cores will be shipped UPS Ground or 2nd Day Air within 72 hrs.
- Fujitsu Ten offers a 1 yr. manufacturer's warranty on these exchange units
- Fujitsu Ten will invoice the dealer for the cost of the exchange unit
- Shipping charges for return of the core is the responsibility of the dealership
- Cores must be returned to Fujitsu Ten within 30 days
- Delinquent cores will be invoiced to SOA who in turn will debit the dealership
- There will be a restocking fee of 20% for all unused returned cores. Dealers will be invoiced by Fujitsu Ten and are to make payment directly to Fujitsu Ten for this fee.